



US00D800977S

(12) **United States Design Patent**
Dammkoehler et al.

(10) **Patent No.:** **US D800,977 S**

(45) **Date of Patent:** **** Oct. 24, 2017**

(54) **VACUUM CLEANER**

(71) Applicant: **Alfred Kaercher GmbH & Co. KG,**
Winnenden (DE)

(72) Inventors: **Denis Dammkoehler,** Backnang (DE);
Zheyi Jin, Schwaikheim (DE)

(73) Assignee: **Alfred Kaercher GmbH & Co. KG,**
Winnenden (DE)

(**) Term: **15 Years**

(21) Appl. No.: **29/570,748**

(22) Filed: **Jul. 12, 2016**

(30) **Foreign Application Priority Data**

Jan. 28, 2016 (WO) 954612401

(51) **LOC (10) Cl.** **15-05**

(52) **U.S. Cl.**
USPC **D32/18**

(58) **Field of Classification Search**
USPC D32/17-18, 21, 31
CPC A47L 5/24; A47L 5/28; A47L 7/0038
See application file for complete search history.

(56) **References Cited**

U.S. PATENT DOCUMENTS

D205,994 S * 10/1966 Ota D32/18
D360,502 S * 7/1995 Hollinger D32/18

5,938,410 A * 8/1999 Lee A47L 5/14
15/330
D421,513 S * 3/2000 Hsu D32/18
D481,841 S * 11/2003 Hsu D32/18
D553,810 S * 10/2007 Lau D32/18
D731,720 S * 6/2015 Gidwell D32/18
D741,558 S * 10/2015 Kerr D32/18
D745,231 S * 12/2015 Niedzwecki D32/18
D781,011 S * 3/2017 Bu D32/18

* cited by examiner

Primary Examiner — Ruth McInroy

(74) *Attorney, Agent, or Firm* — Lipsitz & McAllister,
LLC

(57) **CLAIM**

The ornamental design for a vacuum cleaner, as shown and described.

DESCRIPTION

FIG. 1 is a front, top and left side perspective view of a vacuum cleaner showing the new design; FIG. 2 is a front, top and right side perspective view thereof; FIG. 3 is a front elevational view thereof; FIG. 4 is a left side elevational view thereof; FIG. 5 is a rear elevational view thereof; FIG. 6 is a right side elevational view thereof; and, FIG. 7 is a top plan view thereof.

1 Claim, 7 Drawing Sheets

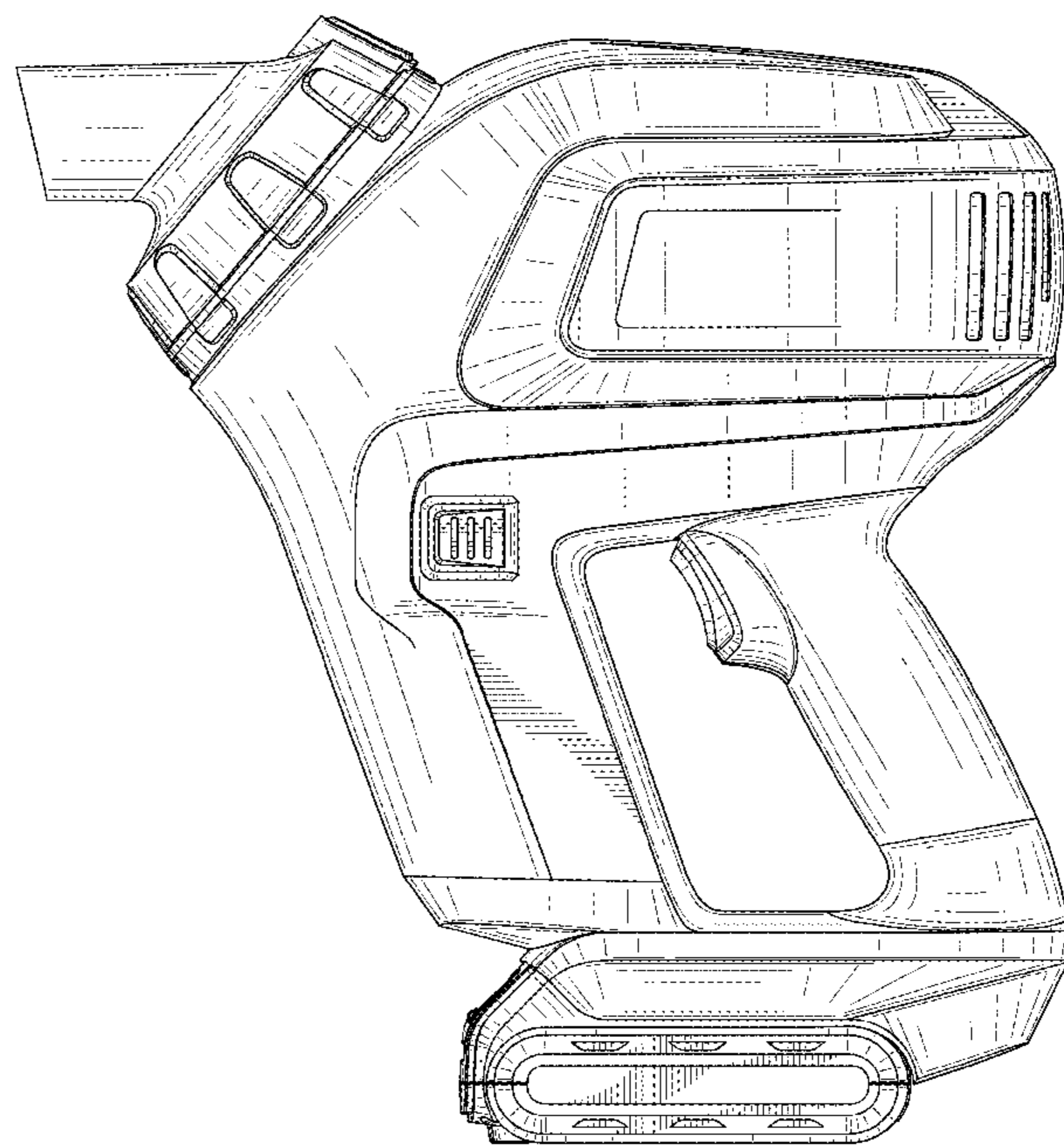
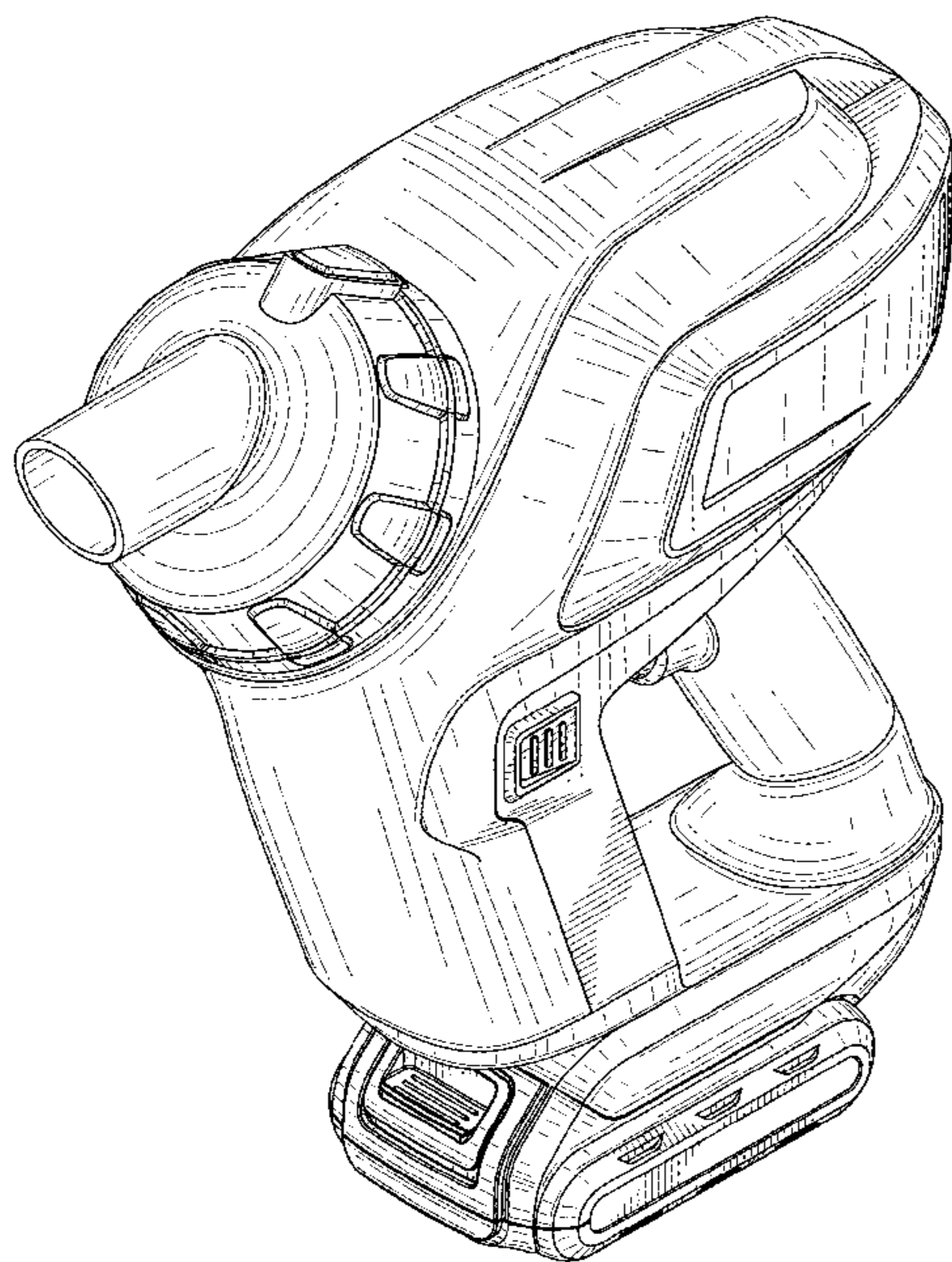

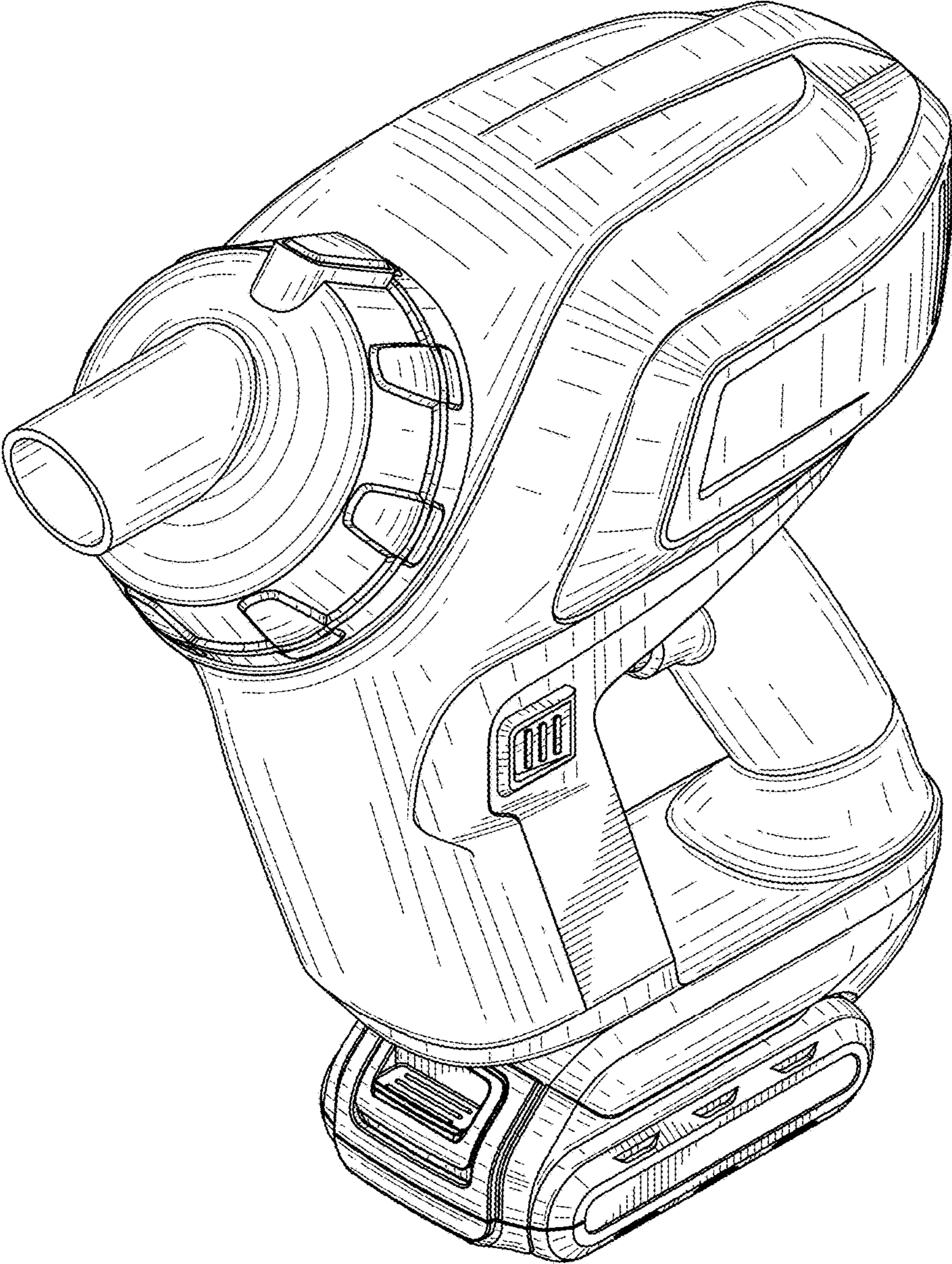

FIG.1

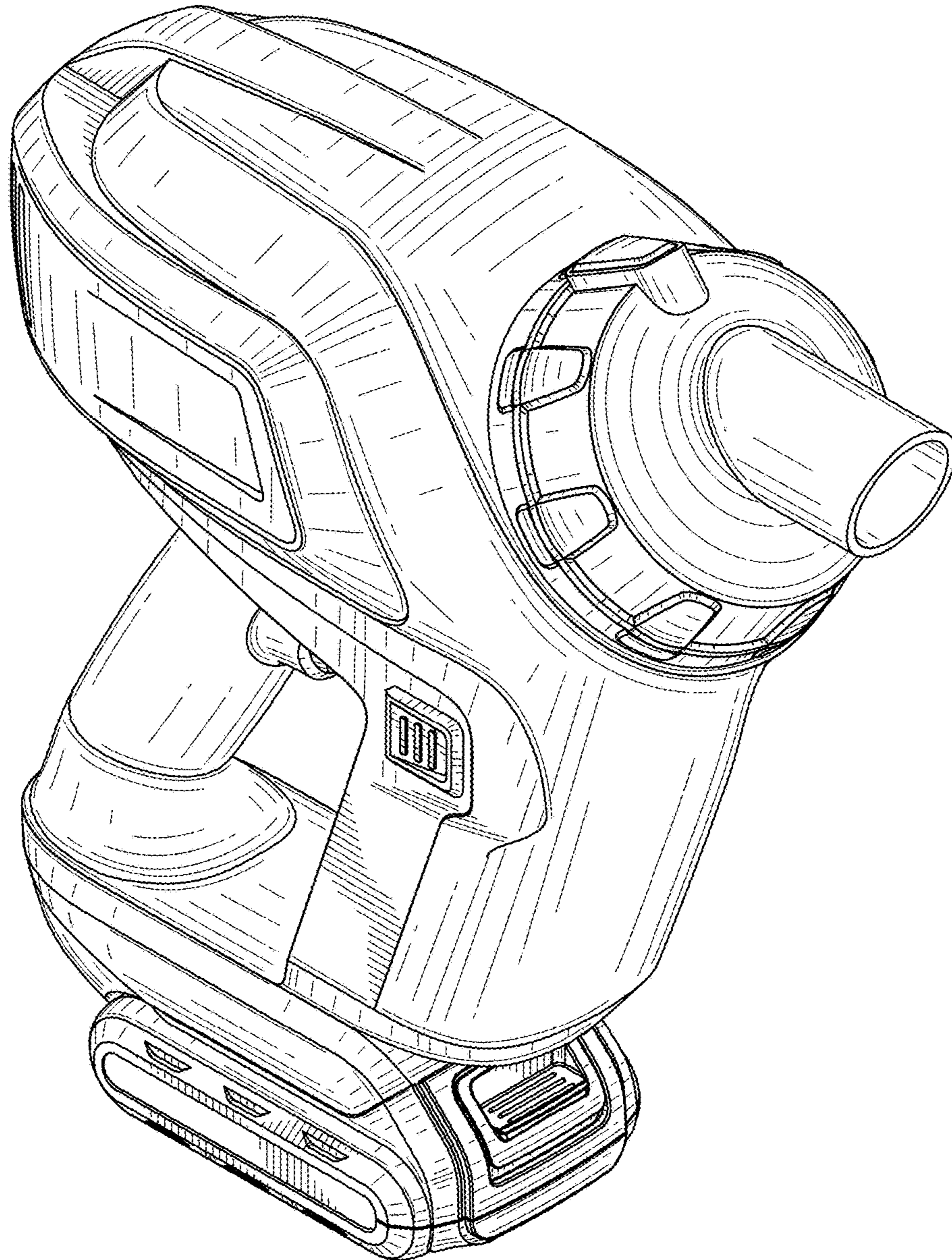

FIG.2

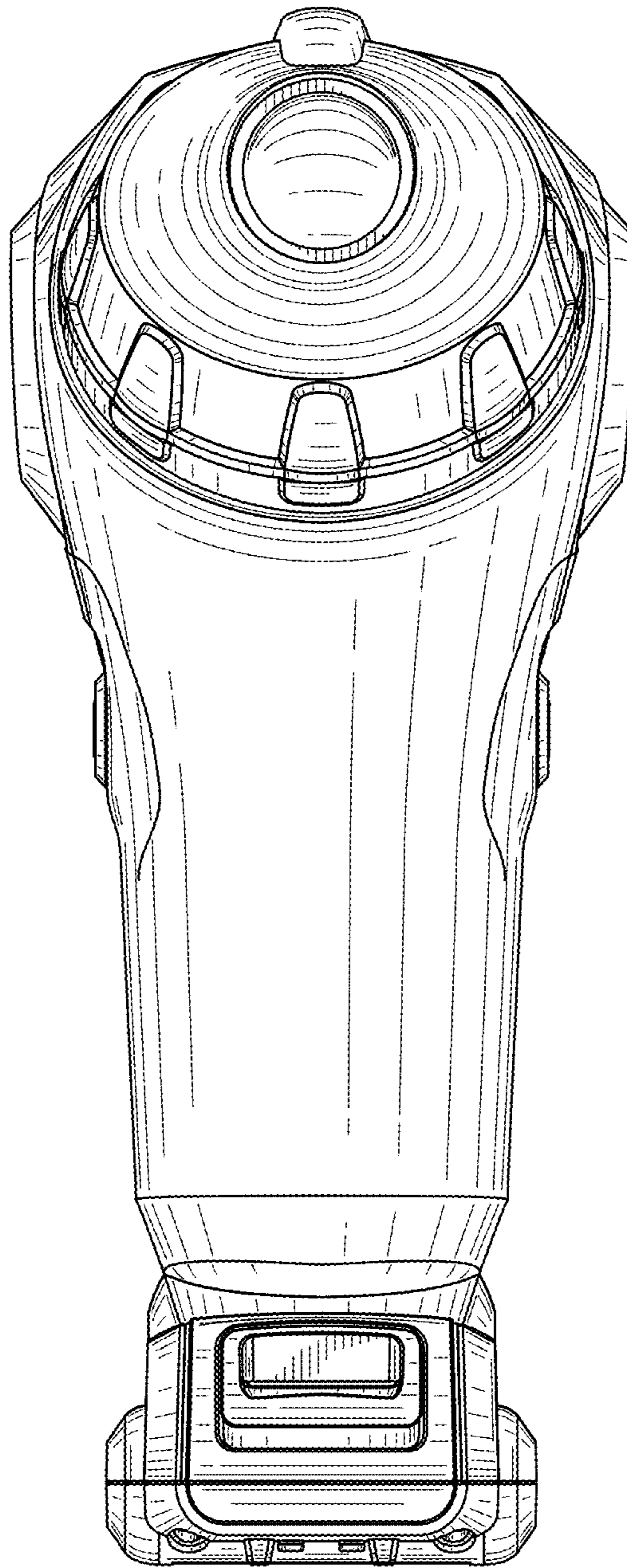

FIG.3

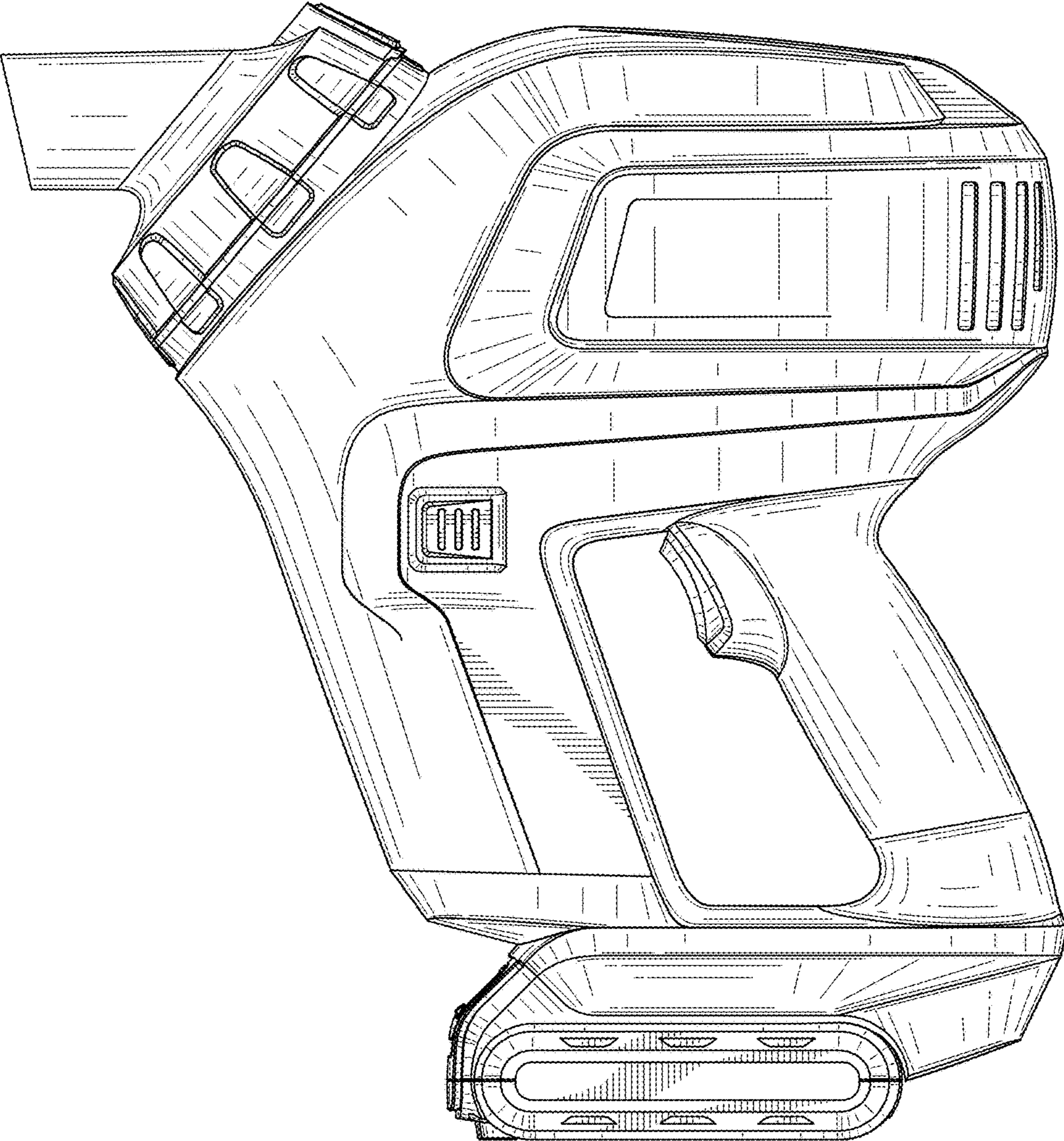

FIG.4

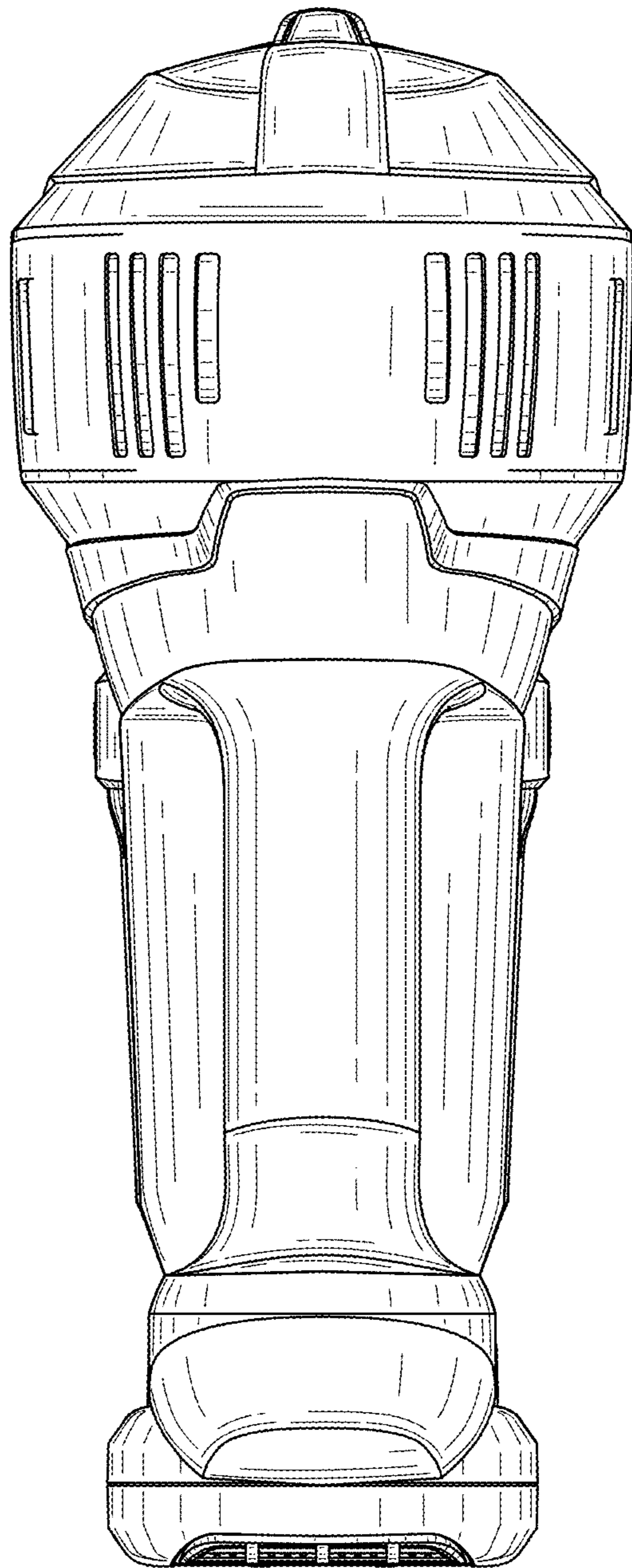

FIG.5

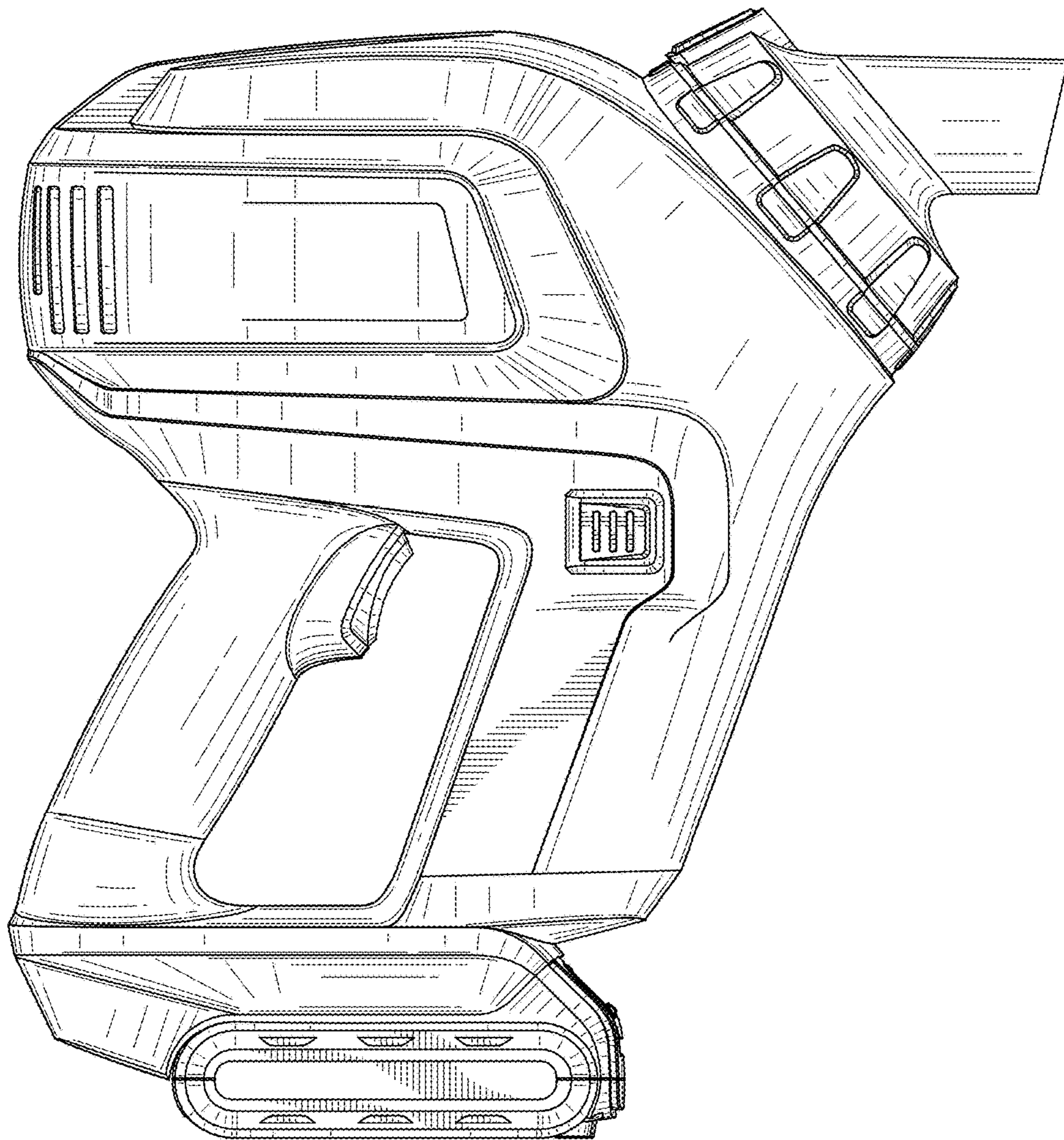

FIG.6

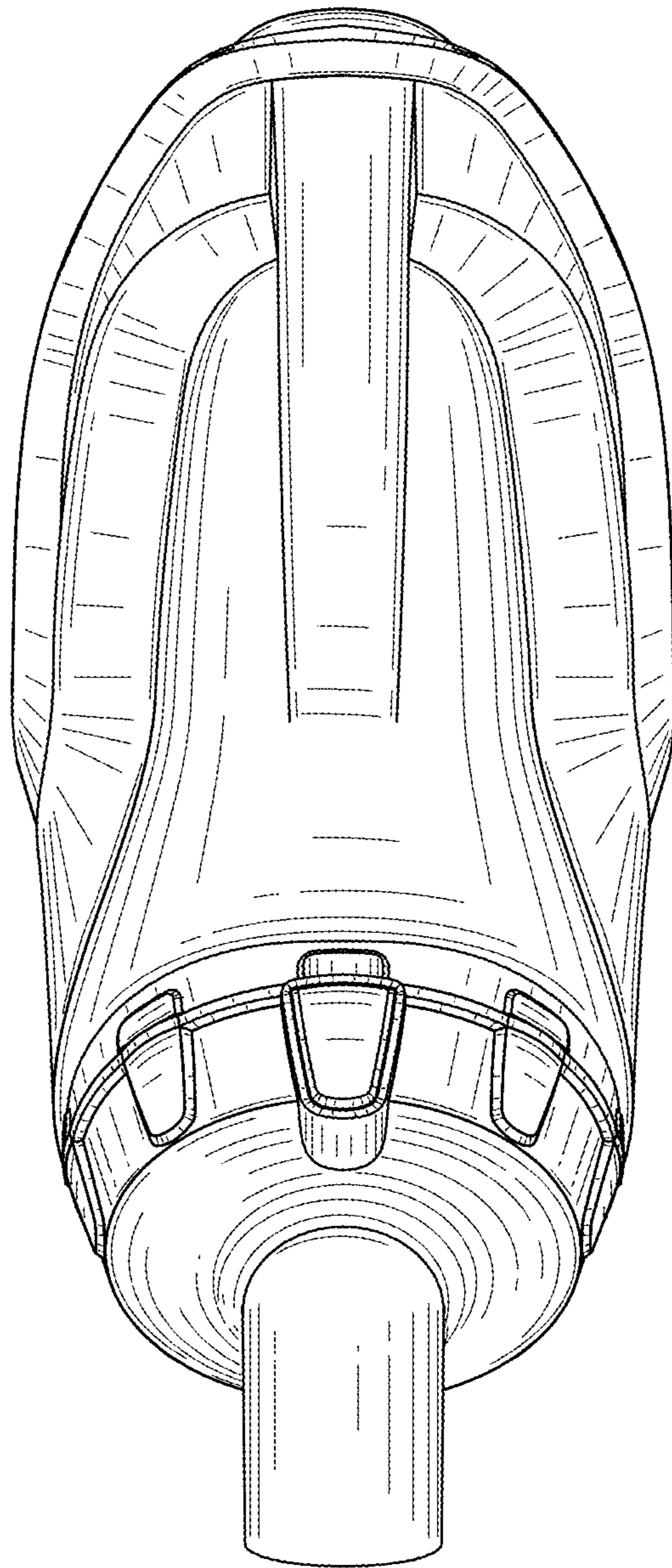

FIG.7