

US00D800966S

(12) **United States Design Patent** (10) **Patent No.:** **US D800,966 S**
Silva (45) **Date of Patent:** **** Oct. 24, 2017**

(54) **CONTAINER**
(71) Applicant: **Rea.deeming Beauty, Inc.**, Bethlehem, PA (US)
(72) Inventor: **Rea Ann Silva**, Bethlehem, PA (US)

(73) Assignee: **REA.DEEMING BEAUTY, INC.**, Bethlehem, PA (US)

(**) Term: **15 Years**

(21) Appl. No.: **29/556,321**

(22) Filed: **Feb. 29, 2016**

(51) **LOC (10) Cl.** **28-03**

(52) **U.S. Cl.**
USPC **D28/79; D28/82**

(58) **Field of Classification Search**
USPC D28/76-84, 73; D9/643, 600
CPC A45D 33/00; A45D 33/006-33/16; A45D 33/18; A45D 33/20-33/24; A45D 34/00; A45D 34/007; A45D 40/00; A45D 40/0006; A45D 40/0012; A45D 40/0018; A45D 40/22-40/24; A45D 40/10; A45D 40/105; A45D 2200/05; A45D 2200/051
See application file for complete search history.

(56) **References Cited**

U.S. PATENT DOCUMENTS

1,743,611 A * 1/1930 Larson A45D 33/006
132/294
3,188,157 A * 6/1965 Rand A45D 33/00
220/23.8
D299,561 S * 1/1989 Bakic D28/78
D303,163 S * 8/1989 Bakic D28/78
D339,882 S * 9/1993 Chevassus D28/82
D355,486 S * 2/1995 Ikeda D24/133
D424,751 S * 5/2000 Kudo D28/78
D424,753 S * 5/2000 Grossnickle D28/82

D599,958 S * 9/2009 Washington D28/82
8,778,430 B2 * 7/2014 Dietrich B65B 5/06
426/110
D713,095 S * 9/2014 Bishop D28/10
D735,947 S * 8/2015 Reyes D28/79
2007/0017915 A1 * 1/2007 Weder B65D 21/086
220/4.21

* cited by examiner

Primary Examiner — Jennifer Rivard

(74) *Attorney, Agent, or Firm* — Brooks Acordia IP Law, PC; Pejman Yedidsion

(57) **CLAIM**

The ornamental design for a container, as shown and described.

DESCRIPTION

FIG. 1 is a front elevational view of a container showing the new design;
FIG. 2 is a rear elevational view of the embodiment of FIG. 1;
FIG. 3 is a right side elevational view of the embodiment of FIG. 1;
FIG. 4 is a left side elevational view of the embodiment of FIG. 1;
FIG. 5 is a top plan view of the embodiment of FIG. 1;
FIG. 6 is a bottom plan view of the embodiment of FIG. 1;
FIG. 7 is a perspective view of the embodiment of FIG. 1;
FIG. 8 is a front elevational view of the embodiment of FIG. 1 in an alternate position;
FIG. 9 is a rear elevational view of the embodiment of FIG. 1 in an alternate position; and,
FIG. 10 is a perspective view of the embodiment of FIG. 1 in an alternate position.
The broken lines illustrate portions of the container and form no part of the claimed design.

1 Claim, 10 Drawing Sheets

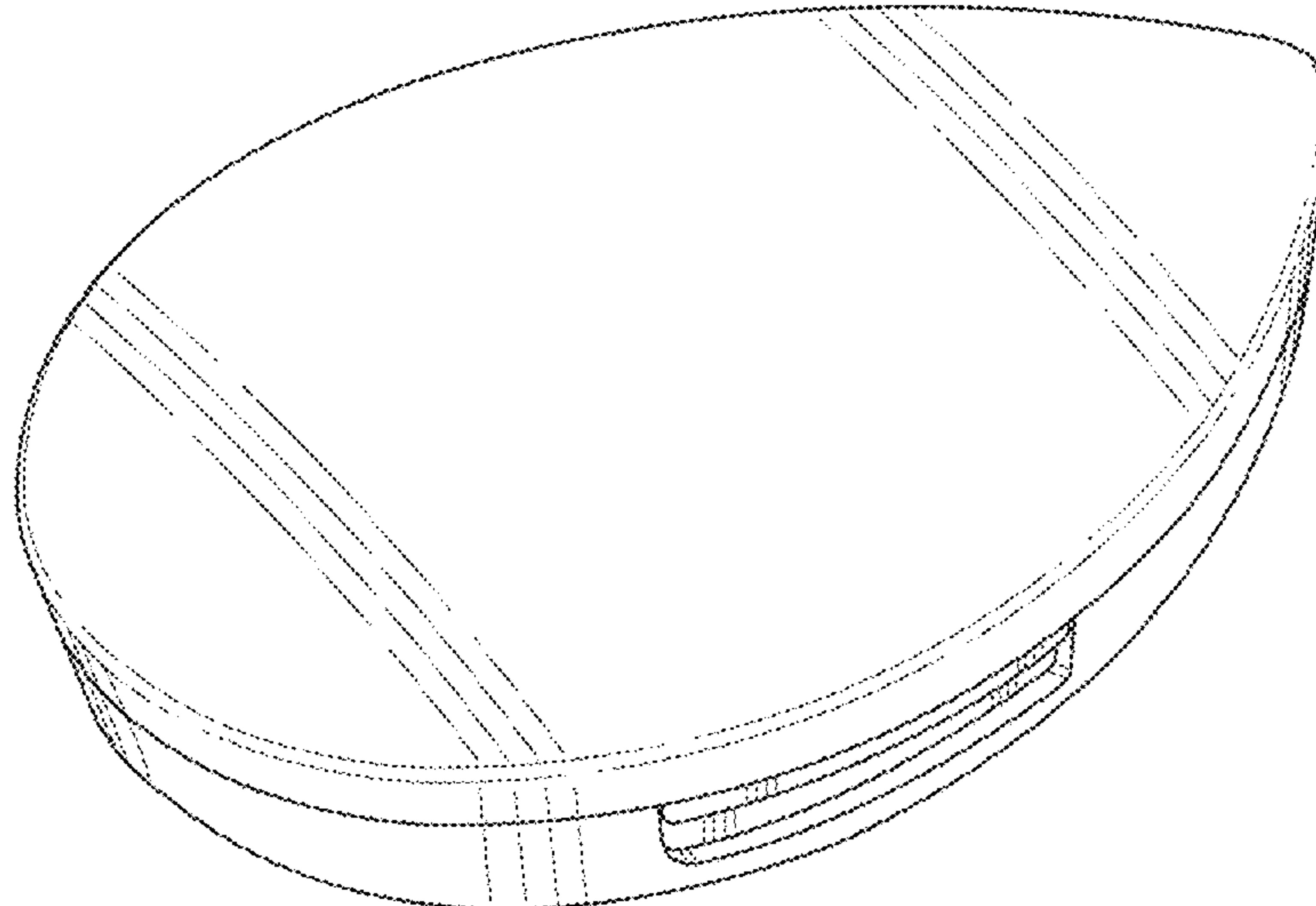

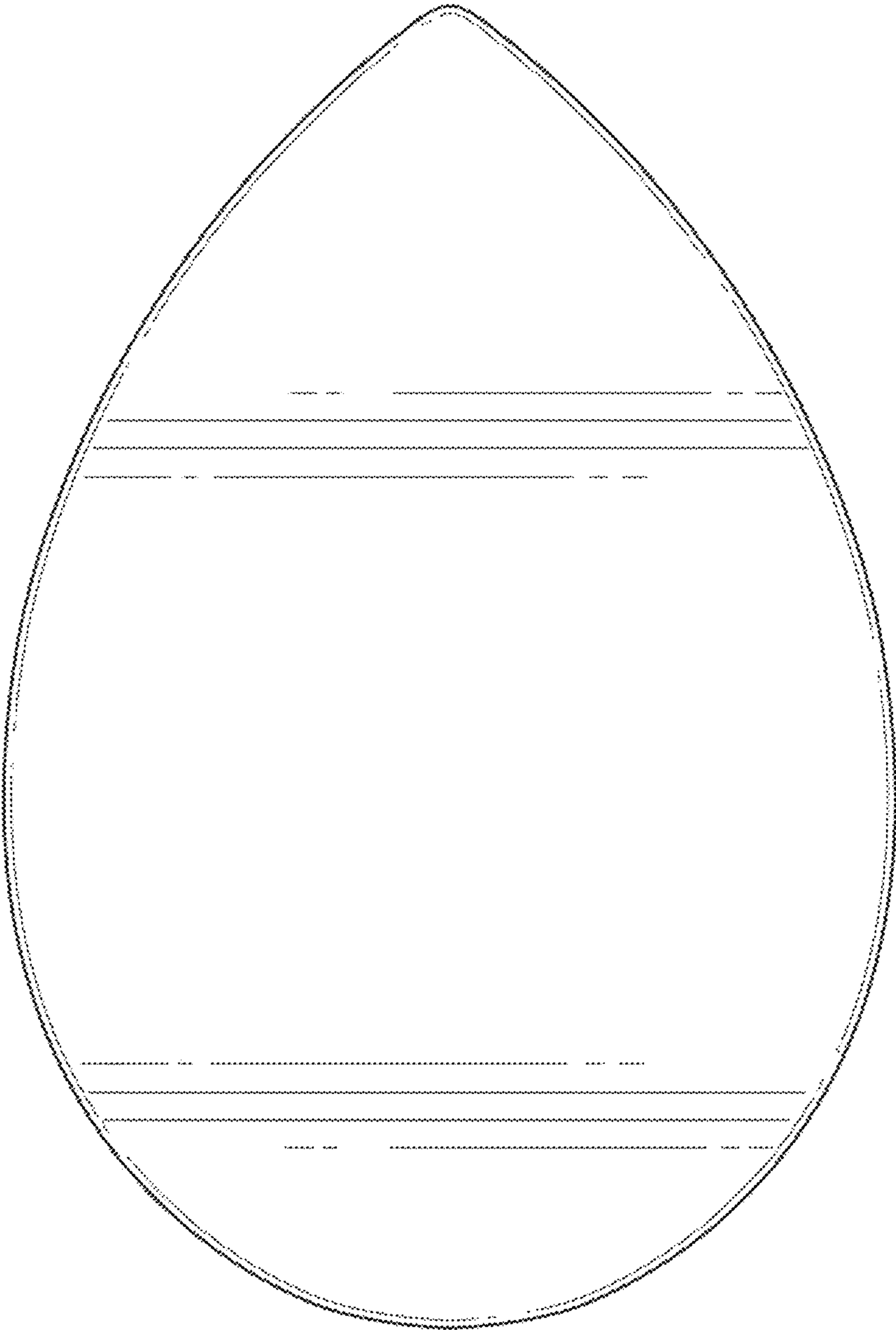

FIG. 1

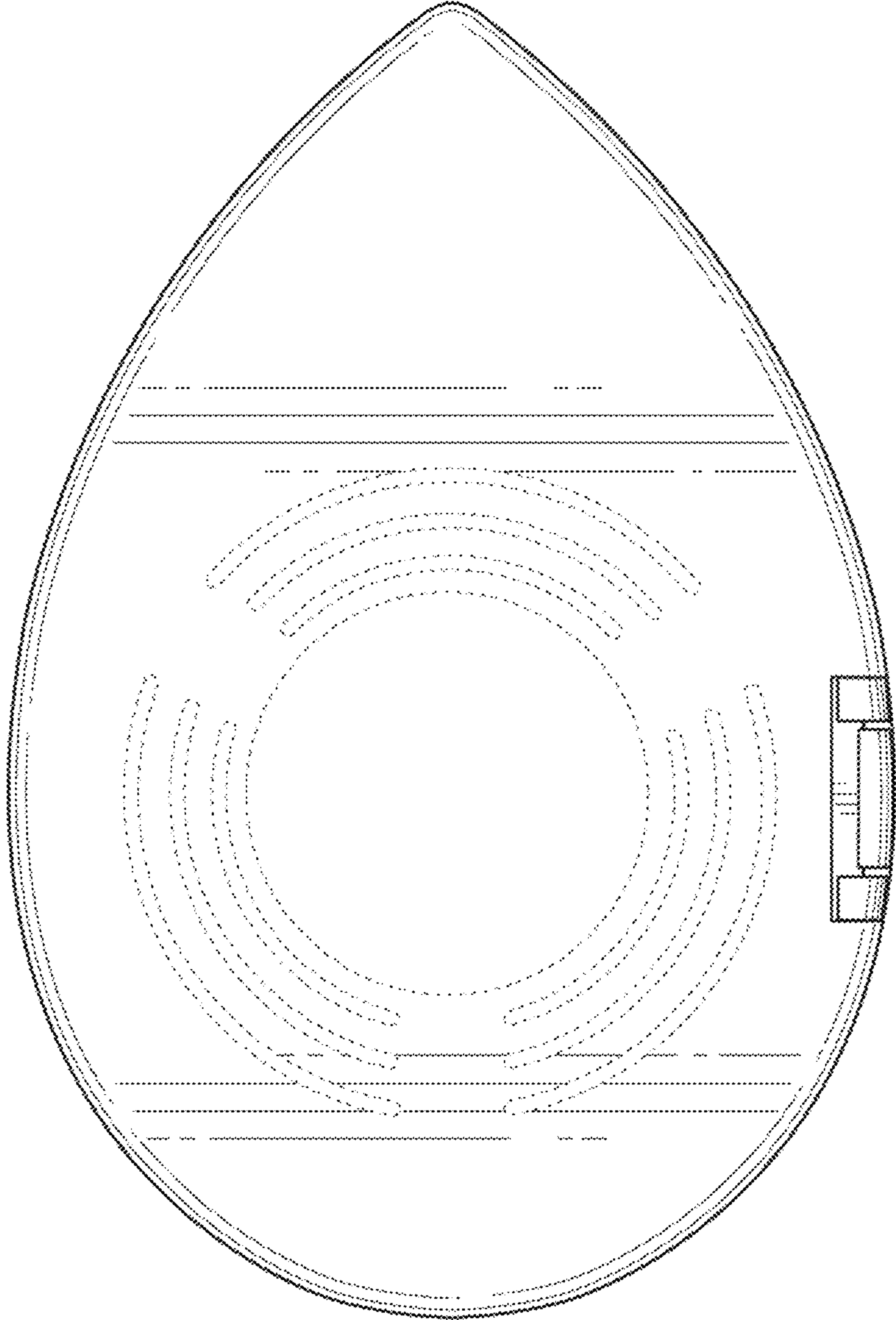

FIG. 2

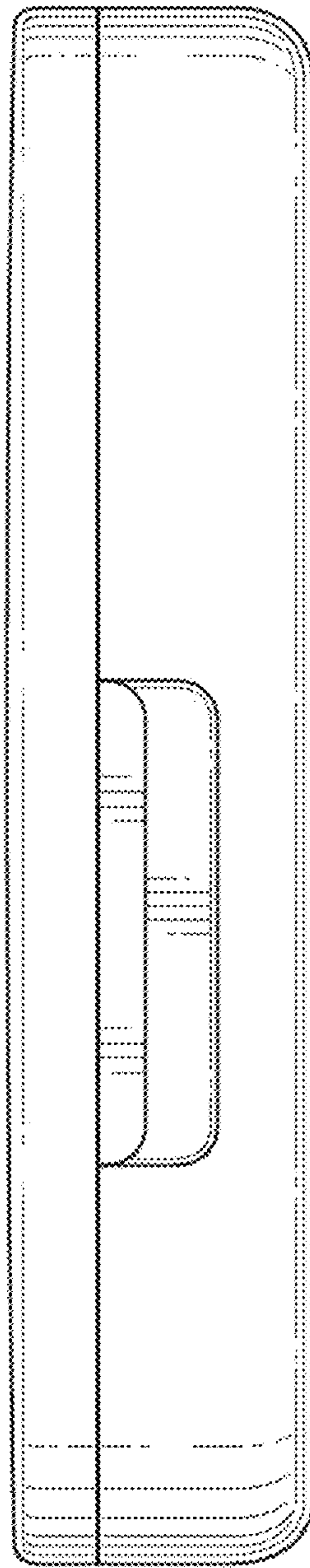

FIG. 3

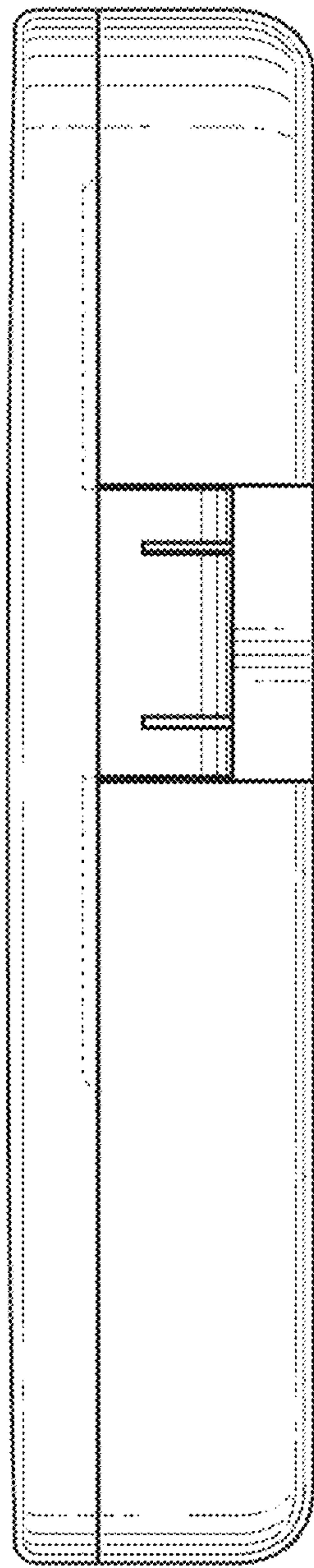

FIG. 4

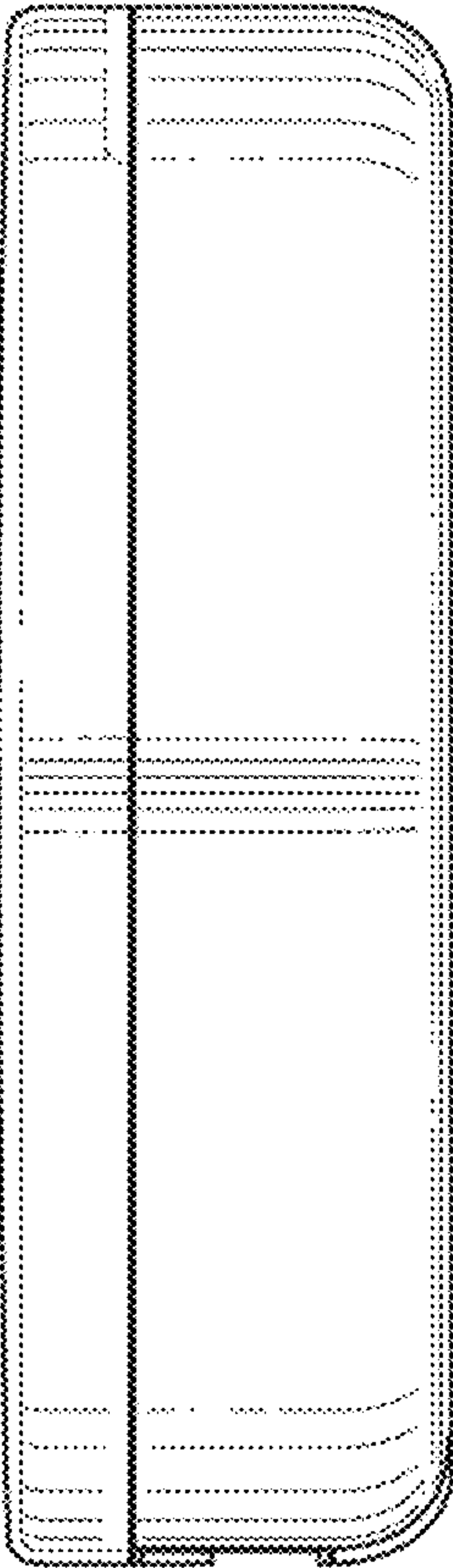

FIG. 5

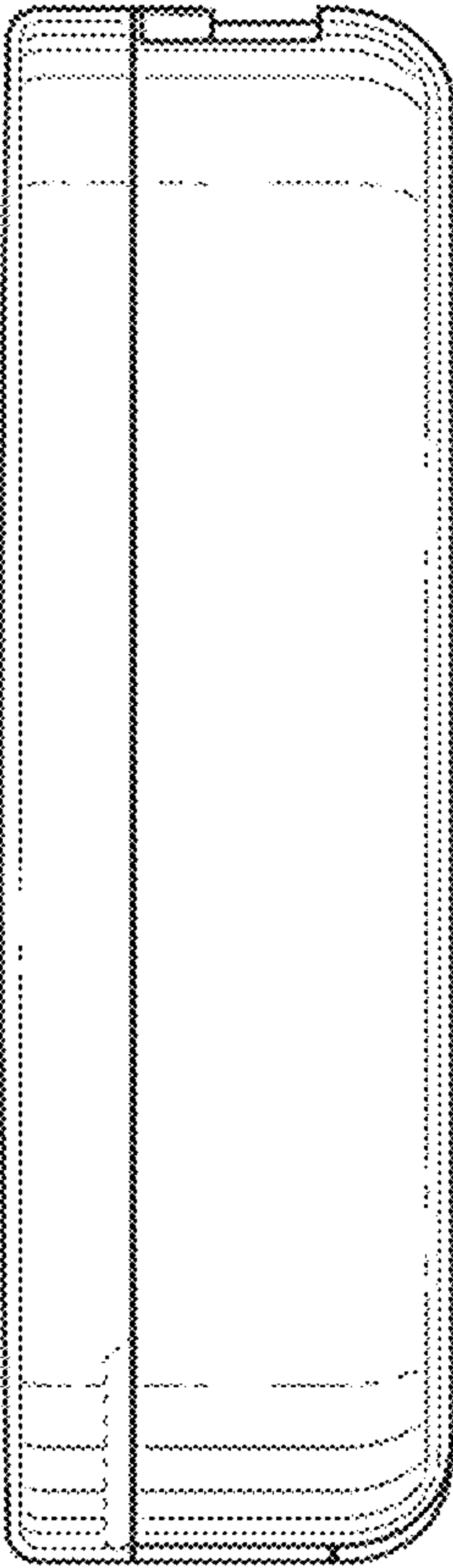

FIG. 6

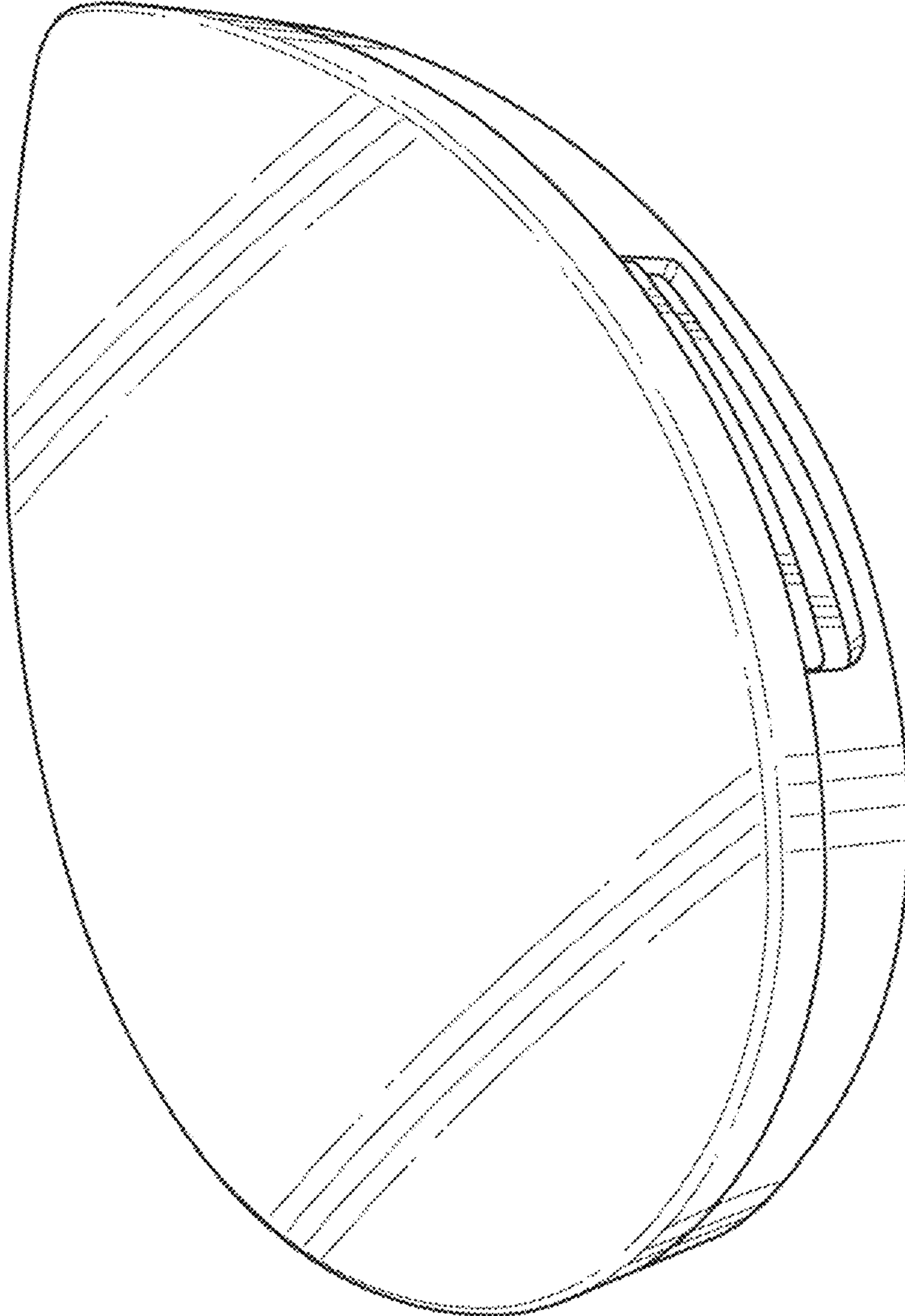

FIG. 7

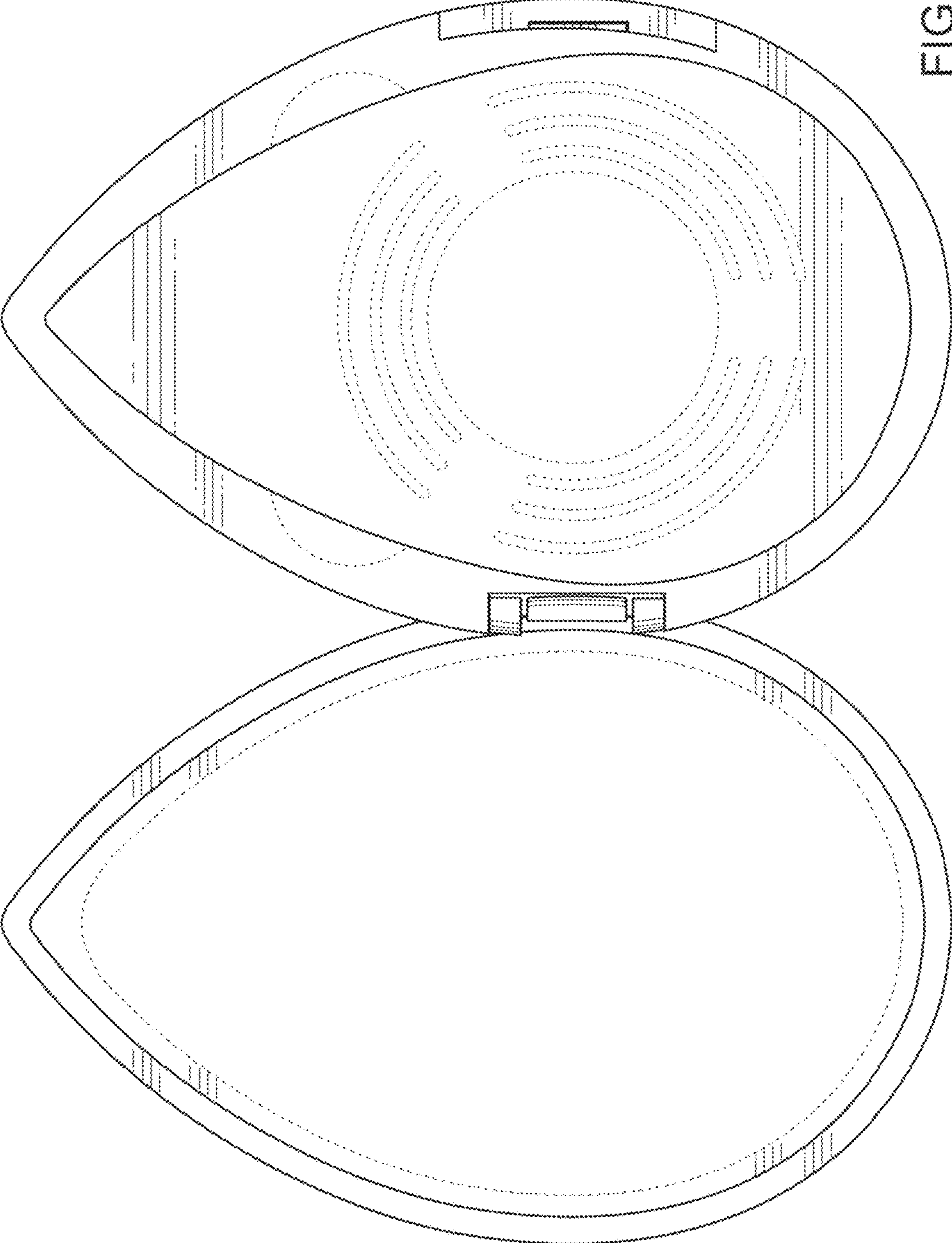

FIG. 8

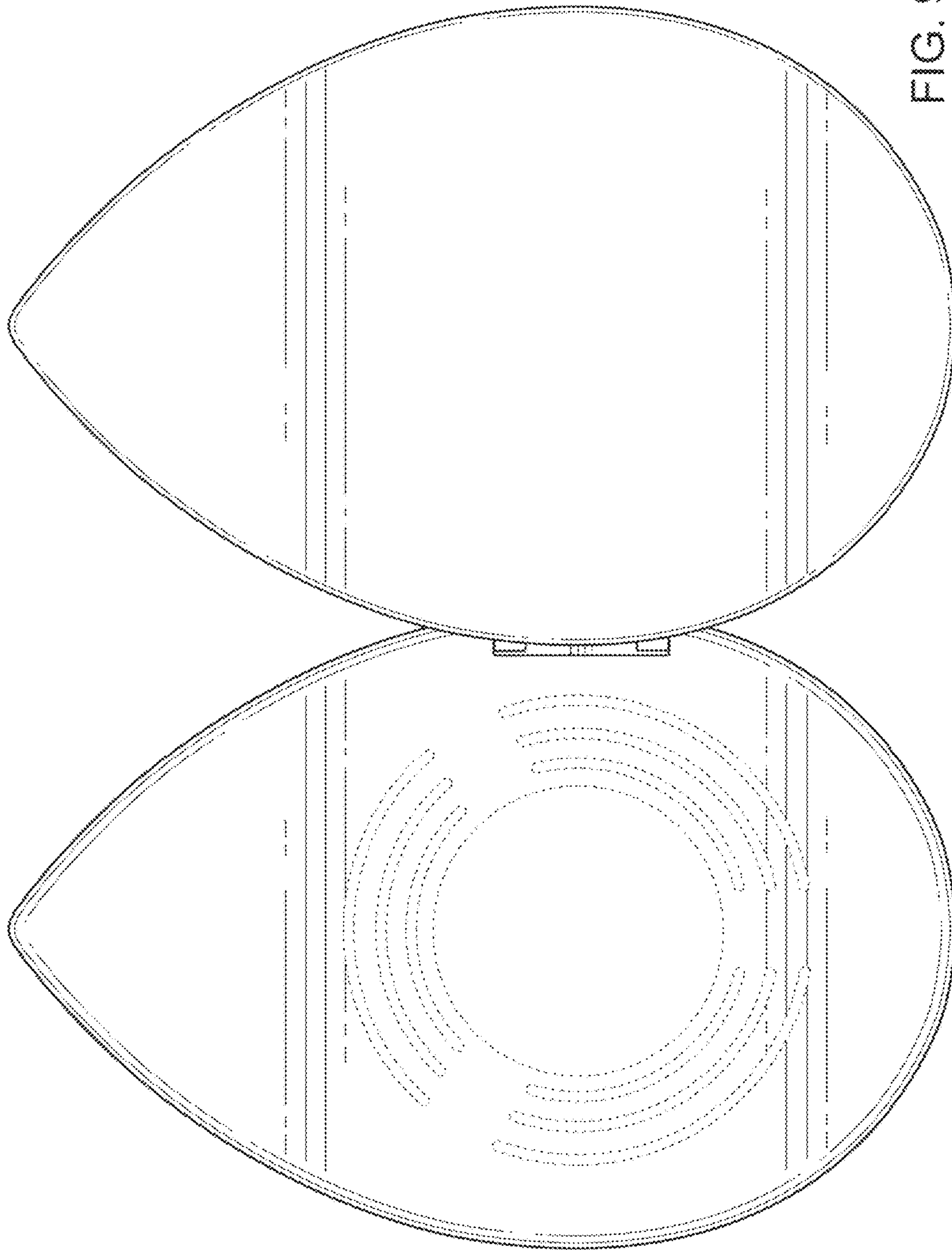

FIG. 9

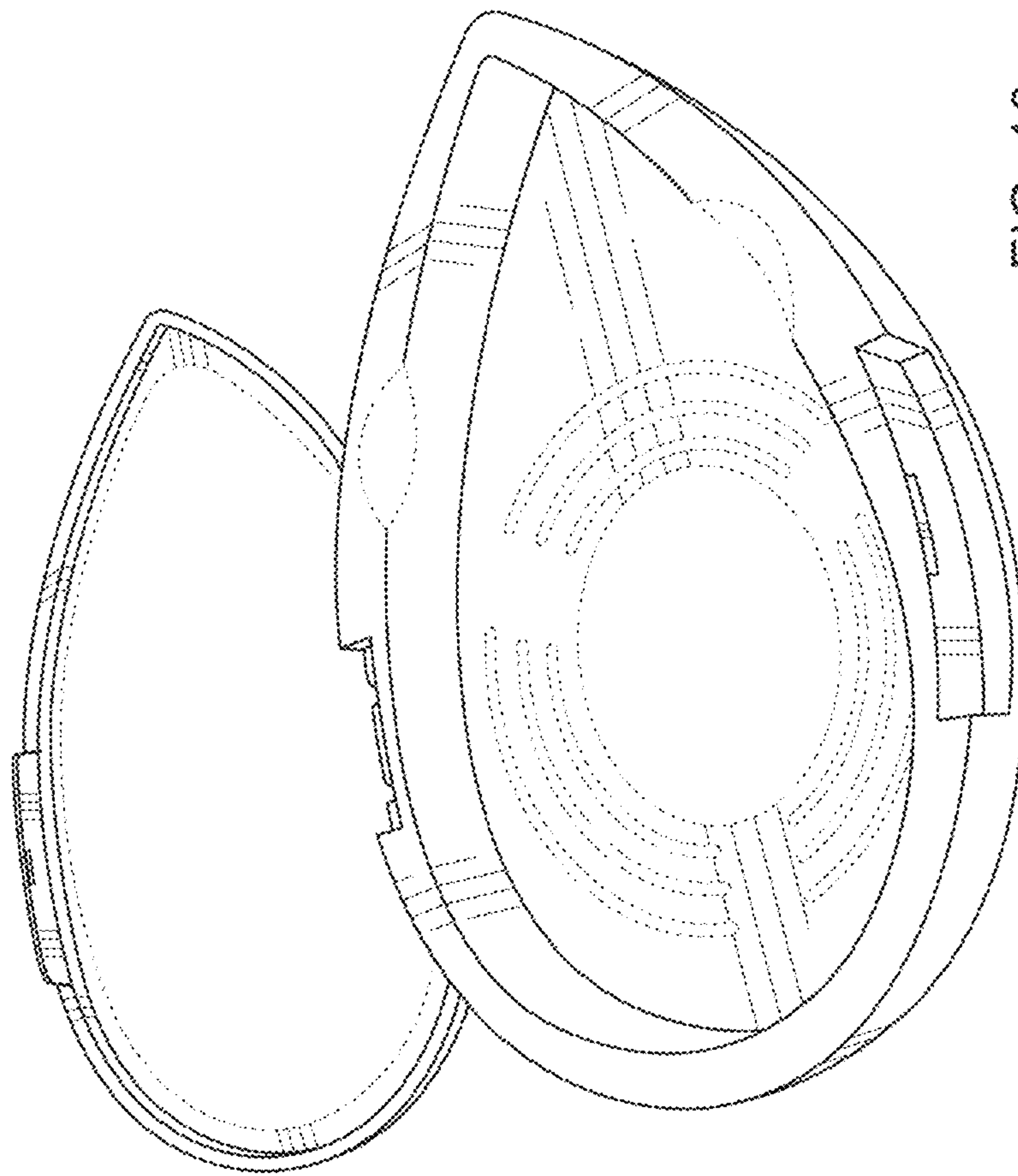

FIG. 10