



US00D800937S

(12) **United States Design Patent**
Li

(10) **Patent No.:** **US D800,937 S**

(45) **Date of Patent:** **** Oct. 24, 2017**

(54) **LAMP**

(71) Applicant: **Shenzhen Aukey E-Business Co., Ltd.**,
Shenzhen (CN)

(72) Inventor: **Yongzhu Li**, Shenzhen (CN)

(73) Assignee: **Shenzhen Aukey E-Business Co., Ltd.**,
Shenzhen (CN)

(**) Term: **15 Years**

(21) Appl. No.: **29/584,571**

(22) Filed: **Nov. 16, 2016**

(51) **LOC (10) Cl.** **26-03**

(52) **U.S. Cl.**
USPC **D26/63**

(58) **Field of Classification Search**
USPC D26/1, 24, 61, 63, 65, 85, 92
CPC F21V 21/14; F21V 15/01; F21V 14/02;
F21V 21/30; F21V 21/00; F21V 14/00;
F21S 8/00; F21S 8/003; F21S 8/043;
F21Y 2105/001

See application file for complete search history.

(56) **References Cited**

U.S. PATENT DOCUMENTS

D386,273 S * 11/1997 Yan D26/63
D601,288 S * 9/2009 Thomson D26/63

D604,883 S * 11/2009 Park D26/65
D628,331 S * 11/2010 Tang D26/63
D637,331 S * 5/2011 Lee D26/63
D654,199 S * 2/2012 Xie D26/63
D655,938 S * 3/2012 Kim D26/63
D739,976 S * 9/2015 Wu D26/63

* cited by examiner

Primary Examiner — Brian N Vinson

(74) *Attorney, Agent, or Firm* — JiangIP LLC; Yanling
Jiang

(57) **CLAIM**

The ornamental design for a lamp, as shown and described.

DESCRIPTION

FIG. 1 is a perspective view showing a lamp.
FIG. 2 is a front view of a lamp.
FIG. 3 is a rear view of a lamp.
FIG. 4 is a top view of a lamp.
FIG. 5 is a bottom view of a lamp.
FIG. 6 is a side view of a lamp; and,
FIG. 7 is a side view of a lamp.

1 Claim, 7 Drawing Sheets

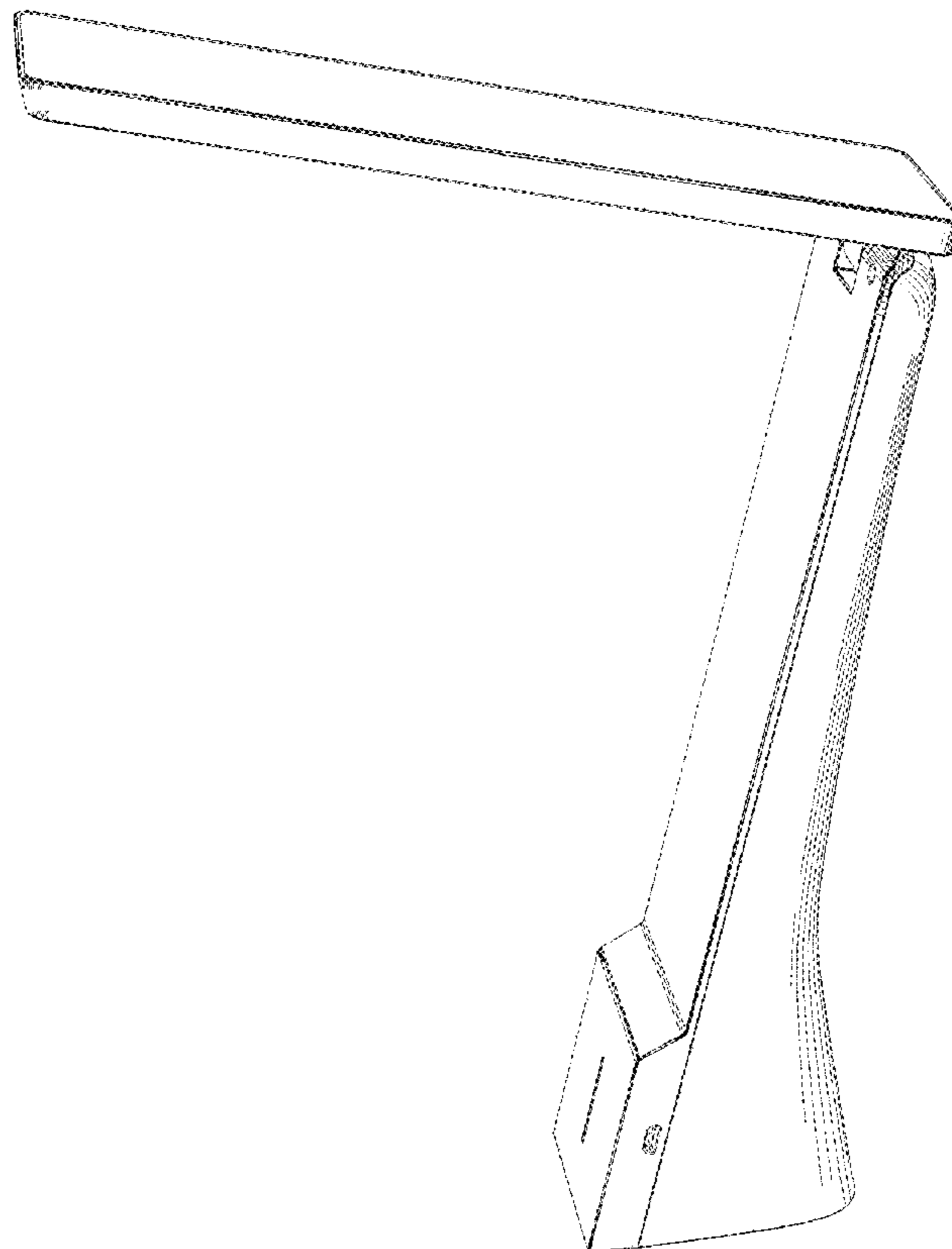

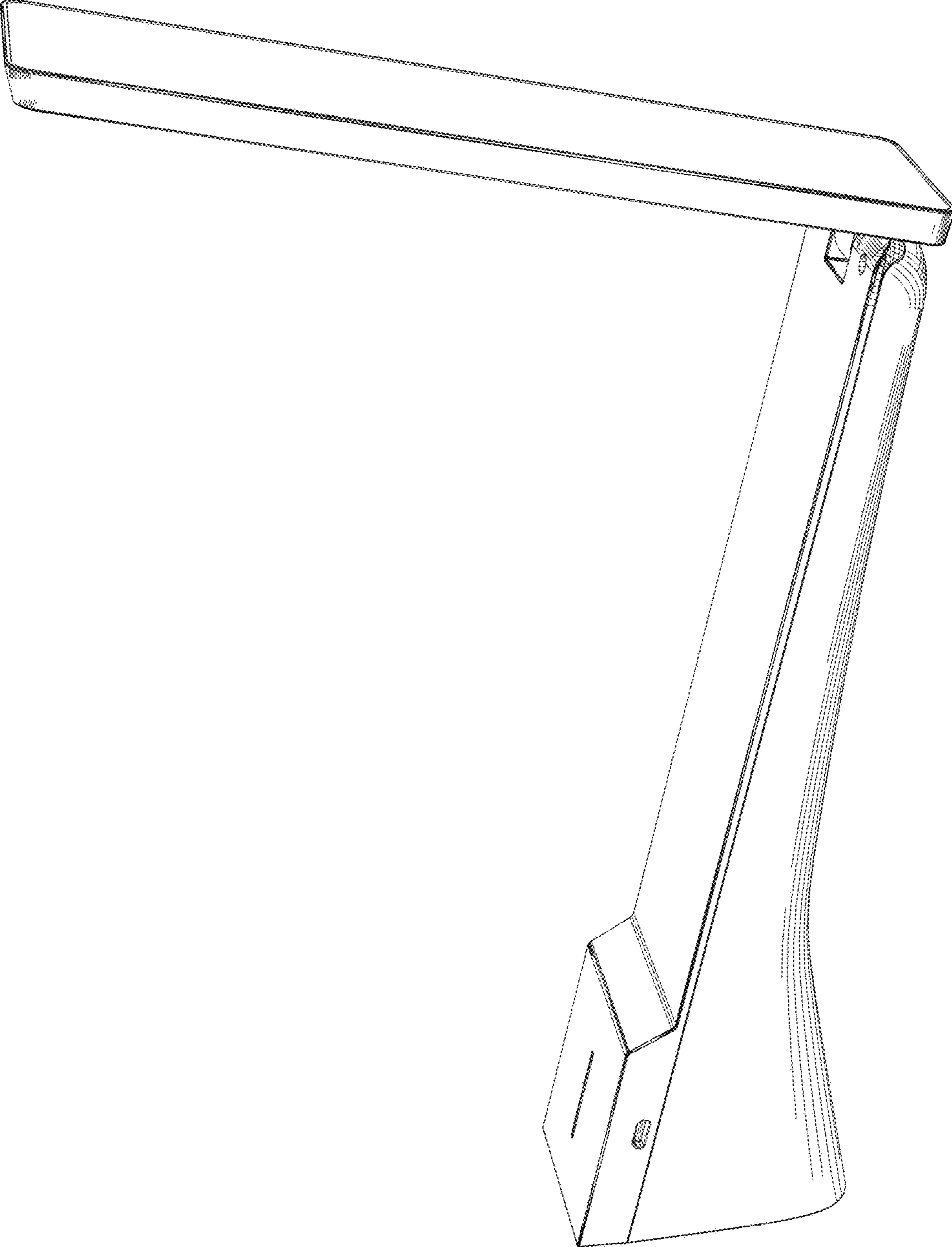

Fig. 1

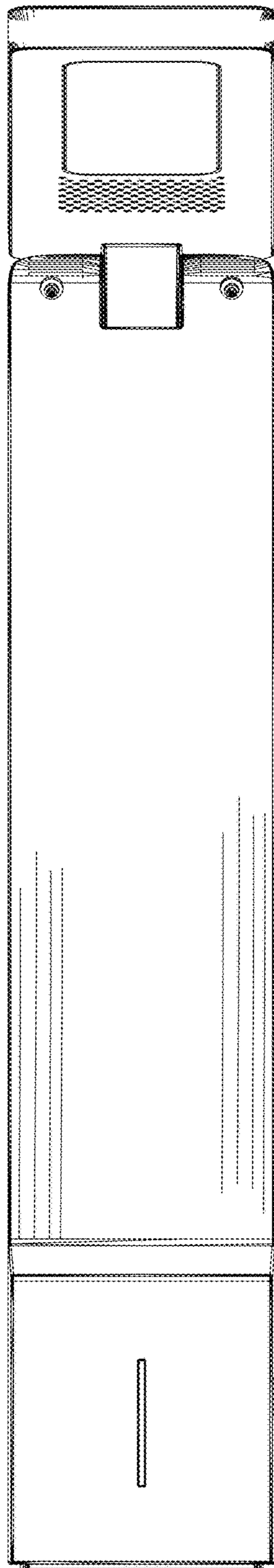

Fig. 2

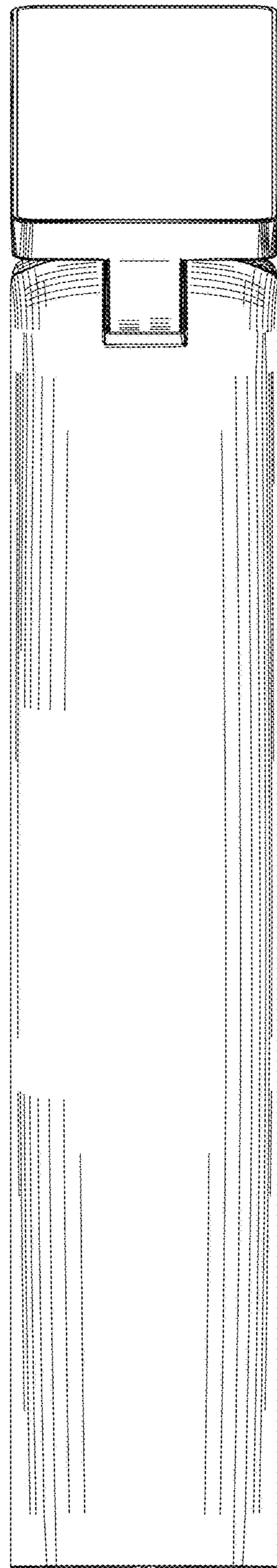

Fig. 3

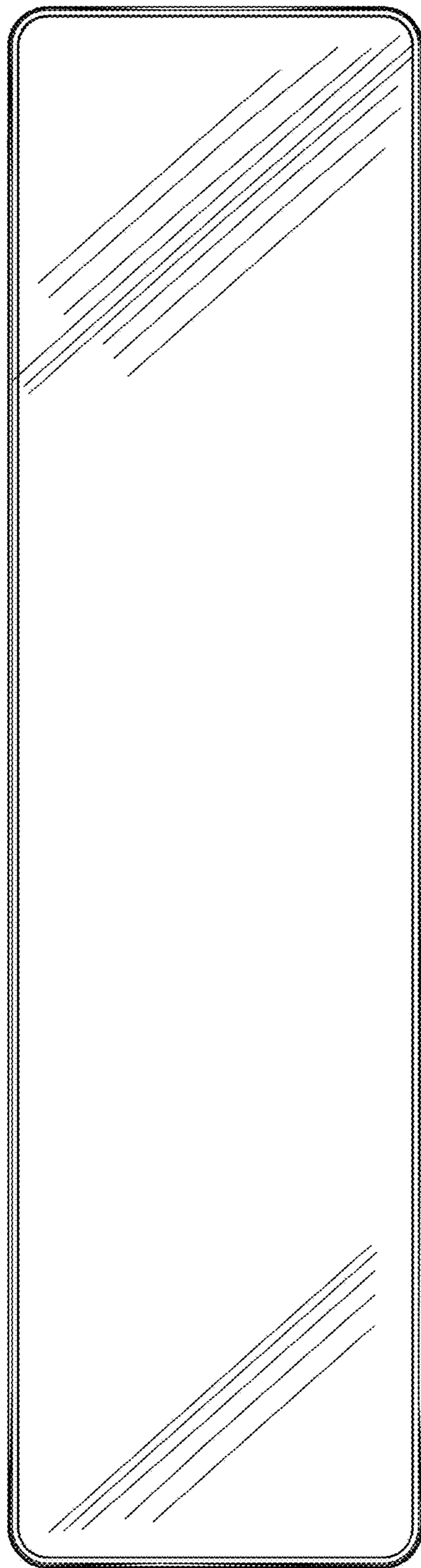

Fig. 4

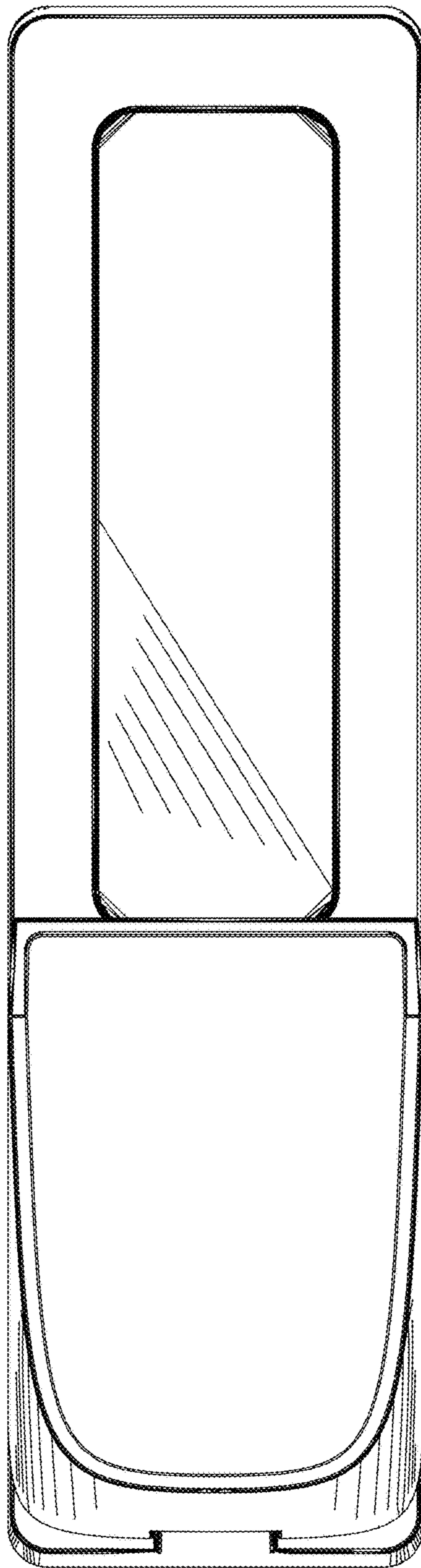

Fig. 5

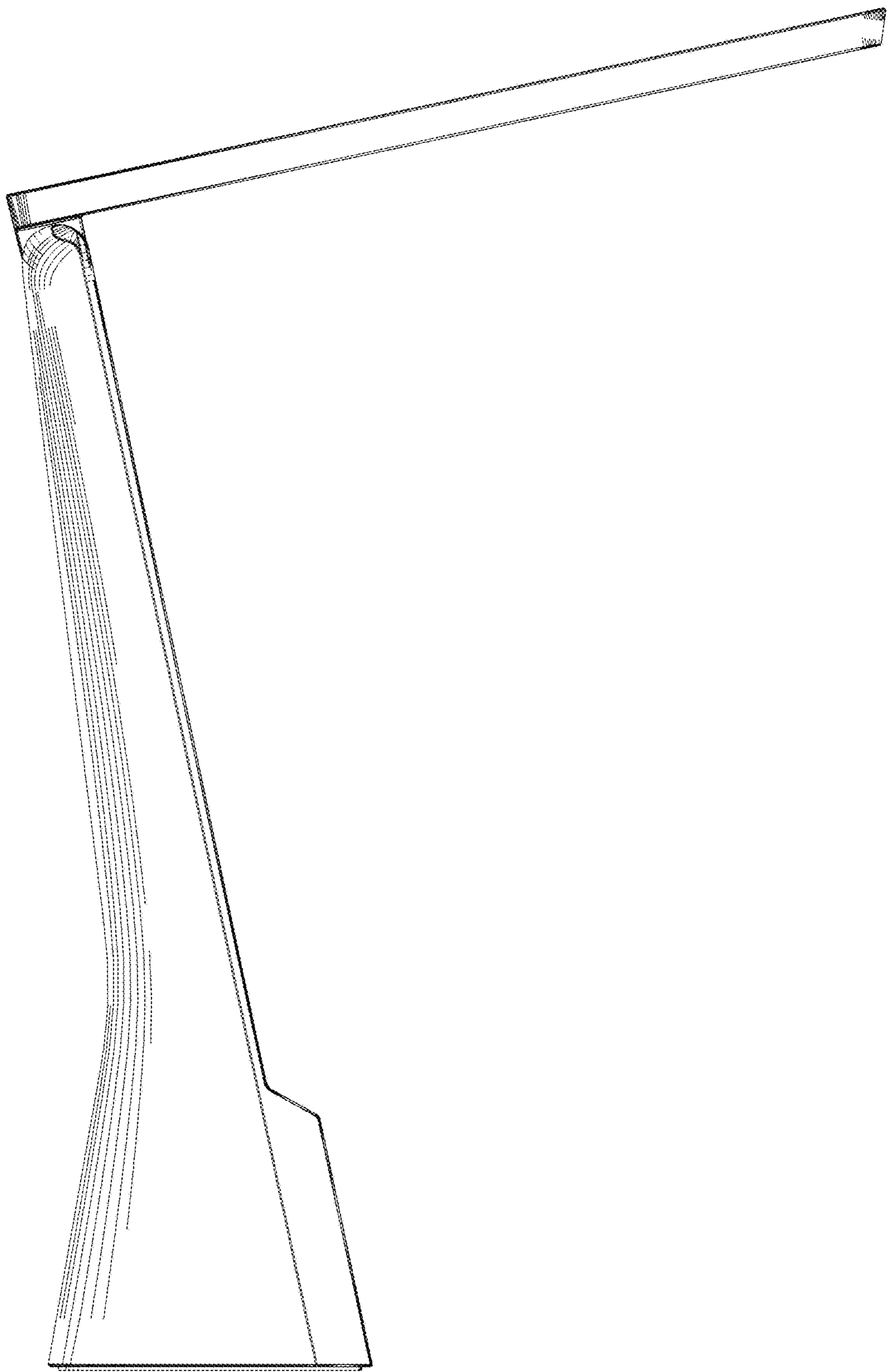

Fig. 6

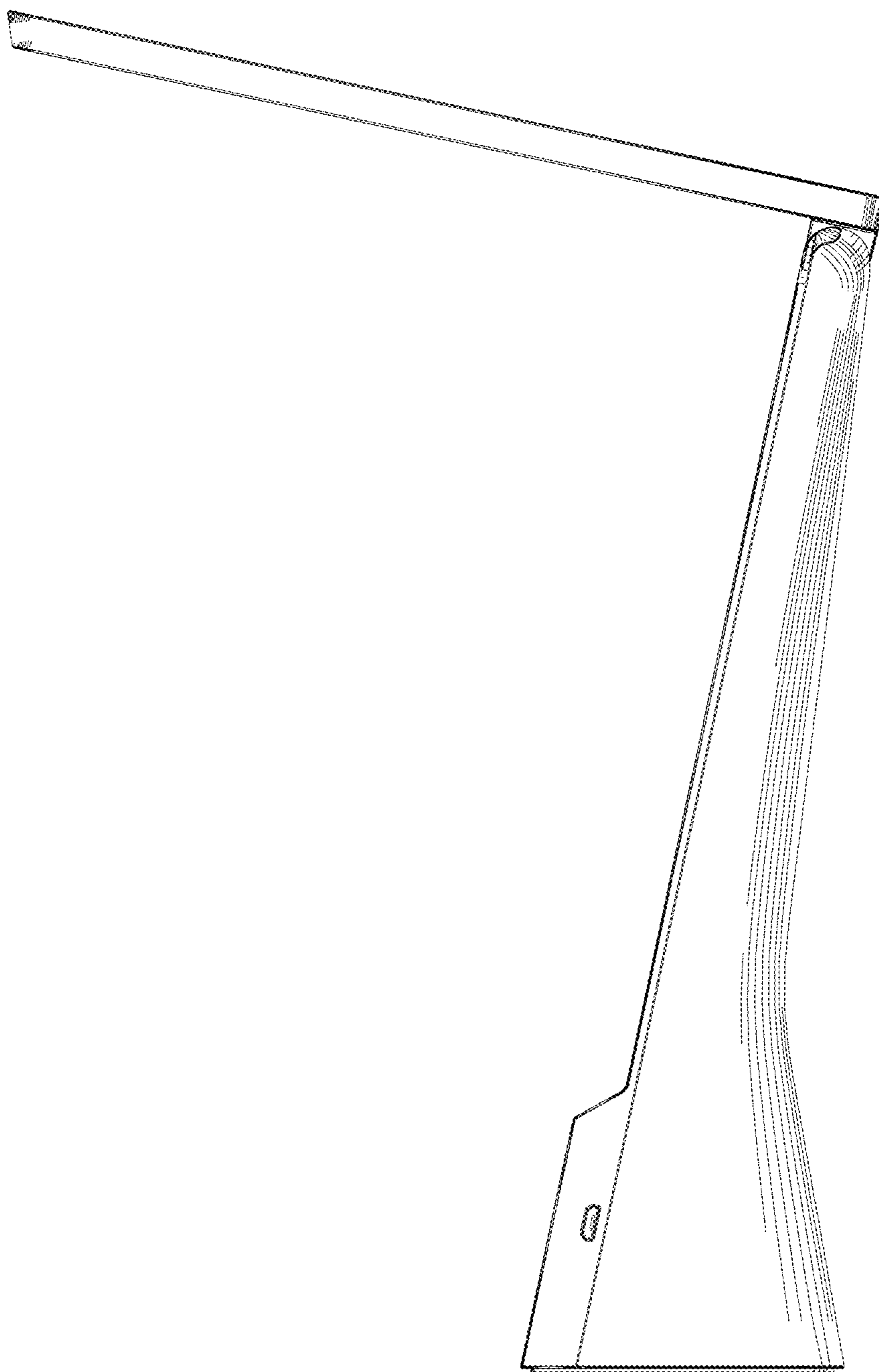

Fig. 7