



US00D800889S

(12) **United States Design Patent** (10) **Patent No.:** **US D800,889 S**
Hamada et al. (45) **Date of Patent:** **** Oct. 24, 2017**

(54) **PROPELLER FAN**

(56) **References Cited**

(71) Applicant: **MITSUBISHI ELECTRIC CORPORATION**, Tokyo (JP)
(72) Inventors: **Shingo Hamada**, Tokyo (JP); **Koji Sachimoto**, Tokyo (JP); **Yosuke Kikuchi**, Tokyo (JP); **Hajime Ikeda**, Tokyo (JP); **Takashi Kobayashi**, Tokyo (JP); **Seiji Hirakawa**, Tokyo (JP); **Hiroshi Yoshikawa**, Tokyo (JP); **Hidetomo Nakagawa**, Tokyo (JP); **Hiroaki Makino**, Tokyo (JP)

U.S. PATENT DOCUMENTS

| | | | |
|-------------------|---------|---------------|------------------------|
| D511,824 S * | 11/2005 | Chen | D23/370 |
| D645,134 S * | 9/2011 | Lee | D23/411 |
| D701,300 S | 3/2014 | Tanabe et al. | |
| D743,018 S | 11/2015 | Rasmussen | |
| D745,955 S | 12/2015 | Chen et al. | |
| D755,134 S | 5/2016 | Andre et al. | |
| 2003/0124001 A1 * | 7/2003 | Chen | F04D 25/066 417/356 |
| 2005/0074336 A1 | 4/2005 | Li et al. | |
| 2005/0186077 A1 * | 8/2005 | Lee | F04D 29/30 416/179 |

(73) Assignee: **Mitsubishi Electric Corporation**, Tokyo (JP)

(Continued)

Primary Examiner — Cynthia Underwood

(**) Term: **15 Years**

(74) *Attorney, Agent, or Firm* — Stuebaker & Brackett PC

(21) Appl. No.: **29/588,692**

(57) **CLAIM**

(22) Filed: **Dec. 22, 2016**

The ornamental design for a propeller fan, as shown and described.

Related U.S. Application Data

DESCRIPTION

(62) Division of application No. 29/543,720, filed on Oct. 27, 2015, now Pat. No. Des. 782,639.

(30) **Foreign Application Priority Data**

| | | | |
|---------------|------|-------|-------------|
| Jun. 24, 2015 | (JP) | | 2015-013870 |
| Jun. 24, 2015 | (JP) | | 2015-013871 |
| Jun. 24, 2015 | (JP) | | 2015-013873 |
| Jun. 24, 2015 | (JP) | | 2015-013874 |

FIG. 1. is a front perspective view of the front, right, and bottom sides of a propeller fan showing an initial embodiment of our new design;
FIG. 2. is a front view thereof;
FIG. 3. is a rear view thereof;
FIG. 4. is a left side view thereof;
FIG. 5. is a right side view thereof;
FIG. 6. is a top plan view thereof;
FIG. 7. is a bottom view thereof; and,
FIG. 8. is an enlarged view at a part 8 of FIG. 1.
The broken lines shown represent unclaimed subject matter of the propeller fan and form no part of the claimed design. The dash-dot lines represent the boundary between the claimed design and unclaimed design.

(51) **LOC (10) Cl.** **23-04**

(52) **U.S. Cl.**
USPC **D23/370**

(58) **Field of Classification Search**
USPC D23/370, 355, 314, 371; 415/121.1
CPC F04D 29/329; F04D 29/526; F04D 25/082;
F04D 29/325; F04D 29/703; F04D
29/547; B65D 90/36; F23L 17/02; F24F
13/1406; F24F 1/02
See application file for complete search history.

1 Claim, 6 Drawing Sheets

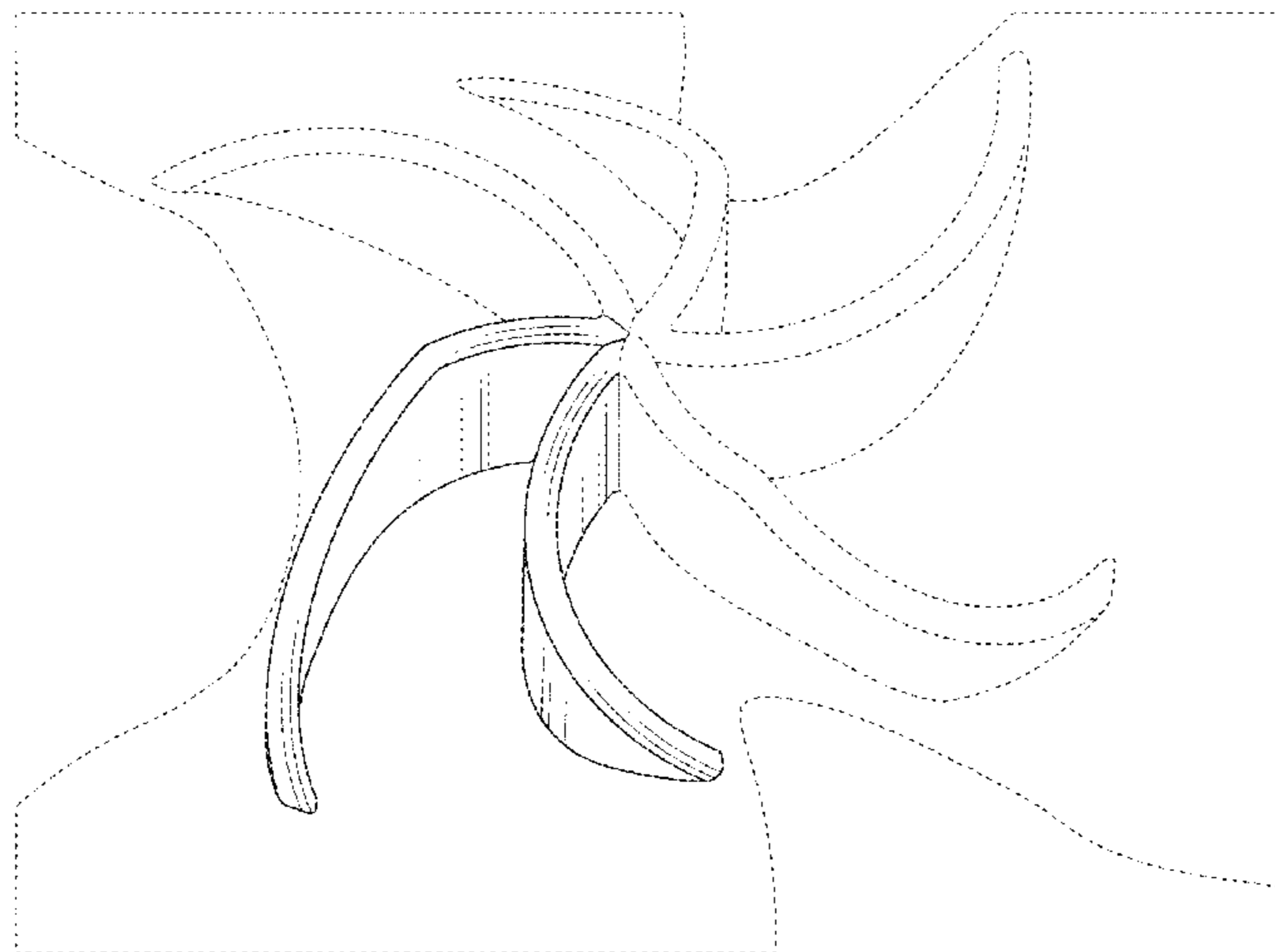

(56)

References Cited

U.S. PATENT DOCUMENTS

| | | | | |
|--------------|------|---------|-------------------|--------------------------|
| 2007/0166166 | A1 * | 7/2007 | Lee | F04D 29/384 416/189 |
| 2008/0044292 | A1 * | 2/2008 | Spaggiari | F04D 29/329 416/243 |
| 2011/0094460 | A1 * | 4/2011 | Hoskins | F04D 29/164 123/41.49 |
| 2011/0141693 | A1 | 6/2011 | Walsh et al. | |
| 2012/0244008 | A1 | 9/2012 | Chang et al. | |
| 2013/0028747 | A1 * | 1/2013 | Henner | F04D 29/384 416/242 |
| 2013/0120935 | A1 | 5/2013 | Huang | |
| 2013/0183140 | A1 | 7/2013 | Kappelman | |
| 2013/0259692 | A1 | 10/2013 | Chen | |
| 2013/0266439 | A1 * | 10/2013 | Rubak | F01D 1/04 415/208.1 |
| 2013/0287581 | A1 | 10/2013 | Aschermann et al. | |
| 2013/0315737 | A1 * | 11/2013 | Dygert | F04D 29/526 416/179 |
| 2014/0030104 | A1 | 1/2014 | Lee et al. | |
| 2014/0093405 | A1 | 4/2014 | Chang et al. | |
| 2014/0133082 | A1 | 5/2014 | Xu et al. | |
| 2014/0147282 | A1 | 5/2014 | Hu et al. | |
| 2015/0159672 | A1 | 6/2015 | Lin et al. | |

* cited by examiner

Fig. 1

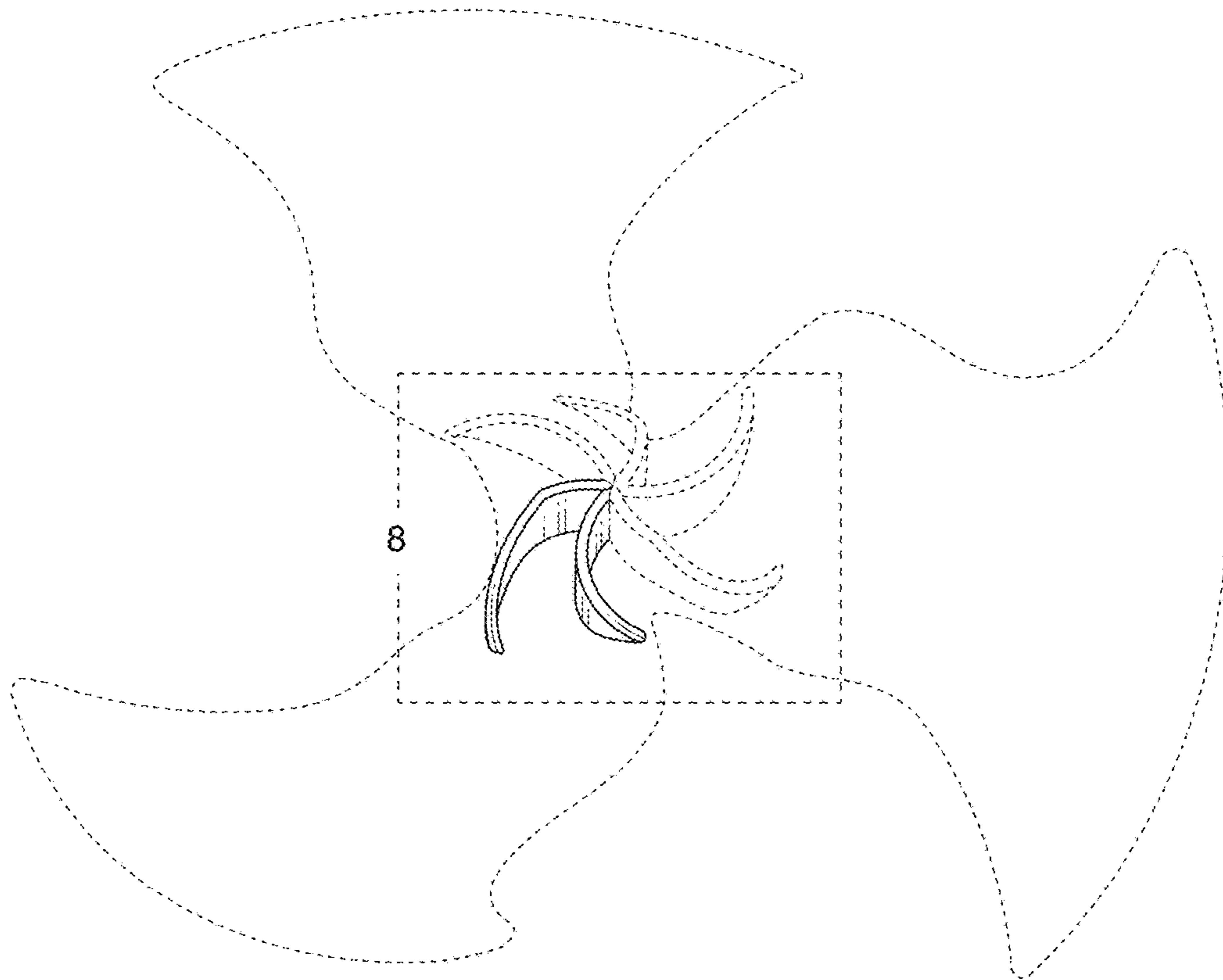

Fig. 2



Fig. 3

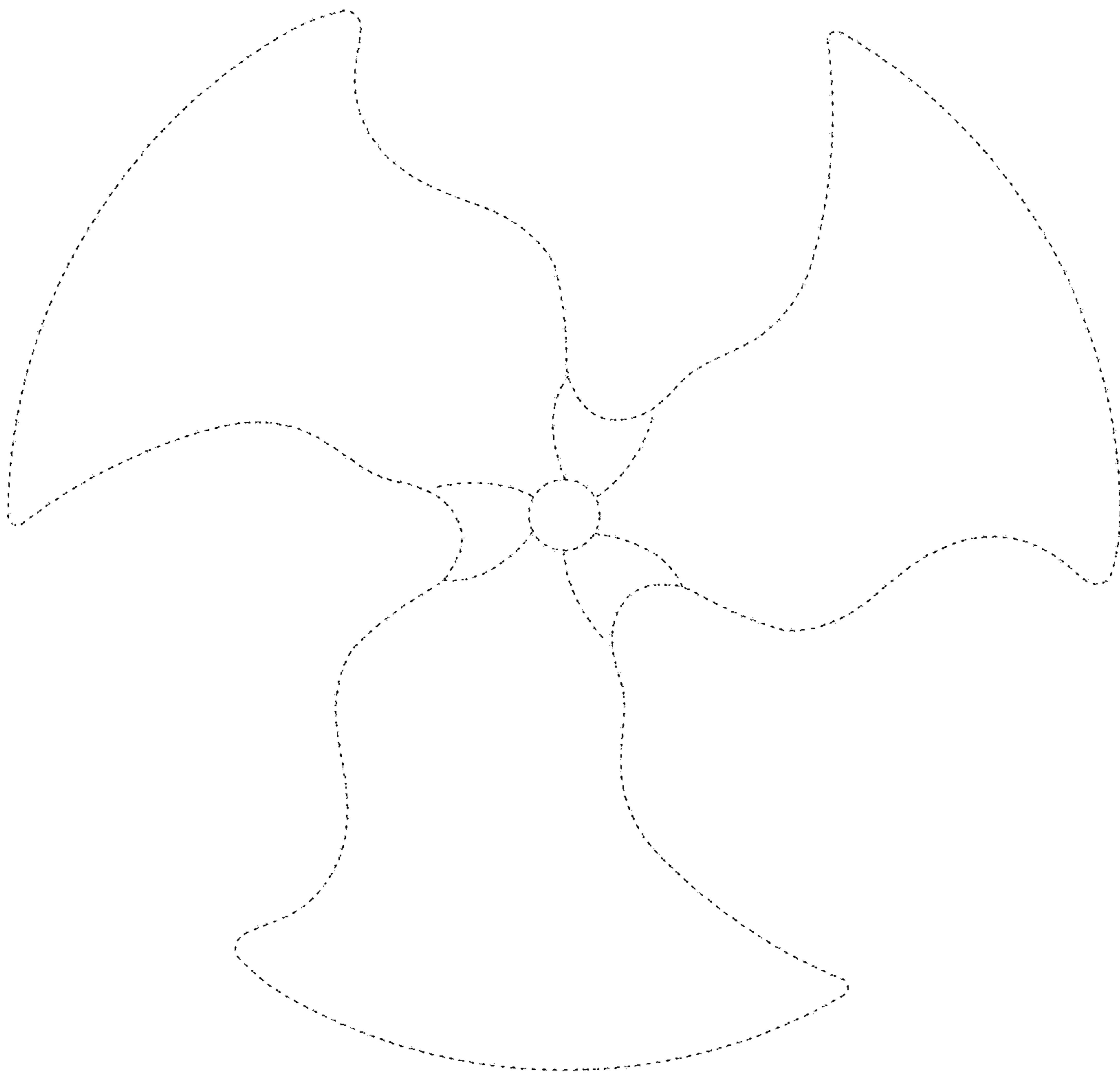

Fig. 4

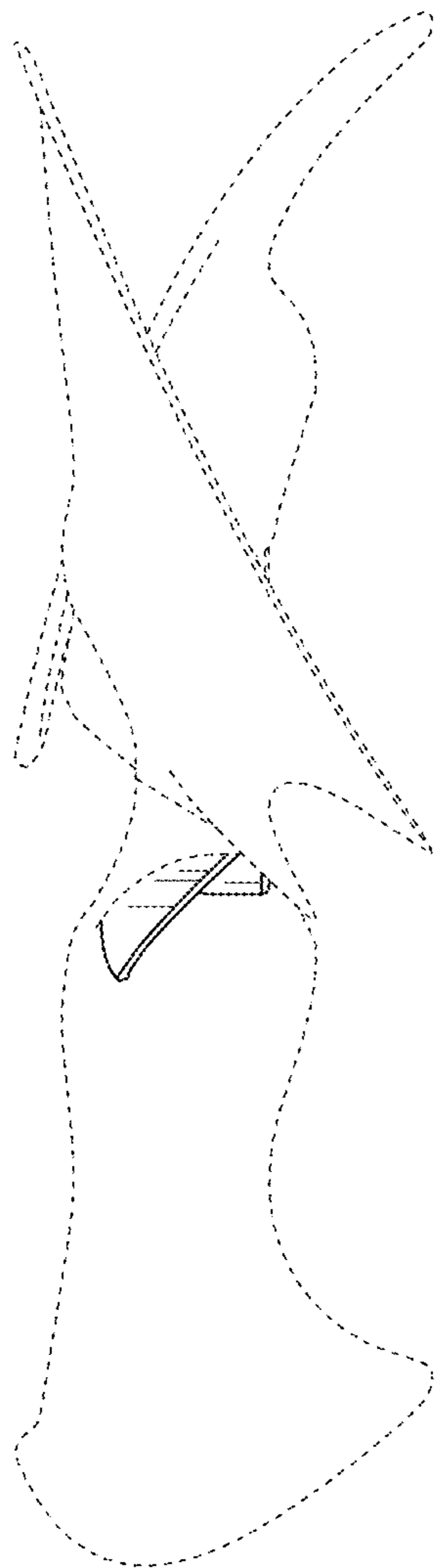

Fig. 5

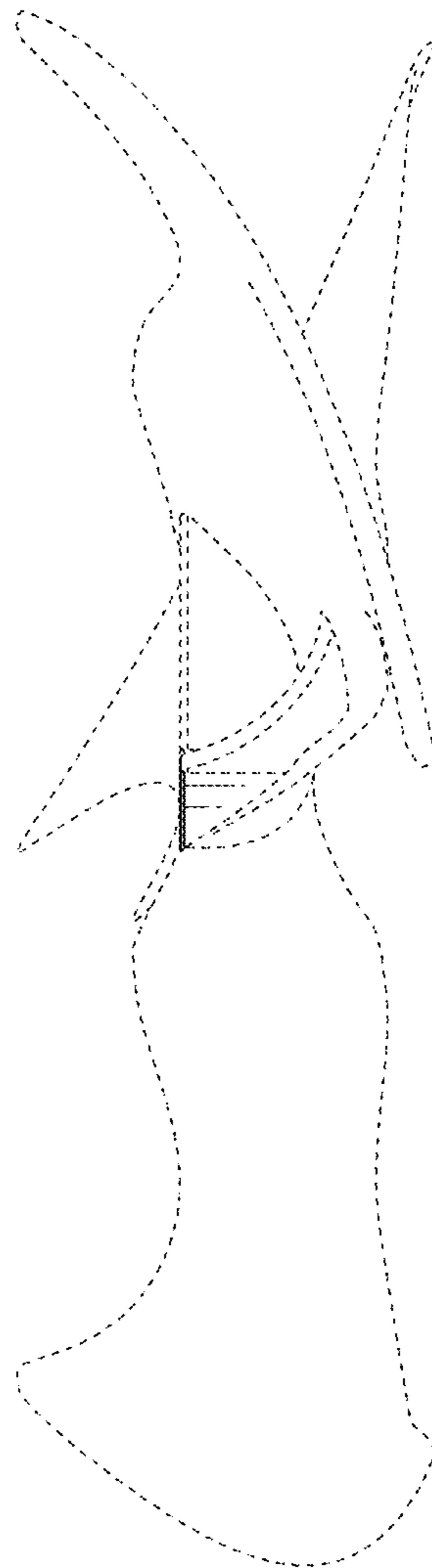

Fig. 6

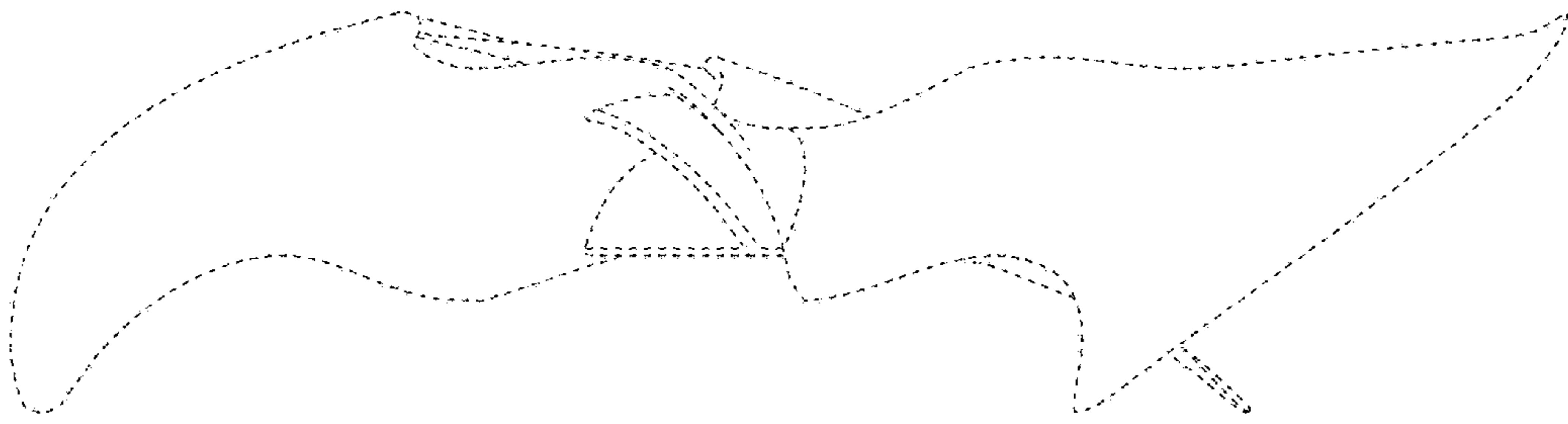

Fig. 7

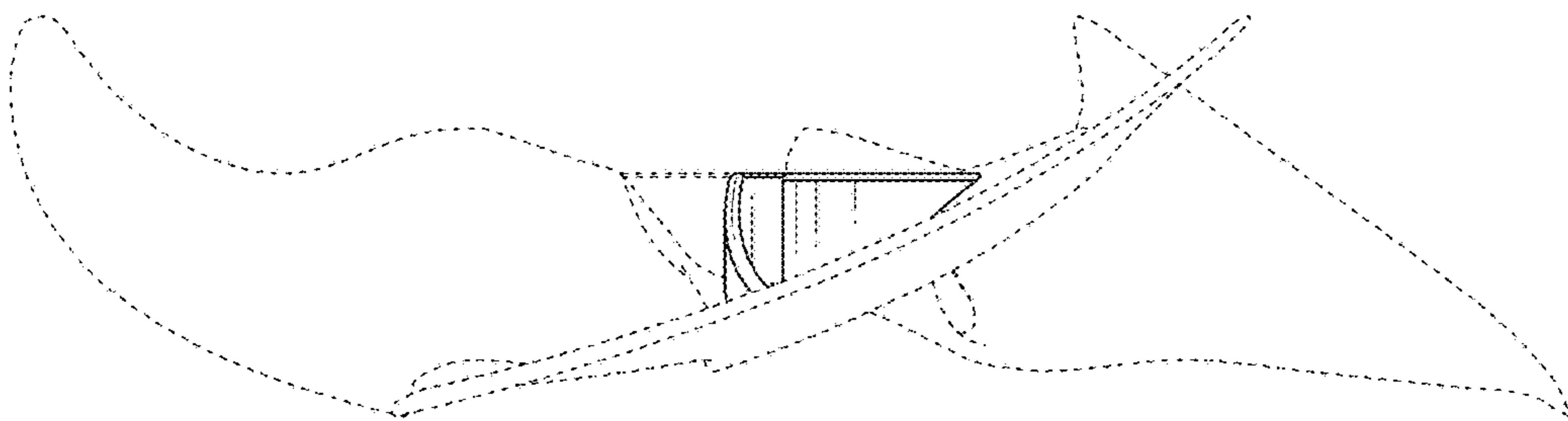

Fig. 8

