



US00D800888S

(12) **United States Design Patent**  
**Kincaid**

(10) **Patent No.:** **US D800,888 S**

(45) **Date of Patent:** **\*\* Oct. 24, 2017**

- (54) **AIR FRESHENER CARD**
- (71) Applicant: **Colin John Kincaid**, Crandon, WI (US)
- (72) Inventor: **Colin John Kincaid**, Crandon, WI (US)
- (\*\*) Term: **15 Years**
- (21) Appl. No.: **29/593,365**
- (22) Filed: **Feb. 8, 2017**

D705,920 S *	5/2014	Young	.....	D23/367
D710,944 S *	8/2014	Bengyak	.....	D20/30
D726,296 S *	4/2015	Talbot	.....	D23/366
D752,197 S *	3/2016	Stroikov	.....	D23/366
D787,658 S *	5/2017	Civale	.....	D22/122
D788,901 S *	6/2017	Warberg Block	.....	D23/368
2008/0179424 A1 *	7/2008	Cheung	.....	A61L 9/03 239/60

\* cited by examiner

*Primary Examiner* — Rhea Shields

(74) *Attorney, Agent, or Firm* — Dunlap Bennett & Ludwig PLLC

**Related U.S. Application Data**

- (63) Continuation-in-part of application No. 29/508,599, filed on Nov. 7, 2014, now abandoned.
- (51) **LOC (10) Cl.** ..... **28-99**
- (52) **U.S. Cl.**  
USPC ..... **D23/367**
- (58) **Field of Classification Search**  
USPC ..... D23/367, 366, 368; D11/101; D20/22, D20/30; D22/122; 239/60  
CPC ..... A61L 9/03  
See application file for complete search history.

(57) **CLAIM**

The ornamental design for an air freshener card, as shown and described.

**DESCRIPTION**

FIG. 1 is a top front elevation view of the air freshener card showing my new design;  
 FIG. 2 is a rear elevation view thereof;  
 FIG. 3 is a top plan view thereof;  
 FIG. 4 is a bottom plan view thereof;  
 FIG. 5 is a right side elevation view thereof;  
 FIG. 6 is a left side elevation view thereof; and,  
 FIG. 7 is a front perspective view thereof.

The broken lines shown in the drawings illustrate portions of the air freshener card that form no part of the claimed design. The dash-dot-dash lines in FIG. 2, which define the bounds of the claimed design, form no part thereof.

(56) **References Cited**

**U.S. PATENT DOCUMENTS**

D246,961 S *	1/1978	Buchanan	.....	D11/101
D287,049 S *	12/1986	Torres	.....	D23/367
D372,306 S *	7/1996	Smith	.....	D23/366
D398,391 S *	9/1998	Kutchko	.....	D20/22
D426,294 S *	6/2000	Trudeau	.....	D23/366
D429,325 S *	8/2000	Macaree	.....	D20/30
D616,974 S *	6/2010	Hakim	.....	D23/367
D688,782 S *	8/2013	Elhalwani	.....	D23/366

**1 Claim, 4 Drawing Sheets**

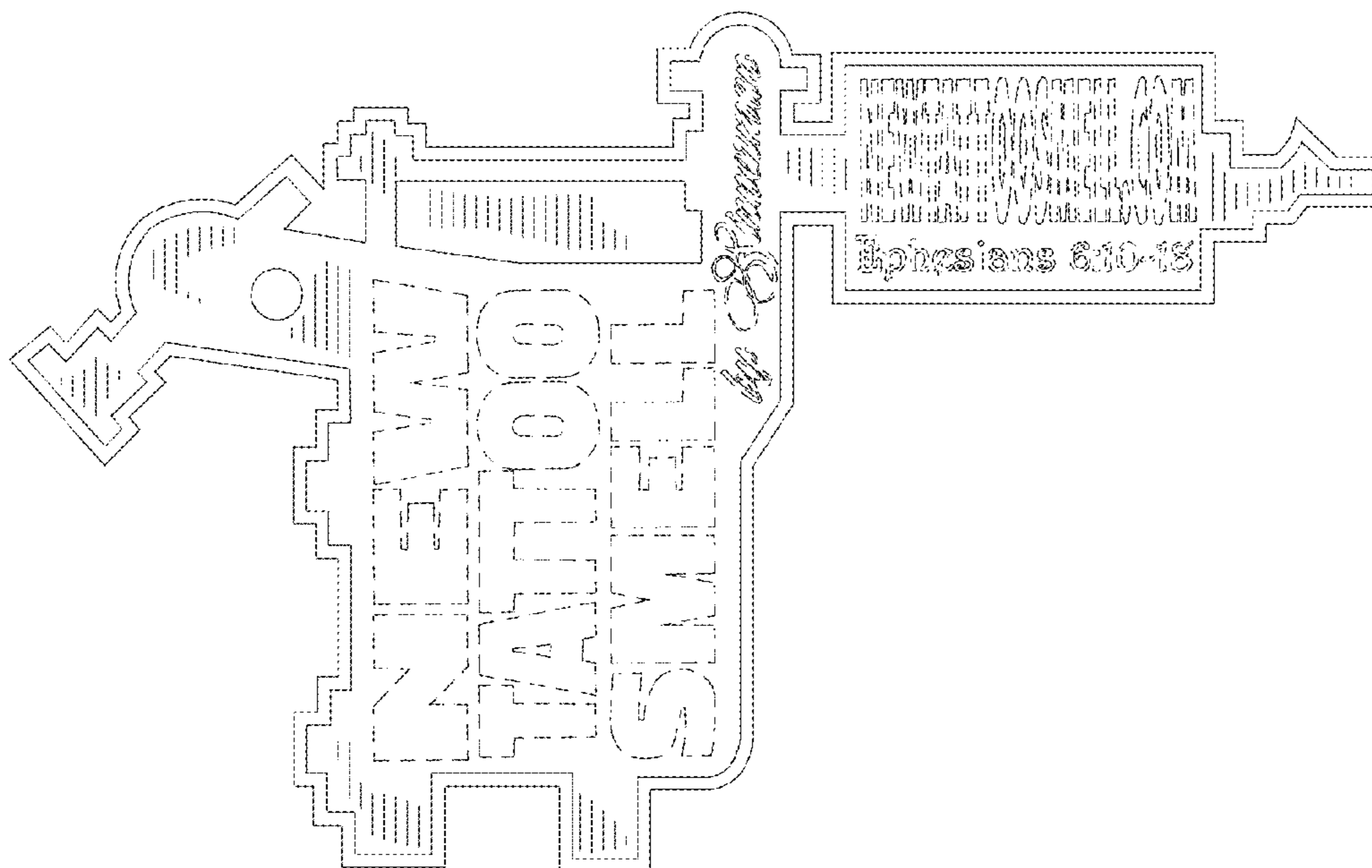

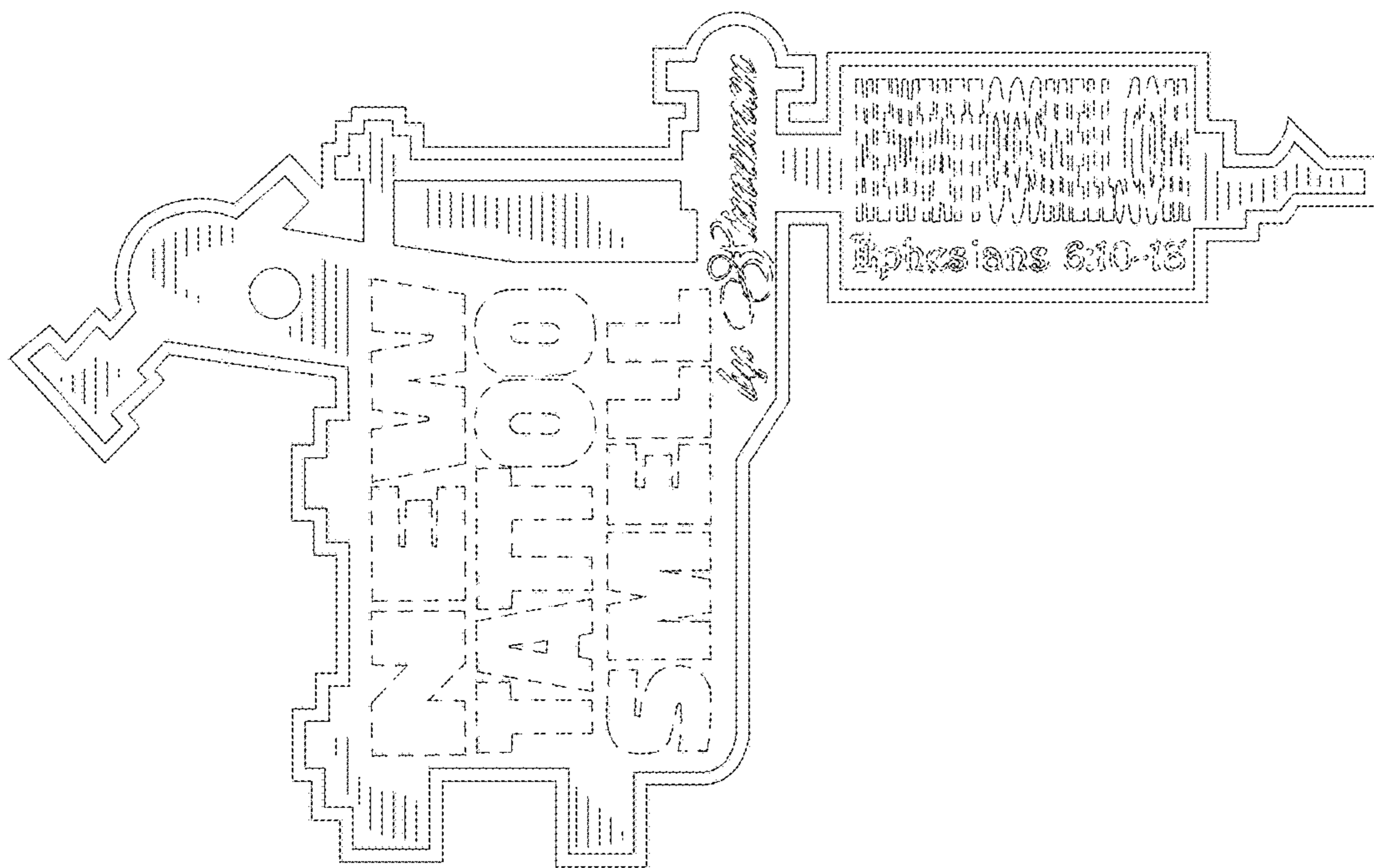

FIG. 1

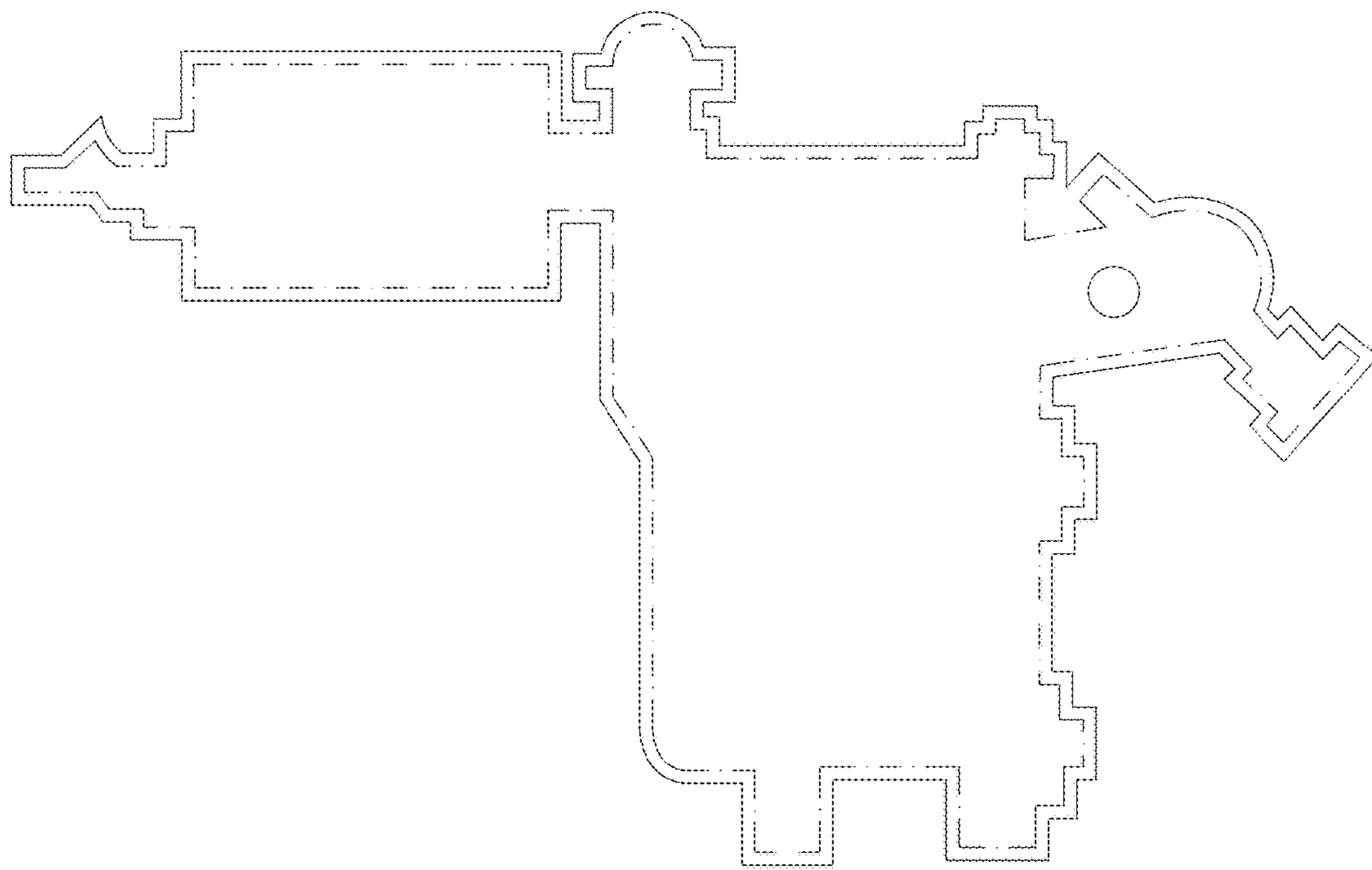

FIG. 2

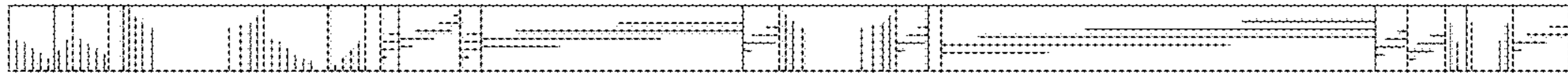

FIG. 3

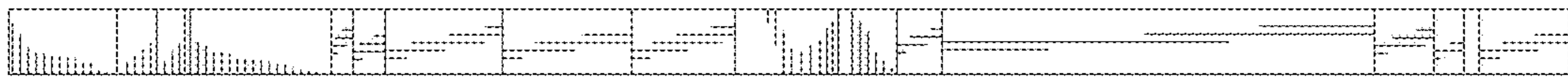

FIG. 4

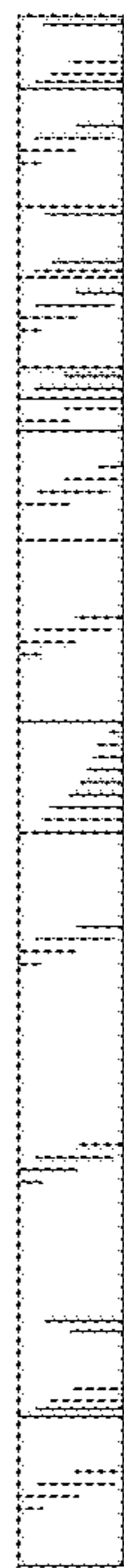

FIG. 5

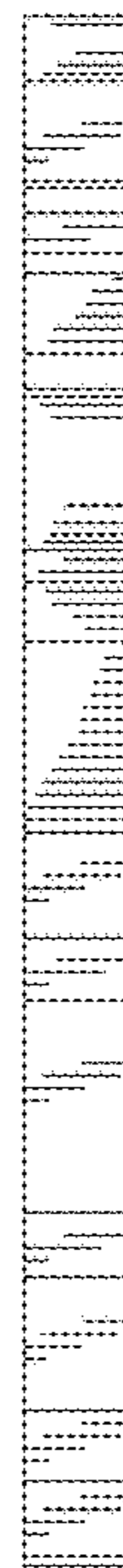

FIG. 6

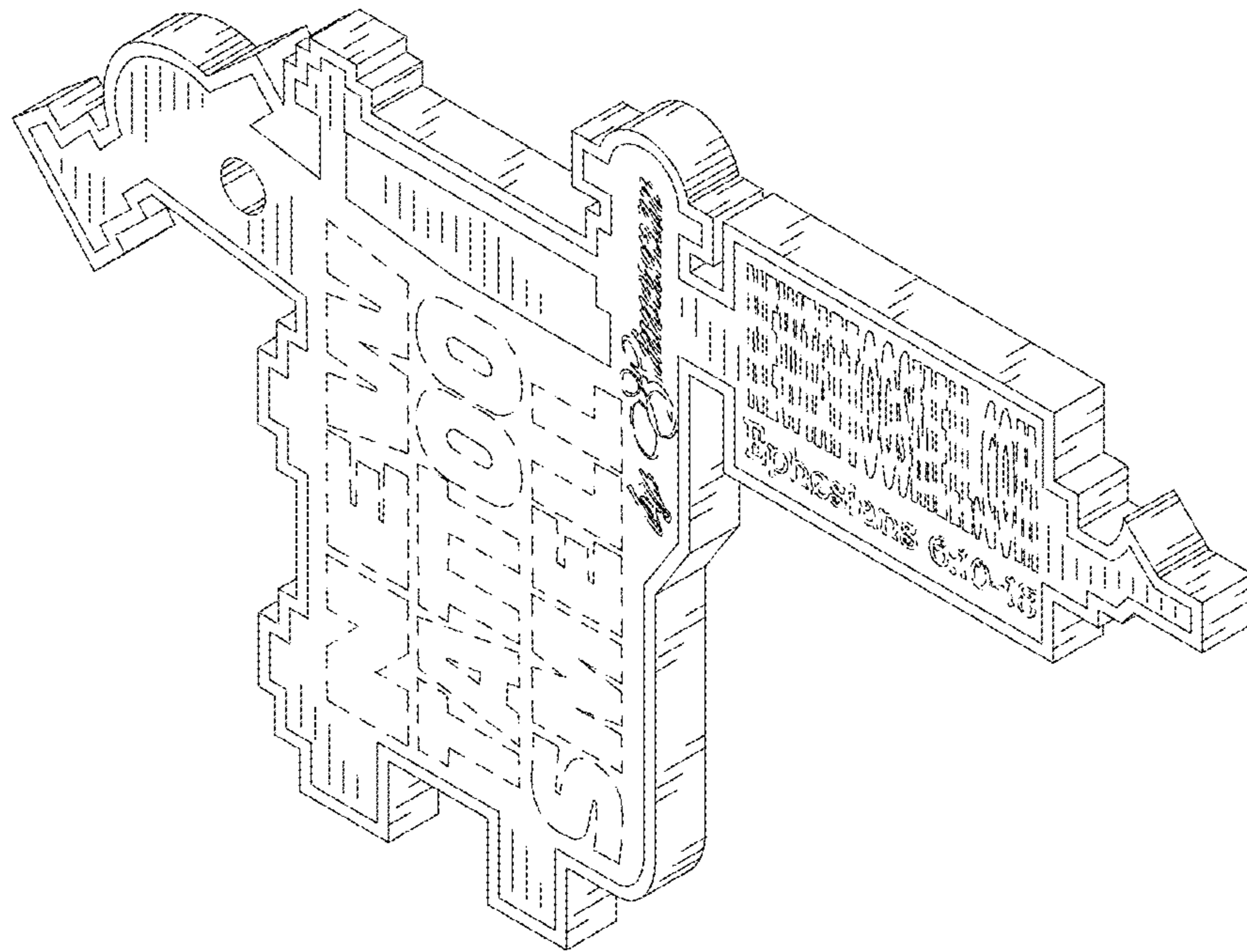

FIG. 7