



US00D800866S

(12) **United States Design Patent**
Lestander

(10) **Patent No.:** **US D800,866 S**

(45) **Date of Patent:** **** Oct. 24, 2017**

(54) **FISHING LURE**

(71) Applicant: **Headbanger Lure AB**, Luleå (SE)

(72) Inventor: **Dan Lestander**, Luleå (SE)

(73) Assignee: **Headbanger Lure AB**, Luleå (SE)

(**) Term: **15 Years**

(21) Appl. No.: **29/556,882**

(22) Filed: **Mar. 3, 2016**

(30) **Foreign Application Priority Data**

Mar. 2, 2016 (EM) 003009786-0002

(51) **LOC (10) Cl.** **22-05**

(52) **U.S. Cl.**
USPC **D22/126**

(58) **Field of Classification Search**
USPC D22/126-133; 43/35, 42.15, 42.34
CPC A01K 85/00; A01K 85/02; A01K 85/16
See application file for complete search history.

(56) **References Cited**

U.S. PATENT DOCUMENTS

2,012,786 A 8/1935 Hoage
2,394,132 A 2/1946 Zeibig
2,425,658 A * 8/1947 Urban A01K 85/02
43/35
D178,560 S * 8/1956 Wiegand D22/133

(Continued)

FOREIGN PATENT DOCUMENTS

DE 10 2010 047 372 A1 4/2012
FR 2 652 991 A1 4/1991

(Continued)

OTHER PUBLICATIONS

European Supplementary Search Report mailed May 11, 2016, issued in corresponding European Application No. 13 848 217.9, filed Oct. 18, 2013, 9 pages.

(Continued)

Primary Examiner — Catherine R Oliver-Garcia

(74) *Attorney, Agent, or Firm* — Christensen O'Connor Johnson Kindness PLLC

(57) **CLAIM**

The ornamental design for a fishing lure, as shown and described.

DESCRIPTION

FIG. 1 is a top perspective view of the design of a fishing lure of the present application;
FIG. 2 is a bottom perspective view of the design in FIG. 1;
FIG. 3 is a side elevational view of the design in FIG. 1, with the opposite side at elevational view being a mirror image thereof;
FIG. 4 is a front elevational view of the design in FIG. 1;
FIG. 5 is a rear elevational view of the design in FIG. 1;
FIG. 6 is a top view of the design in FIG. 1;
FIG. 7 is a bottom view of the design in FIG. 1;
FIG. 8 is a top perspective view of a second embodiment of the design of a fishing lure of the present application;
FIG. 9 is a bottom perspective view of the design in FIG. 8;
FIG. 10 is a side elevational view of the design in FIG. 8, with the opposite side at elevational view being a mirror image thereof;
FIG. 11 is a front elevational view of the design in FIG. 8;
FIG. 12 is a rear elevational view of the design in FIG. 8;
FIG. 13 is a top view of the design in FIG. 8; and,
FIG. 14 is a bottom view of the design in FIG. 8.
The elements depicted in broken line and/or in phantom line in the figures are included for environmental purposes only, and form no part of the claimed design.

1 Claim, 14 Drawing Sheets

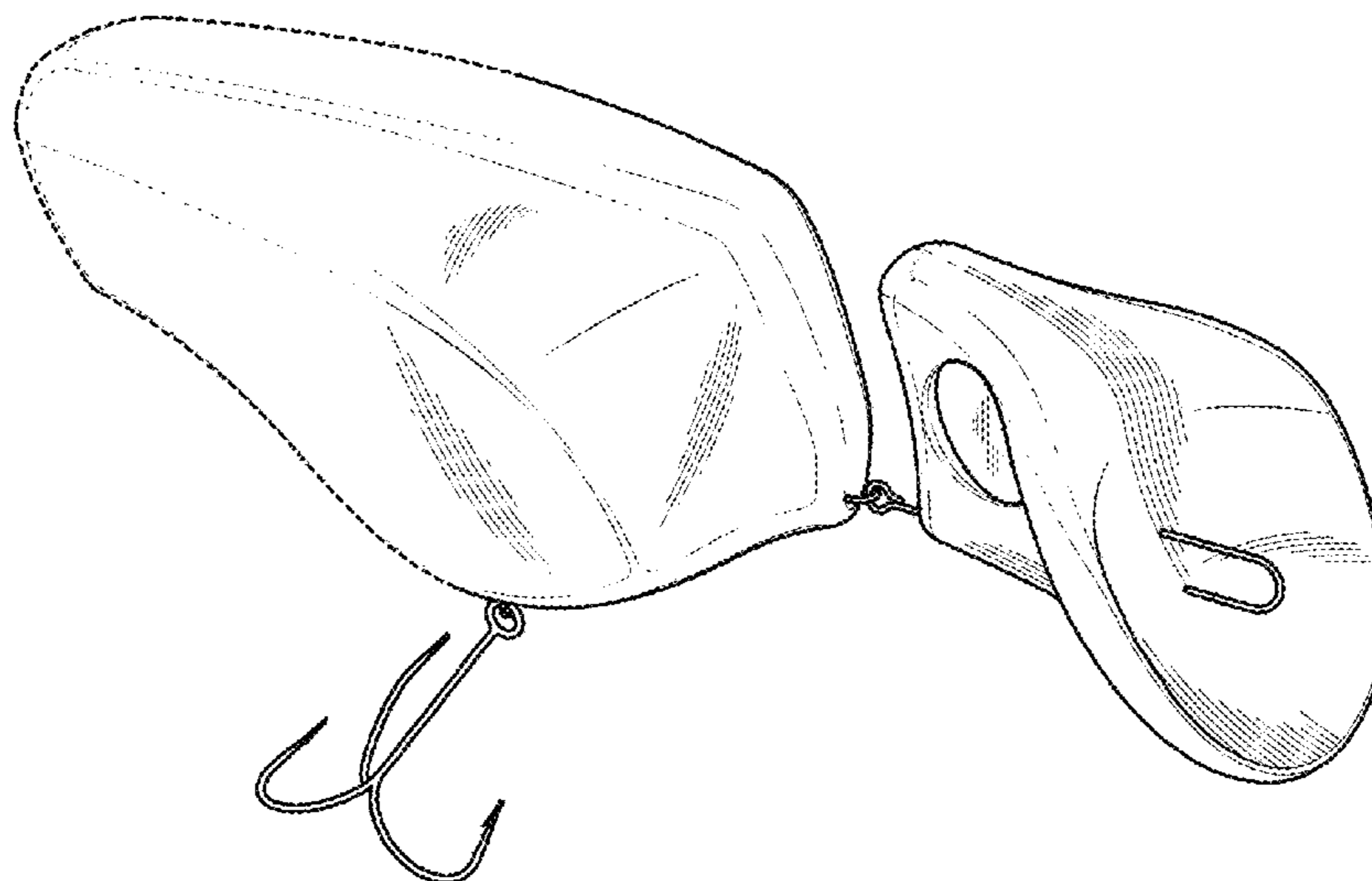

(56)

References Cited

U.S. PATENT DOCUMENTS

2,780,884 A 2/1957 Hadfield
2,836,922 A 6/1958 Cox
3,238,660 A 3/1966 Pcola
3,497,986 A 3/1970 Bianco
3,815,275 A 6/1974 Amundson
D267,106 S * 11/1982 Erb D22/126
4,468,879 A 9/1984 Anson
4,658,535 A 4/1987 Anderson
4,807,388 A 2/1989 Cribb
4,959,920 A 10/1990 Walker
5,216,830 A 6/1993 Brott, II
5,893,232 A 4/1999 Horton et al.
5,918,406 A 7/1999 Wilson
5,934,007 A 8/1999 Ellestad
D511,367 S * 11/2005 Bowling D22/126
7,107,720 B2 9/2006 Burggrabe et al.

D570,442 S * 6/2008 Gettings D22/126
7,895,789 B2 3/2011 Langer
D679,361 S * 4/2013 Anderson D22/126
8,806,802 B2 8/2014 Jones

FOREIGN PATENT DOCUMENTS

GB 15106 0/1908
GB 745508 2/1956
JP 2005-210951 A 8/2005
SE 1200649 A1 4/2014
WO 2014/065737 A1 5/2014

OTHER PUBLICATIONS

International Search Report mailed Feb. 3, 2014, issued in corresponding International Application No. PCT/SE2013/000159, filed Oct. 18, 2013, 4 pages.

* cited by examiner

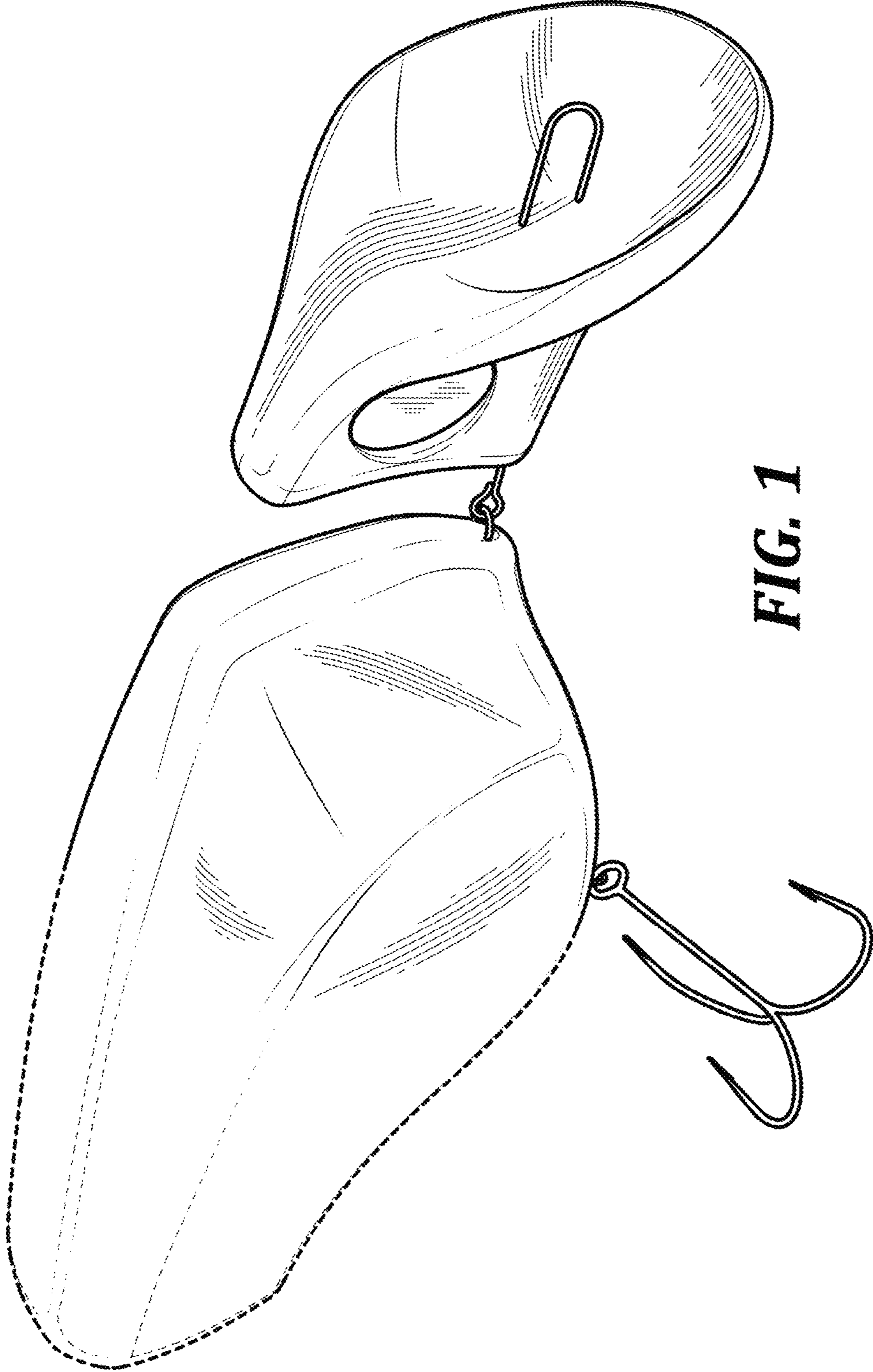

FIG. 1

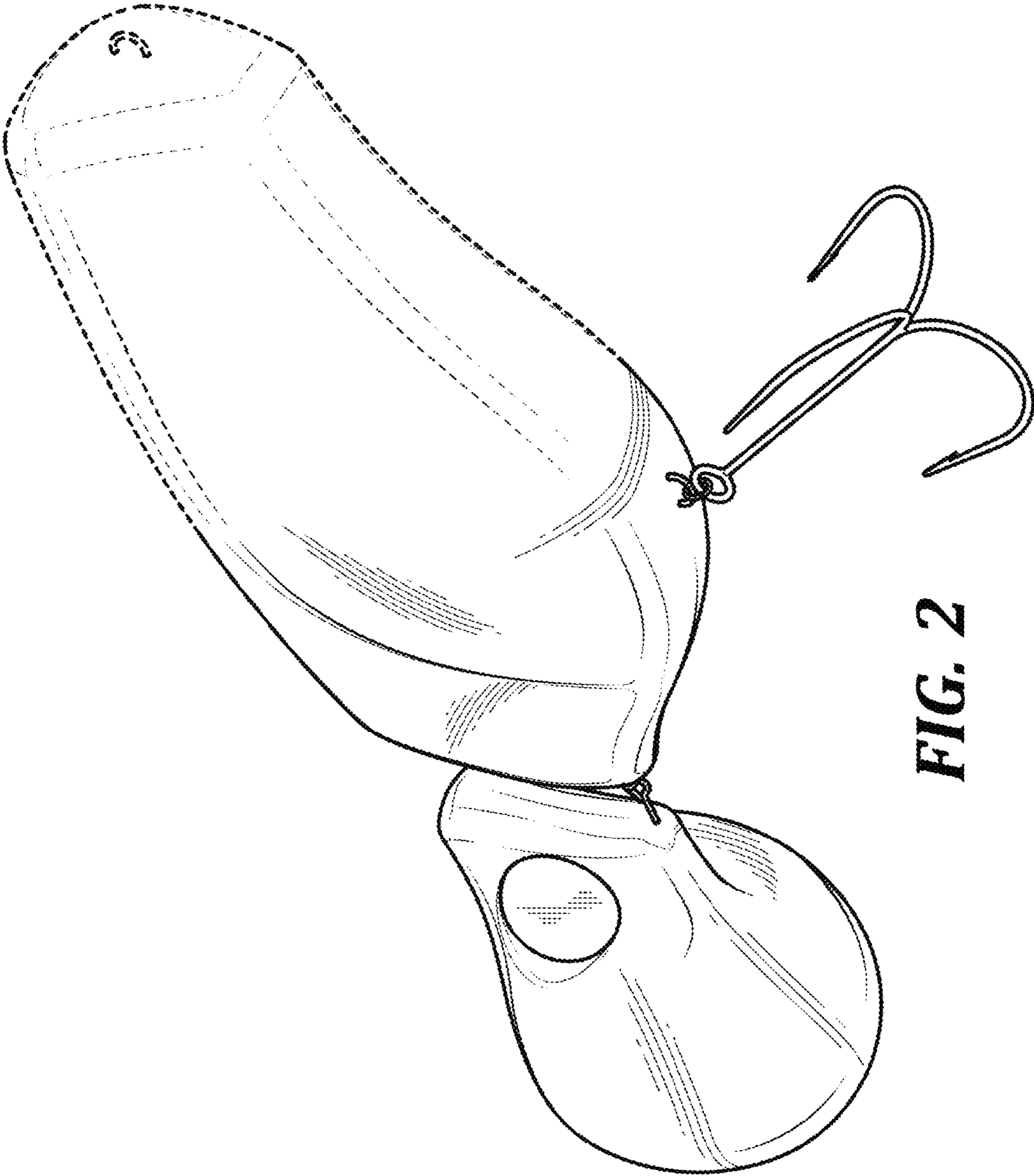

FIG. 2

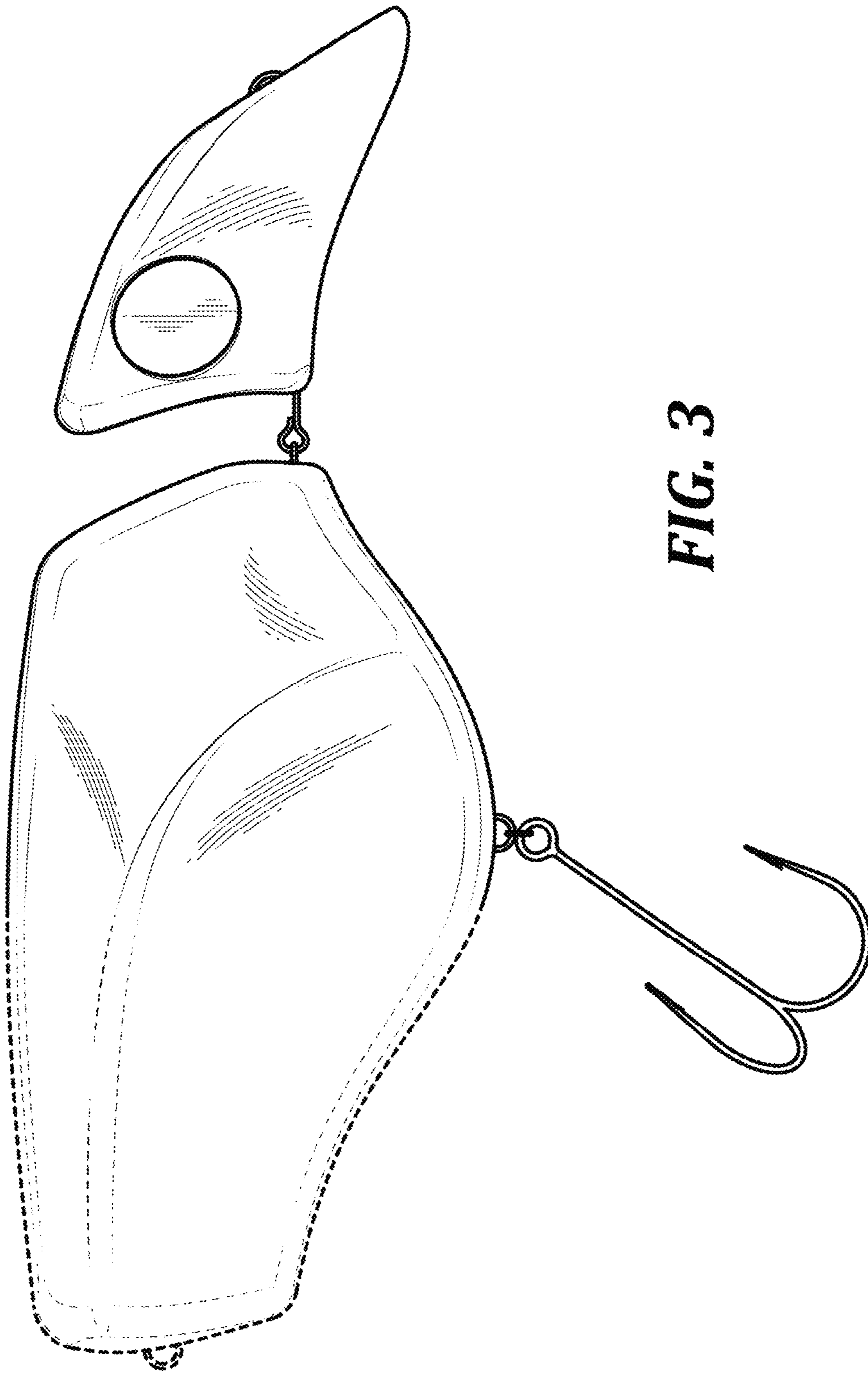

FIG. 3

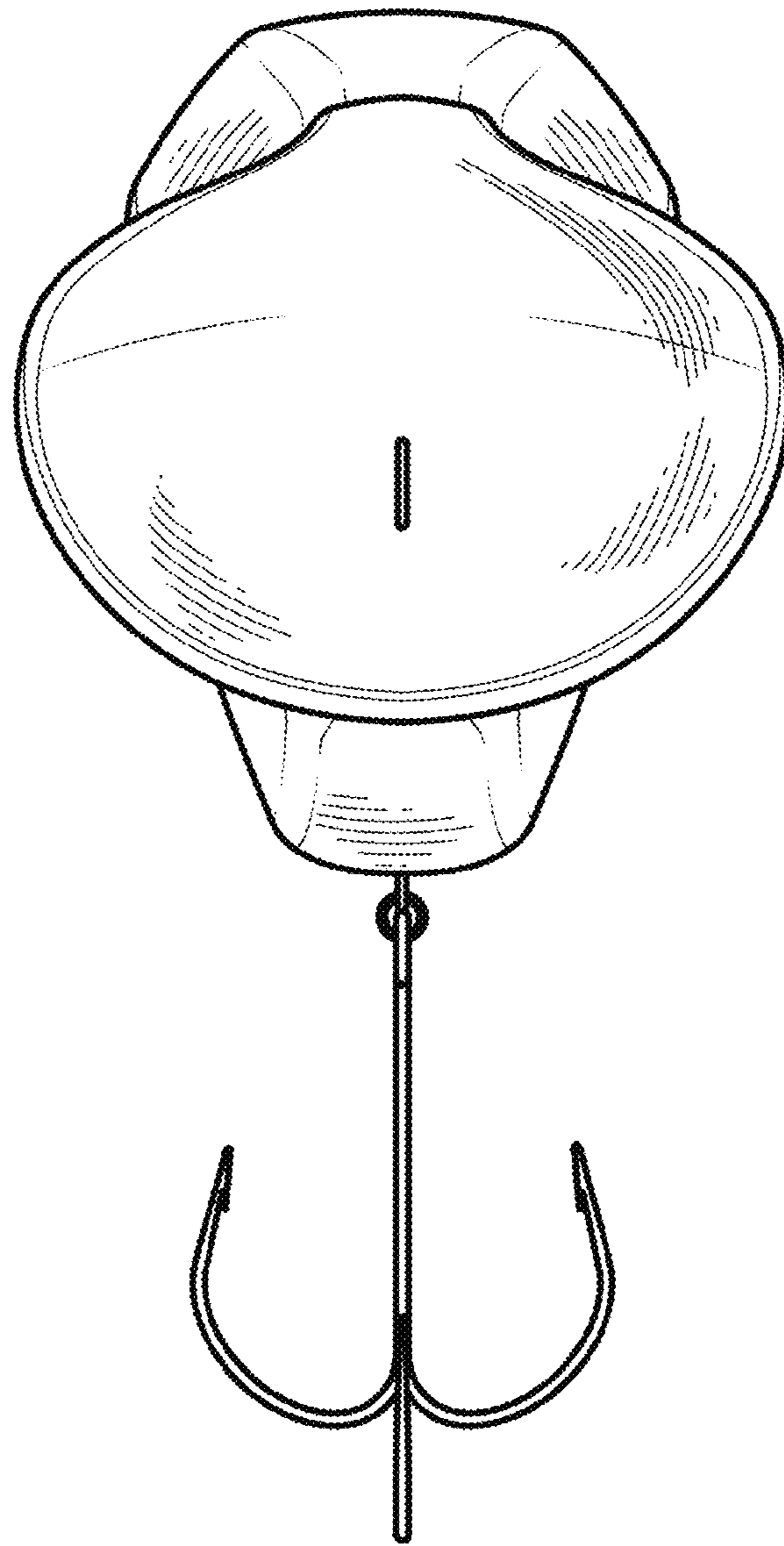

FIG. 4

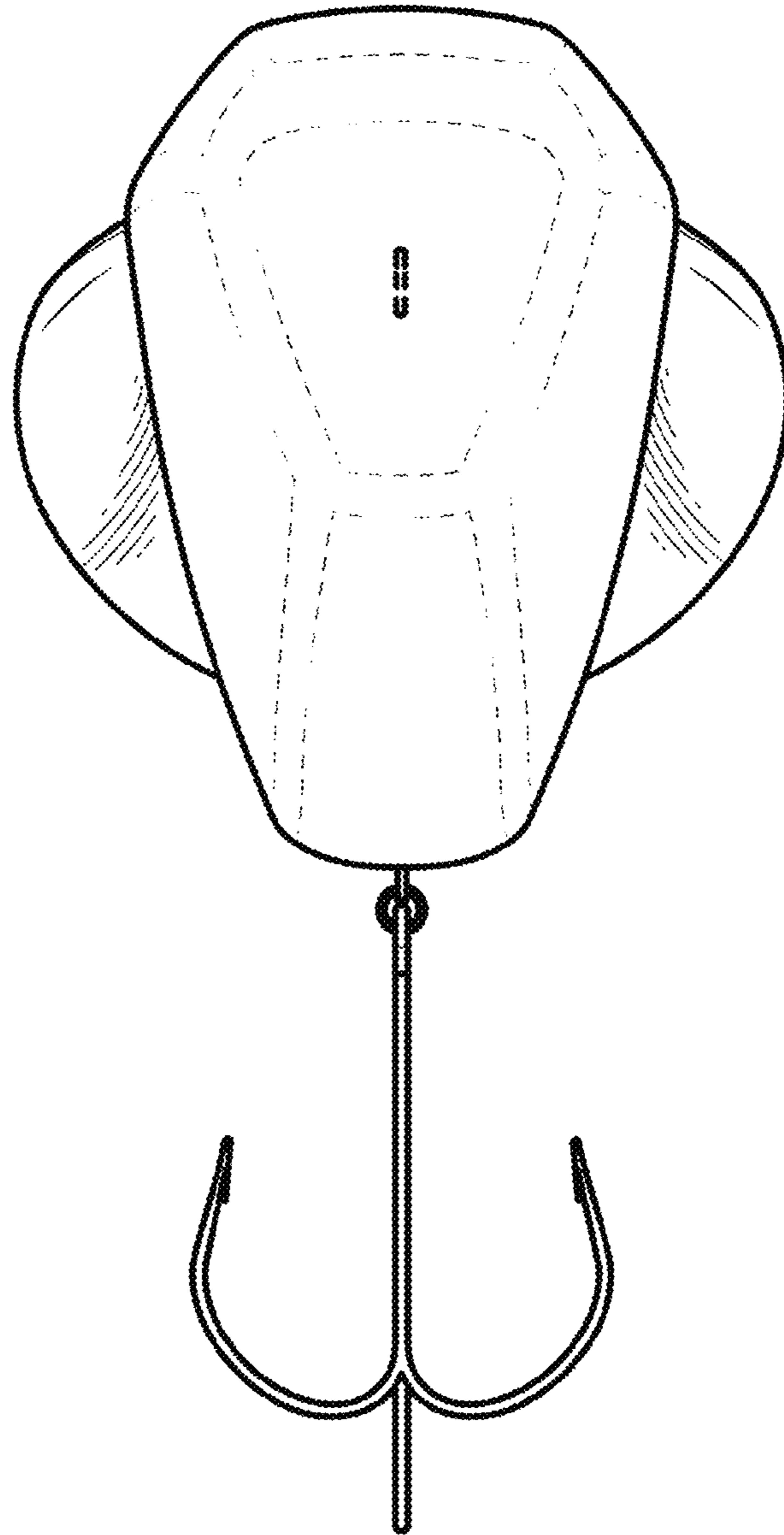

FIG. 5

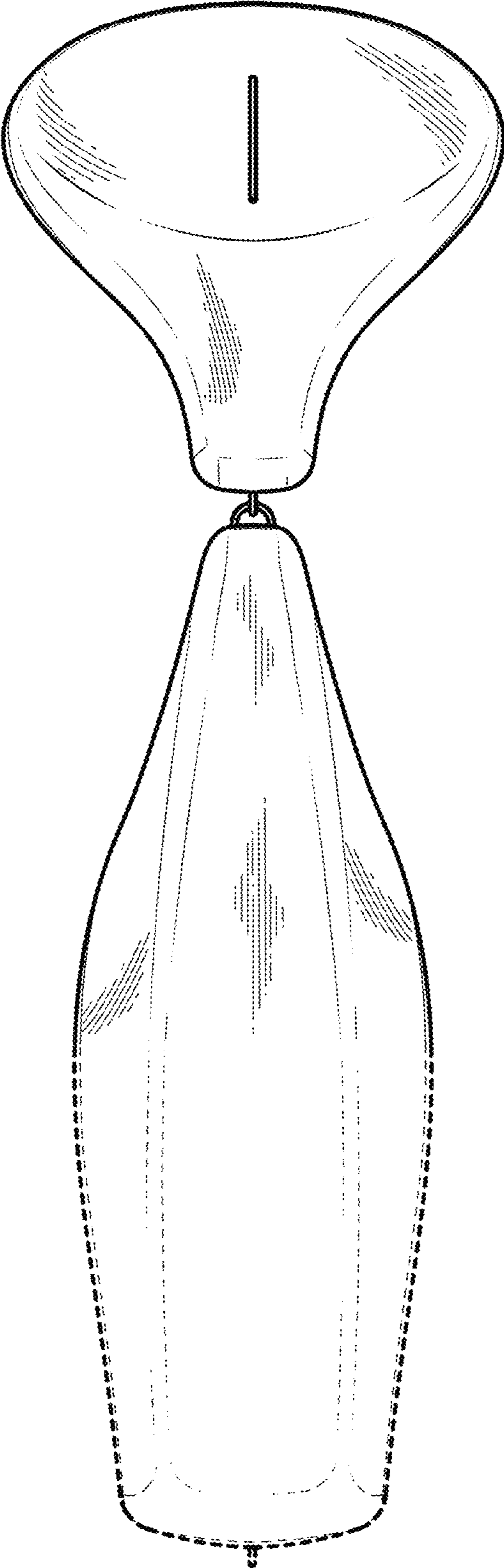

FIG. 6

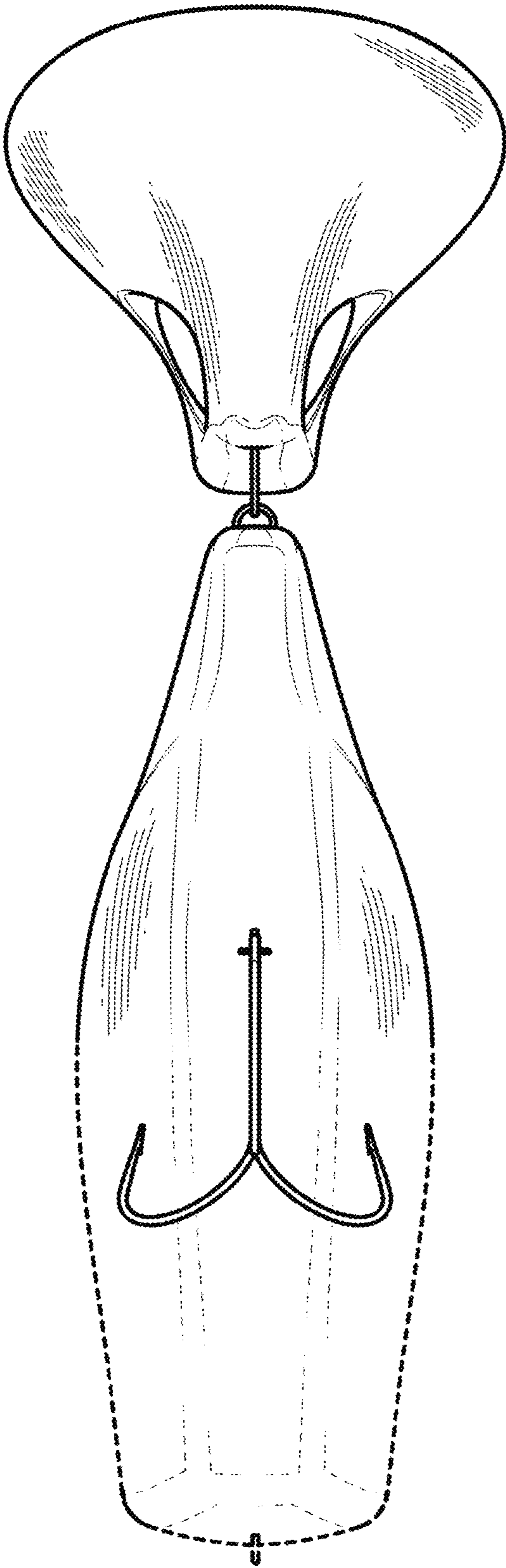

FIG. 7



FIG. 8

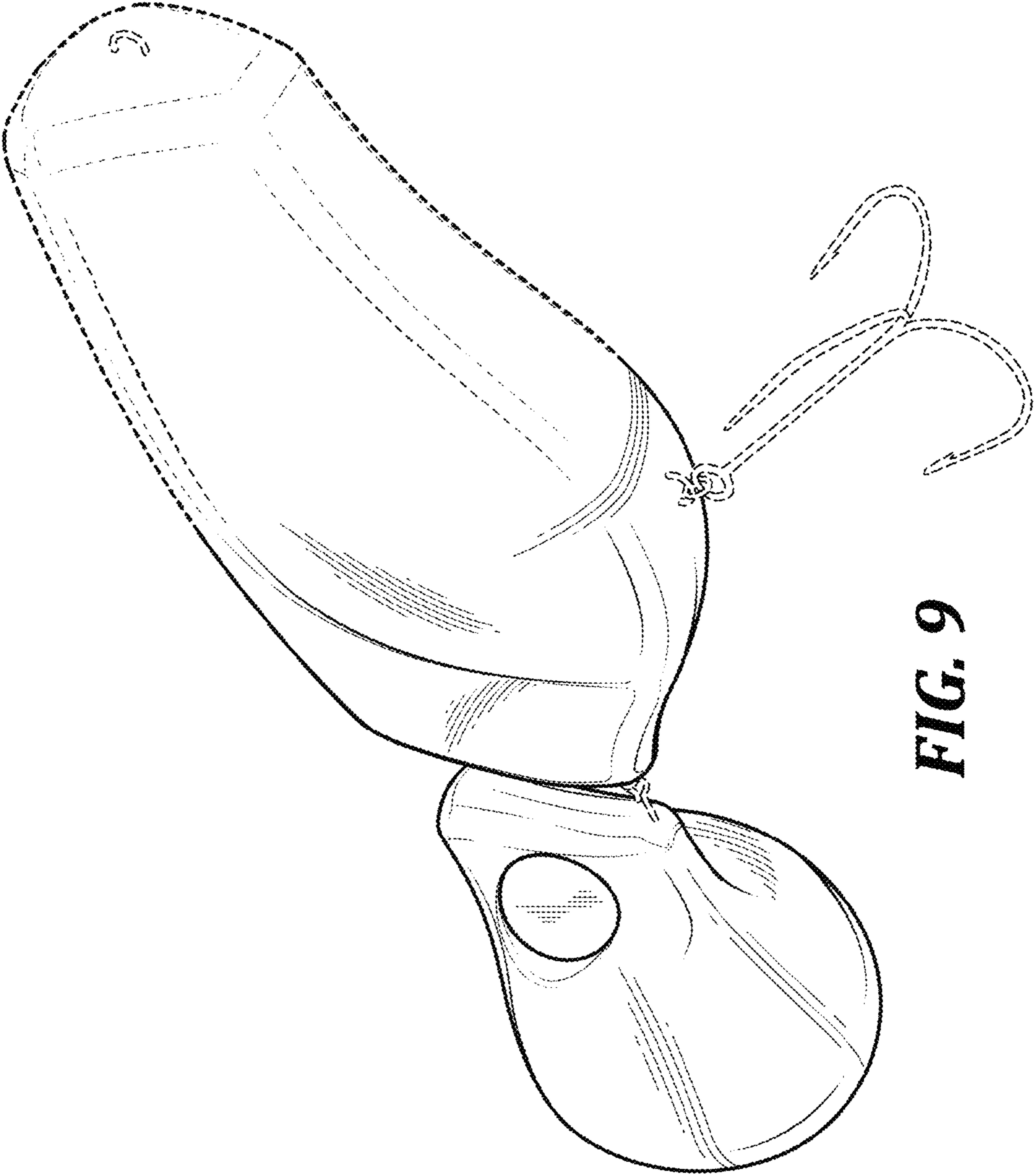

FIG. 9

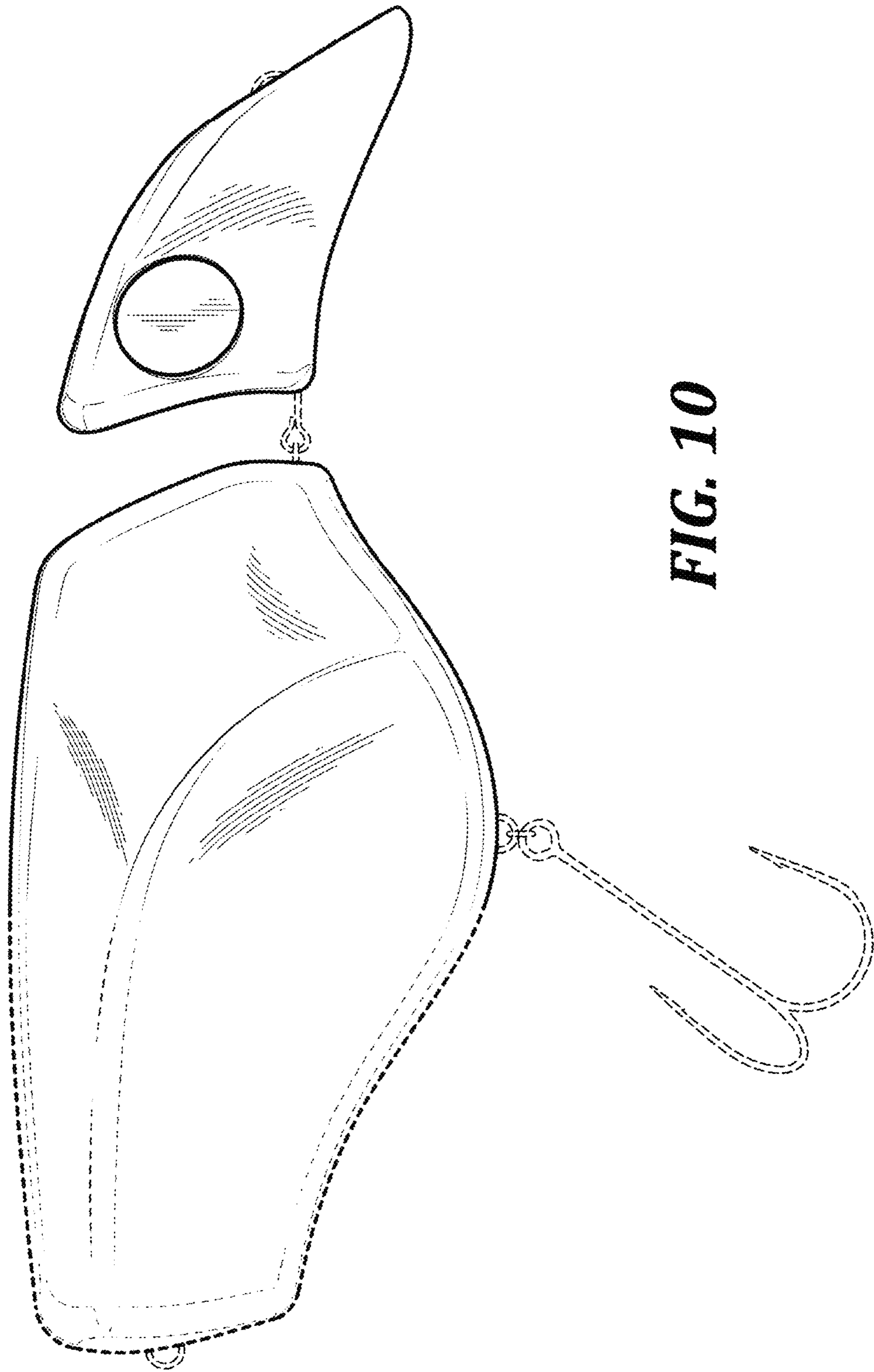

FIG. 10

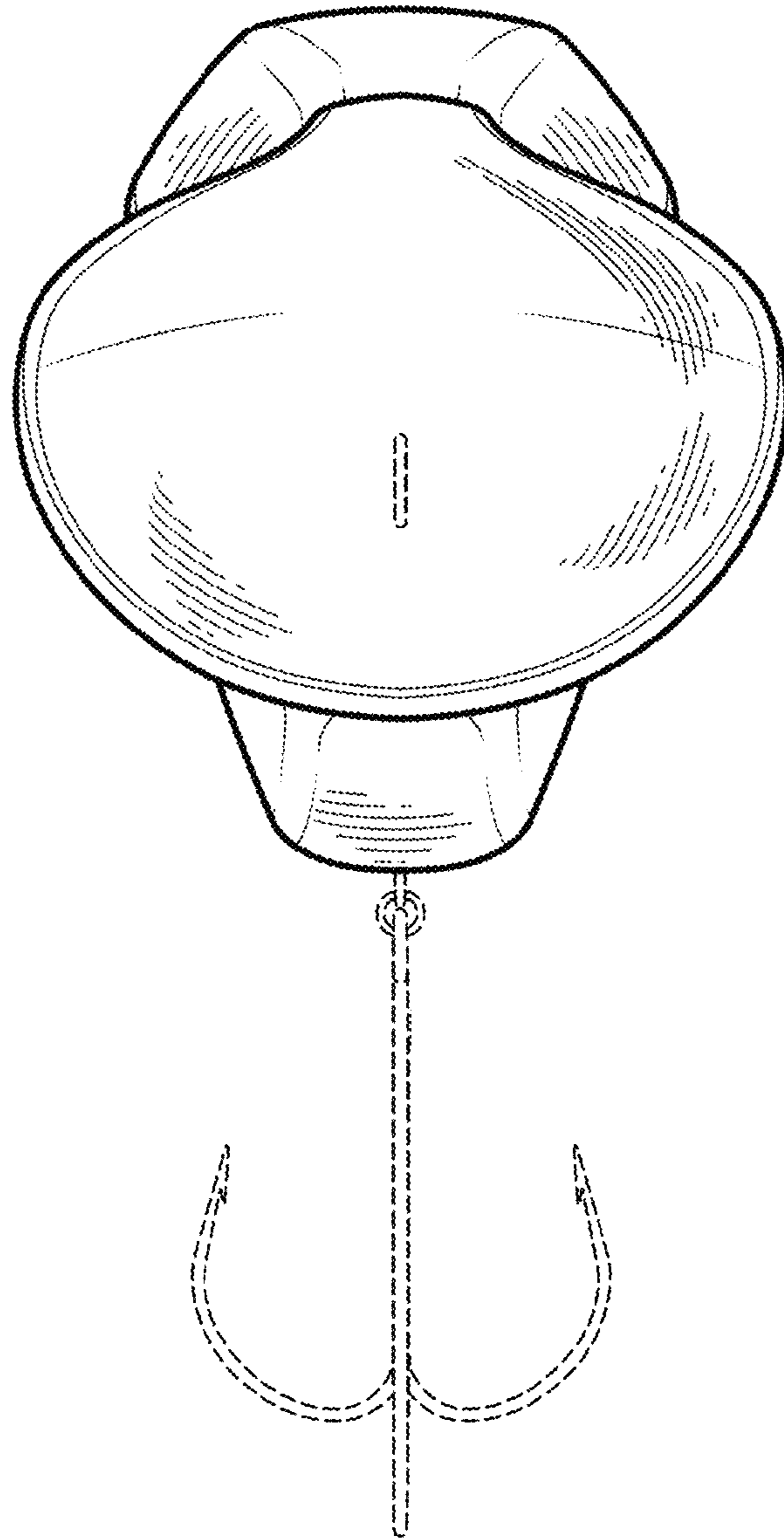

FIG. 11

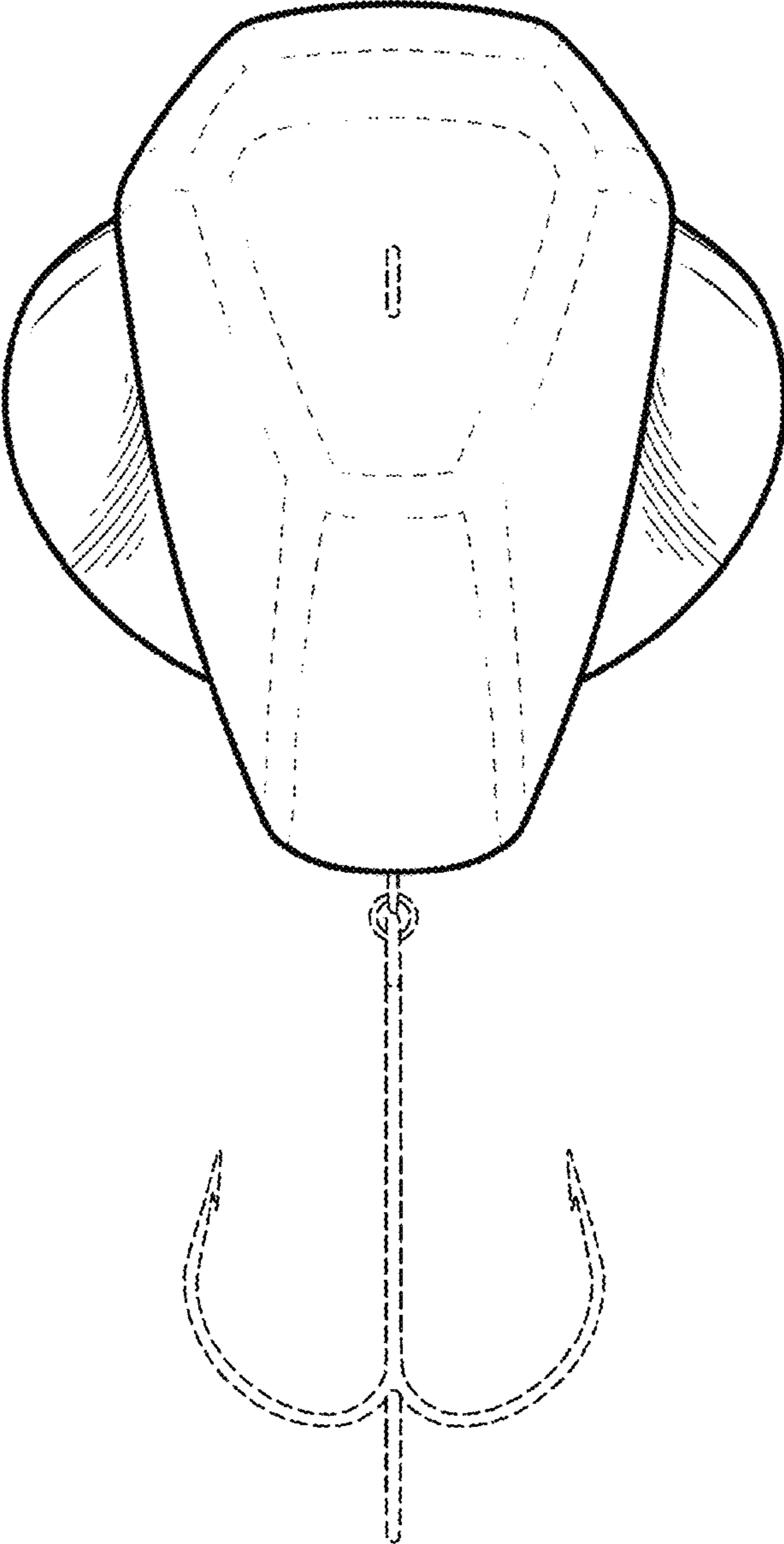

FIG. 12

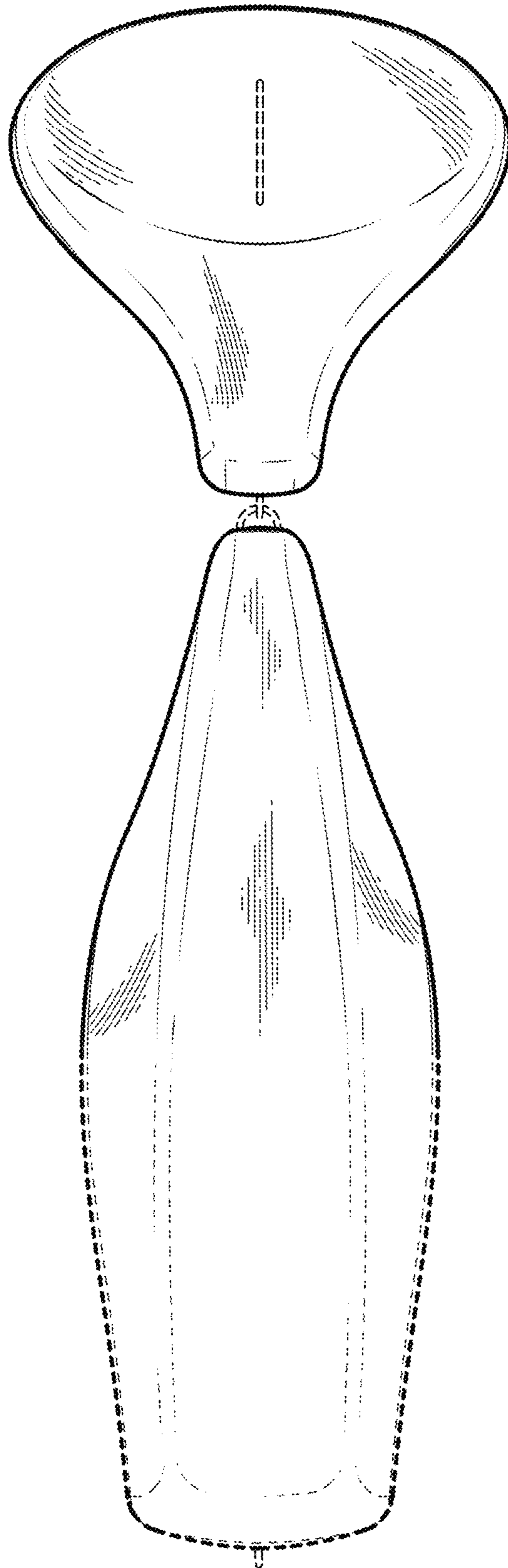

FIG. 13

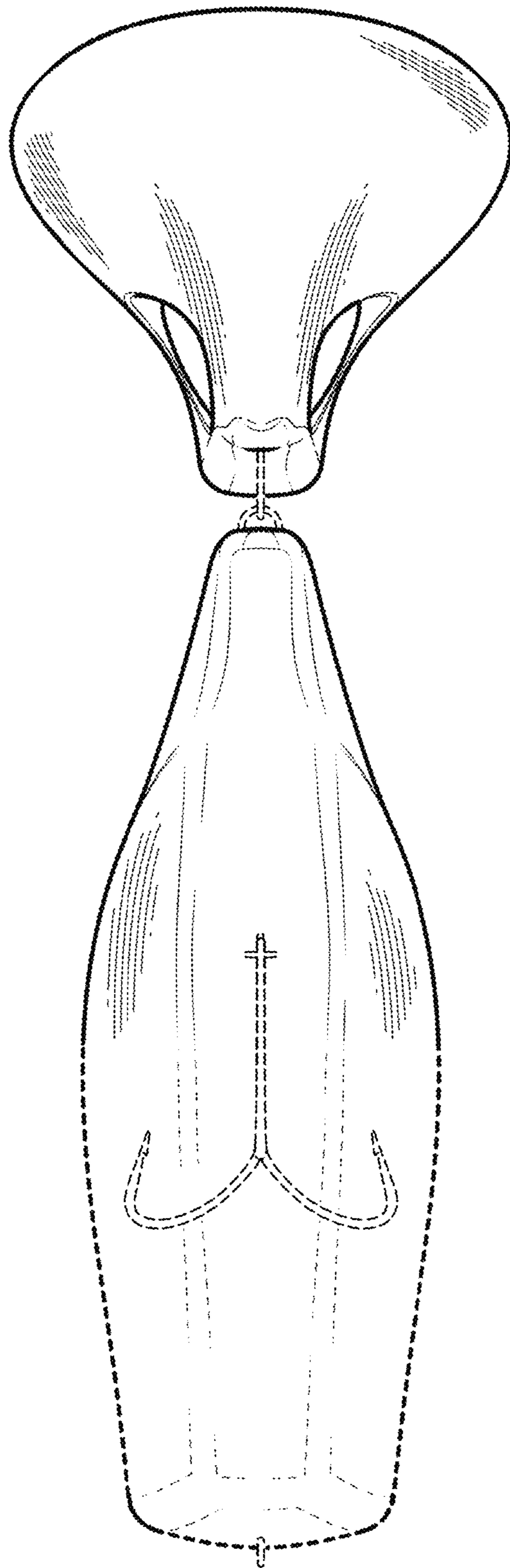

FIG. 14