



US00D800760S

(12) **United States Design Patent** (10) **Patent No.:** **US D800,760 S**  
**Delgado et al.** (45) **Date of Patent:** **\*\* Oct. 24, 2017**

(54) **DISPLAY SCREEN OR PORTION THEREOF WITH GRAPHICAL USER INTERFACE**

(71) Applicant: **Honeywell International Inc.**, Morris Plains, NJ (US)

(72) Inventors: **Alejandra Gonzalez Delgado**, Calgary (CA); **Jacob Thomas Spector**, Calgary (CA)

(73) Assignee: **Honeywell International Inc.**, Morris Plains, NJ (US)

(\*\*) Term: **15 Years**

(21) Appl. No.: **29/544,088**

(22) Filed: **Oct. 30, 2015**

(51) **LOC (10) Cl.** ..... **14-04**

(52) **U.S. Cl.**  
USPC ..... **D14/487; D14/488**

(58) **Field of Classification Search**  
USPC ..... D14/485-495; 345/1.1, 1.2, 2.1-2.3, 3.1, 345/902; 715/763, 810, 836, 837, 846, 715/847, 977

(Continued)

(56) **References Cited**

**U.S. PATENT DOCUMENTS**

D475,064 S \* 5/2003 Nashida ..... D14/489  
D496,667 S \* 9/2004 Hoglund ..... D14/489

(Continued)

**FOREIGN PATENT DOCUMENTS**

CN ZL201630163819.X 11/2016

**OTHER PUBLICATIONS**

“Envelope with Downwards Arrow Above Emoji.” emoji.co.uk. Date not available. Accessed Jun. 2, 2017. Available online at URL: <<http://www.emoji.co.uk/view/704/>>.\*

(Continued)

*Primary Examiner* — Cathron Brooks  
*Assistant Examiner* — Christian P McLean  
(74) *Attorney, Agent, or Firm* — Conley Rose, P.C.;  
Kristin Jordan Harkins

(57) **CLAIM**

The ornamental design for a display screen or portion thereof with graphical user interface, as shown and described.

**DESCRIPTION**

FIG. 1 is a front view of a “display screen or portion thereof with graphical user interface.”

FIG. 2 is another view thereof, depicting an alternative environment;

FIG. 3 is another view thereof, depicting an alternative environment;

FIG. 4 is another view thereof, depicting an alternative environment;

FIG. 5 is another view thereof, depicting an alternative environment;

FIG. 6 is another view thereof, depicting an alternative environment;

FIG. 7 is another view thereof, depicting an alternative environment;

FIG. 8 is another view thereof, depicting an alternative environment;

FIG. 9 is another view thereof, depicting an alternative environment;

FIG. 10 is another view thereof, depicting an alternative environment;

FIG. 11 is another view thereof, depicting an alternative environment;

FIG. 12 is another view thereof, depicting an alternative environment;

FIG. 13 is another view thereof, depicting an alternative environment;

FIG. 14 is another view thereof, depicting an alternative environment;

FIG. 15 is another view thereof, depicting an alternative environment;

FIG. 16 is another view thereof, depicting an alternative environment; and,

(Continued)

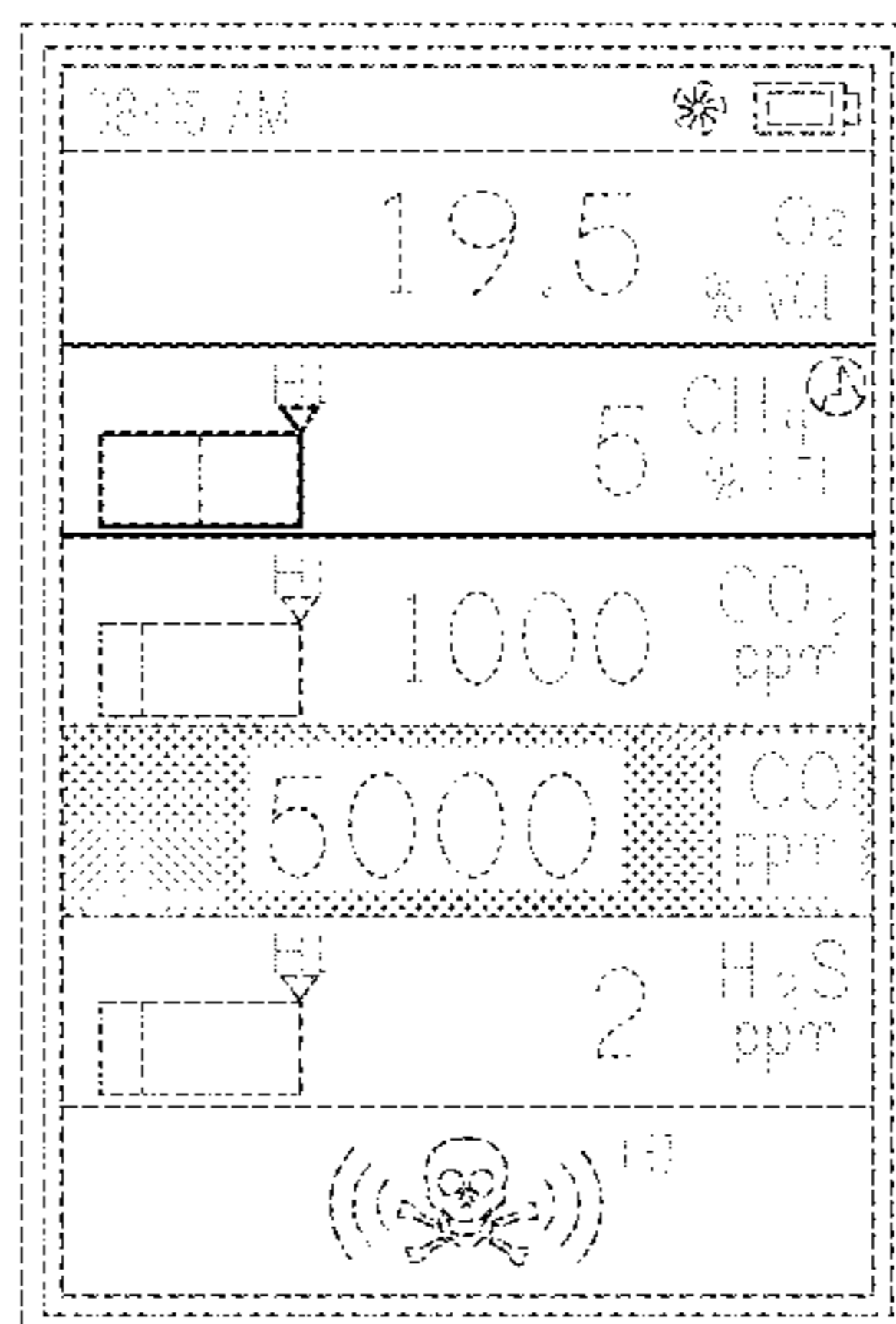

FIG. 17 is another view thereof, depicting an alternative environment.

The outermost broken lines show a display screen or portion thereof and form no part of the claimed design. The remaining broken lines, showing portions of the graphical user interface, form no part of the claimed design. The dot pattern in FIGS. 13-16 forms no part of the claimed design.

**1 Claim, 9 Drawing Sheets**

(58) **Field of Classification Search**

CPC .... G06F 3/048; G06F 3/0481; G06F 3/04812; G06F 3/04817; G06F 3/0482; G06F 3/0483; G06F 3/0484; G06F 3/04847; G06F 3/0485; G06F 3/04855; G06F 3/04886; G06Q 30/00; H03J 1/00; H03J 1/0008; H03J 1/0016; H03J 1/0025; H04N 5/00; H04N 5/08; H04N 5/14; H04N 5/222; H04N 5/225; H04N 5/232; H04N 5/445; H04N 5/44543; H04N 5/45; H04N 2005/44517; H04N 2005/44521; H04N 2005/44526; H04N 2005/4453; H04N 2005/44534; H04N 2005/44539; H04N 2005/44547; H04N 2005/44556; H04N 2005/4456; H04N 2005/44565; H04N 2005/44569; H04N 2005/44573; H04N 21/00; H04N 21/234; H04N 21/431; H04N 21/4312; H04N 21/4314; H04N 21/4316

See application file for complete search history.

(56) **References Cited**

U.S. PATENT DOCUMENTS

D525,981 S \* 8/2006 Hally ..... D14/485  
 D557,268 S \* 12/2007 Fletcher ..... D14/485  
 D563,423 S \* 3/2008 Suzuki ..... D14/486  
 D577,364 S \* 9/2008 Flynt ..... D14/486  
 D577,366 S \* 9/2008 Flynt ..... D14/486  
 D596,194 S \* 7/2009 Vu ..... D14/488  
 7,707,514 B2 \* 4/2010 Forstall ..... G06F 3/0486  
 715/741  
 D631,060 S \* 1/2011 Flik ..... D14/486  
 D650,788 S \* 12/2011 Marks ..... D14/487  
 D671,552 S \* 11/2012 Mori ..... D14/486  
 8,370,762 B2 \* 2/2013 Abbott ..... G06F 3/04817  
 345/173

D681,660 S \* 5/2013 Matas ..... D14/486  
 D701,233 S \* 3/2014 Heong ..... D14/486  
 D701,521 S \* 3/2014 Kim ..... D14/486  
 8,793,606 B2 \* 7/2014 Kim ..... G06F 3/04817  
 345/173  
 D715,820 S \* 10/2014 Rebstock ..... D14/486  
 D718,779 S \* 12/2014 Hang Sik ..... D14/486  
 D720,766 S \* 1/2015 Mandal ..... D14/486  
 D722,071 S \* 2/2015 Kim ..... D14/486  
 D725,666 S \* 3/2015 Tseng ..... D14/486  
 D727,337 S \* 4/2015 Kim ..... D14/486  
 D730,364 S \* 5/2015 Inose ..... D14/485  
 D740,312 S \* 10/2015 Heo ..... D14/487  
 D742,914 S \* 11/2015 Daniel ..... D14/489  
 D744,501 S \* 12/2015 Wilberding ..... D14/485  
 D745,045 S \* 12/2015 Heeter ..... D14/489  
 D748,114 S \* 1/2016 Leyon ..... D14/486  
 D755,193 S \* 5/2016 Sun ..... D14/485  
 D755,818 S \* 5/2016 Seo ..... D14/486  
 D757,791 S \* 5/2016 van Os ..... D14/488  
 D758,446 S \* 6/2016 Lv ..... D14/494  
 D759,687 S \* 6/2016 Chang ..... D14/486  
 D760,775 S \* 7/2016 Chen ..... D14/489  
 D762,685 S \* 8/2016 Eom ..... D14/486  
 D765,105 S \* 8/2016 Virk ..... D14/485  
 D765,110 S \* 8/2016 Liang ..... D14/486  
 D766,976 S \* 9/2016 McElreath ..... D14/491  
 D772,282 S \* 11/2016 Kwon ..... D14/488  
 D772,894 S \* 11/2016 Zhao ..... D14/485  
 D781,909 S \* 3/2017 Capela ..... D14/487  
 D782,523 S \* 3/2017 Baumann ..... D14/488  
 2011/0197163 A1 \* 8/2011 Jegal ..... G06F 3/0482  
 715/811  
 2012/0151381 A1 \* 6/2012 Schiff ..... G06F 8/34  
 715/752  
 2013/0215023 A1 \* 8/2013 Bourret ..... G06F 3/013  
 345/157  
 2014/0337791 A1 \* 11/2014 Agnetta ..... G06F 3/0481  
 715/784  
 2016/0103650 A1 \* 4/2016 Lim ..... H04N 21/43615  
 345/2.2  
 2016/0170613 A1 \* 6/2016 Shin ..... G06F 3/0482  
 715/810  
 2016/0171417 A1 \* 6/2016 Sankaralingham .....  
 G06Q 10/06398  
 705/7.42

**OTHER PUBLICATIONS**

Community Design Registration No. 003070283-0001, Notice of Registration of Community Design, dated Jun. 9, 2016, 6 pages.  
 China Patent Application No. 201630163819.X, Notice to Grant Patent Right, dated Aug. 25, 2016, 5 pages.

\* cited by examiner

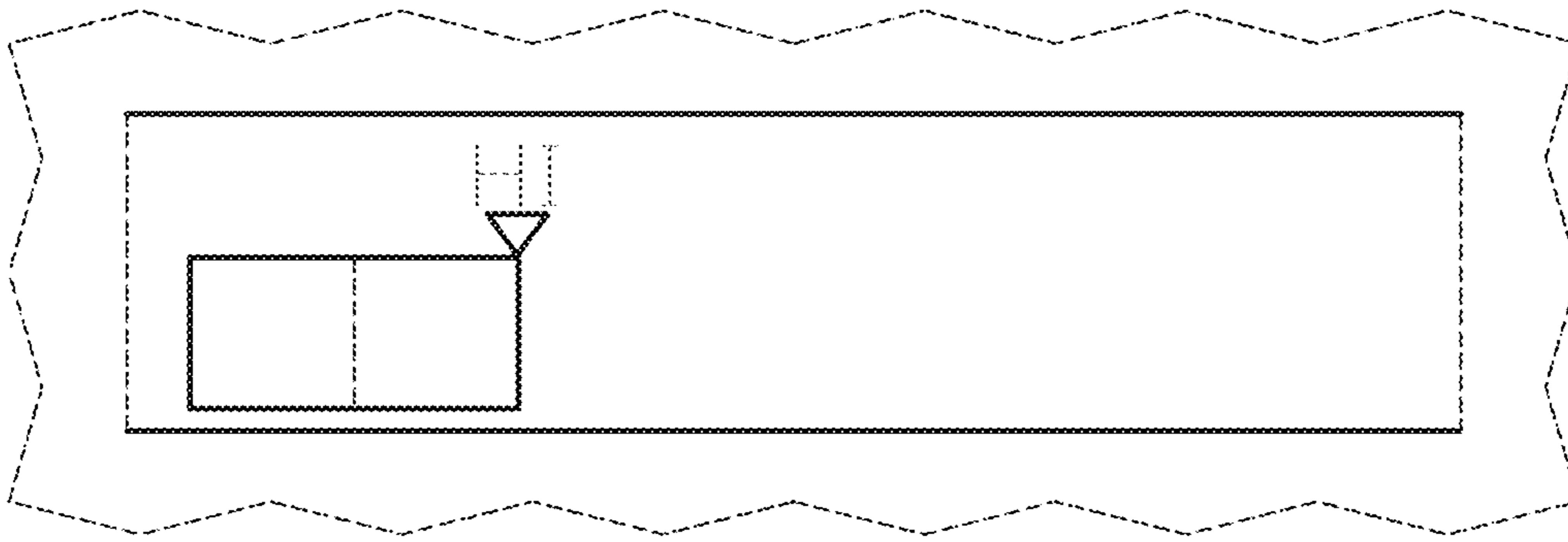

FIG. 1

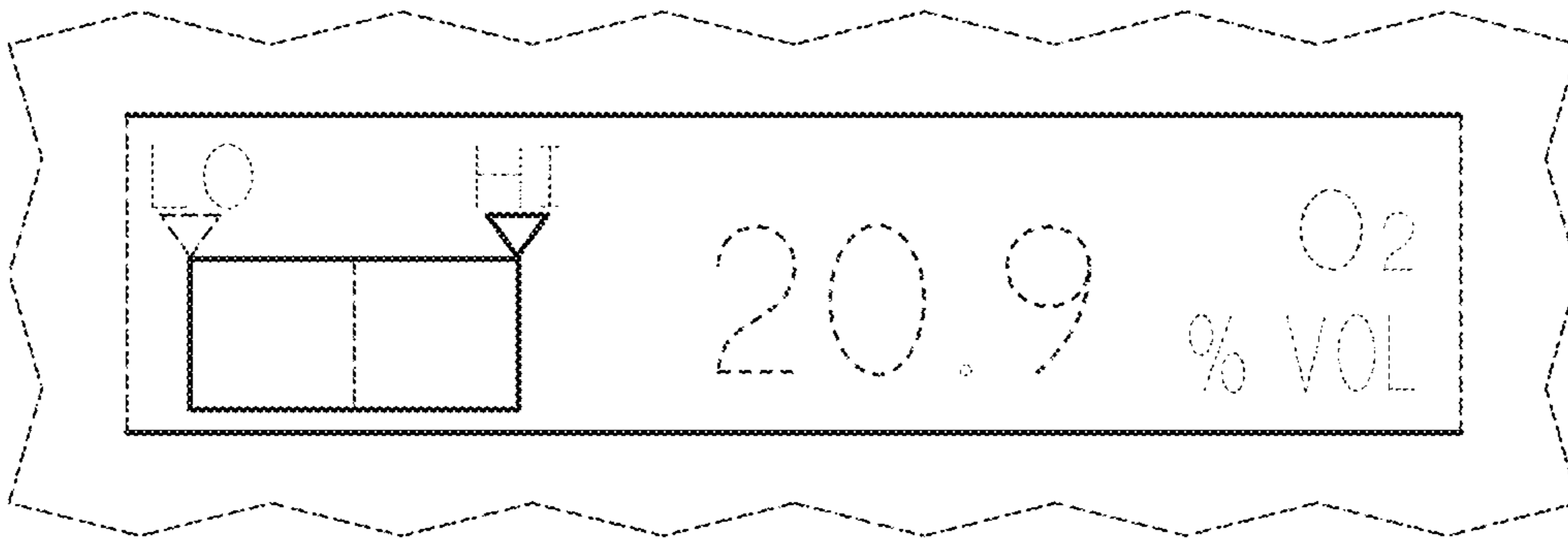

FIG. 2

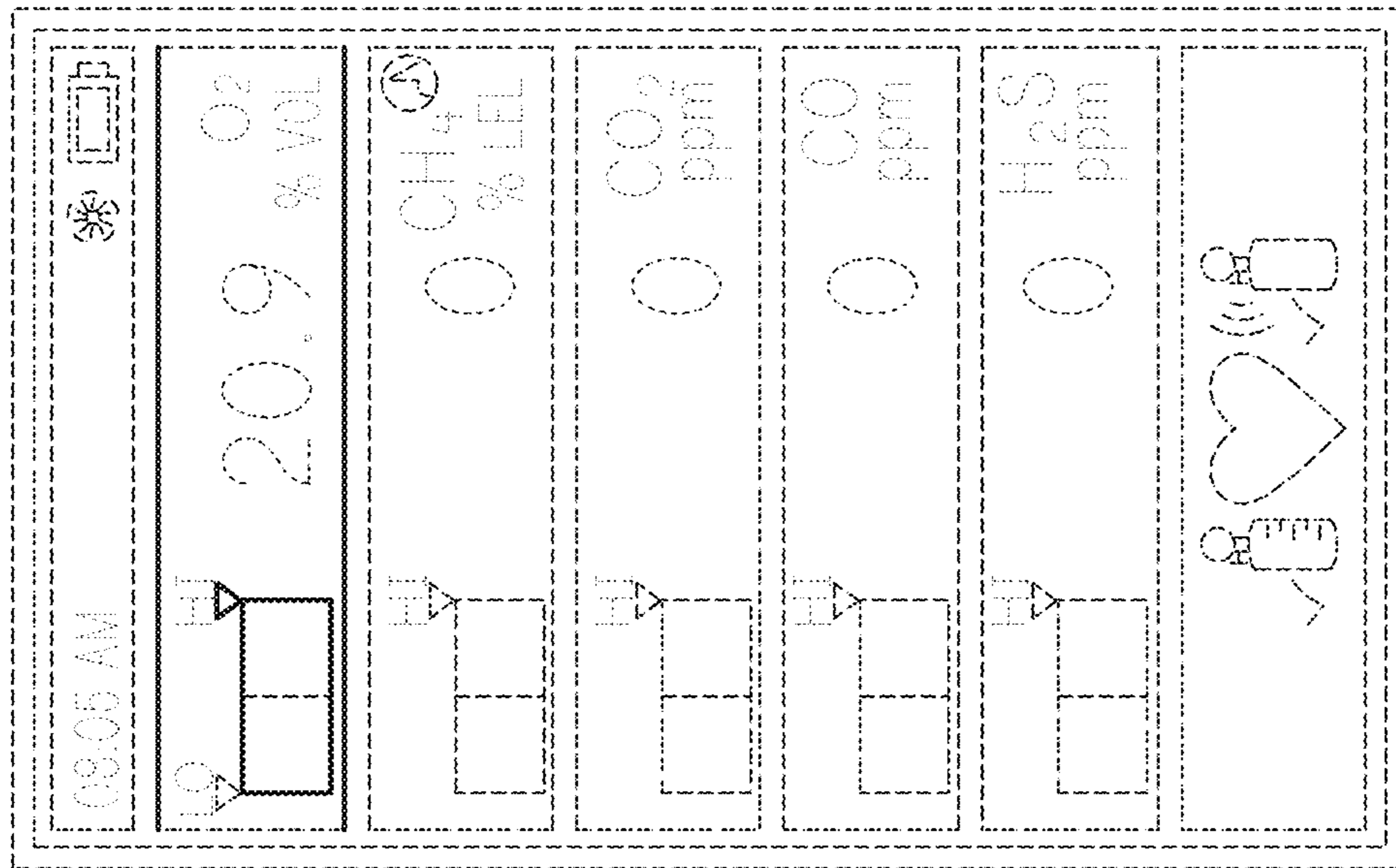

FIG. 3

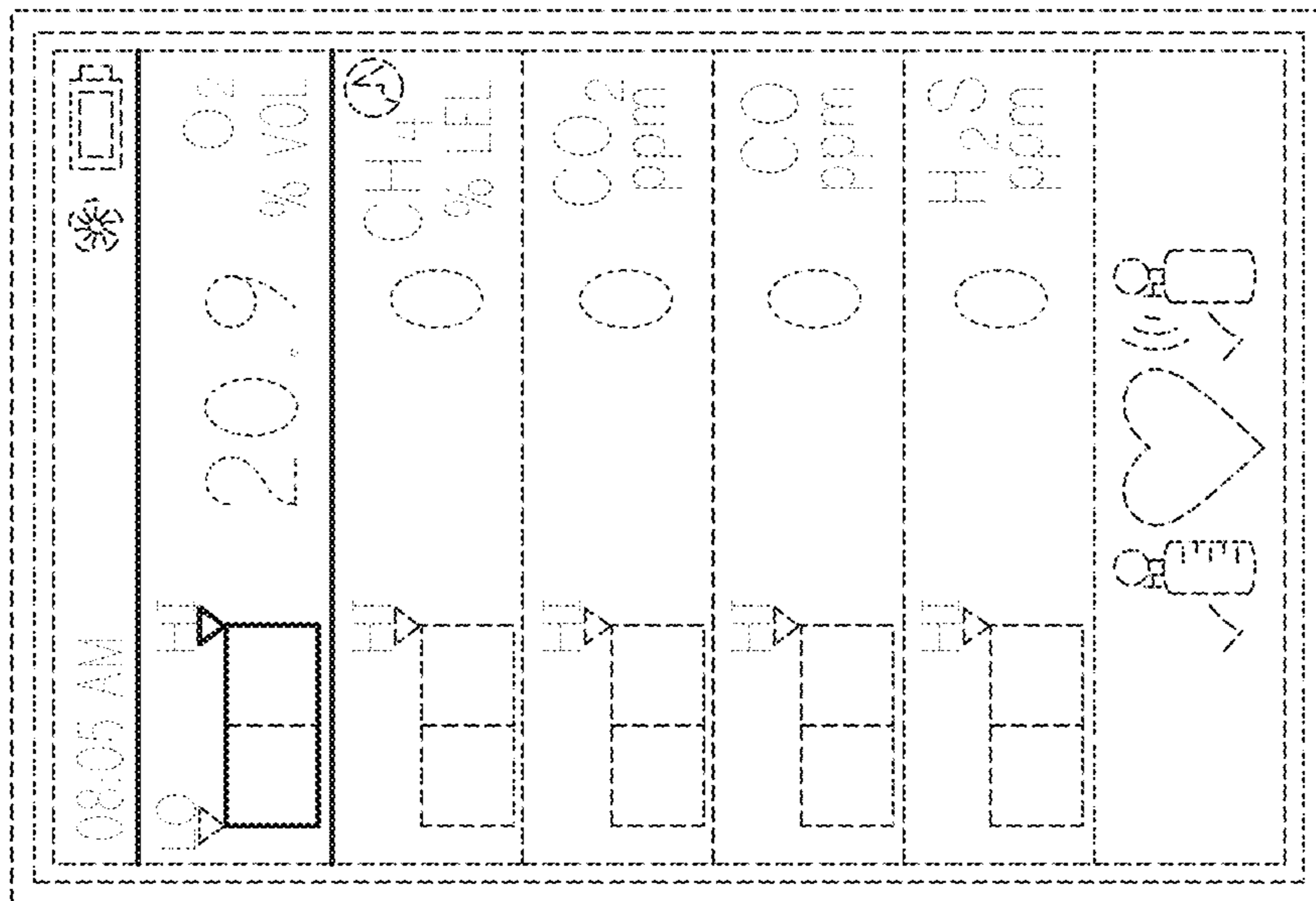

FIG. 4

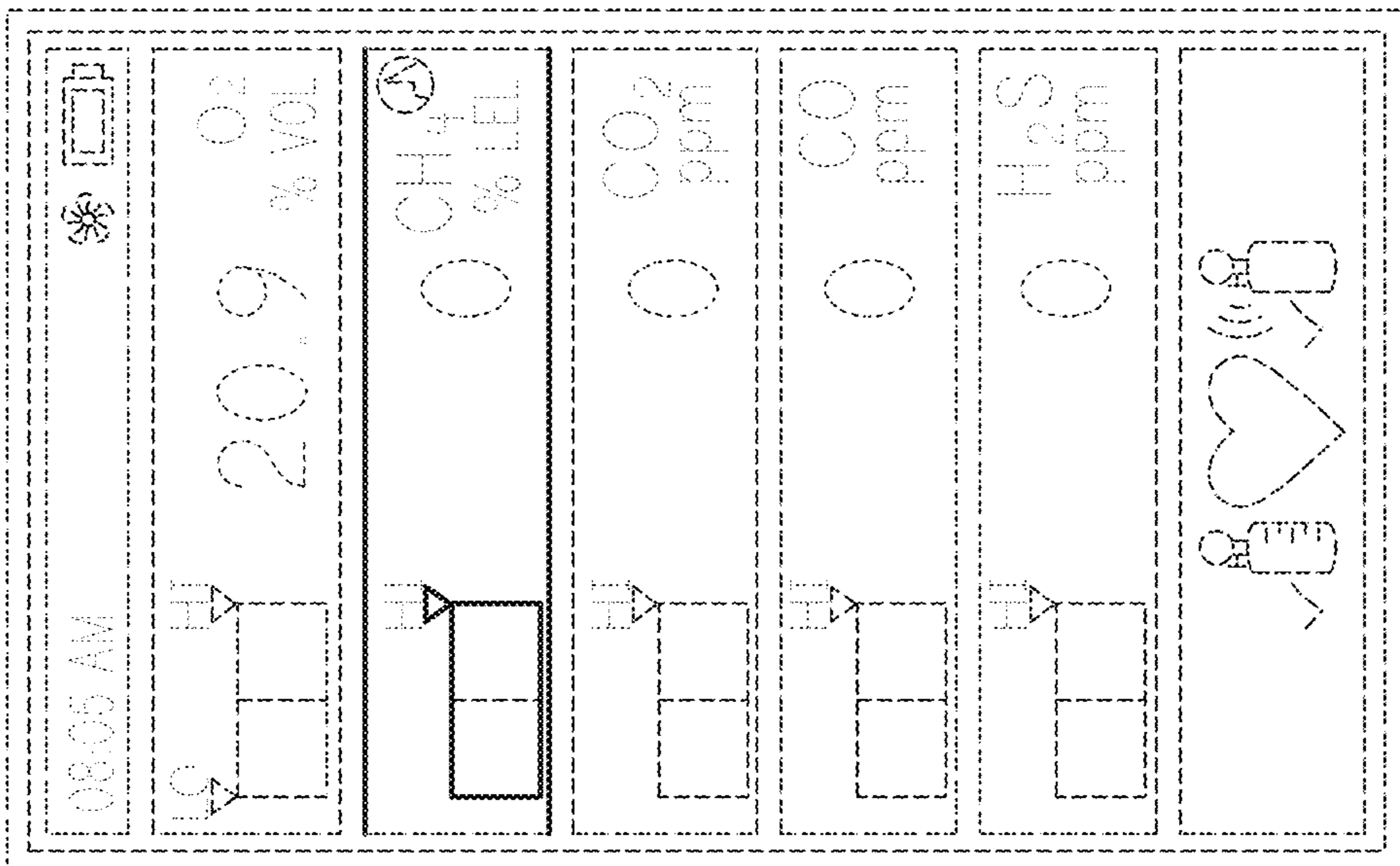

FIG. 5

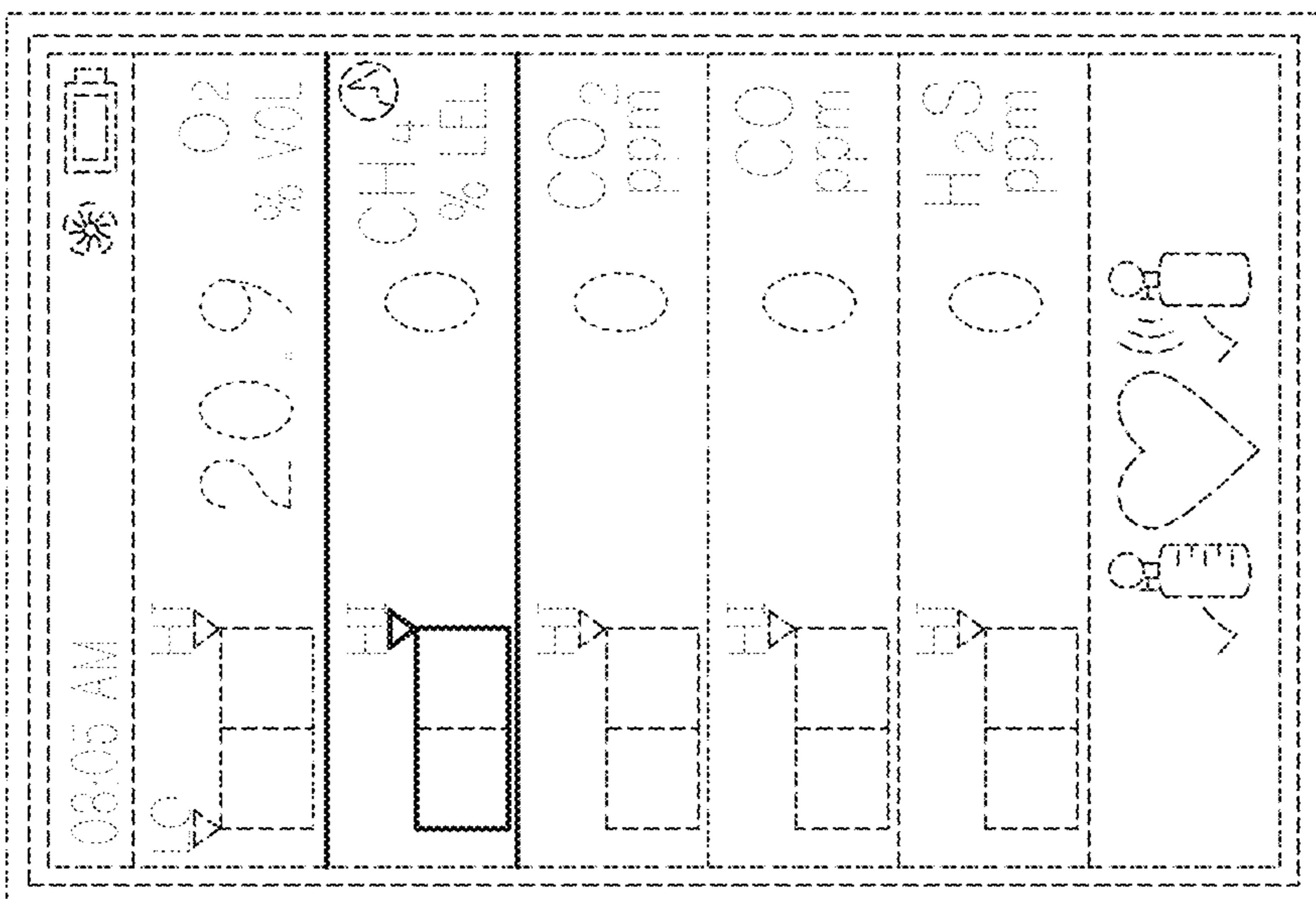

FIG. 6

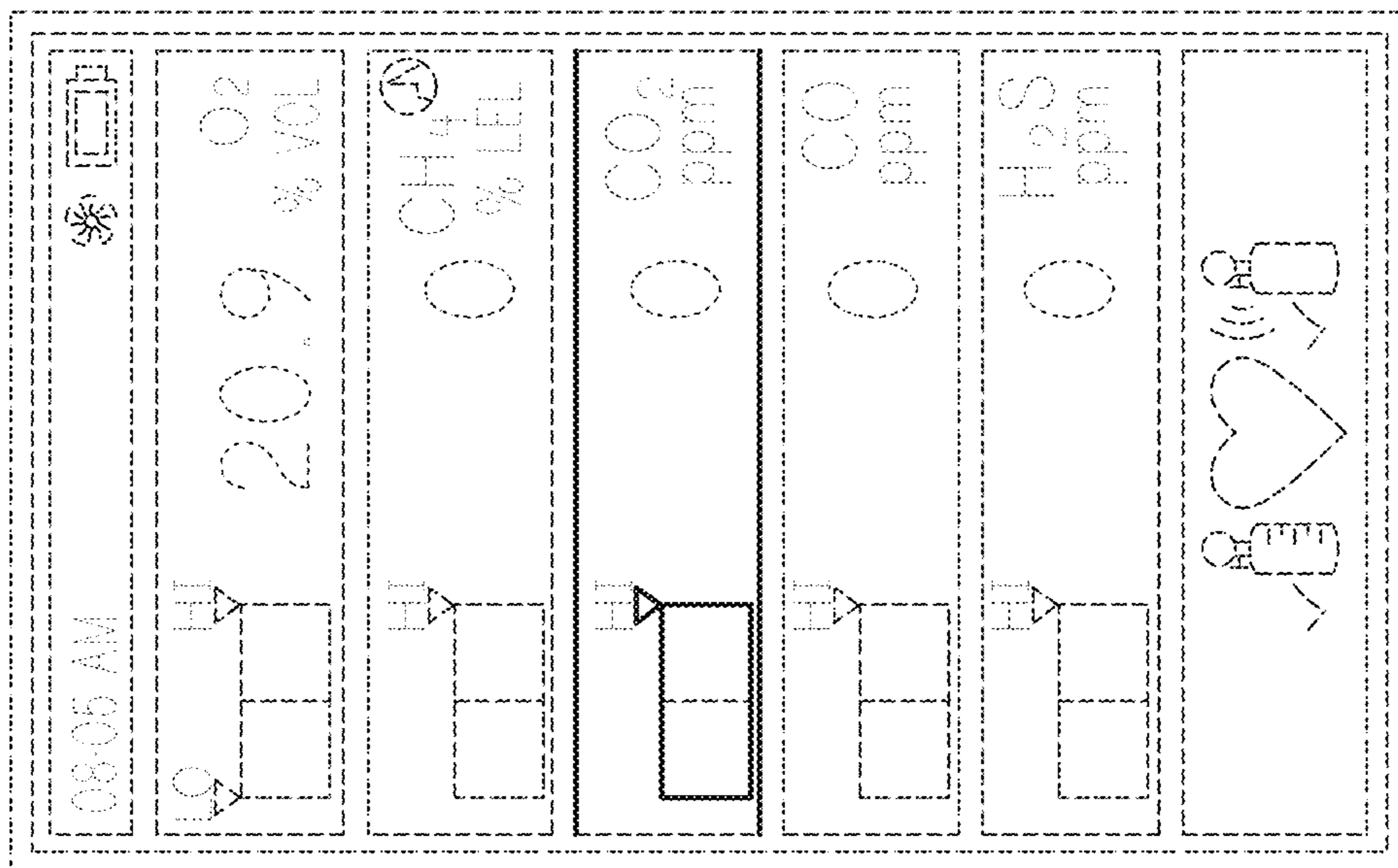

FIG. 8

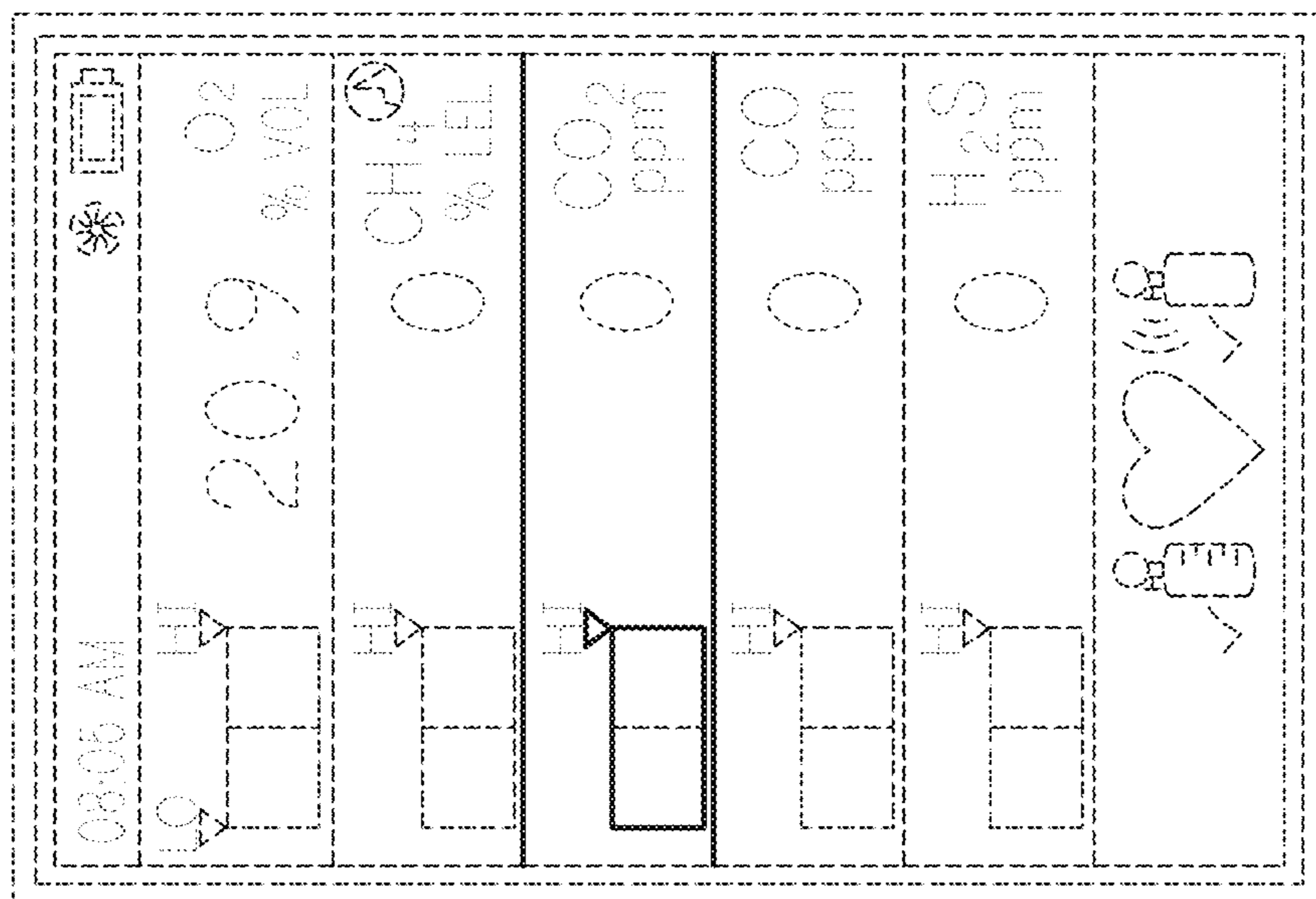

FIG. 7

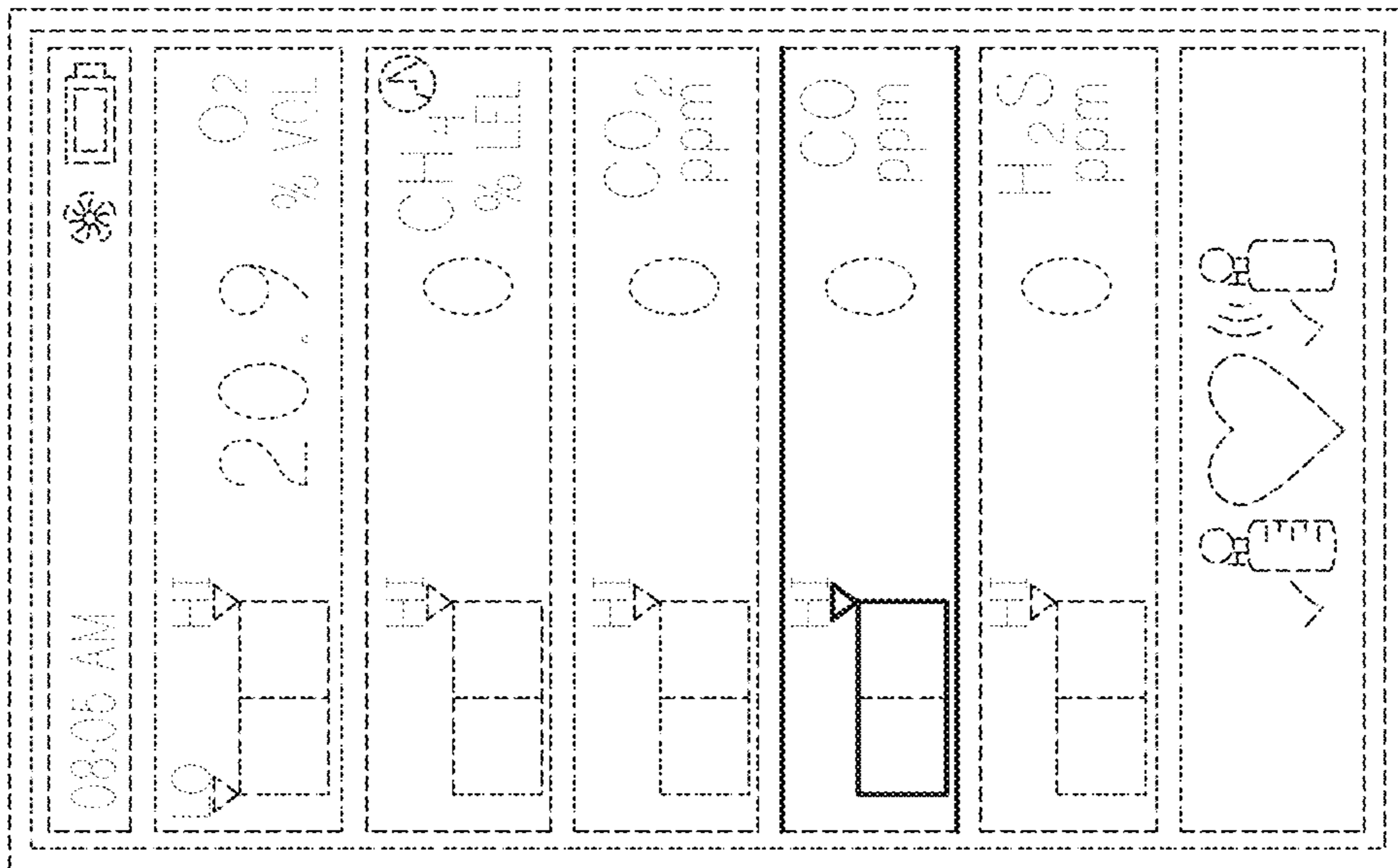

FIG. 9

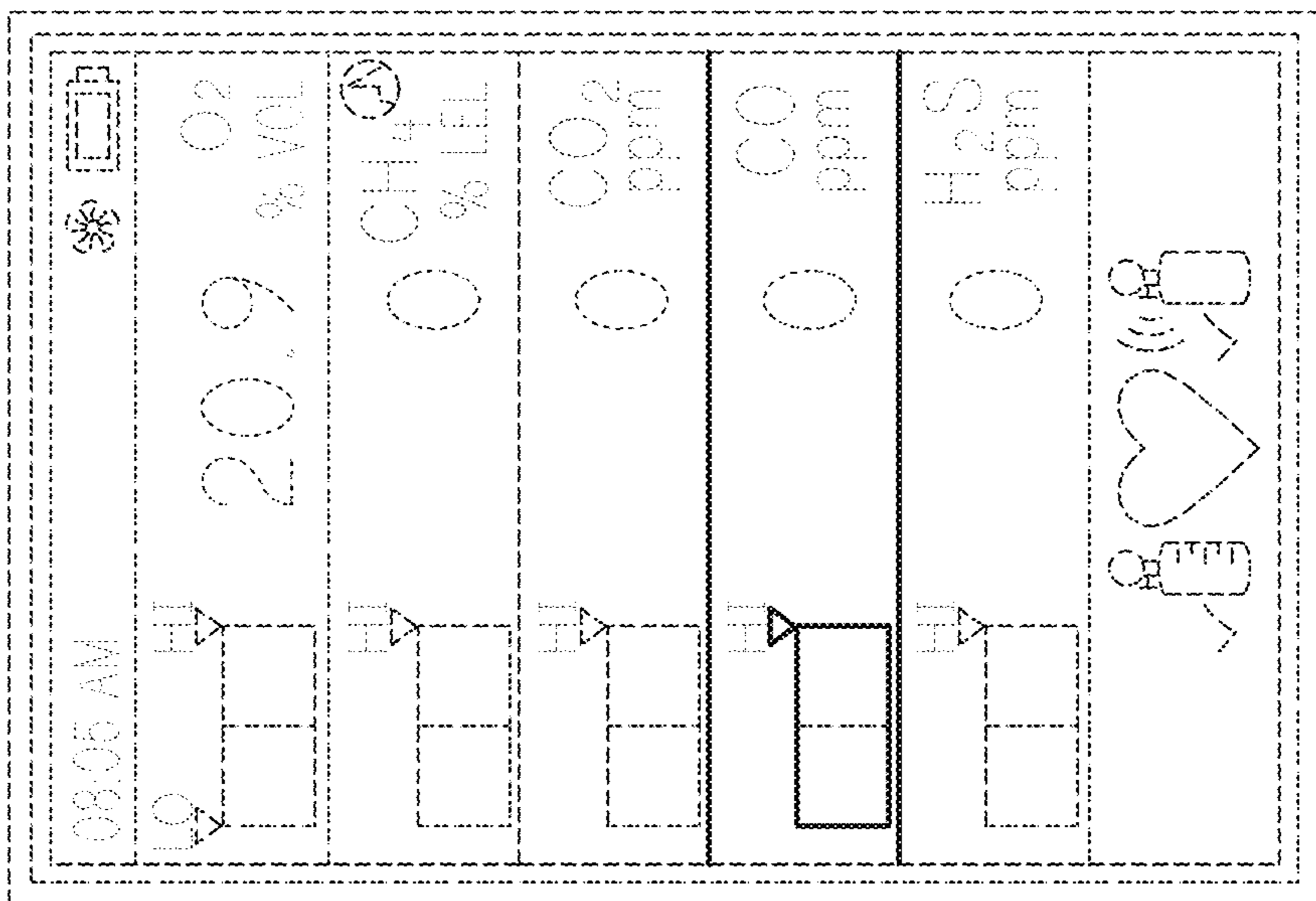

FIG. 10

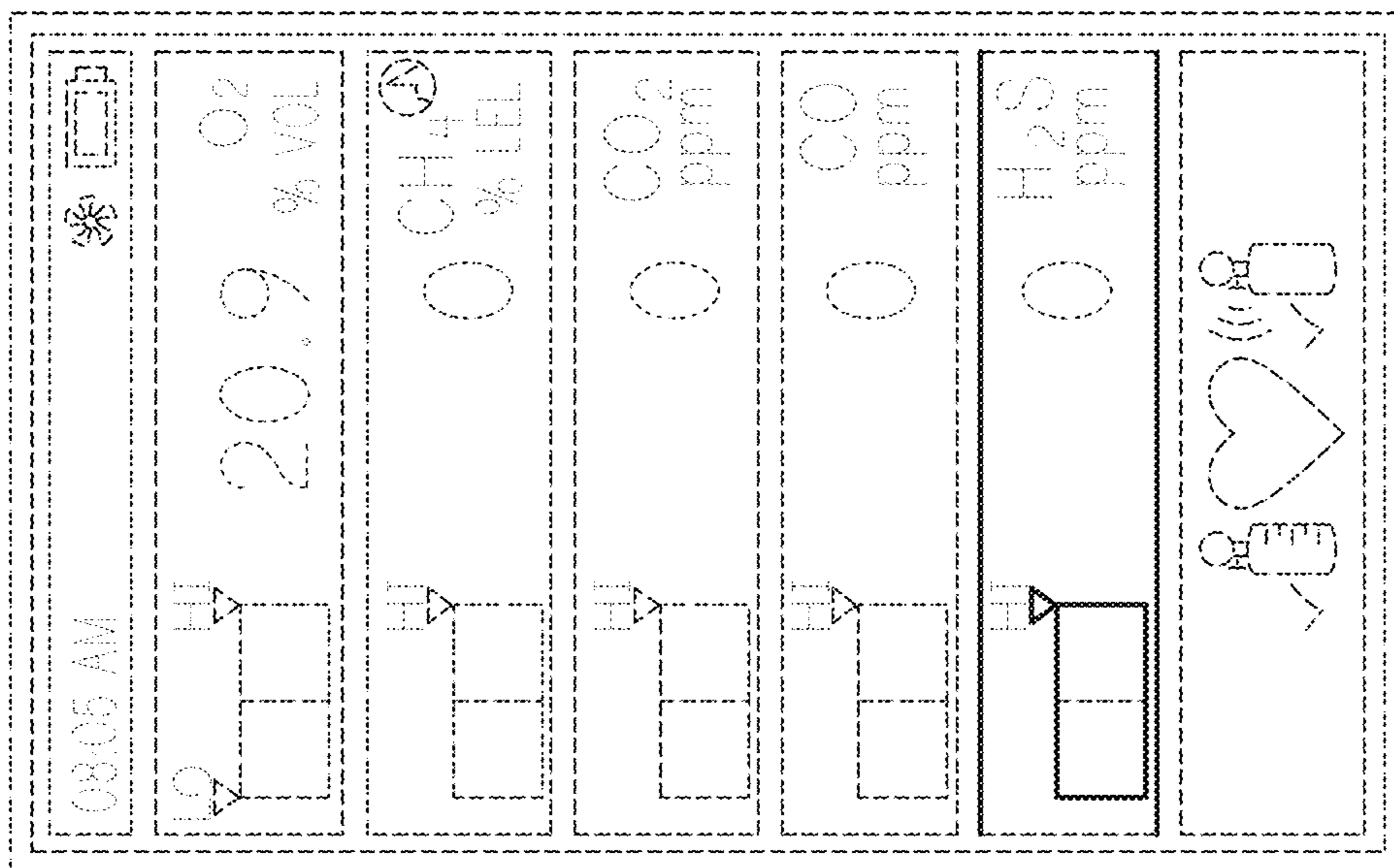

FIG. 11

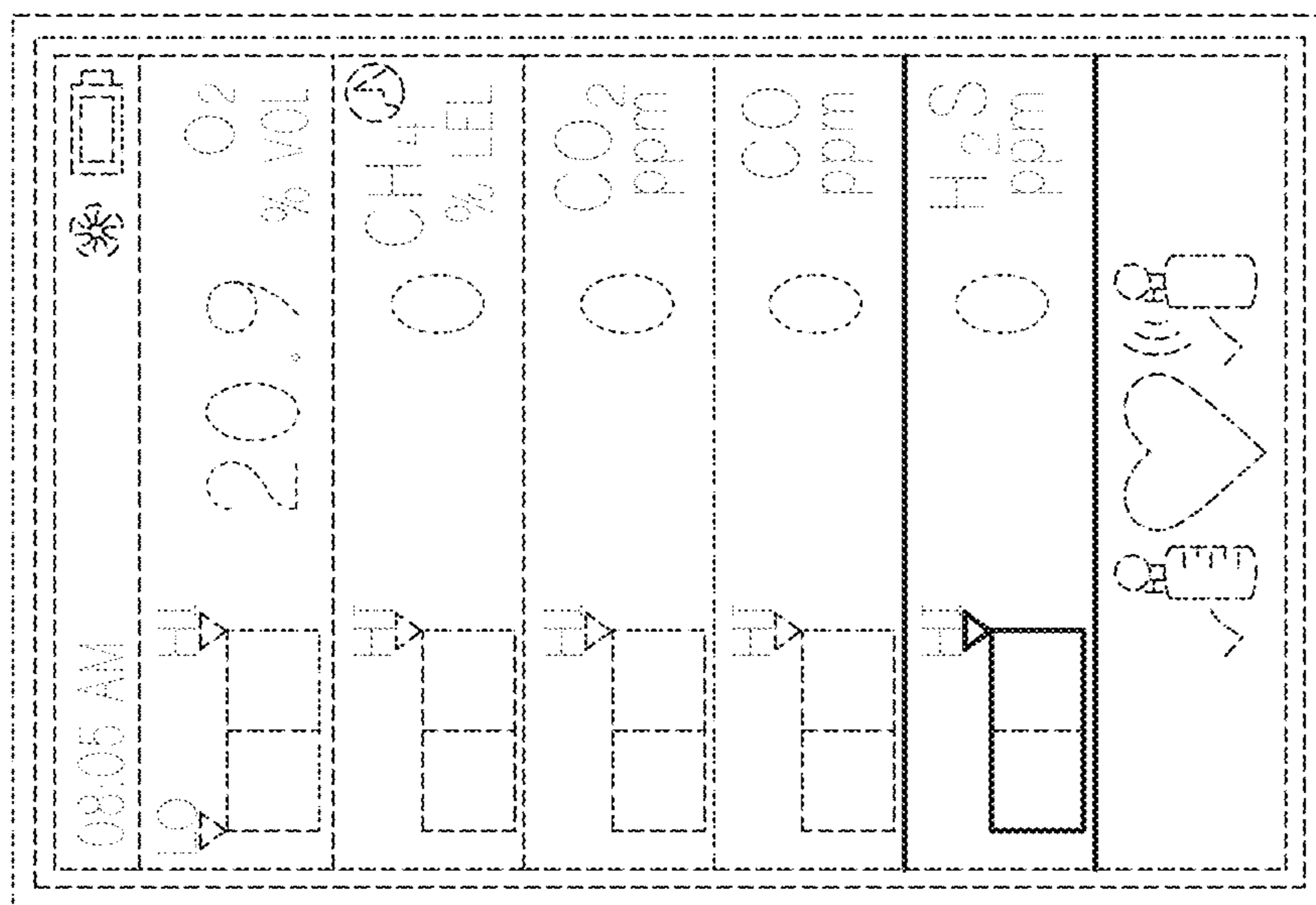

FIG. 12



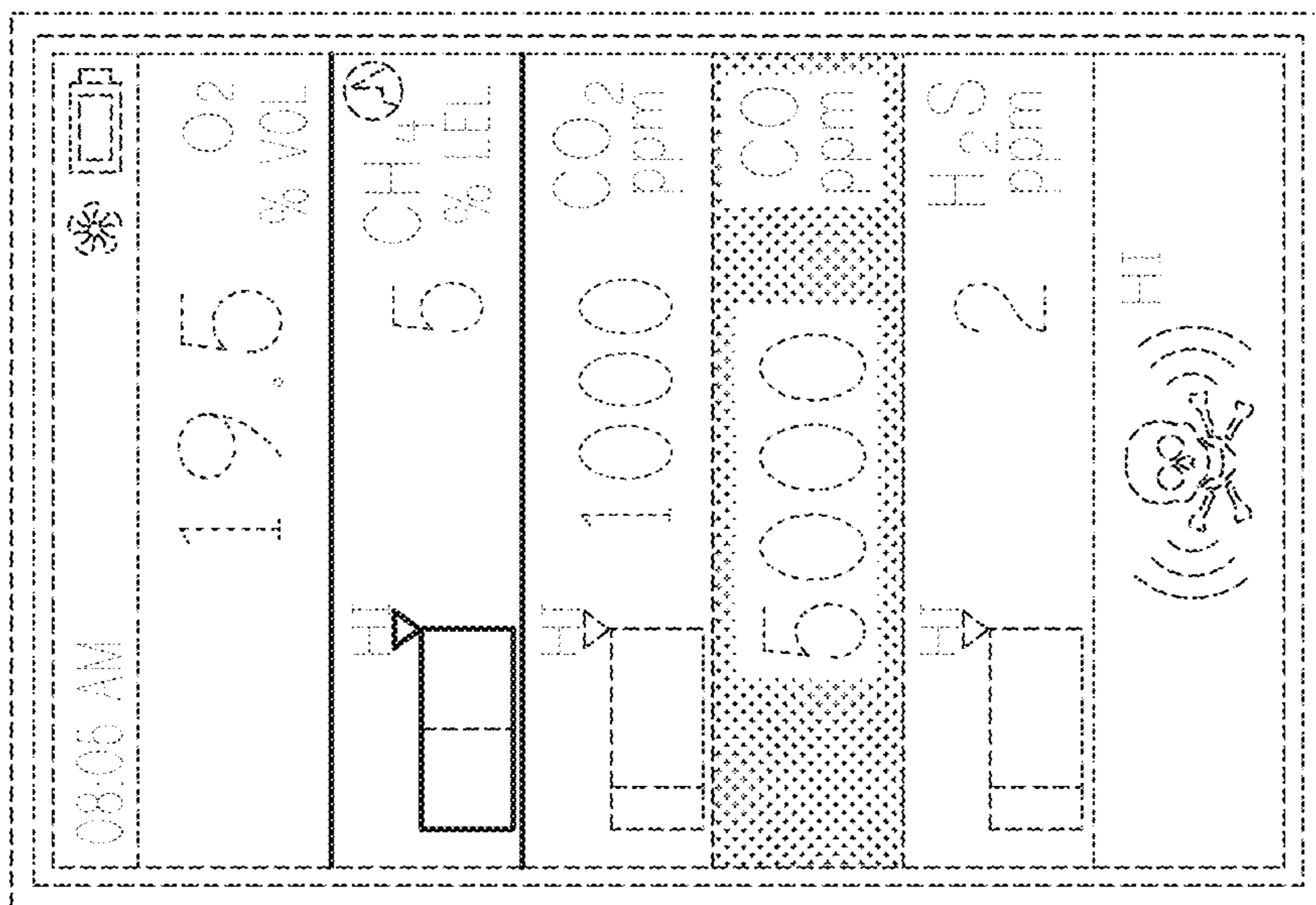

FIG. 13

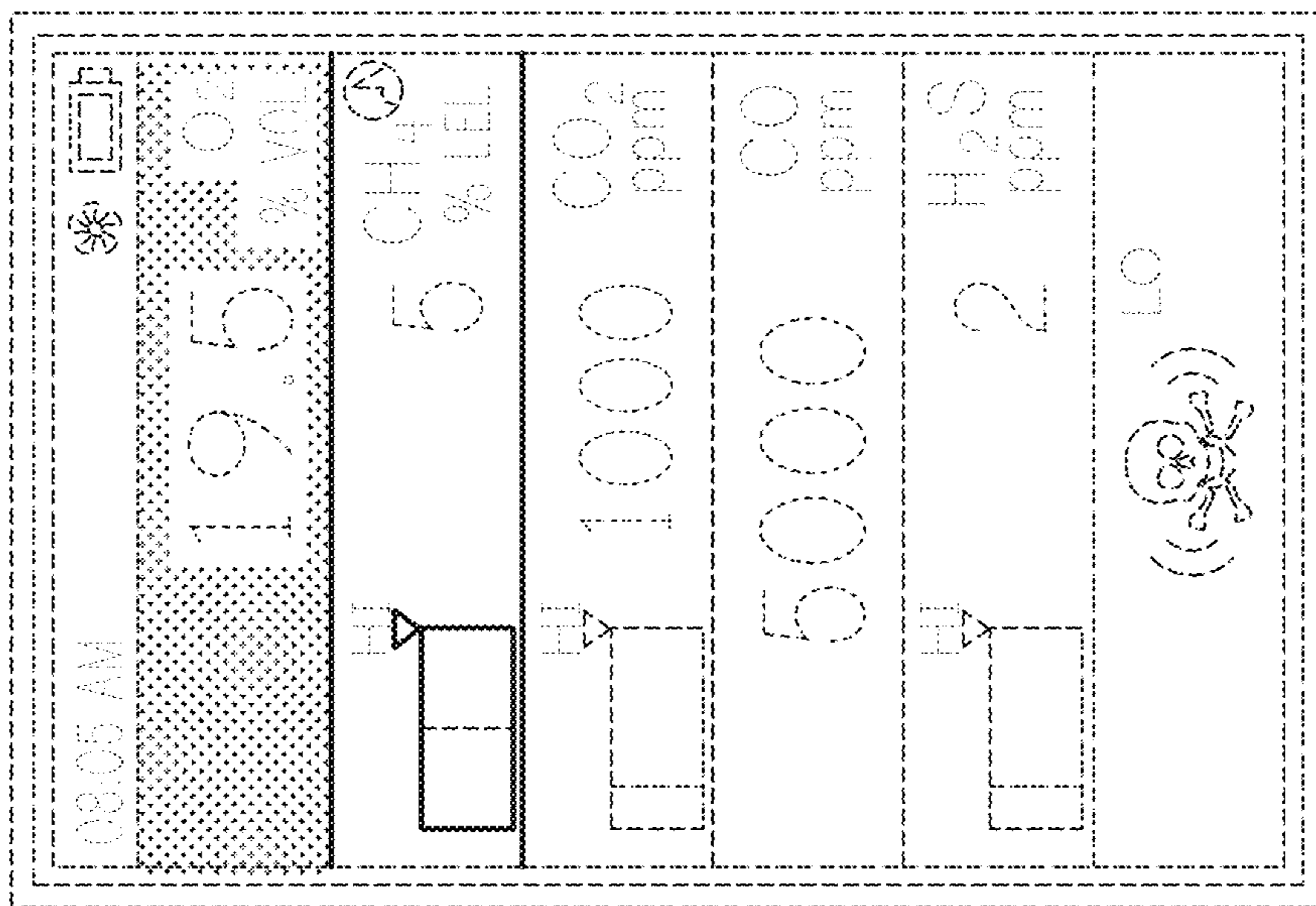

FIG. 14

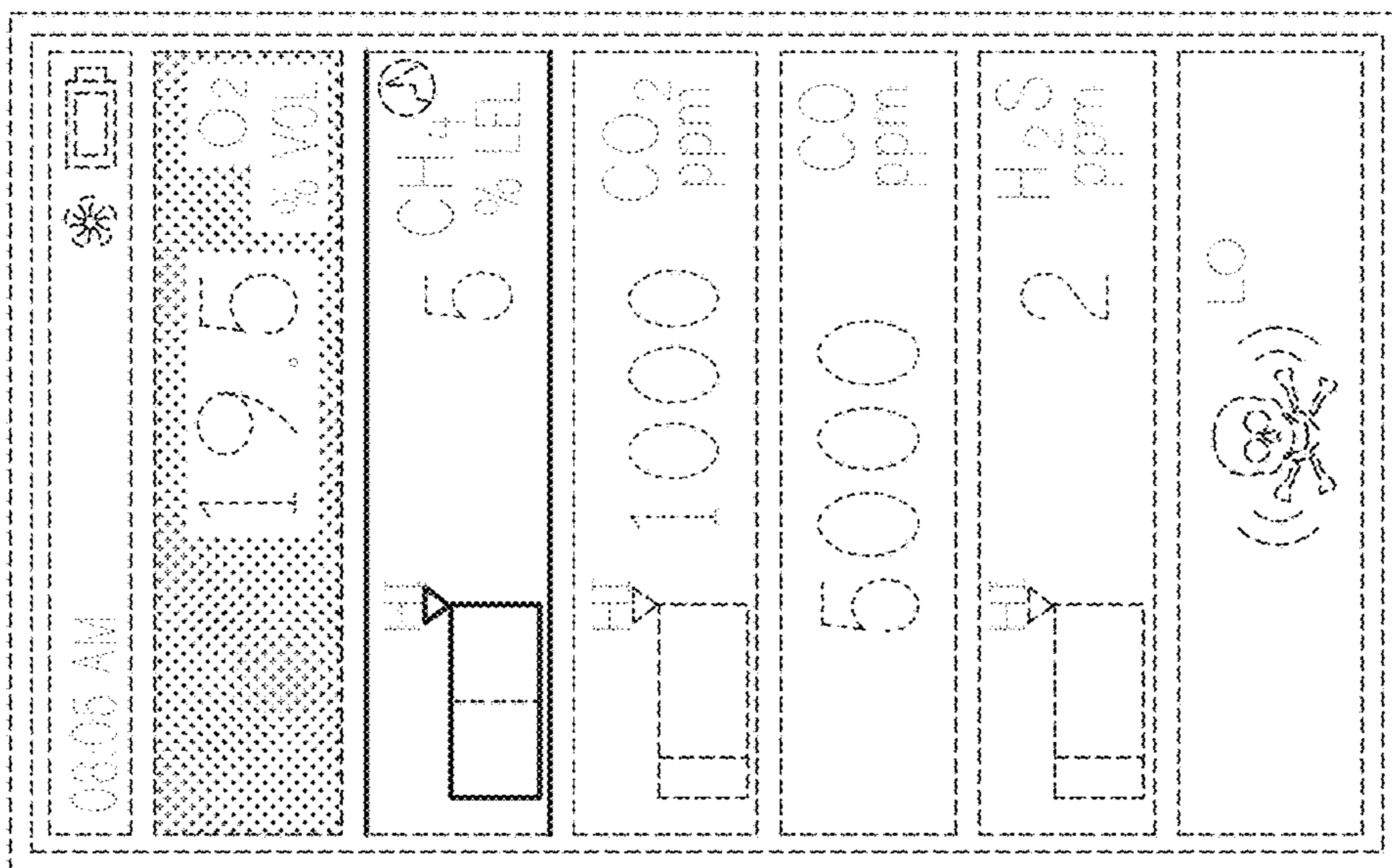

FIG. 15

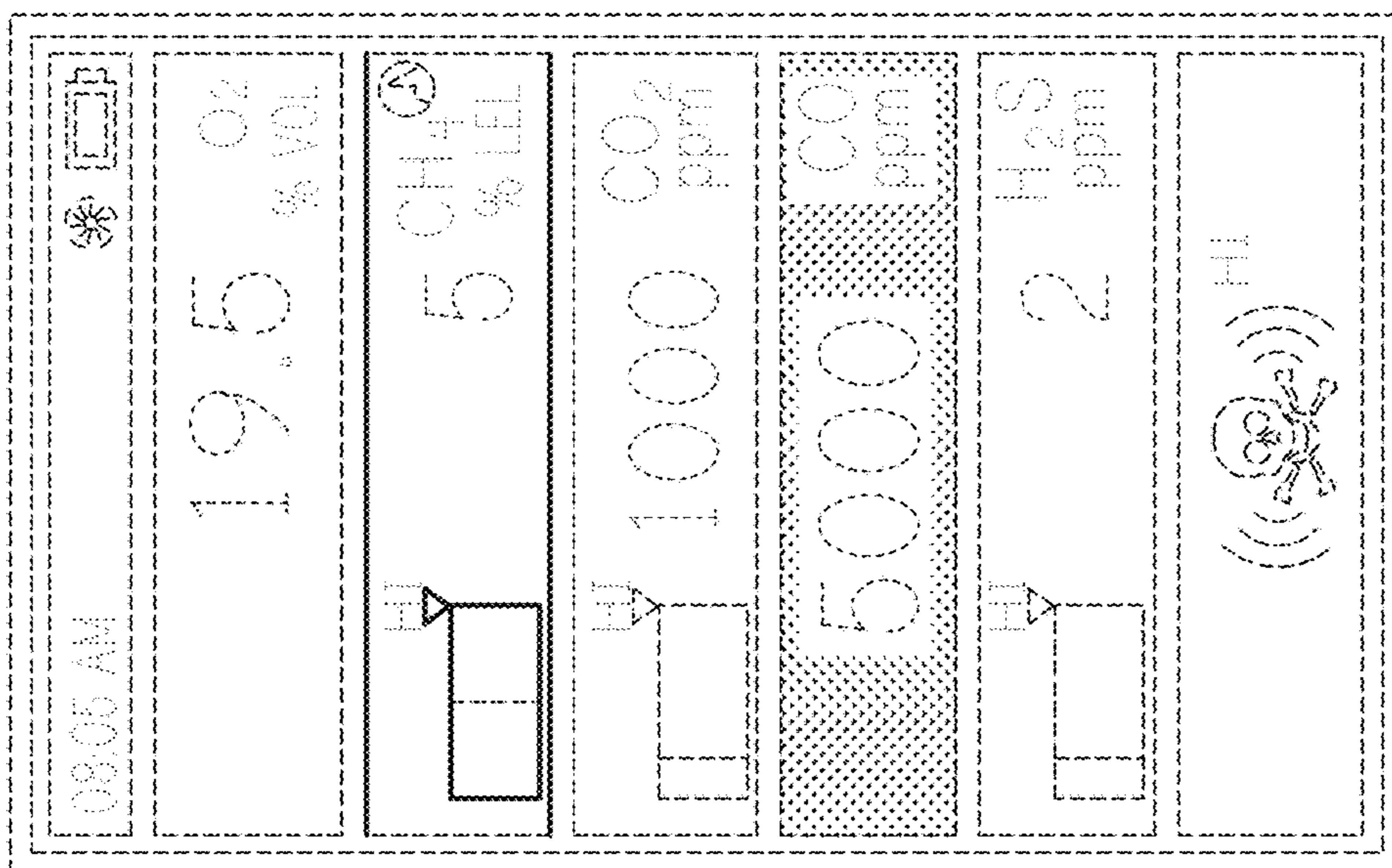

FIG. 16

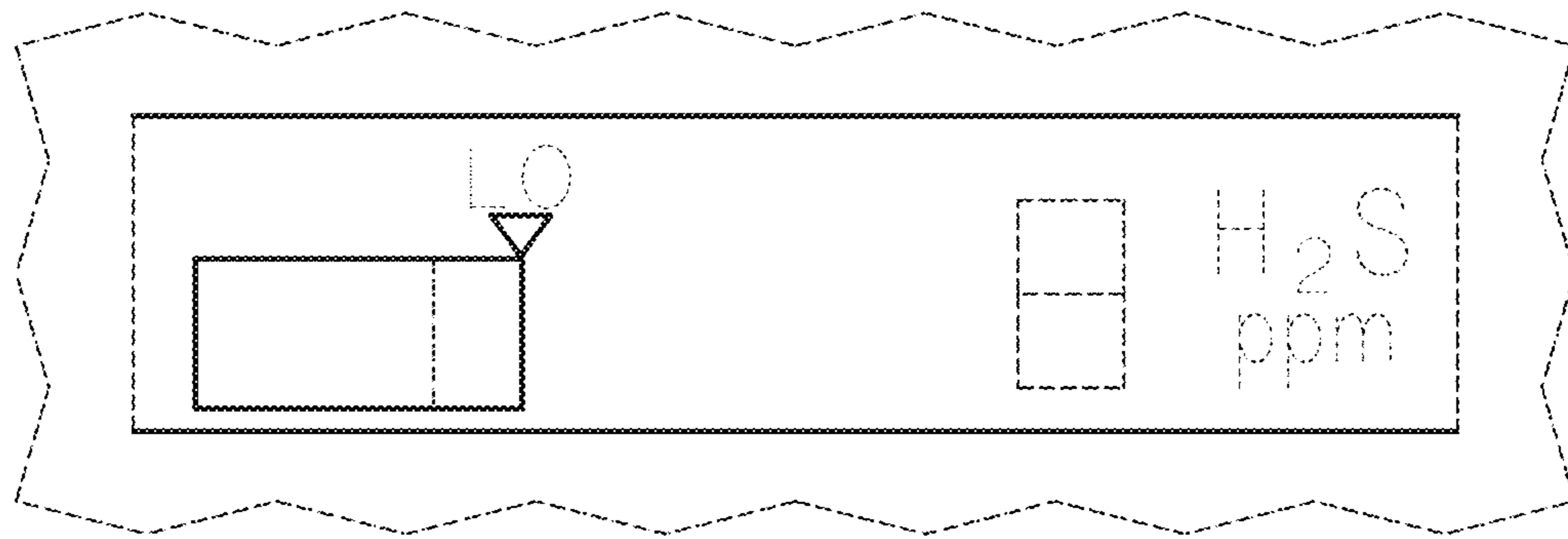

FIG. 17

UNITED STATES PATENT AND TRADEMARK OFFICE  
**CERTIFICATE OF CORRECTION**

PATENT NO. : D800,760 S  
APPLICATION NO. : 29/544088  
DATED : October 24, 2017  
INVENTOR(S) : Alejandra Gonzalez Delgado and Jacob Thomas Spector

Page 1 of 1

It is certified that error appears in the above-identified patent and that said Letters Patent is hereby corrected as shown below:

On the Title Page

Item (57) CLAIM, Line 1: “display screen or portion thereof with graphical user interface” should be “graphical user interface for a display screen or a portion thereof”

DESCRIPTION, Line 1: delete ““display screen or portion thereof with graphical user interface.”” and replace with “graphical user interface for a display screen or portion thereof showing our new design;”

Signed and Sealed this  
Twenty-sixth Day of December, 2017



Joseph Matal

*Performing the Functions and Duties of the  
Under Secretary of Commerce for Intellectual Property and  
Director of the United States Patent and Trademark Office*

UNITED STATES PATENT AND TRADEMARK OFFICE  
**CERTIFICATE OF CORRECTION**

PATENT NO. : D800,760 S  
APPLICATION NO. : 29/544088  
DATED : October 24, 2017  
INVENTOR(S) : Delgado et al.

Page 1 of 1

It is certified that error appears in the above-identified patent and that said Letters Patent is hereby corrected as shown below:

This certificate supersedes the Certificate of Correction issued December 26, 2017. The certificate was issued prematurely and is vacated since the Request for the Certificate of Correction dated November 29, 2017 was inappropriately granted. The correction to Claim 1, Line 1 should not have been granted since the applicant reversed an amendment that overcame an objection and it stands in the granted patent. The Certificate of Correction dated December 26, 2017, was published in error and should not have been issued for this patent.

Signed and Sealed this  
Fifth Day of June, 2018

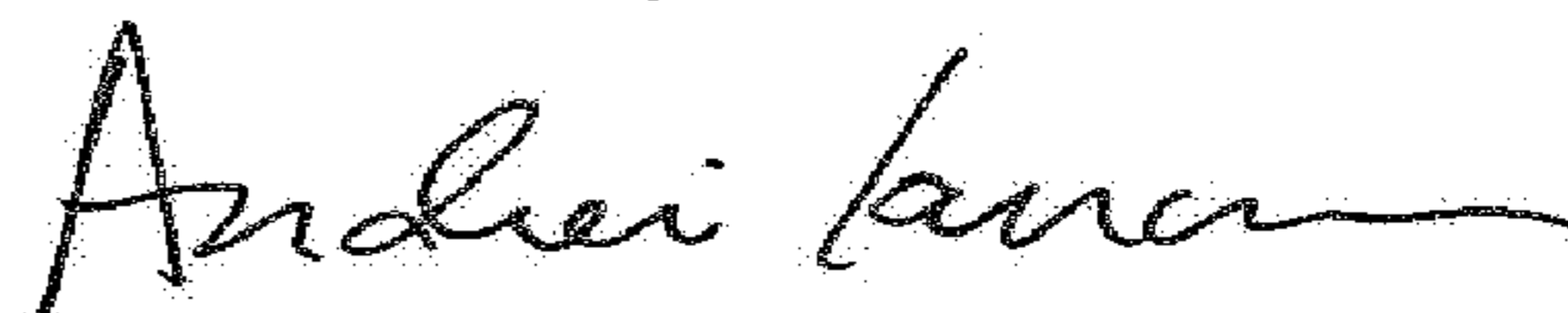

Andrei Iancu  
*Director of the United States Patent and Trademark Office*