



US00D800668S

(12) **United States Design Patent** (10) **Patent No.:** **US D800,668 S**  
**Lecoanet et al.** (45) **Date of Patent:** **\*\* Oct. 24, 2017**

(54) **ELECTRICAL CIRCUIT BREAKER**

(56) **References Cited**

(71) Applicant: **Schneider Electric Industries SAS**,  
Rueil-Malmaison (FR)

(72) Inventors: **Benoît Lecoanet**, Grenoble (FR);  
**Guillaume Reiner**, Grenoble (FR);  
**Gabriela Isabel Rubio Barraza**,  
Monterrey (MX); **Karla Morena**  
**Guajardo Gonzalez**, Monterrey (MX)

(73) Assignee: **SCHNEIDER ELECTRIC**  
**INDUSTRIES SAS**, Rueil-Malmaison  
(FR)

(\*\*) Term: **15 Years**

U.S. PATENT DOCUMENTS

D550,630 S \* 9/2007 Wang ..... D13/160  
D633,446 S \* 3/2011 Besana ..... D13/160  
7,924,136 B2 \* 4/2011 Darr ..... H01H 9/104  
337/143  
D765,607 S \* 9/2016 Stieger ..... D13/160  
2016/0285216 A1 \* 9/2016 Bury ..... H01R 9/26

\* cited by examiner

*Primary Examiner* — Daniel Bui

*Assistant Examiner* — Andrew Kerr

(74) *Attorney, Agent, or Firm* — Stephen J. Weyer, Esq.;  
Stites & Harbison, PLLC.

(21) Appl. No.: **29/505,579**

(57) **CLAIM**

(22) Filed: **Dec. 23, 2015**

The ornamental design for an electrical circuit breaker, as shown and described.

(30) **Foreign Application Priority Data**

Jun. 23, 2015 (WO) ..... 902260301

(51) **LOC (10) Cl.** ..... **13-03**

(52) **U.S. Cl.**  
USPC ..... **D13/160**

(58) **Field of Classification Search**  
USPC ..... D13/110, 112, 123, 133, 137.1, 137.3,  
D13/158–162, 173, 184, 199  
CPC .. H01H 3/22; H01H 9/02; H01H 9/54; H01H  
11/00; H01H 21/04; H01H 27/10; H01H  
33/38; H01H 71/00; H01H 71/02; H01H  
71/04; H01H 71/08; H01H 71/12; H01H  
71/24; H01F 17/04; H01R 25/00; H01R  
4/36

See application file for complete search history.

**DESCRIPTION**

FIG. 1 is a front, right and top perspective view of an electrical circuit breaker showing our new design;  
FIG. 2 is a right elevation view thereof;  
FIG. 3 is a left elevation view thereof;  
FIG. 4 is a top plan view thereof;  
FIG. 5 is a bottom plan view thereof;  
FIG. 6 is a rear elevation view thereof; and,  
FIG. 7 is a front elevation view thereof.  
The broken lines in the figure drawings are included for the purpose of illustrating unclaimed environment and form no part of the claimed design.

**1 Claim, 7 Drawing Sheets**

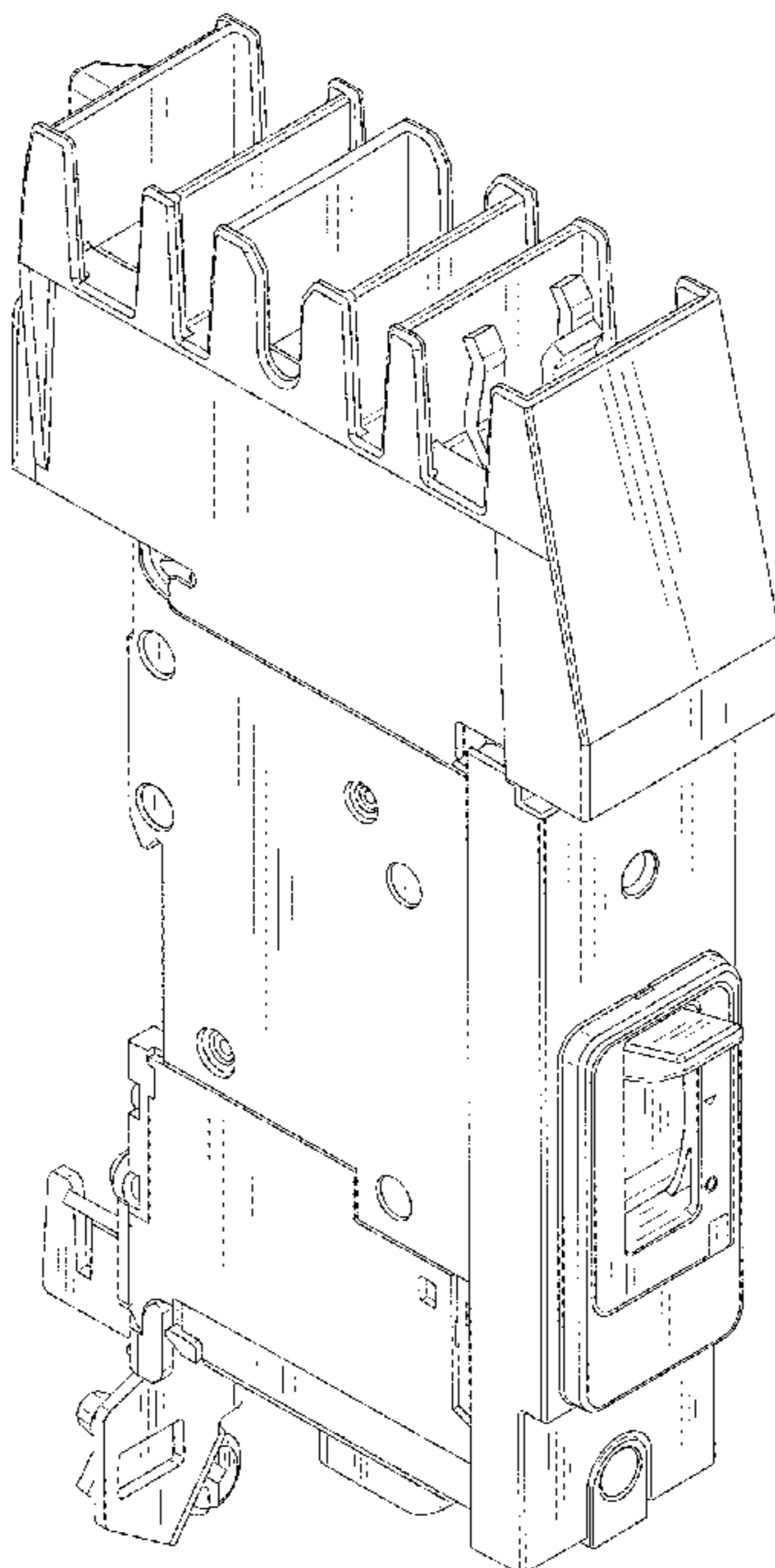

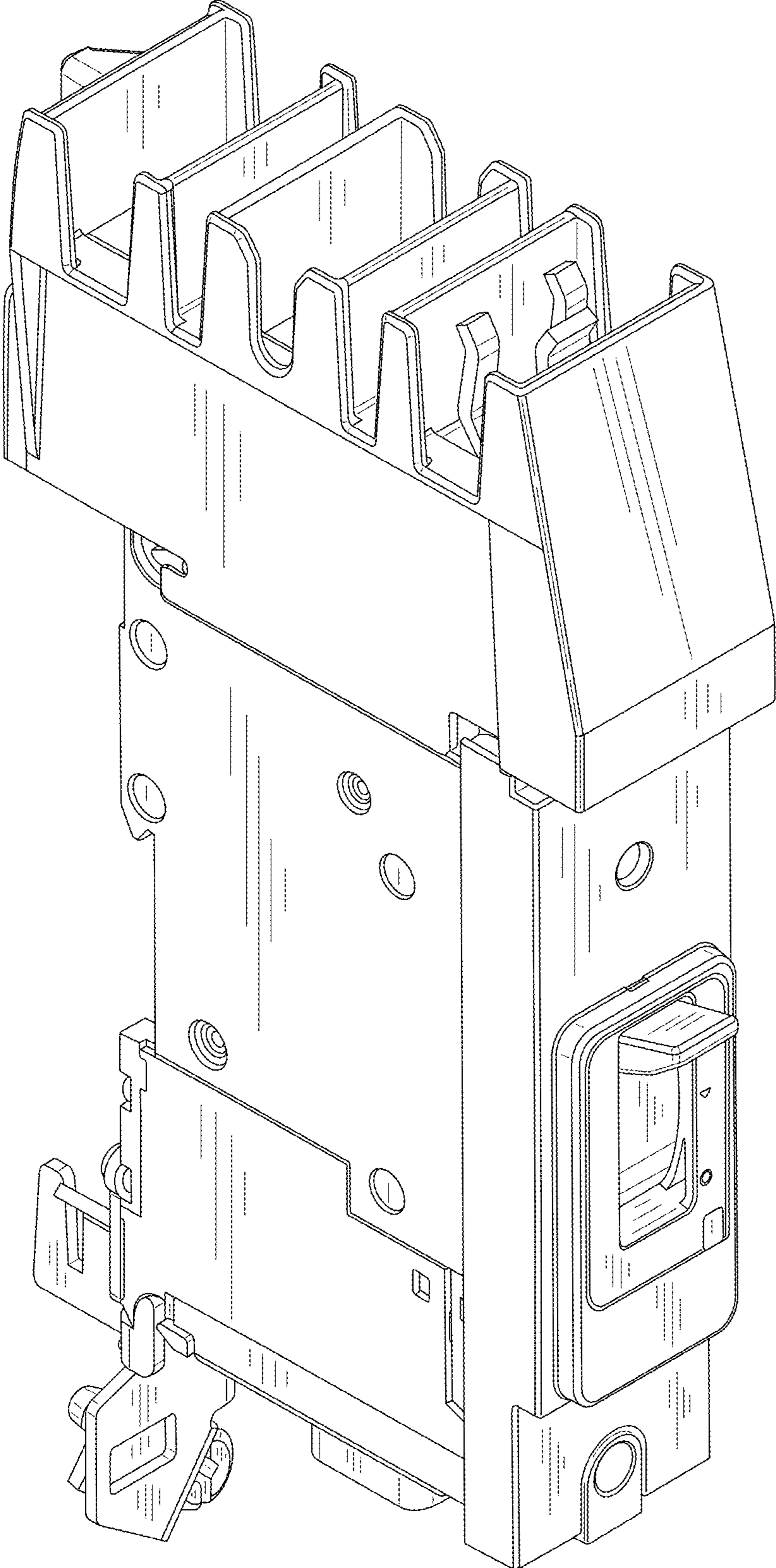

Fig. 1

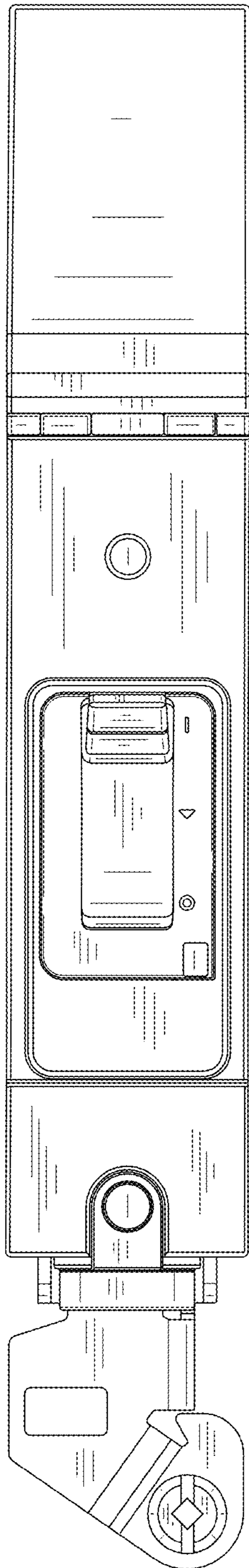

Fig. 2

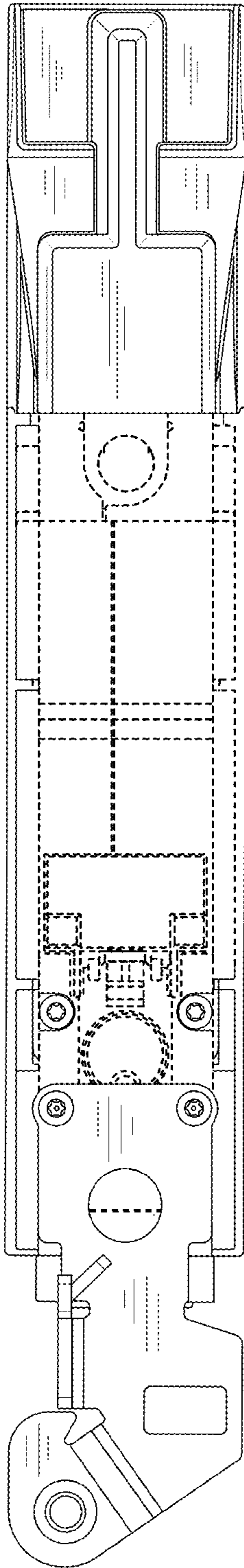

Fig. 3

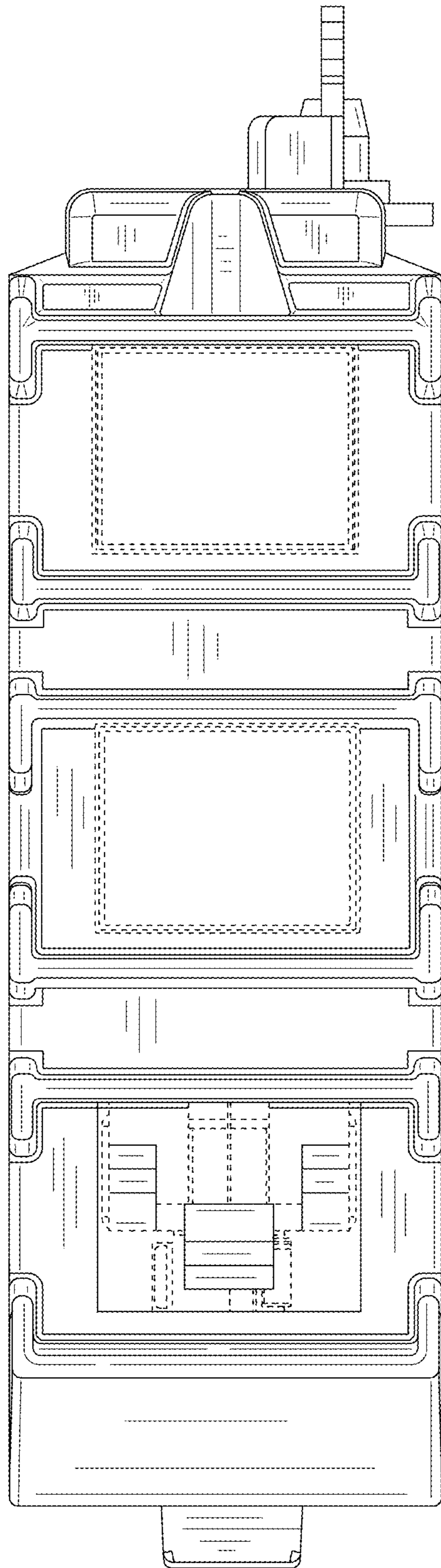

Fig. 4

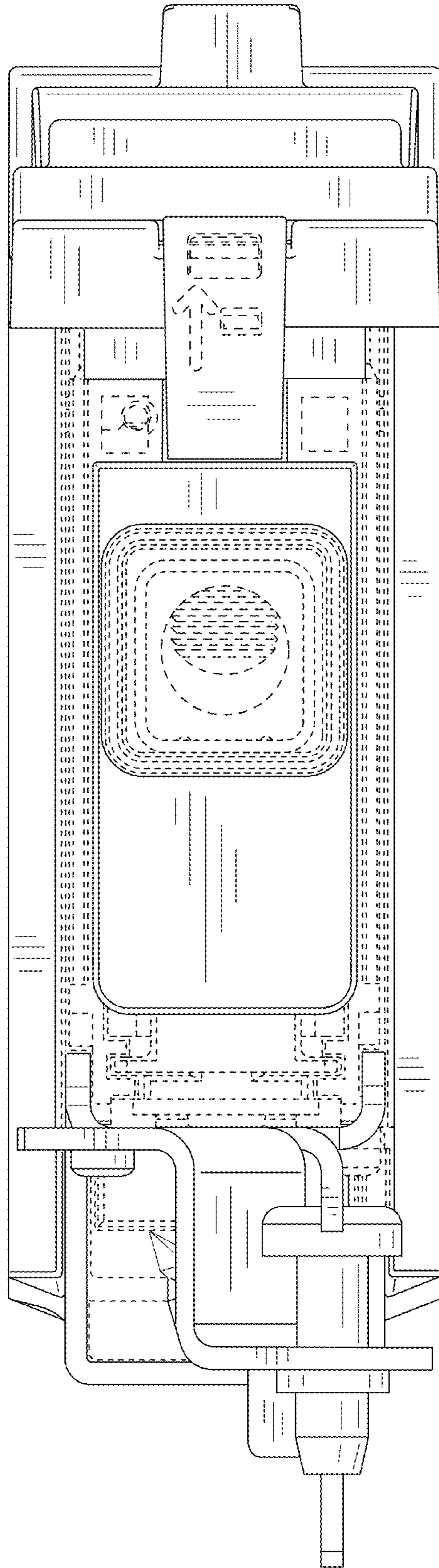

Fig. 5

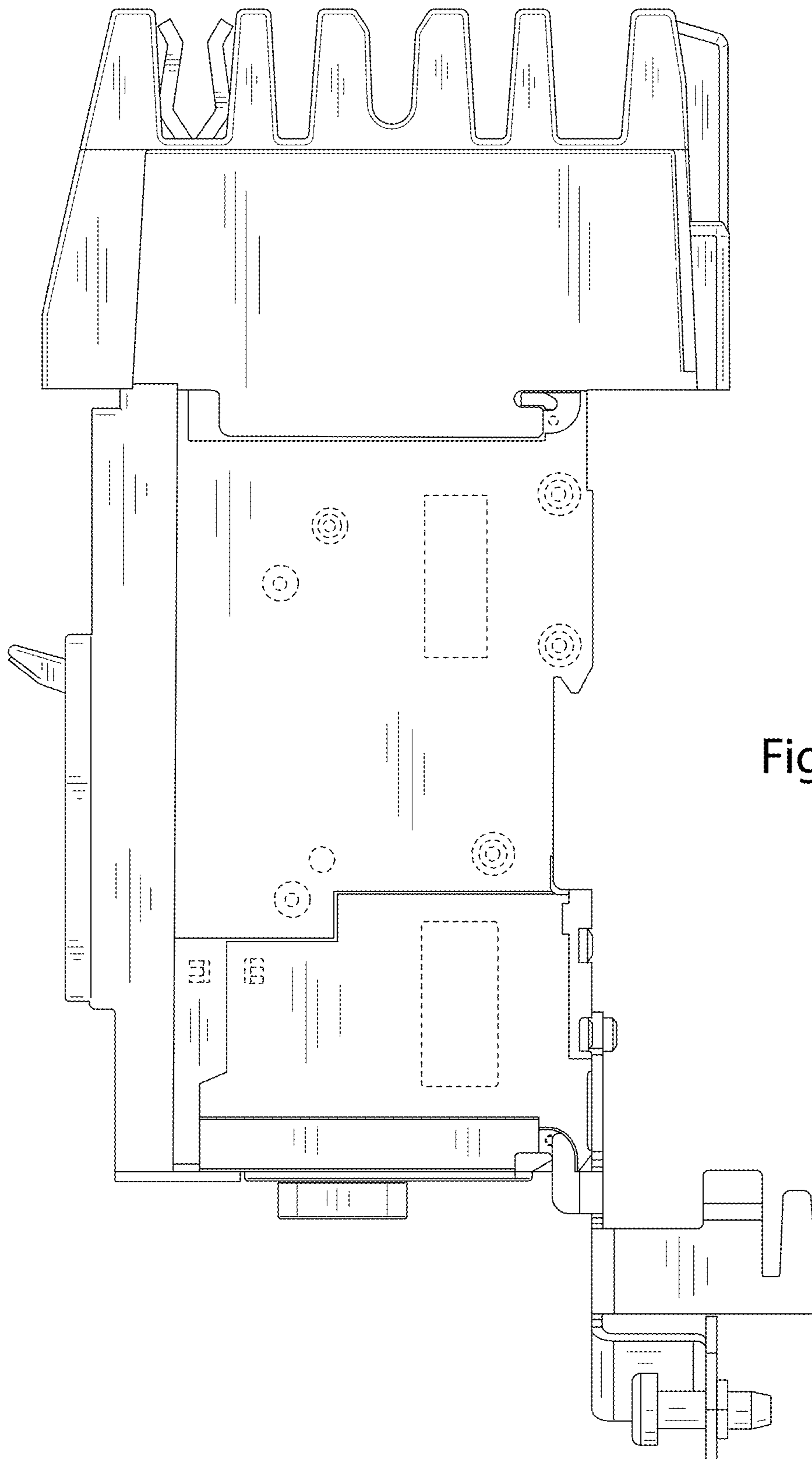

Fig. 6

