



US00D800621S

(12) **United States Design Patent** (10) **Patent No.:** **US D800,621 S**  
**Bucher et al.** (45) **Date of Patent:** **\*\* Oct. 24, 2017**

(54) **VEHICLE FRONT SKID PLATE**  
(71) Applicant: **Ford Global Technologies, LLC**,  
Dearborn, MI (US)  
(72) Inventors: **George Bucher**, Dearborn, MI (US);  
**Dean Carbis**, Bloomfield Hills, MI  
(US)  
(73) Assignee: **Ford Global Technologies, LLC**,  
Dearborn, MI (US)  
(\*\*) Term: **15 Years**  
(21) Appl. No.: **29/543,679**  
(22) Filed: **Oct. 27, 2015**  
(51) **LOC (10) Cl.** ..... **12-16**  
(52) **U.S. Cl.**  
USPC ..... **D12/196**  
(58) **Field of Classification Search**  
USPC ..... D12/14, 15, 16, 90, 91, 92, 107, 171,  
D12/190, 191, 196, 400, 169; D15/17,  
D15/23, 31; 296/57.1, 180.1, 180.2,  
296/181.1, 181.5; 293/113, 115, 117, 120  
CPC ..... B60R 19/12; B60K 11/08  
See application file for complete search history.

D690,639 S \* 10/2013 Messale ..... D12/196  
D714,186 S \* 9/2014 Wu ..... D12/14  
D717,221 S \* 11/2014 Borkert ..... D12/181  
8,911,007 B2 \* 12/2014 Hirose ..... B60K 11/08  
293/115  
D734,230 S \* 7/2015 Wheel ..... D12/196  
D739,321 S \* 9/2015 Blanski ..... D12/169  
D747,242 S \* 1/2016 Frascella ..... D12/169  
D749,468 S \* 2/2016 Frascella ..... D12/169  
D754,041 S \* 4/2016 Behmer ..... D12/169  
D769,163 S \* 10/2016 Platto ..... D12/196  
D771,534 S \* 11/2016 Bucher ..... D12/169

(Continued)

**OTHER PUBLICATIONS**

Bob Nagy <http://www.kbb.com/car-news/all-the-latest/2017-Ford-escape-spied/2000012056> 2017 Ford Escape spied, dated May 15, 2015.

(Continued)

*Primary Examiner* — Derrick Holland  
*Assistant Examiner* — Yolanda Robinson  
(74) *Attorney, Agent, or Firm* — Damian Porcari

(57) **CLAIM**

The ornamental design for a vehicle front skid plate, as shown and described.

**DESCRIPTION**

FIG. 1 is a bottom front perspective and left view of the vehicle front skid plate;  
FIG. 2 is a bottom front perspective and right view thereof;  
FIG. 3 is a top rear perspective view thereof;  
FIG. 4 is a front elevational view thereof;  
FIG. 5 is a rear elevational view thereof;  
FIG. 6 is a left side elevational view thereof;  
FIG. 7 is a right side elevational view thereof;  
FIG. 8 is a top plan view thereof; and,  
FIG. 9 is a bottom plan view thereof.

**1 Claim, 9 Drawing Sheets**

(56) **References Cited**  
U.S. PATENT DOCUMENTS  
D474,726 S \* 5/2003 Weber ..... D12/14  
D476,934 S \* 7/2003 Murkett ..... D12/196  
D511,715 S \* 11/2005 Hohnl ..... D12/14  
D515,971 S \* 2/2006 Essig ..... D12/16  
D525,575 S \* 7/2006 Matei ..... D12/164  
D556,663 S \* 12/2007 Murkett ..... D12/164  
D580,319 S \* 11/2008 Gueler ..... D12/169  
D605,977 S \* 12/2009 Zipfel ..... D12/91  
D616,797 S \* 6/2010 Lamm ..... D12/196  
D647,445 S \* 10/2011 Tonello ..... D12/196  
D685,005 S \* 6/2013 Dwyer ..... D15/17

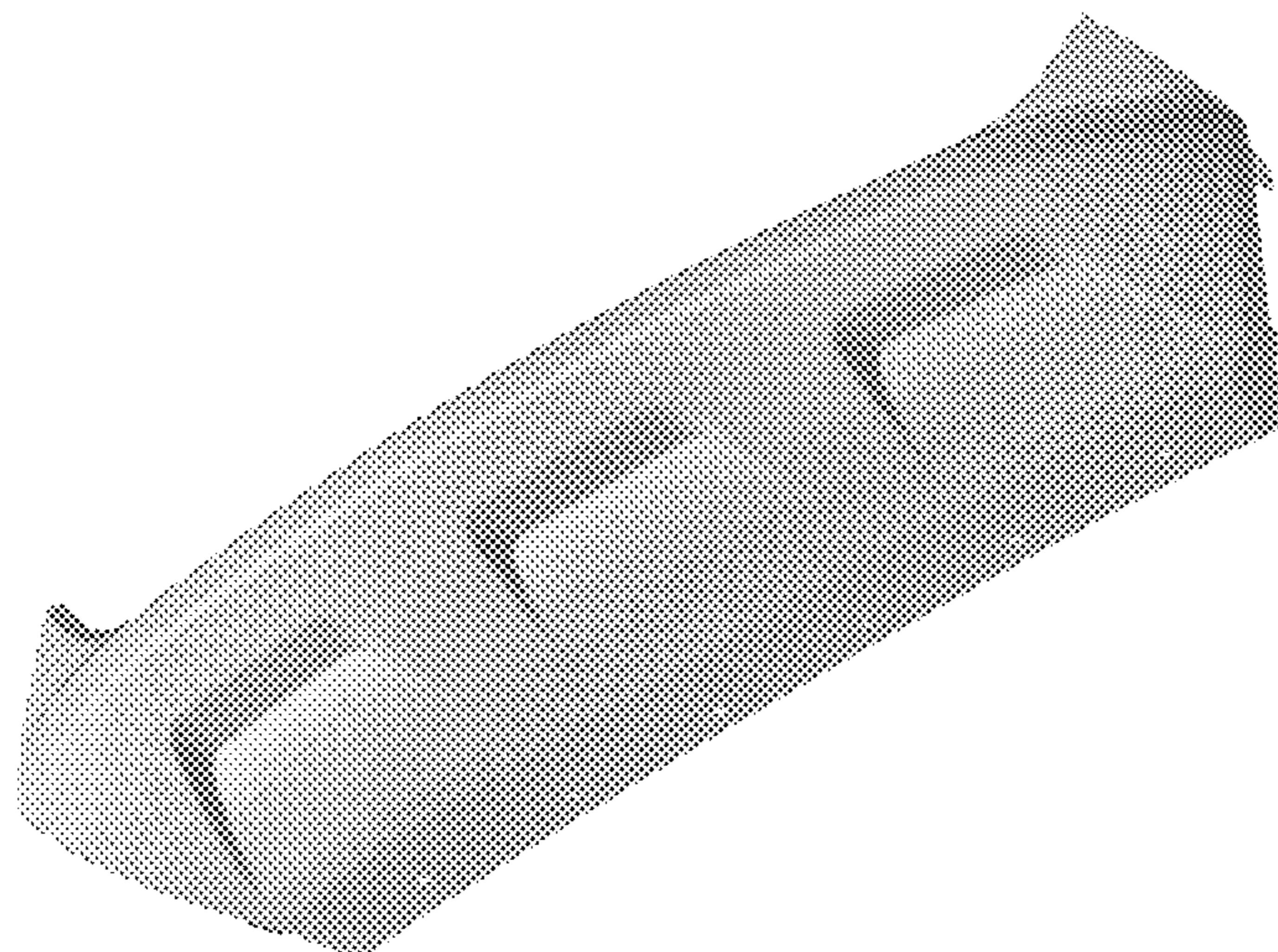

(56)

**References Cited**

U.S. PATENT DOCUMENTS

D779,403 S \* 2/2017 Orlando ..... D12/190  
D787,989 S \* 5/2017 Kozub ..... D12/169  
2012/0153643 A1\* 6/2012 Mana ..... B60R 19/12  
293/120

OTHER PUBLICATIONS

Mark McNabb <http://www.topspeed.com/trucks/truck-reviews/Ford/2017-Ford-escape-ar169435.html> 2017 Ford Escape dated May 18, 2015.

Alexander Stoklosa <http://www.caranddriver/news/2017-Ford-escape-spy-photos-news> 2017 Ford Escape Spy Photos dated May 2015.

Unknown <http://www.autoblog.com/2015/06/25/2017/Ford-escape-spy-shots> New Ford Escape spied inside and out dated Jun. 25, 2015.

\* cited by examiner

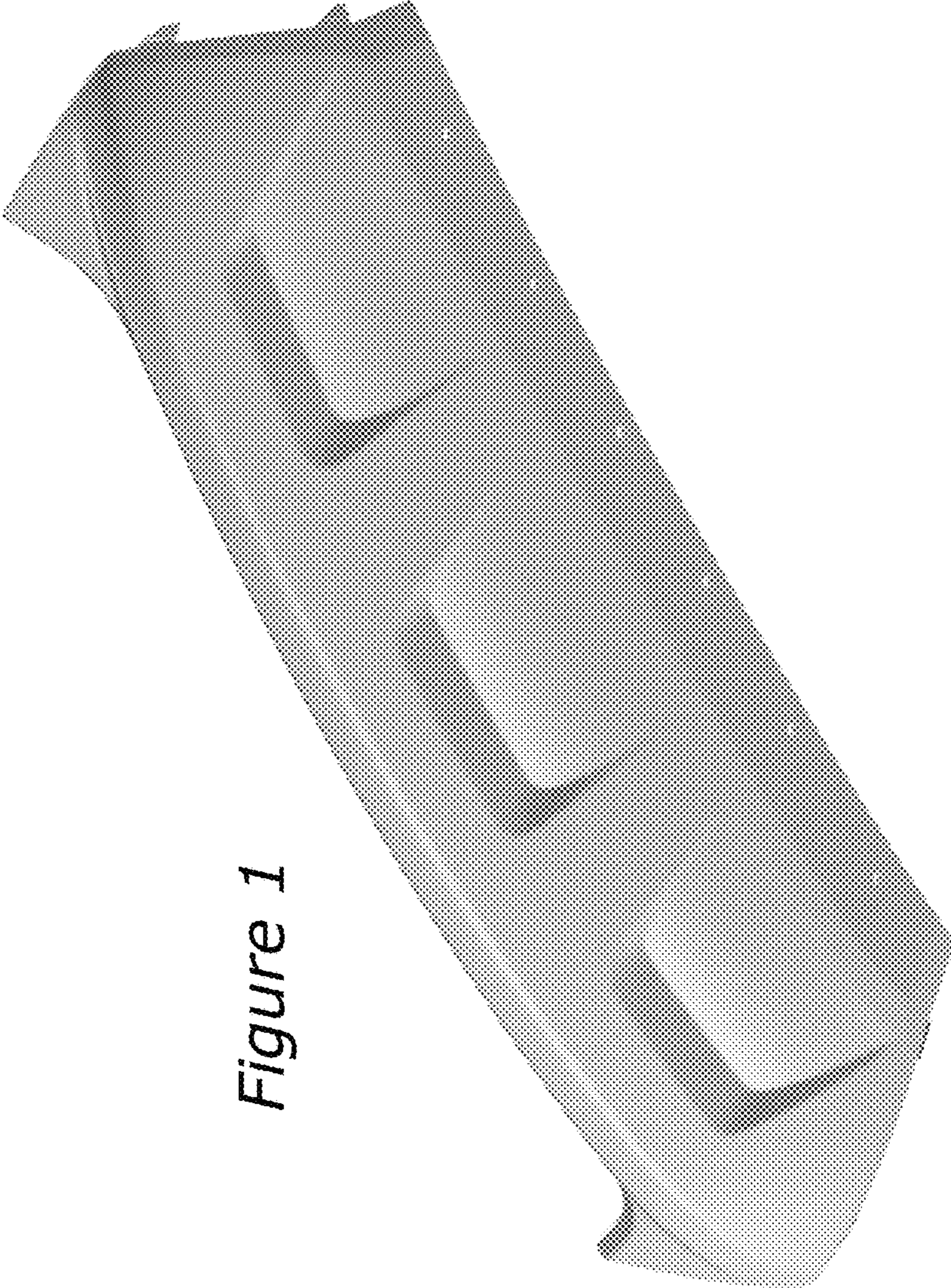

Figure 1

Figure 2



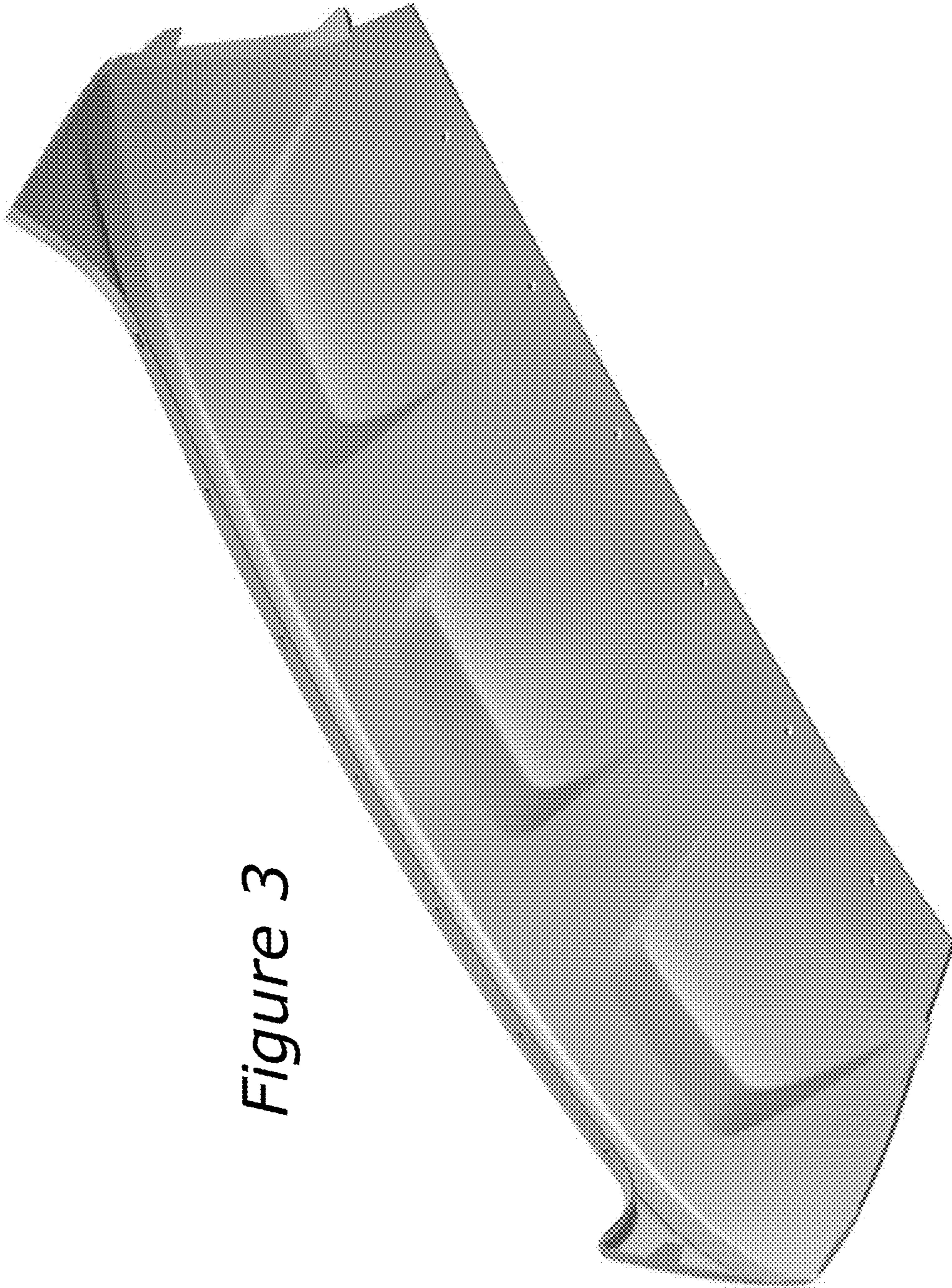

Figure 3

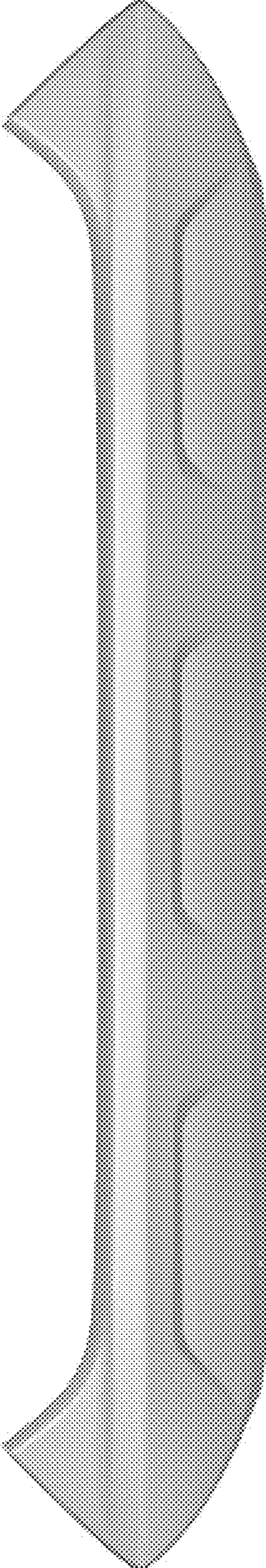

Figure 4

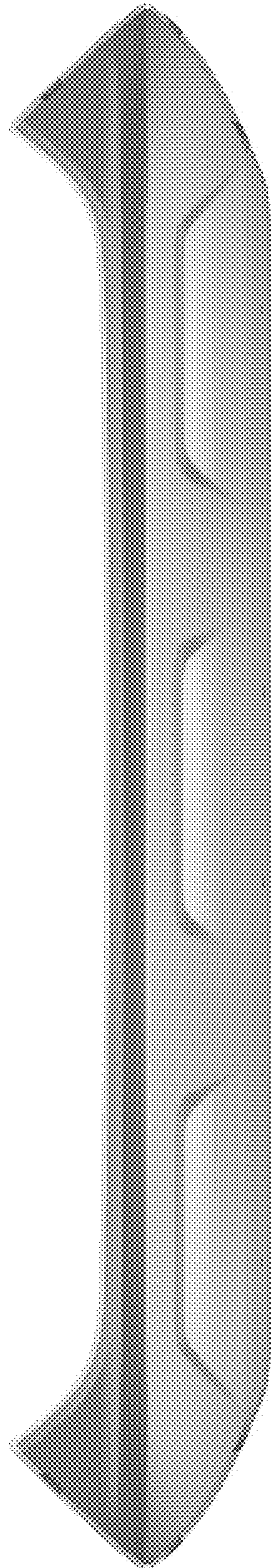

Figure 5

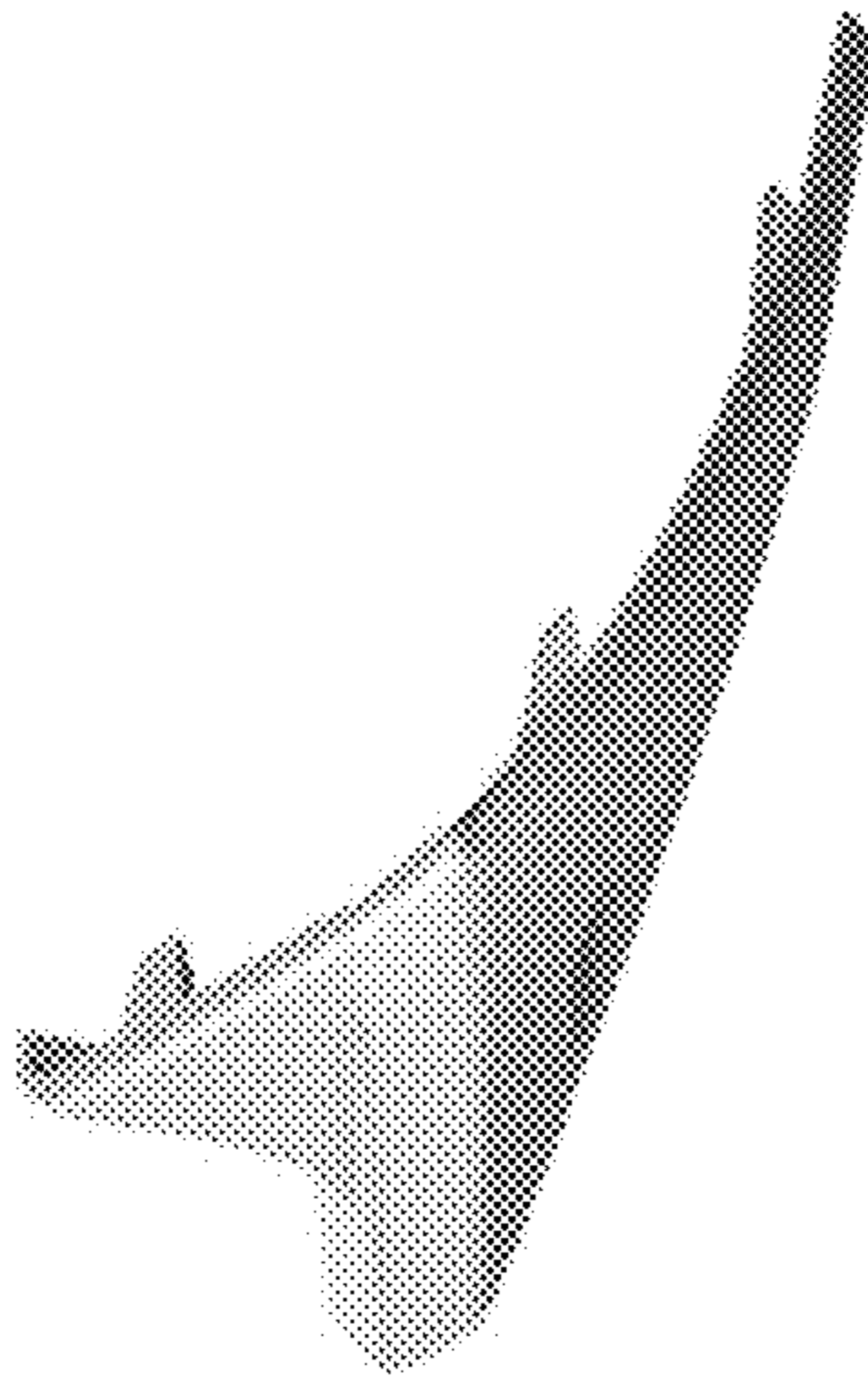

Figure 6



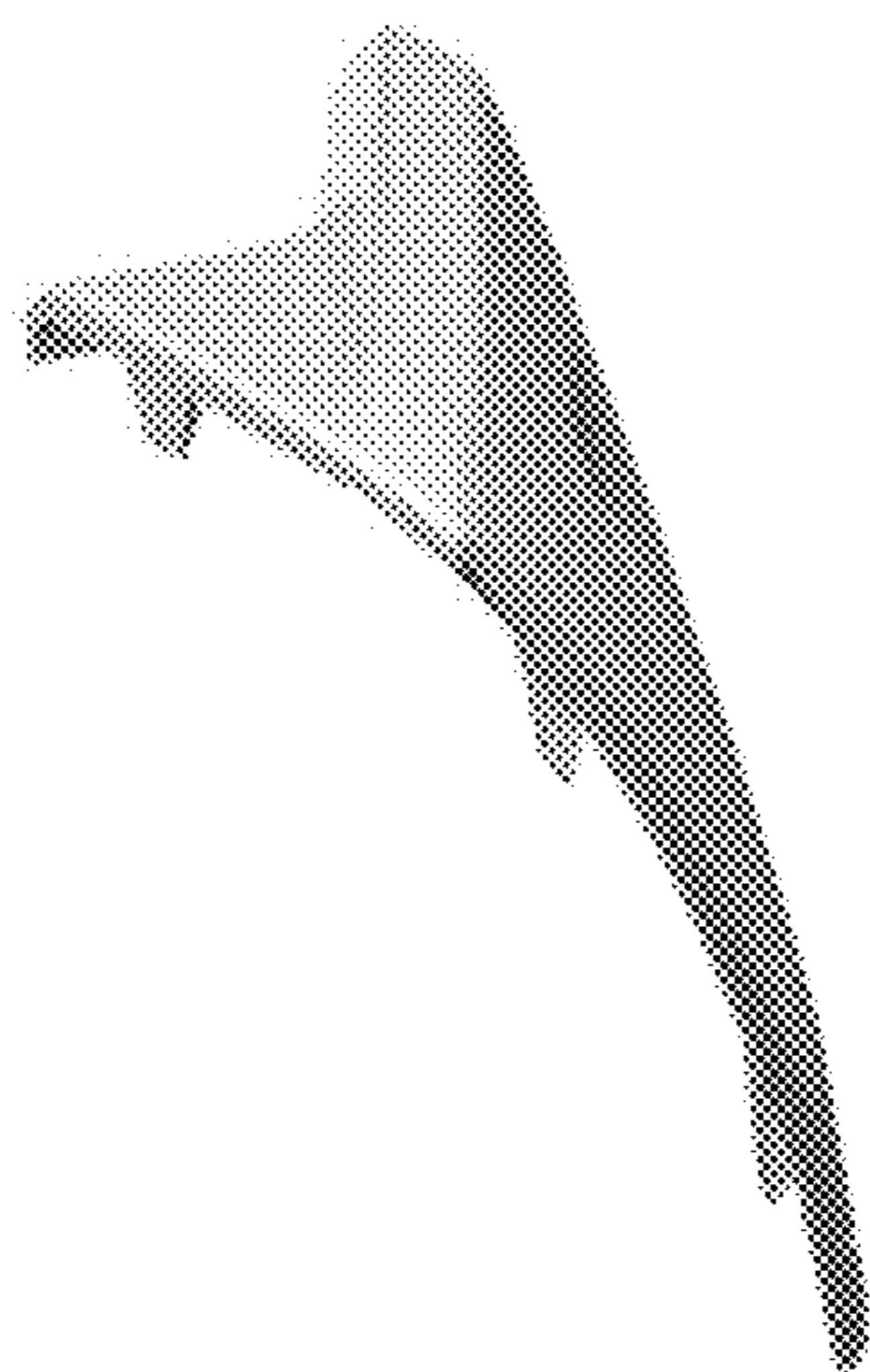

Figure 7

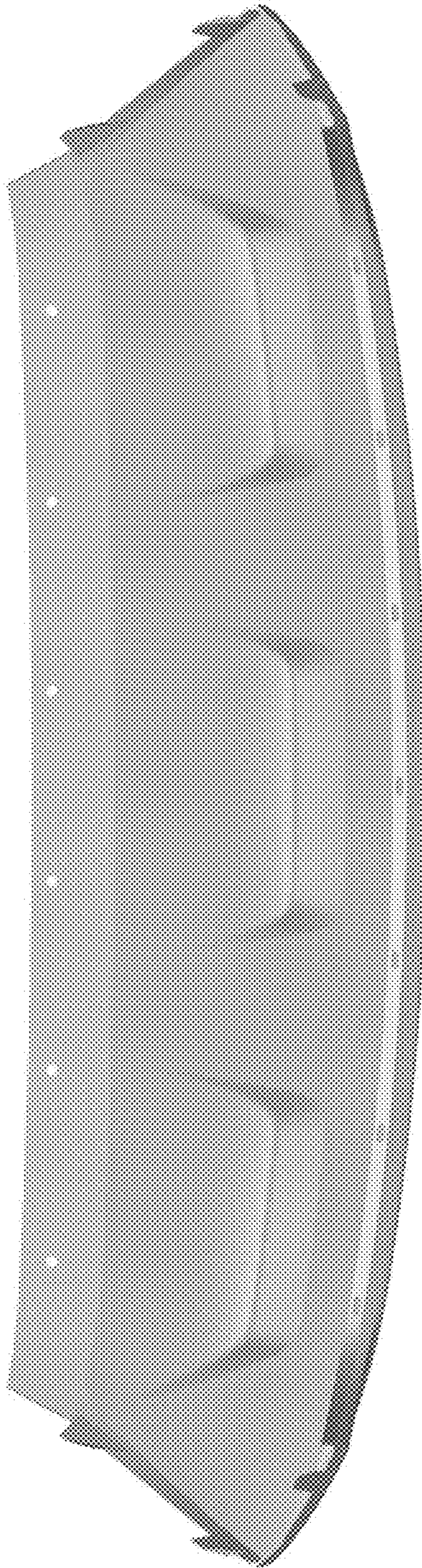

Figure 8

Figure 9

