



US00D800569S

(12) **United States Design Patent**
Eziquiel-Shriro

(10) **Patent No.:** **US D800,569 S**

(45) **Date of Patent:** **** Oct. 24, 2017**

(54) **BOTTLE**

(71) Applicant: **Berlin Packaging, LLC**, Chicago, IL
(US)

(72) Inventor: **Jonathan Eziquiel-Shriro**, Chicago, IL
(US)

(73) Assignee: **Berlin Packaging, LLC**, Chicago, IL
(US)

(**) Term: **15 Years**

(21) Appl. No.: **29/570,441**

(22) Filed: **Jul. 8, 2016**

(51) **LOC (10) Cl.** **09-01**

(52) **U.S. Cl.**
USPC **D9/543**; D9/563; D9/565; D9/571;
D9/575

(58) **Field of Classification Search**

USPC D9/651, 658, 523-524, 528, 530-535,
D9/548, 549-550, 574, 575, 520, 522,
D9/526, 527, 553, 555, 556, 557,
D9/563-570, 742, 516, 719, 536, 543,
D9/552, 542, 558, 571; 215/381-385, 10;
220/660, 669, 679, 752; D23/211.1, 225;
206/510; D7/612

CPC B65D 23/00; B65D 23/10; B65D 1/00;
B65D 1/02; B65D 21/00; B65D 21/02;
B65D 21/0201; B65D 21/0209; B65D
21/0233; B65D 21/0234; B65D 21/0237;
B65D 1/10; B65D 1/40; B65D 1/42;
B65D 11/04; B65D 2501/0081; B65D
2101/0053; B65D 1/0223; B65D 25/282;
B65D 25/2811; B65D 25/2808; B65D
25/2805; B65D 1/20; B65D 21/0231

See application file for complete search history.

(56) **References Cited**

U.S. PATENT DOCUMENTS

D303,628 S * 9/1989 Beaver D9/523
D415,689 S * 10/1999 Voight D9/523

D479,803 S * 9/2003 Alguire D9/523
D618,551 S * 6/2010 Salotti D9/523
D630,516 S * 1/2011 Kissinger D9/523
D651,093 S * 12/2011 Van Rens D9/541
D659,544 S * 5/2012 Labadie D9/542
D666,105 S * 8/2012 Cummings D9/543
D683,628 S * 6/2013 Claassen D9/453
D761,116 S * 7/2016 Berger D9/563
D770,903 S * 11/2016 Berger D9/563
D778,163 S * 2/2017 Dilley D9/523
D784,818 S * 4/2017 Ozamiz D23/211.1

* cited by examiner

Primary Examiner — Anhdao Doan

Assistant Examiner — Mary Malley

(74) *Attorney, Agent, or Firm* — Adam K. Sacharoff;
Much Shelist, P.C.

(57) **CLAIM**

The ornamental design for a bottle, as shown and described.

DESCRIPTION

FIG. 1 is a rear right side perspective view showing the new design for a bottle;
FIG. 2 is a rear left side perspective view thereof;
FIG. 3 is a front right side perspective view, taken from beneath the bottle;
FIG. 4 is a front left side perspective view, taken from beneath the bottle;
FIG. 5 is a right side view thereof;
FIG. 6 is a left side view thereof;
FIG. 7 is a rear view thereof;
FIG. 8 is a front view thereof;
FIG. 9 is a bottom plan view thereof; and,
FIG. 10 is a top plan view thereof.
The broken lines show portions of the bottle that form no part of the claimed design.

1 Claim, 10 Drawing Sheets

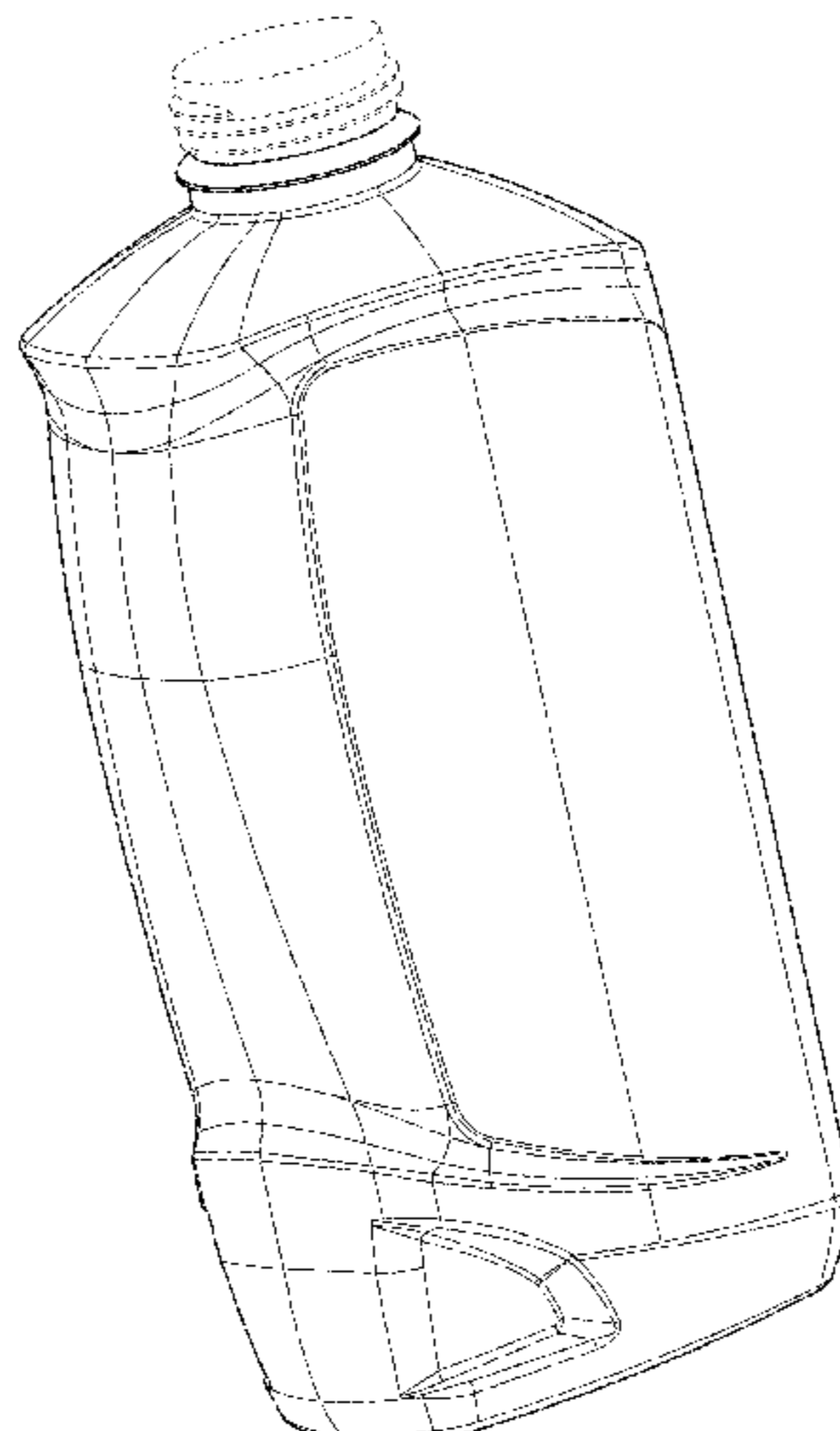

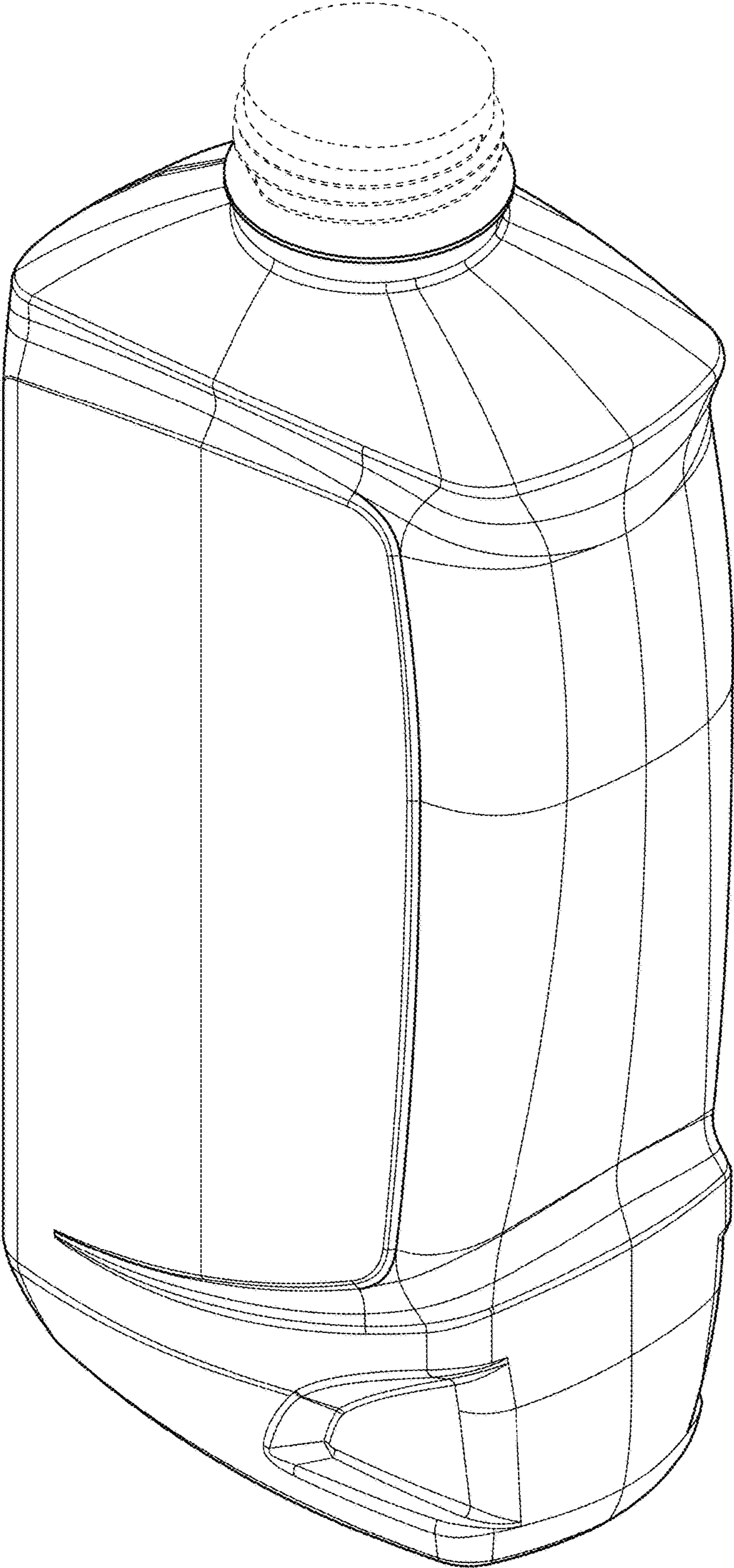

FIG. 1

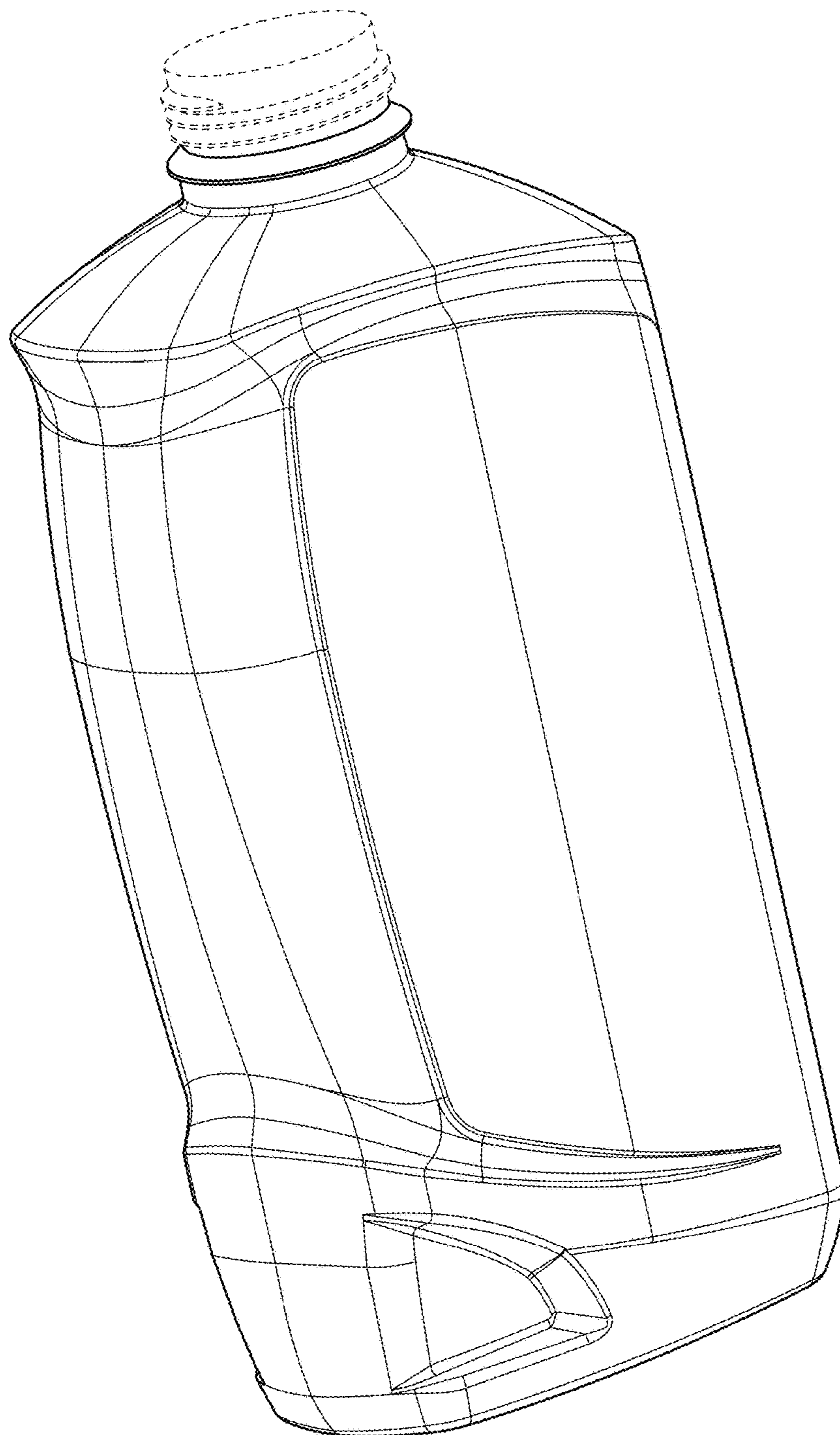

FIG. 2

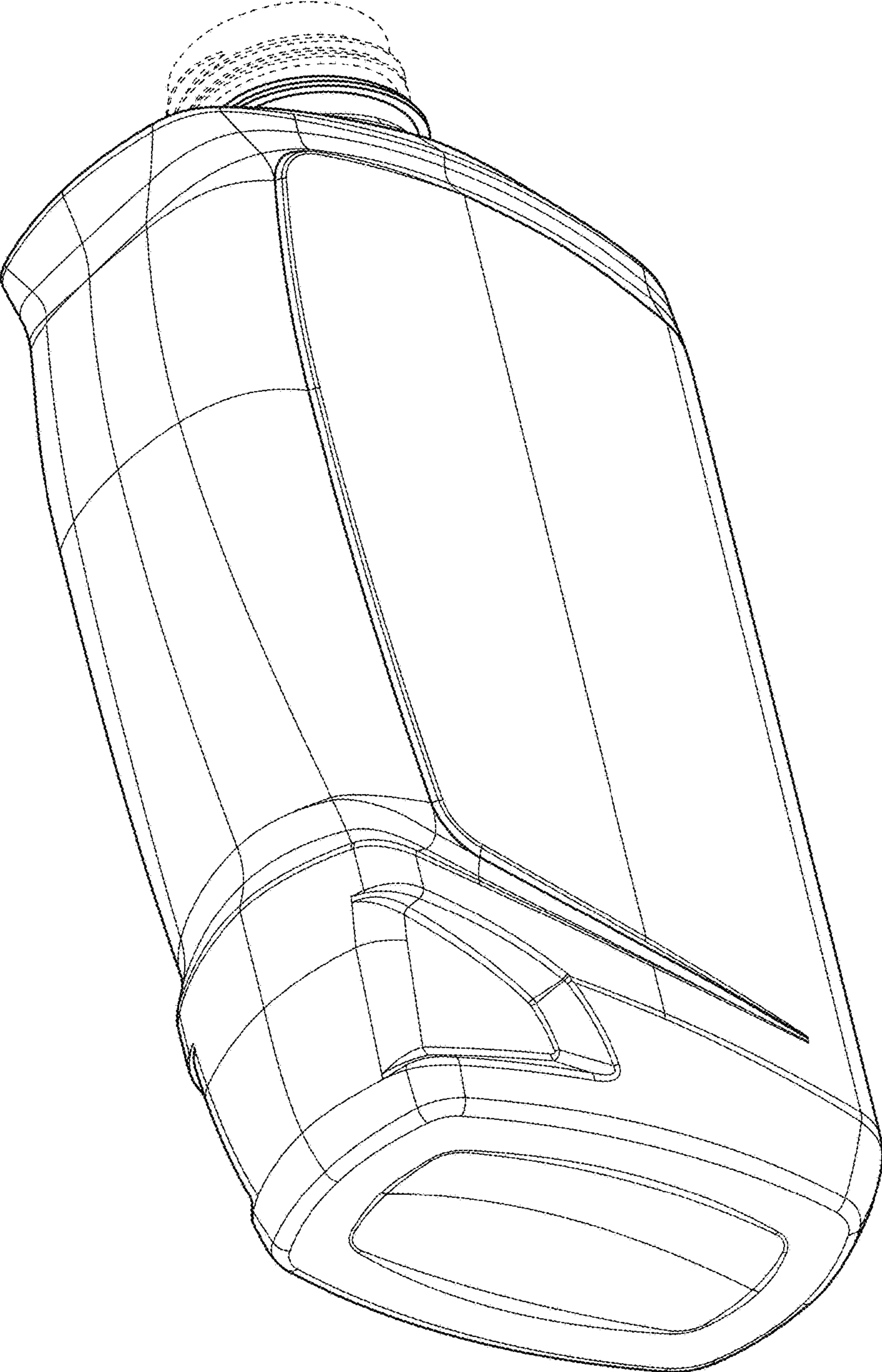

FIG. 3

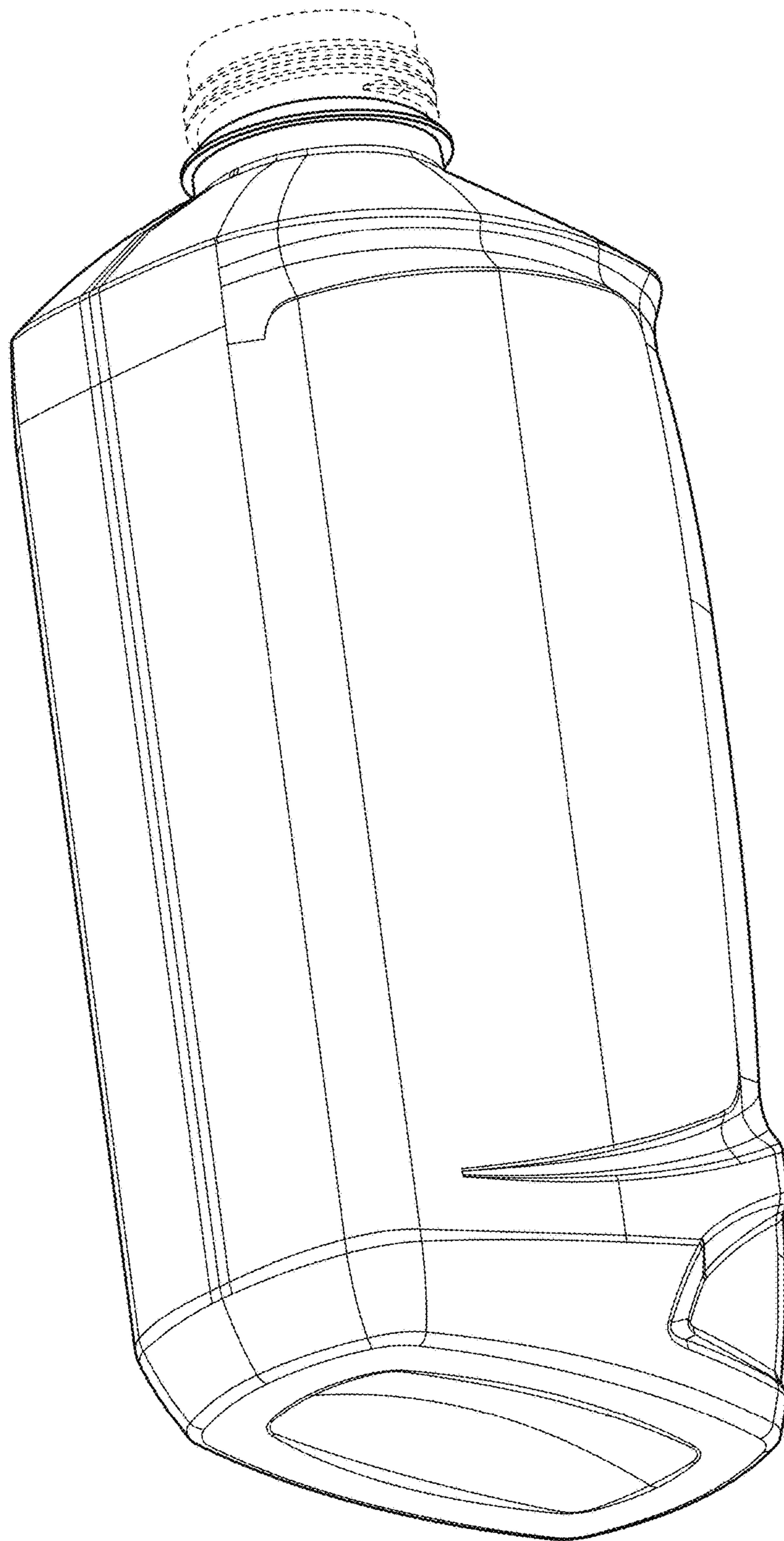

FIG. 4

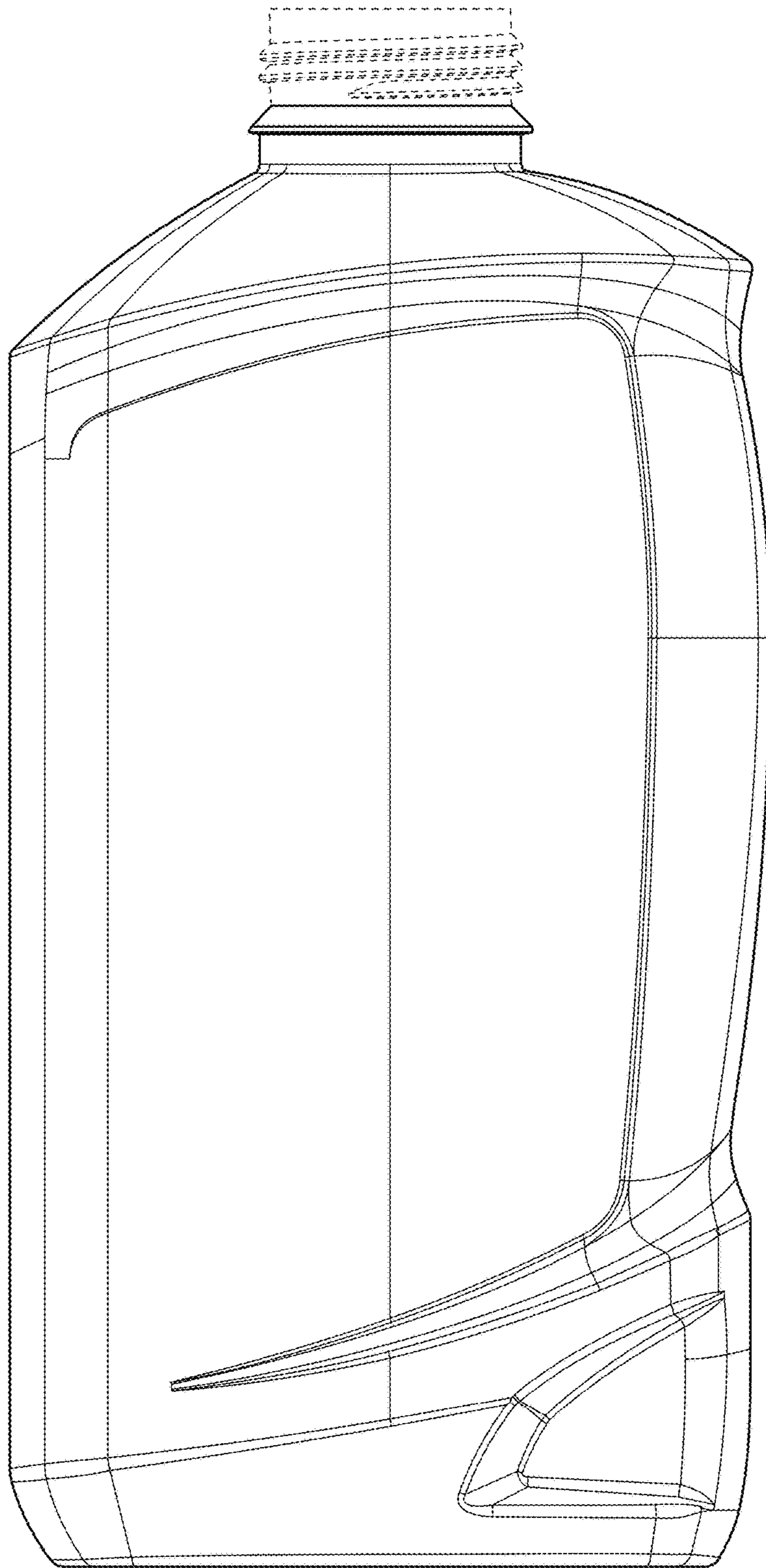

FIG. 5

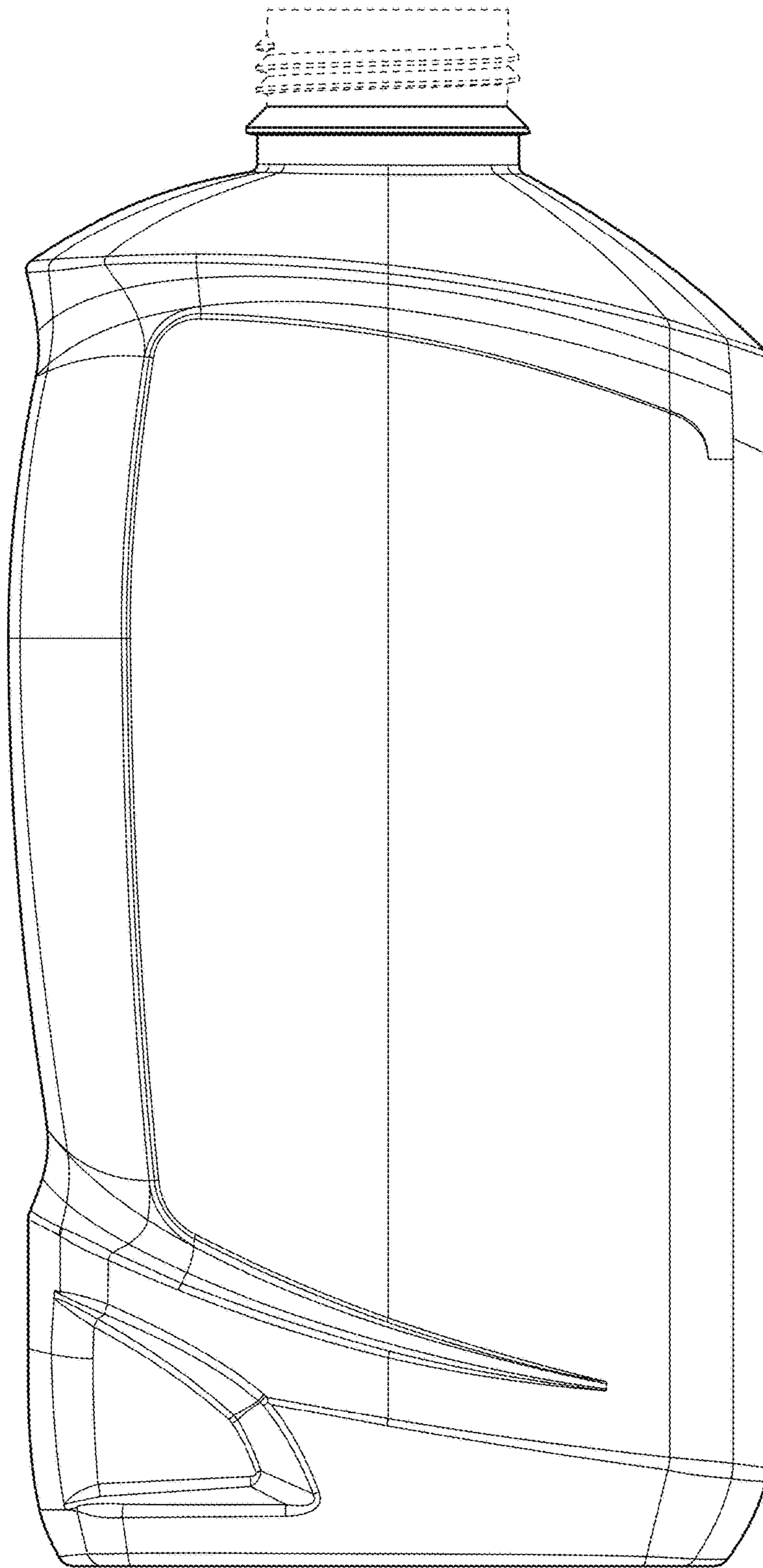

FIG. 6

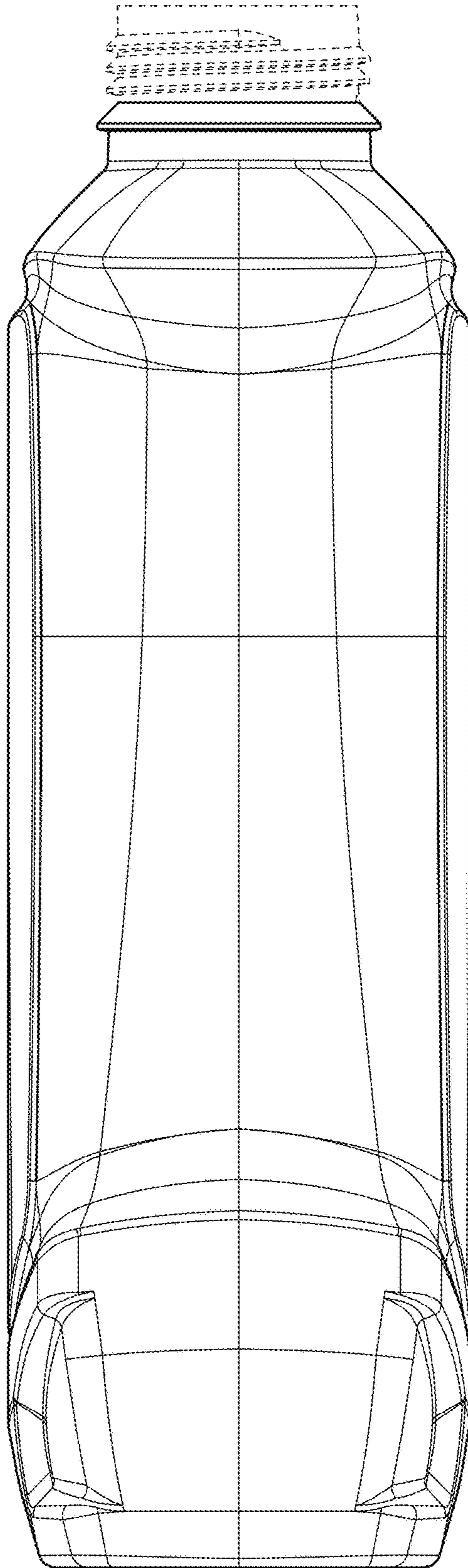

FIG. 7

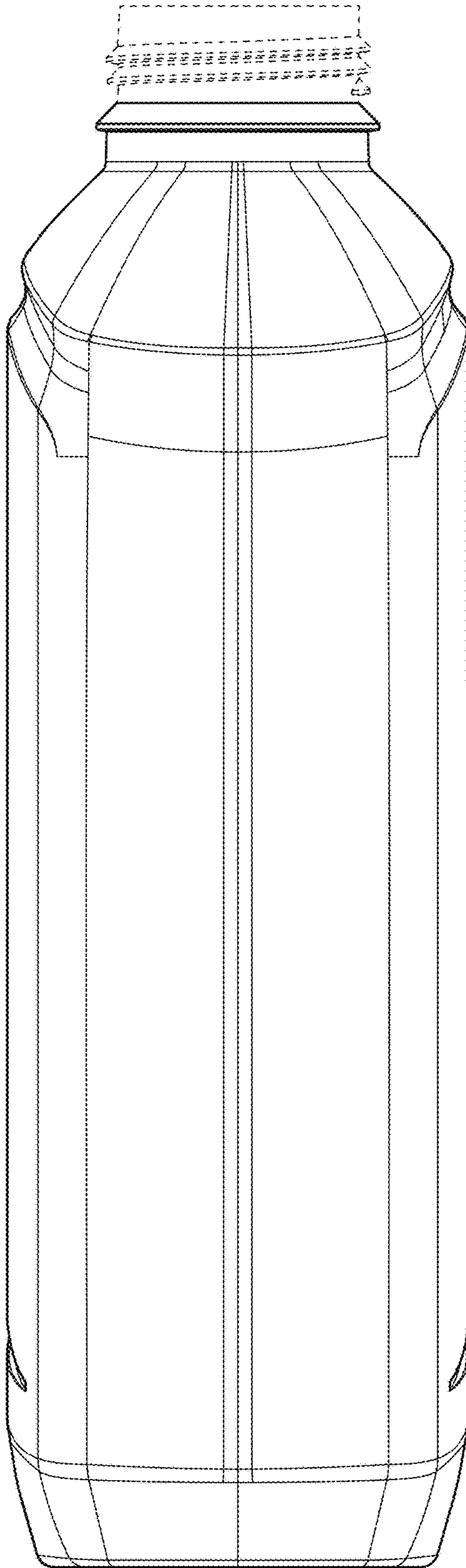

FIG. 8

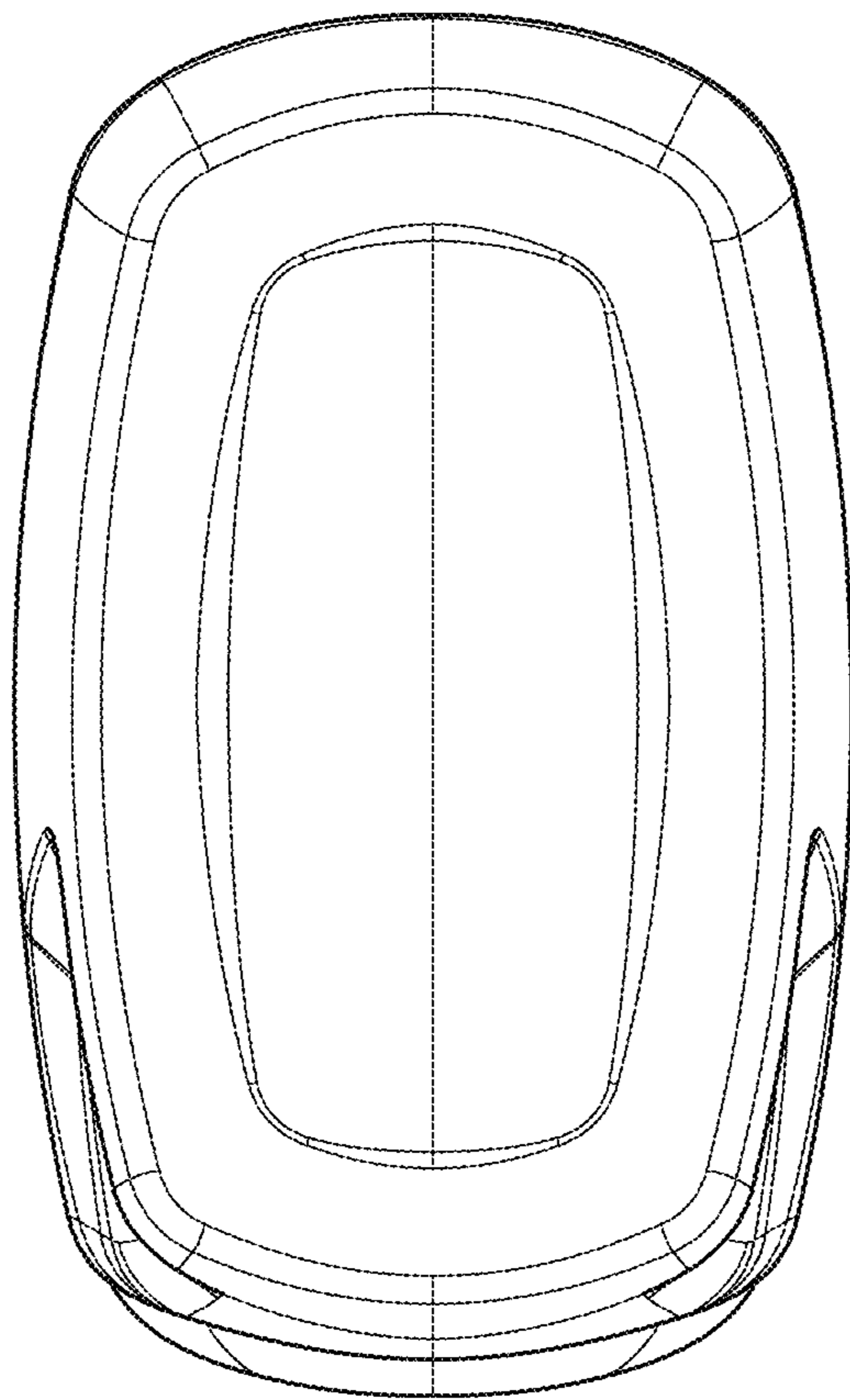

FIG. 9

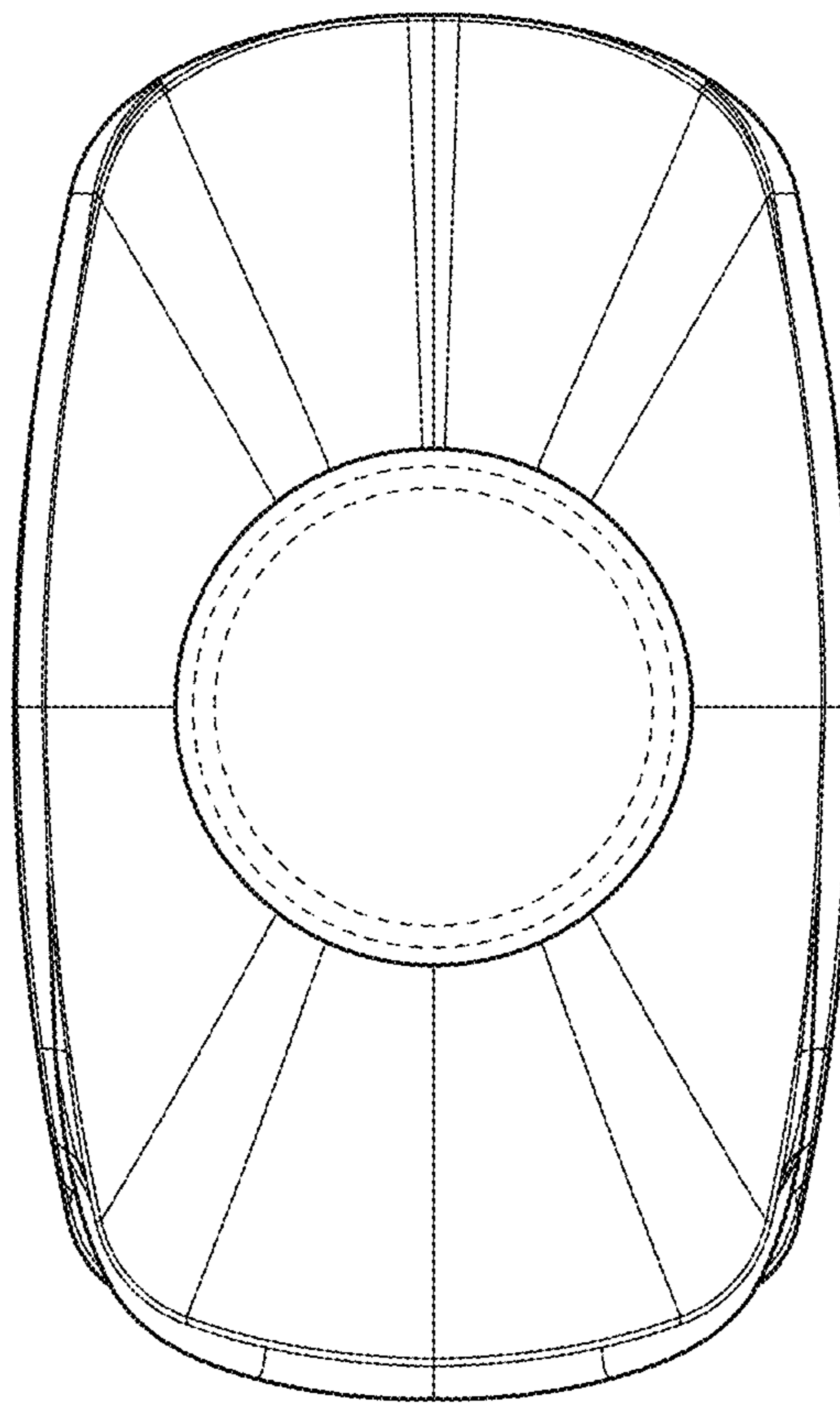

FIG. 10