

US00D800563S

(12) **United States Design Patent** (10) **Patent No.:** **US D800,563 S**
Nguyen et al. (45) **Date of Patent:** **** Oct. 24, 2017**

(54) **BOTTLE WITH A CUP**
(71) Applicant: **Dr. Fresh, LLC**, Buena Park, CA (US)
(72) Inventors: **Huy Kha Nguyen**, Anaheim, CA (US);
Doug Corbett, New Canaan, CT (US)
(73) Assignee: **DR. FRESH, LLC**, Buena Park, CA
(US)

D594,340 S 6/2009 Eilken et al.
D599,206 S * 9/2009 Eilken D9/516
D608,648 S * 1/2010 Rhodes D9/529
D619,462 S 7/2010 Cummings et al.
D643,732 S 8/2011 Cummings et al.
D643,738 S 8/2011 Cummings et al.
D650,284 S 12/2011 Schriener et al.
D650,680 S * 12/2011 Hodges D9/521
D661,599 S * 6/2012 Floyd D9/729

(Continued)

(**) Term: **15 Years**

OTHER PUBLICATIONS

(21) Appl. No.: **29/549,943**

“Reach Complete Care for Clean Teeth.” mypinterventures.com.
Last commented on Aug. 9, 2015. Accessed Apr. 27, 2017. Available
online at URL: <http://mypinterventures.com/reach-complete-care-
for-clean-teeth/>.*

(22) Filed: **Dec. 29, 2015**

(51) **LOC (10) Cl.** **09-01**

(52) **U.S. Cl.**

USPC **D9/523**

(58) **Field of Classification Search**

USPC D7/300–322, 396.2, 509–511, 523, 589,
D7/598, 612, 615, 619.1; D9/500–575;
215/40–55, 316–354, 370–385;
220/574–575

CPC . B05B 11/0089; B29D 23/20; B29L 2023/20;
B65D 1/00; B65D 1/02; B65D 1/0223;
B65D 1/023; B65D 1/0276; B65D
47/0857; B65D 81/3288; F04B 9/14

See application file for complete search history.

(Continued)

Primary Examiner — Cathron C Brooks

Assistant Examiner — Christian P. McLean

(74) *Attorney, Agent, or Firm* — Snell & Wilmer L.L.P.

(57) **CLAIM**

We claim the ornamental design for a bottle with a cup, as
shown and described.

DESCRIPTION

(56) **References Cited**

U.S. PATENT DOCUMENTS

D198,817 S * 8/1964 Stahl D9/693
D219,333 S * 12/1970 Doblin D9/688
D400,784 S * 11/1998 Cummings D9/686
D452,142 S * 12/2001 Wilson D9/522
D499,012 S 11/2004 Illenberger et al.
D502,404 S * 3/2005 Hunt D9/530
D512,634 S * 12/2005 Illenberger D9/447
D525,872 S * 8/2006 Haubert D9/529
D529,814 S 10/2006 Winkler et al.
D539,665 S 4/2007 Haubert et al.
D586,654 S 2/2009 Illenberger et al.

FIG. 1 is a perspective front view of the bottle with a cup
showing our new design;

FIG. 2 is a right side view of the bottle with a cup;

FIG. 3 is a left side view of the bottle with a cup;

FIG. 4 is a front view of the bottle with a cup;

FIG. 5 is a rear view of the bottle with a cup;

FIG. 6 is a top view of the bottle with a cup; and,

FIG. 7 is a perspective view of the cup that is placed within
the bottle.

The broken lines illustrate portions of the bottle and portions
of the cup that form no part of the claimed design.

1 Claim, 7 Drawing Sheets

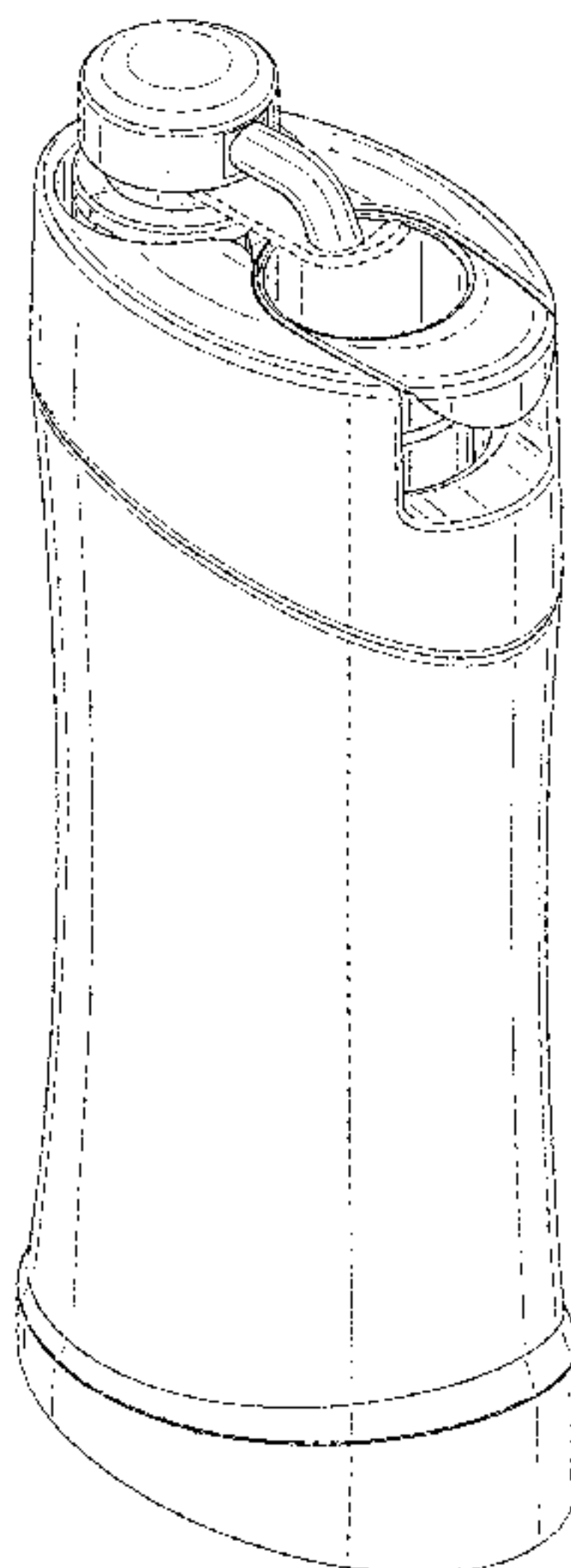

(56)

References Cited

U.S. PATENT DOCUMENTS

D666,104 S	8/2012	Cummings et al.	
D666,107 S *	8/2012	Blachford	D9/682
D683,226 S	5/2013	Baldrige et al.	
D686,922 S *	7/2013	Davis	D9/732
D688,131 S *	8/2013	Crawford	D9/449
D719,450 S	12/2014	Jordan et al.	
D739,751 S *	9/2015	Kahler	D9/529
D740,668 S *	10/2015	de Vries	D9/526
D740,669 S *	10/2015	de Vries	D9/526
D743,261 S *	11/2015	Jordan	D9/529
D744,839 S *	12/2015	Nguyen	D9/523
D770,900 S *	11/2016	Hendricks	D9/516
D773,305 S *	12/2016	Toh	D9/449
D781,153 S *	3/2017	Blake	D9/529
D784,145 S *	4/2017	Robinson, II	D9/543

OTHER PUBLICATIONS

“Declutter your countertop with REACH Complete Care.”
YouTube.com. 0:49. Published Sep. 30, 2015. Accessed Apr. 27,
2017. Available online at URL: <[https://www.youtube.com/
watch?v=DcFmj4jcu5U](https://www.youtube.com/watch?v=DcFmj4jcu5U)>.*

* cited by examiner

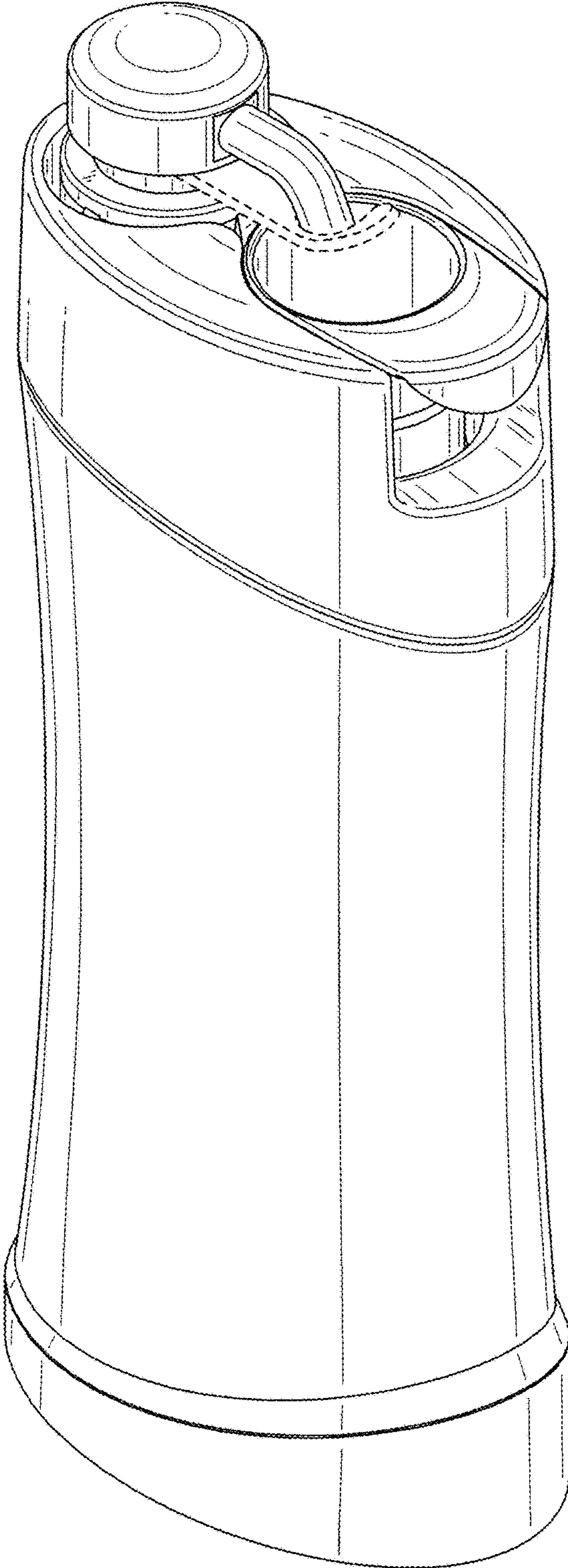

FIG. 1

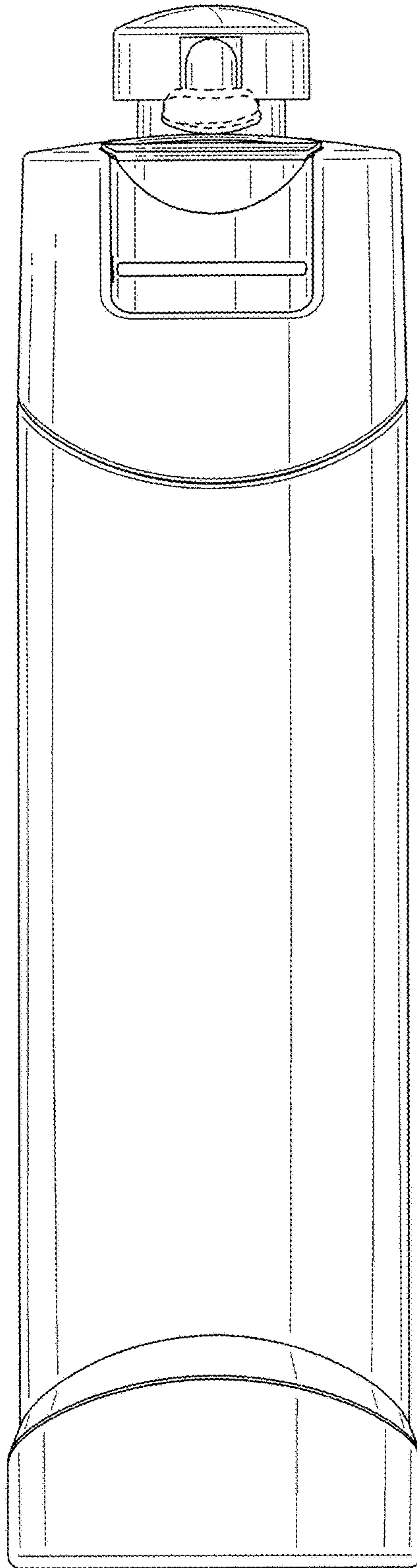

FIG. 2

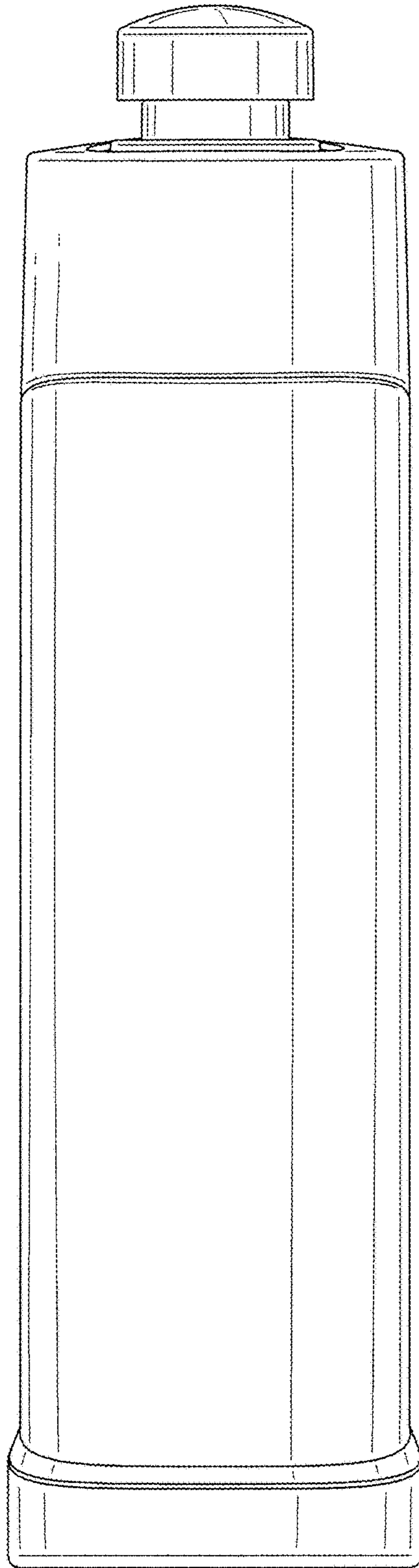

FIG. 3

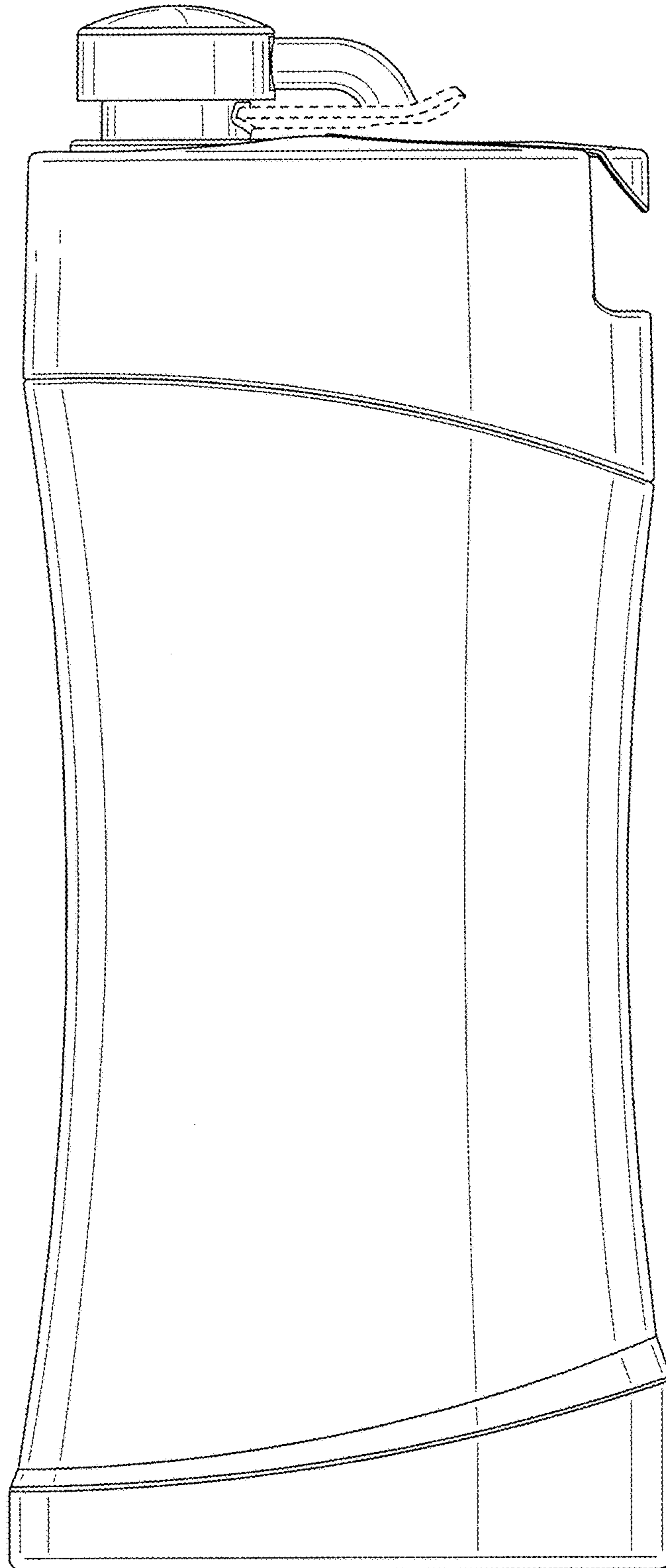

FIG. 4

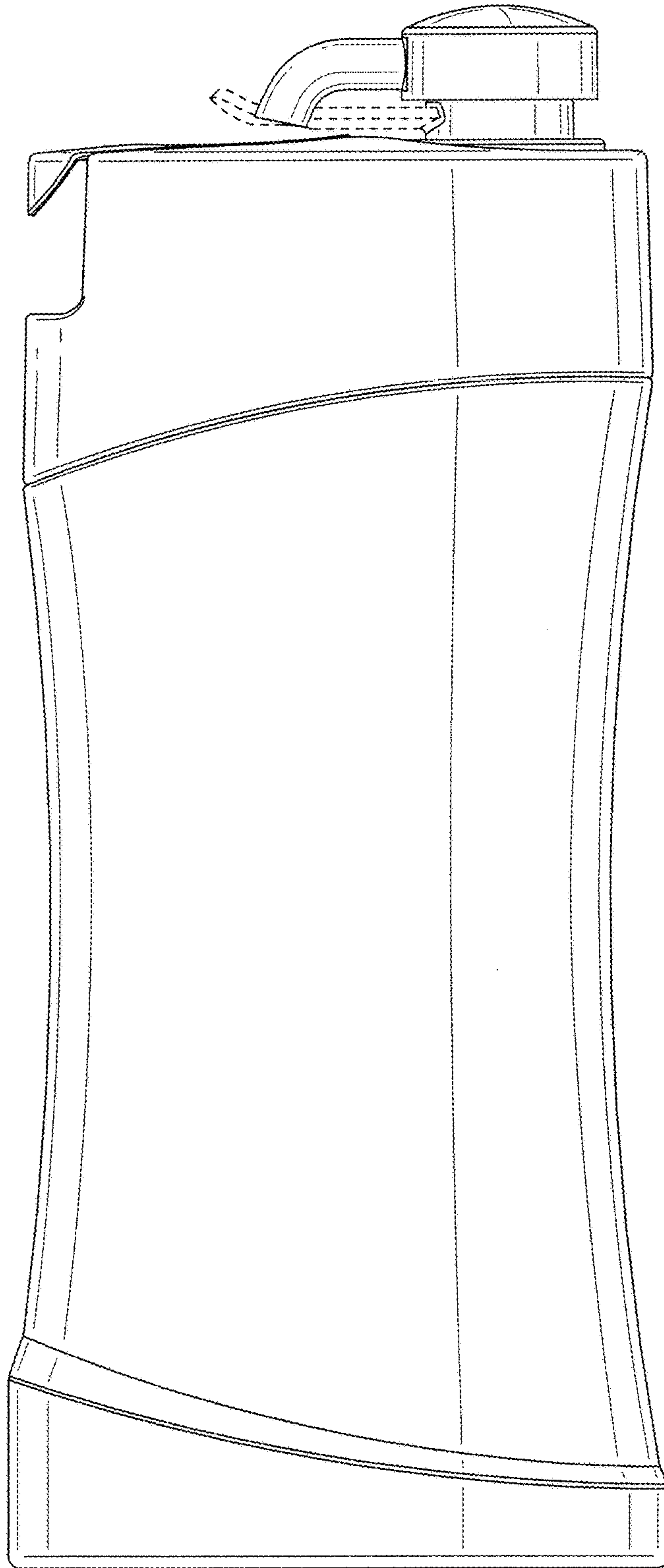

FIG. 5

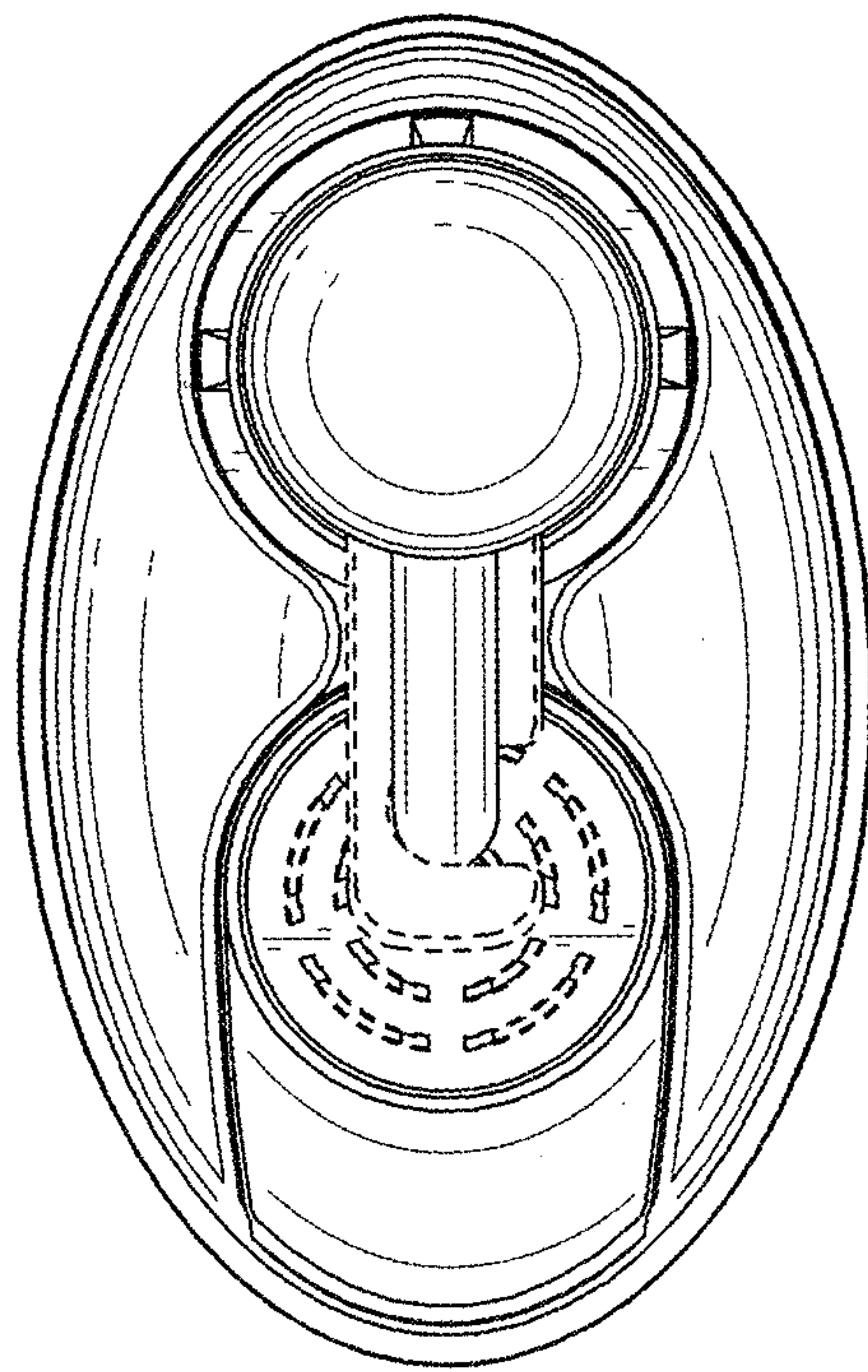

FIG. 6

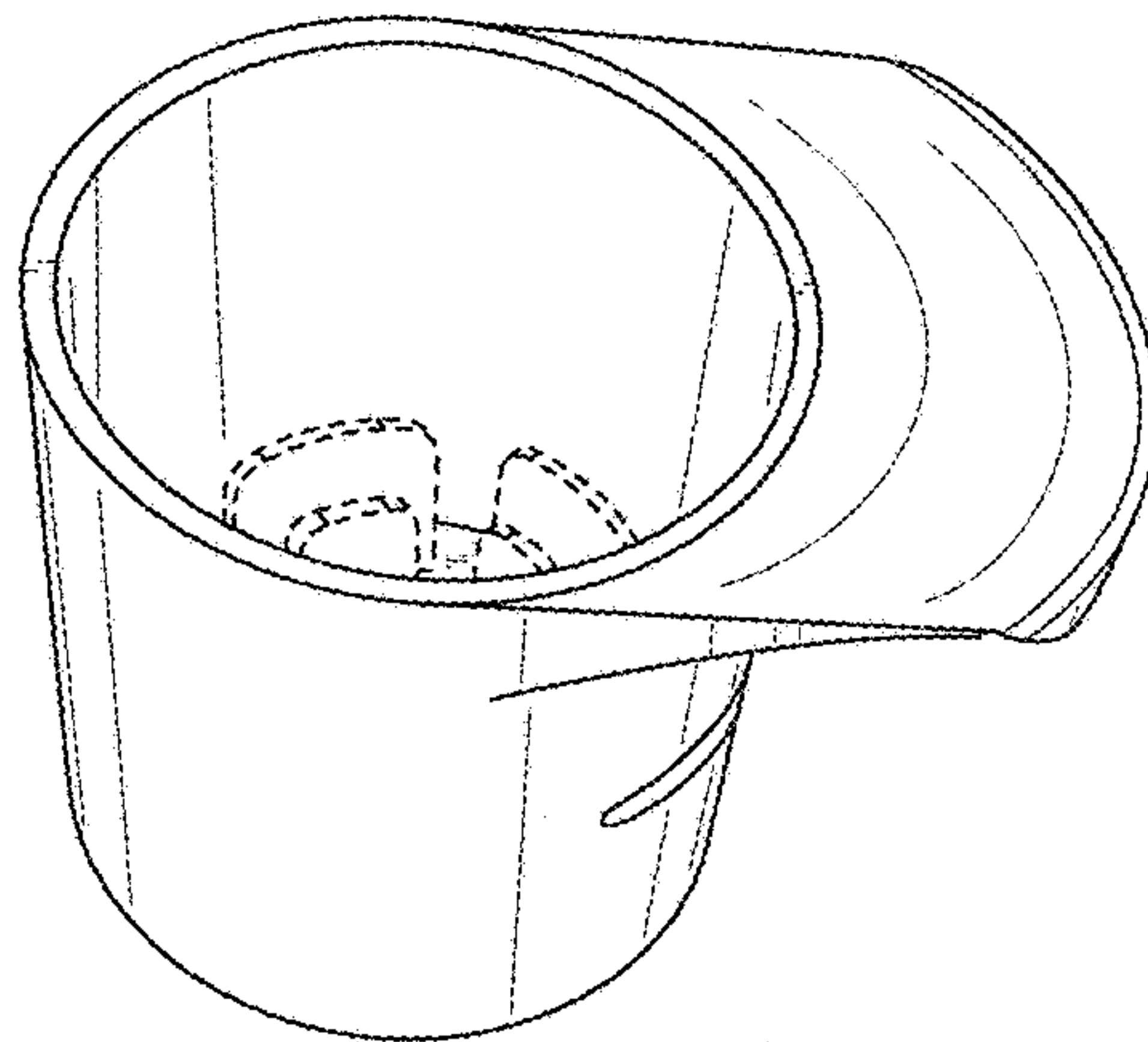

FIG. 7