



US00D800338S

(12) **United States Design Patent**
Black

(10) **Patent No.:** **US D800,338 S**

(45) **Date of Patent:** **** Oct. 17, 2017**

- (54) **BLOOD COOLING TRAY**
- (71) Applicant: **Jay Black**, Escondido, CA (US)
- (72) Inventor: **Jay Black**, Escondido, CA (US)
- (**) Term: **15 Years**
- (21) Appl. No.: **29/570,193**
- (22) Filed: **Jul. 6, 2016**
- (51) **LOC (10) Cl.** **24-02**
- (52) **U.S. Cl.**
USPC **D24/229**
- (58) **Field of Classification Search**
USPC D24/224, 229, 107, 216; 422/44, 46, 50,
422/500, 560-562, 430, 65; 211/71.01,
211/74, 13.1, 85.13
CPC ... A01N 1/0263; A61J 1/05; A61J 1/10; A61J
1/12; G01N 15/04; G01N 15/05
See application file for complete search history.

- 7,276,208 B2 * 10/2007 Sevigny B01L 9/06
211/74
- 7,910,067 B2 * 3/2011 Knight B01L 9/06
211/71.01
- 8,246,919 B2 * 8/2012 Herchenbach B01L 9/06
211/71.01
- 8,591,838 B2 * 11/2013 Bulow B01L 9/06
422/562
- 2003/0017084 A1 * 1/2003 Dale B01L 9/06
422/562
- 2003/0215365 A1 * 11/2003 Sevigny B01L 9/06
422/64

* cited by examiner

Primary Examiner — Susan Bennett Hattan
Assistant Examiner — Rebecca Tsehaye
 (74) *Attorney, Agent, or Firm* — Gary L. Eastman, Esq.;
 Eastman & McCartney LLP

(57) **CLAIM**

The ornamental design for a blood cooling tray, as shown and described.

DESCRIPTION

FIG. 1 is a top-left perspective view of a blood cooling tray; FIG. 2 is a back-right-top perspective view of the blood cooling tray; FIG. 3 is a front-left-bottom perspective view of the blood cooling tray; FIG. 4 is a front elevational view of the blood cooling tray; FIG. 5 is a back elevational view of the blood cooling tray; FIG. 6 is a left side elevational view of the blood cooling tray; FIG. 7 is a right side elevational view of the blood cooling tray; FIG. 8 is a top plan view of the blood cooling tray; and, FIG. 9 is a bottom plan view of the blood cooling tray.

1 Claim, 9 Drawing Sheets

(56) **References Cited**

U.S. PATENT DOCUMENTS

- D136,305 S 9/1943 Teeter
- 2,522,623 A 9/1950 Likes et al.
- 3,186,556 A * 6/1965 Forsstrom B01L 9/06
211/74
- D256,587 S 8/1980 Tatsumi
- 4,278,176 A * 7/1981 Adams B01L 9/06
206/443
- 4,281,768 A * 8/1981 Sommers B01L 9/06
211/74
- D285,692 S 9/1986 Albiez
- 4,801,428 A * 1/1989 Homolko G01N 15/05
33/783
- D325,975 S * 5/1992 Grade D19/83
- 5,671,991 A 9/1997 Grant
- D454,892 S 3/2002 Black et al.

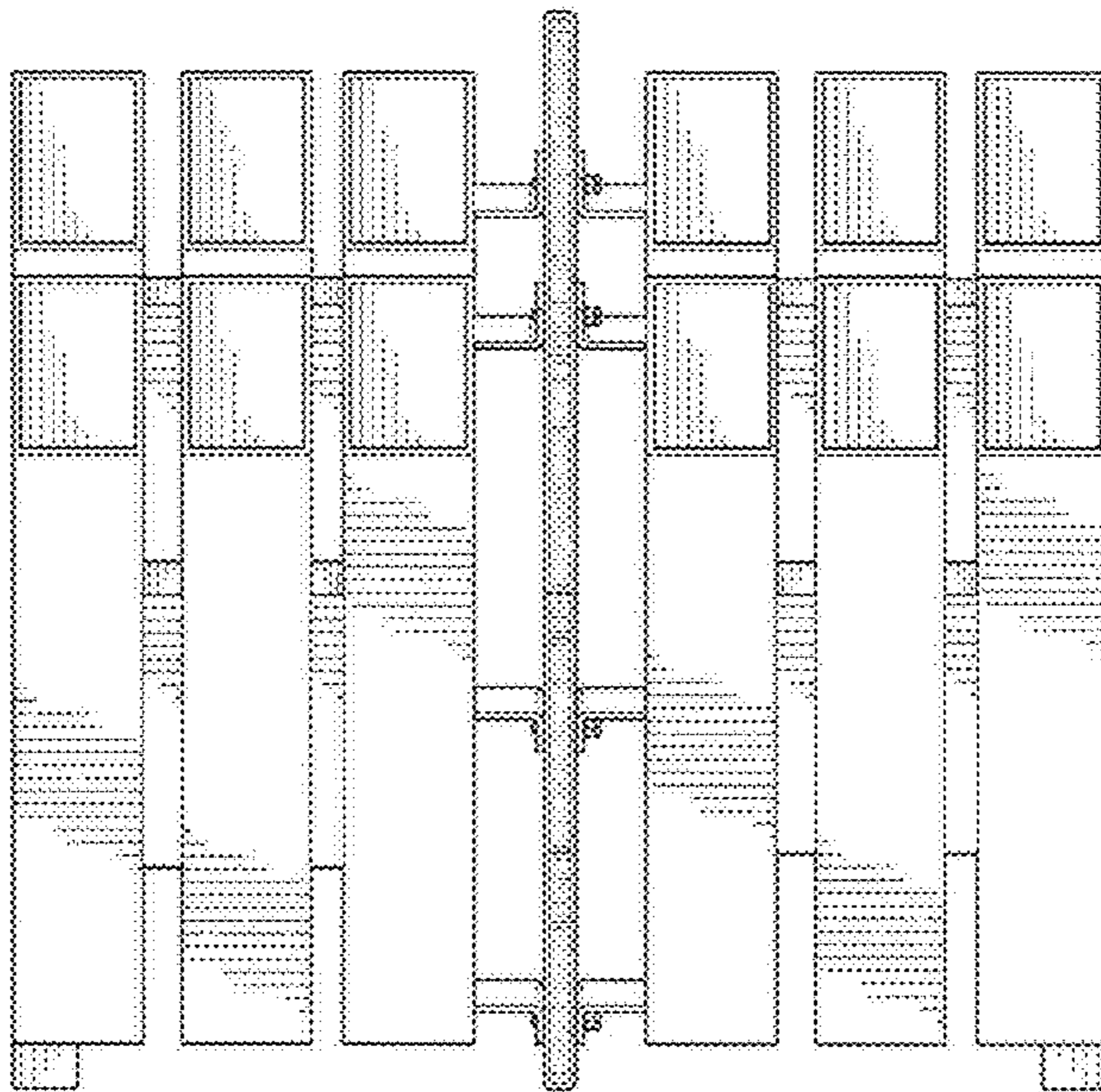

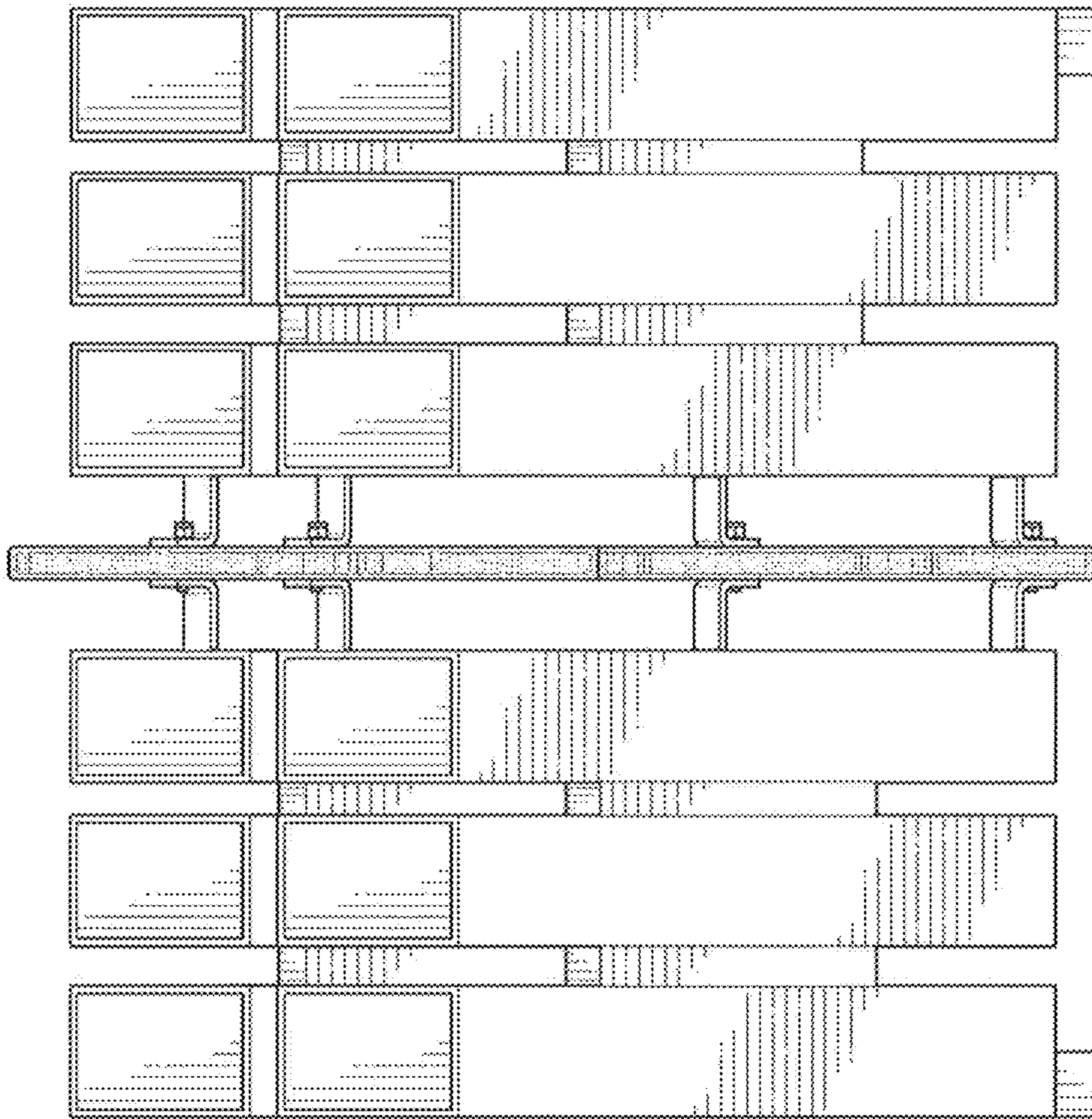

FIG. 1

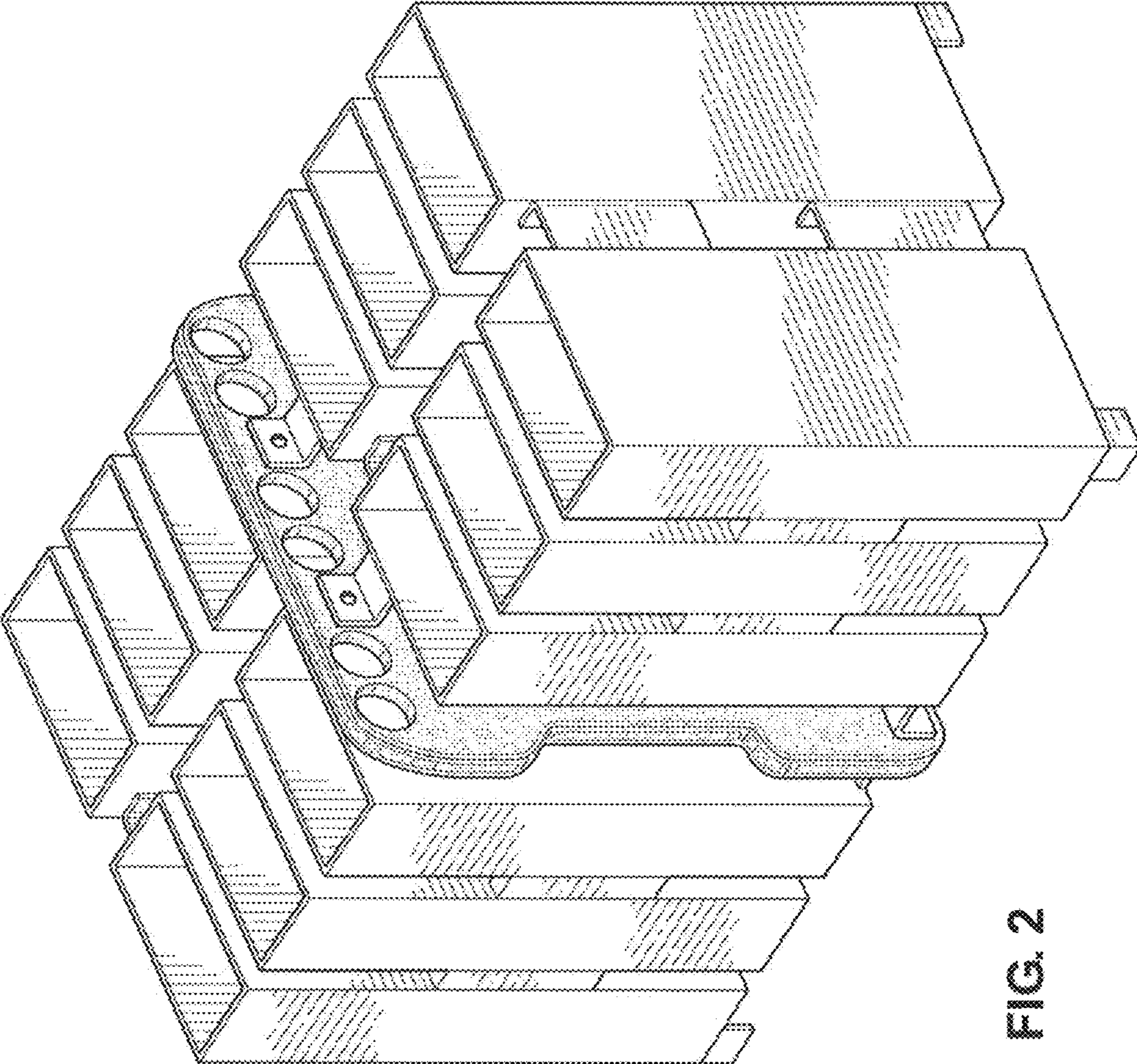

FIG. 2

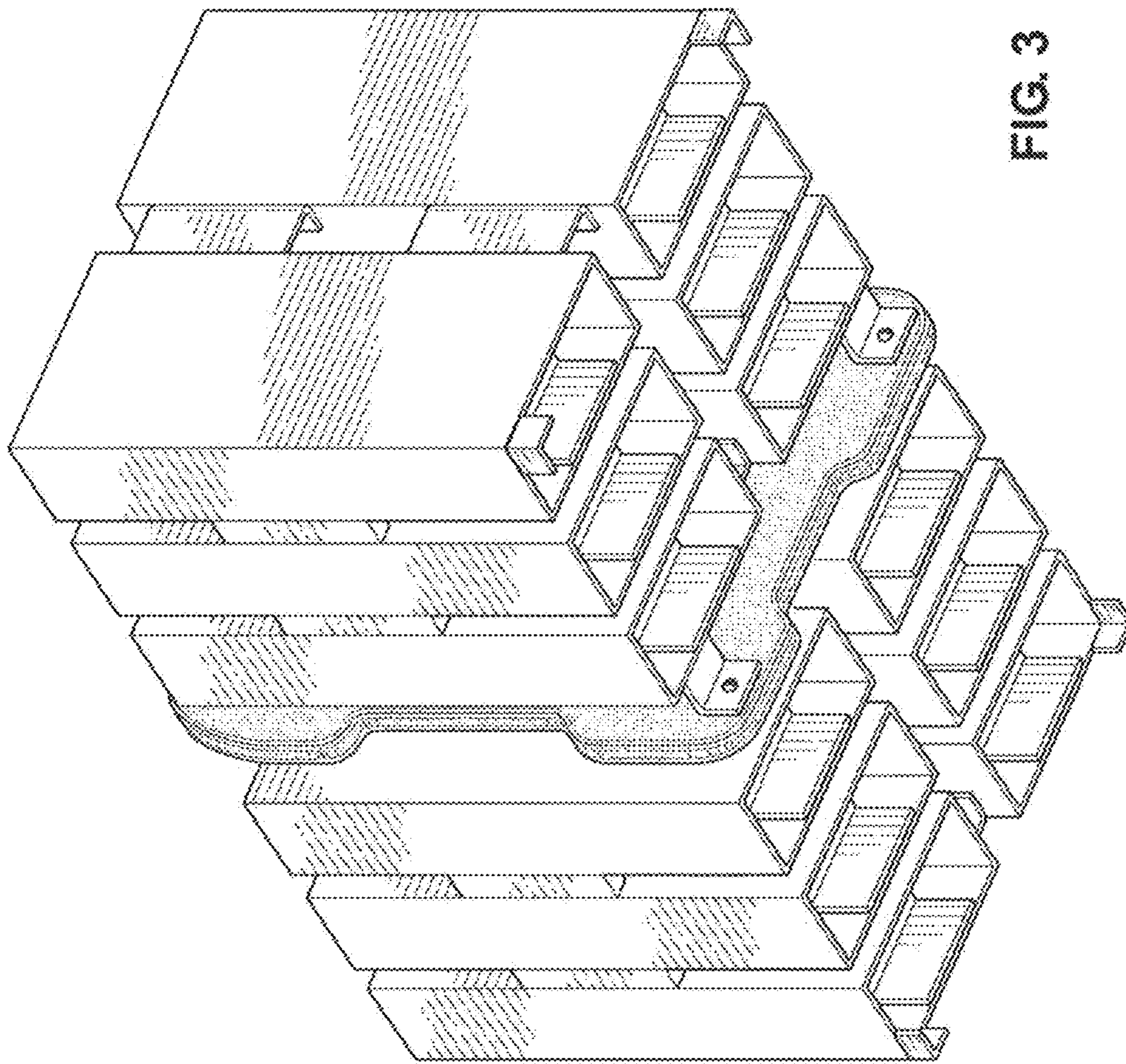

FIG. 3

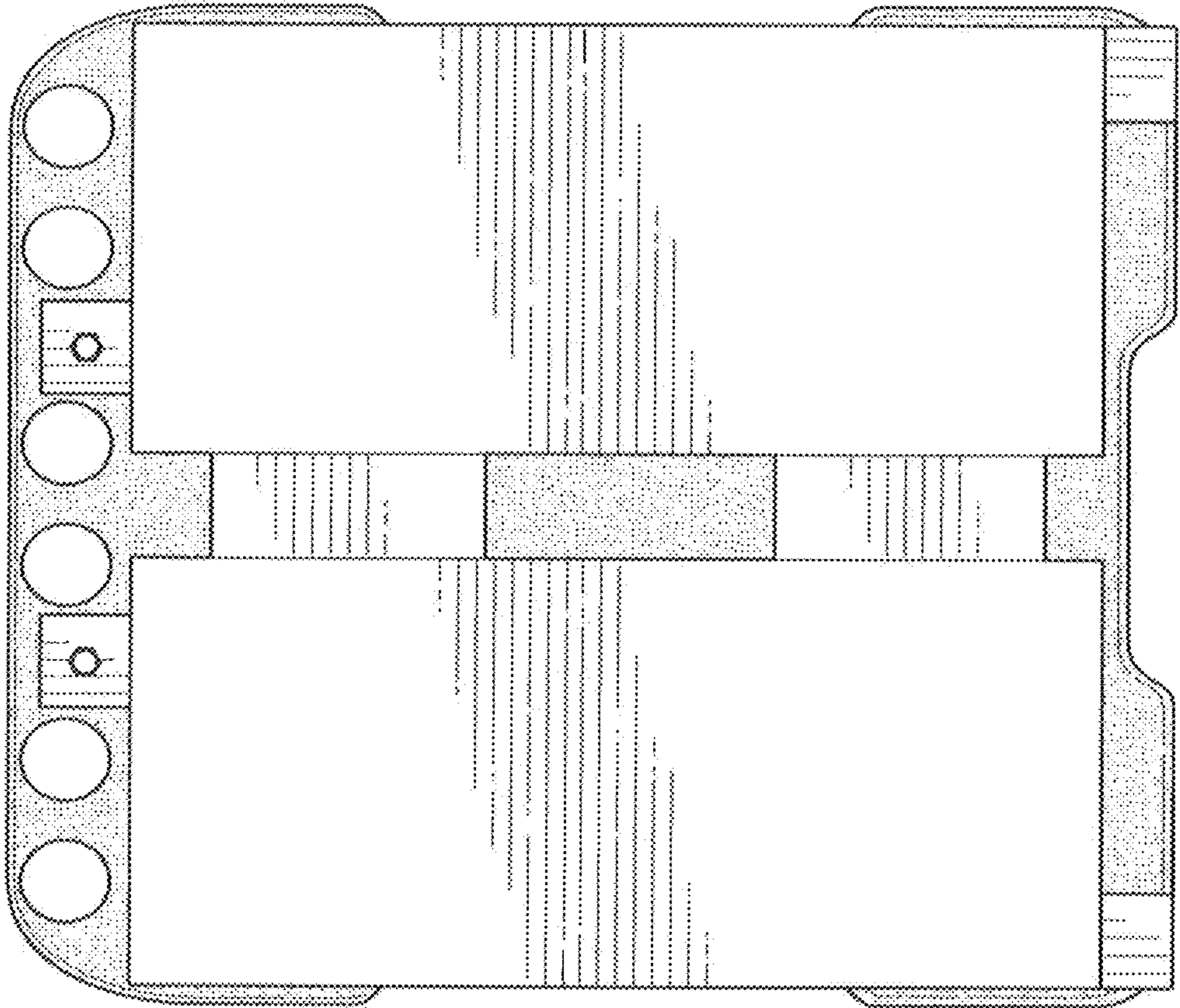

FIG. 4

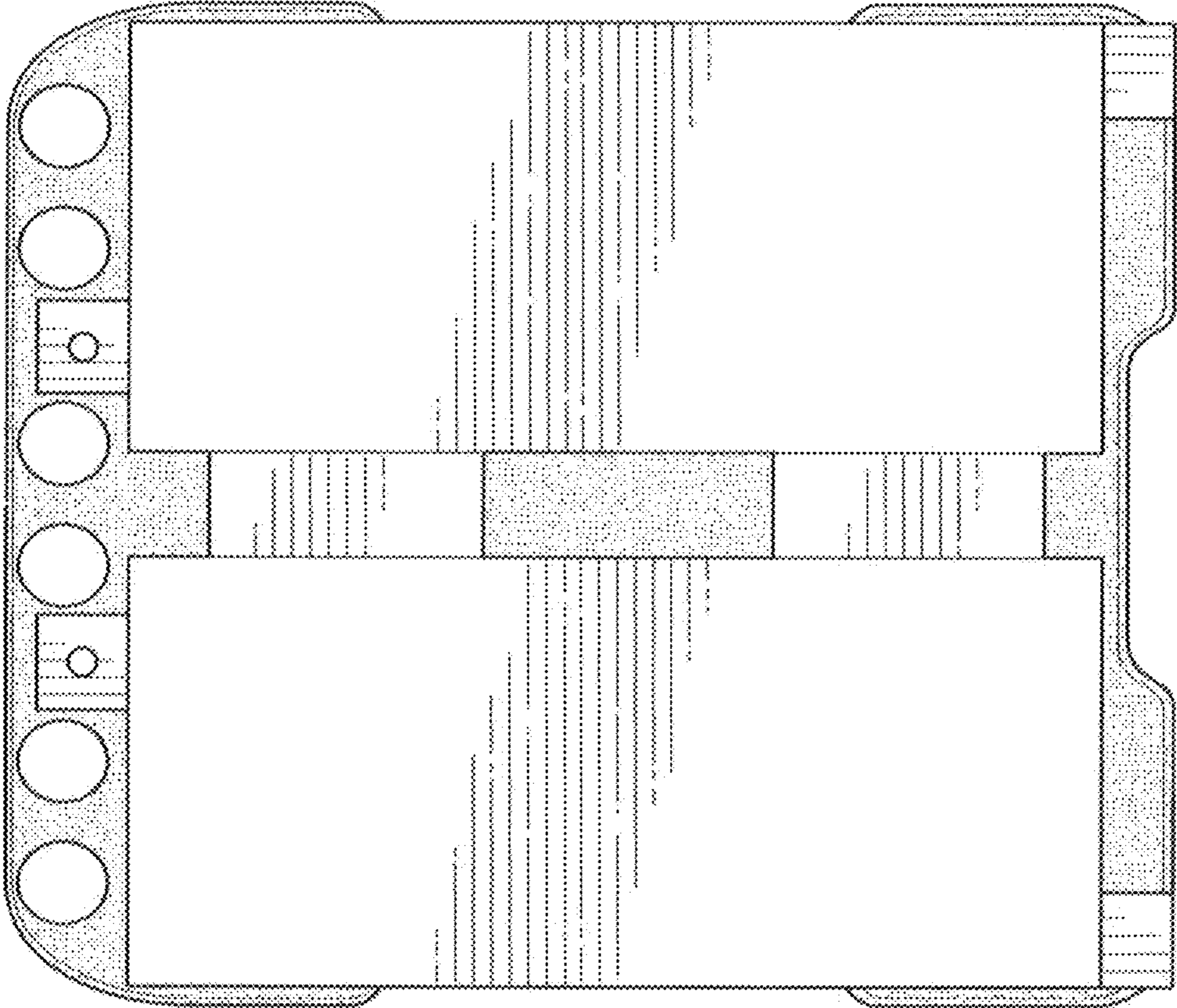

FIG. 5

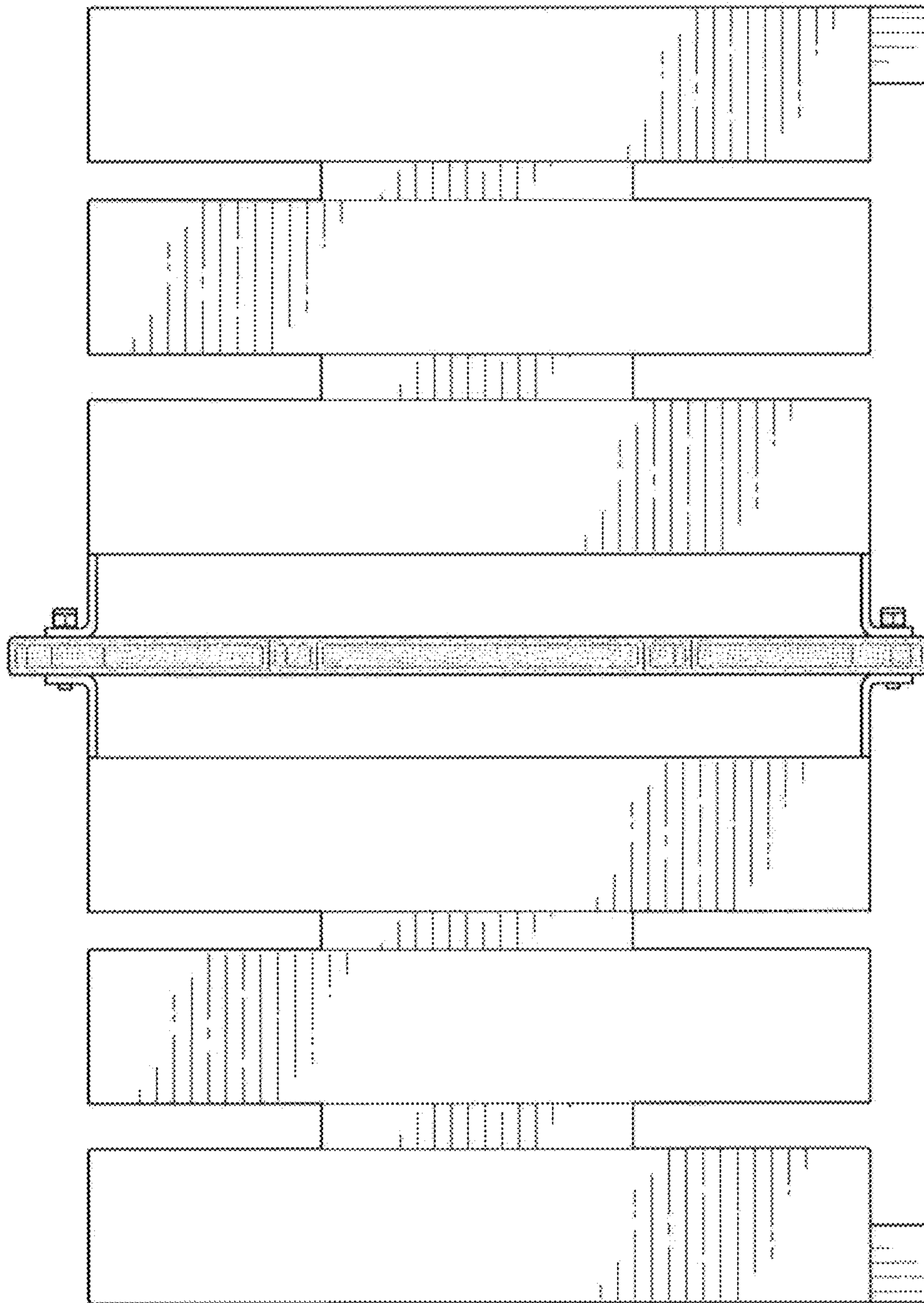

FIG. 6

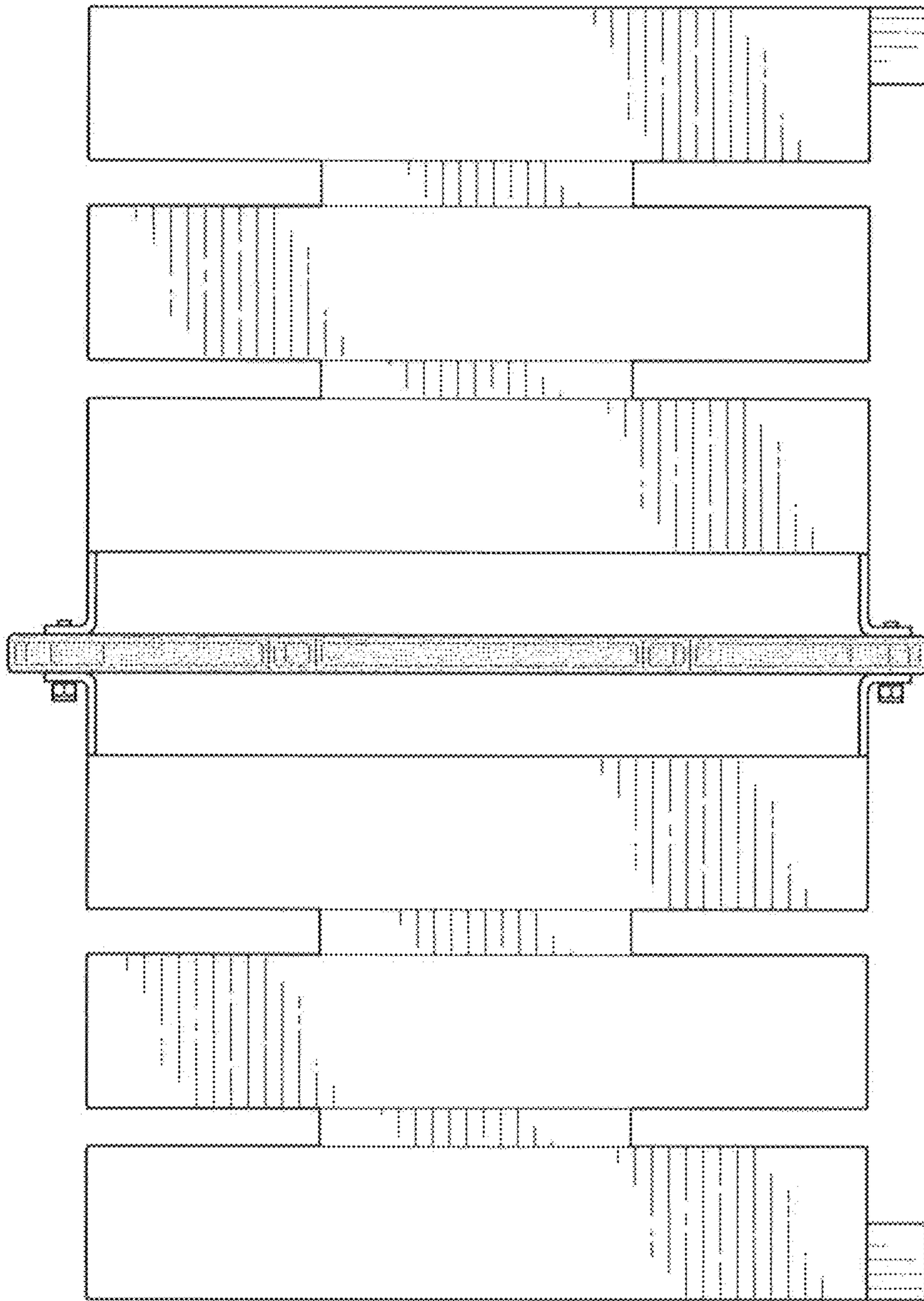

FIG. 7

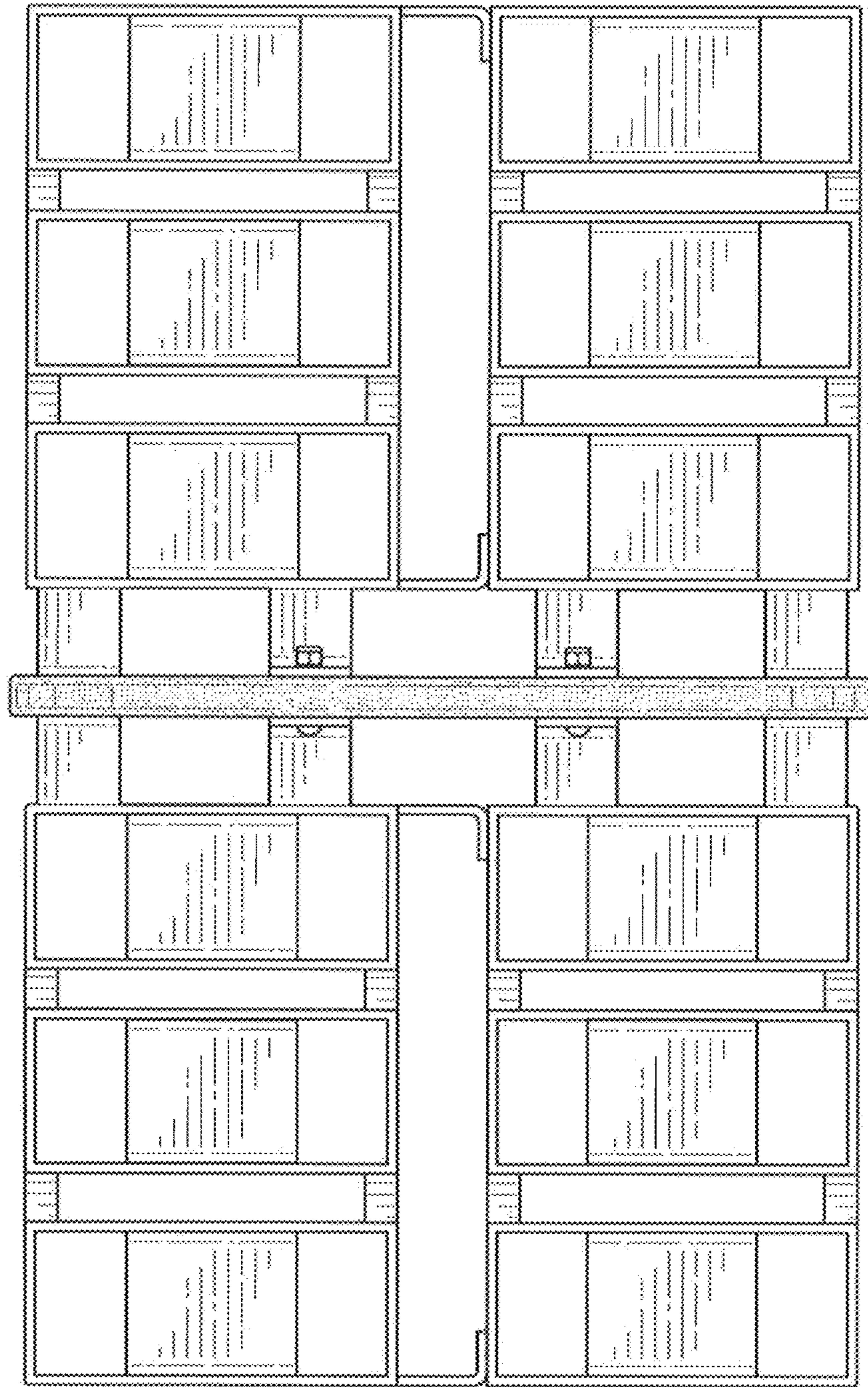

FIG. 8

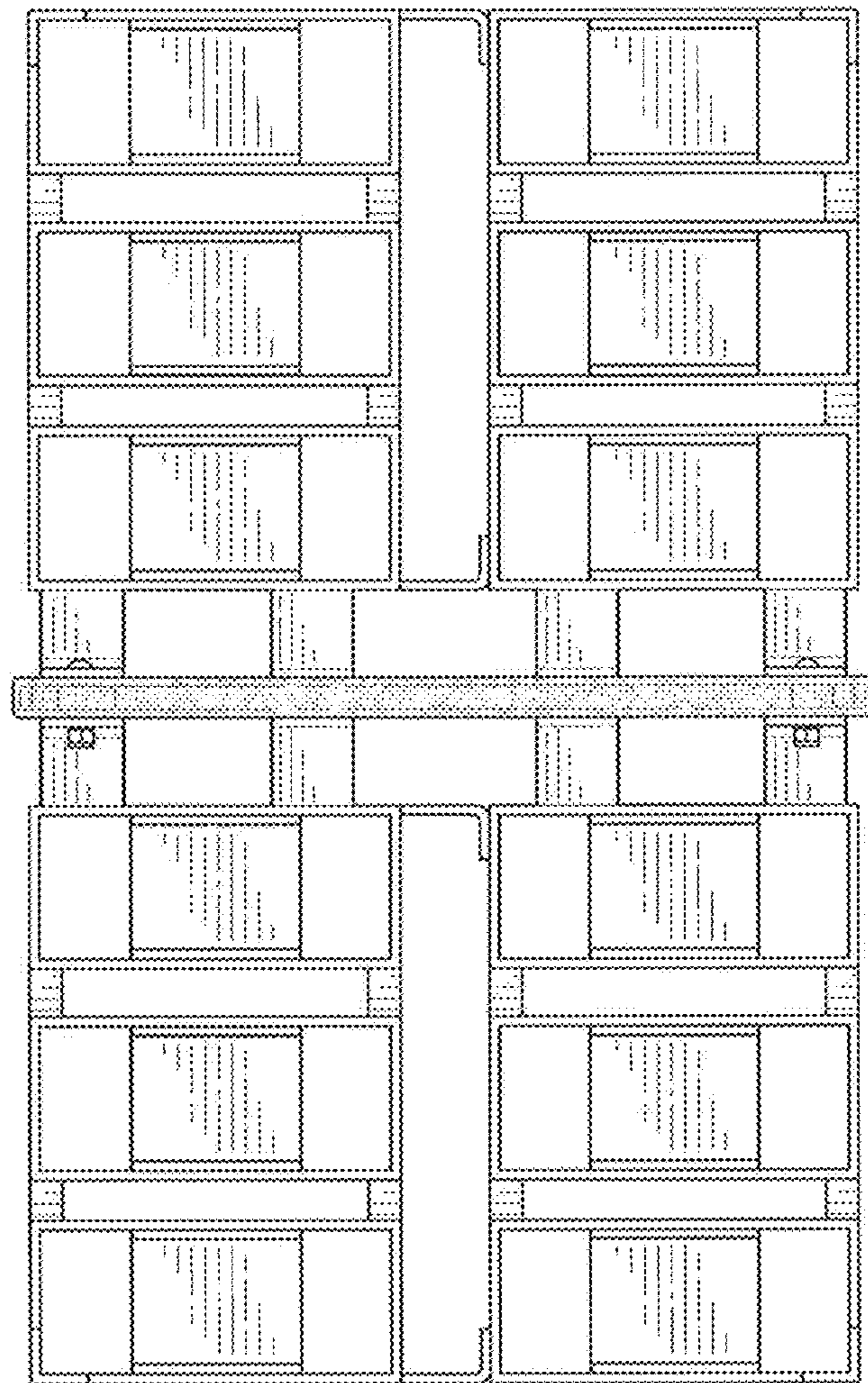

FIG. 9