



US00D800316S

(12) **United States Design Patent** (10) **Patent No.:** **US D800,316 S**  
**Evers** (45) **Date of Patent:** **\*\* Oct. 17, 2017**

(54) **CAPSULE**

**DESCRIPTION**

(71) Applicant: **DENTSPLY DETREY GMBH**,  
Constance (DE)  
(72) Inventor: **Markus Evers**, Constance (DE)  
(73) Assignee: **Dentsply Sirona Inc.**, York, PA (US)  
(\*\*) Term: **15 Years**  
(21) Appl. No.: **35/500,657**  
(22) Filed: **Sep. 1, 2015**  
(80) **Hague Agreement Data**  
Int. Filing Date: **Sep. 1, 2015**  
Int. Reg. No.: **DM/088106**  
Int. Reg. Date: **Sep. 1, 2015**  
Int. Reg. Pub. Date: **Mar. 4, 2016**

The file of this patent contains at least one drawing/photograph executed in color. Copies of this patent with color drawing(s)/photograph(s) will be provided by the Office upon request and payment of the necessary fee.

(30) **Foreign Application Priority Data**

Mar. 2, 2015 (EM) ..... 002644286-0001-0005

(51) **LOC (10) Cl.** ..... **24-00**  
(52) **U.S. Cl.**  
USPC ..... **D24/176**

(58) **Field of Classification Search**  
USPC ..... D24/176, 130, 152, 217, 224; D9/447,  
D9/453; 206/219; 433/90

(Continued)

(56) **References Cited**

**U.S. PATENT DOCUMENTS**

D243,628 S \* 3/1977 Biondo ..... D24/224  
D258,762 S \* 3/1981 Corrigan ..... 206/219  
(Continued)

*Primary Examiner* — Rhea Shields

(74) *Attorney, Agent, or Firm* — Leana Levin; Douglas J. Hura; David A. Zdurne

(57) **CLAIM**

The ornamental design for a capsule, as shown and described.

- 1.1 is a side view;
- 1.2 is a front view;
- 1.3 is a rear view;
- 1.4 is a top view;
- 1.5 is a bottom view;
- 1.6 is another side view, and
- 1.7 is a perspective view.
- 2.1 is a side view;
- 2.2 is a front view;
- 2.3 is a rear view;
- 2.4 is a top view;
- 2.5 is a bottom view;
- 2.6 is another side view, and
- 2.7 is a perspective view.
- 3.1 is a side view;
- 3.2 is a front view;
- 3.3 is a rear view;
- 3.4 is a top view;
- 3.5 is a bottom view;
- 3.6 is another side view, and
- 3.7 is a perspective view.
- 4.1 is a side view;
- 4.2 is a front view;
- 4.3 is a rear view;
- 4.4 is a top view;
- 4.5 is a bottom view;
- 4.6 is another side view, and
- 4.7 is a perspective view.
- 5.1 is a side view;
- 5.2 is a front view;
- 5.3 is a rear view;
- 5.4 is a top view;
- 5.5 is a bottom view;
- 5.6 is another side view, and
- 5.7 is a perspective view.

**1 Claim, 35 Drawing Sheets**  
**(35 of 35 Drawing Sheet(s) Filed in Color)**

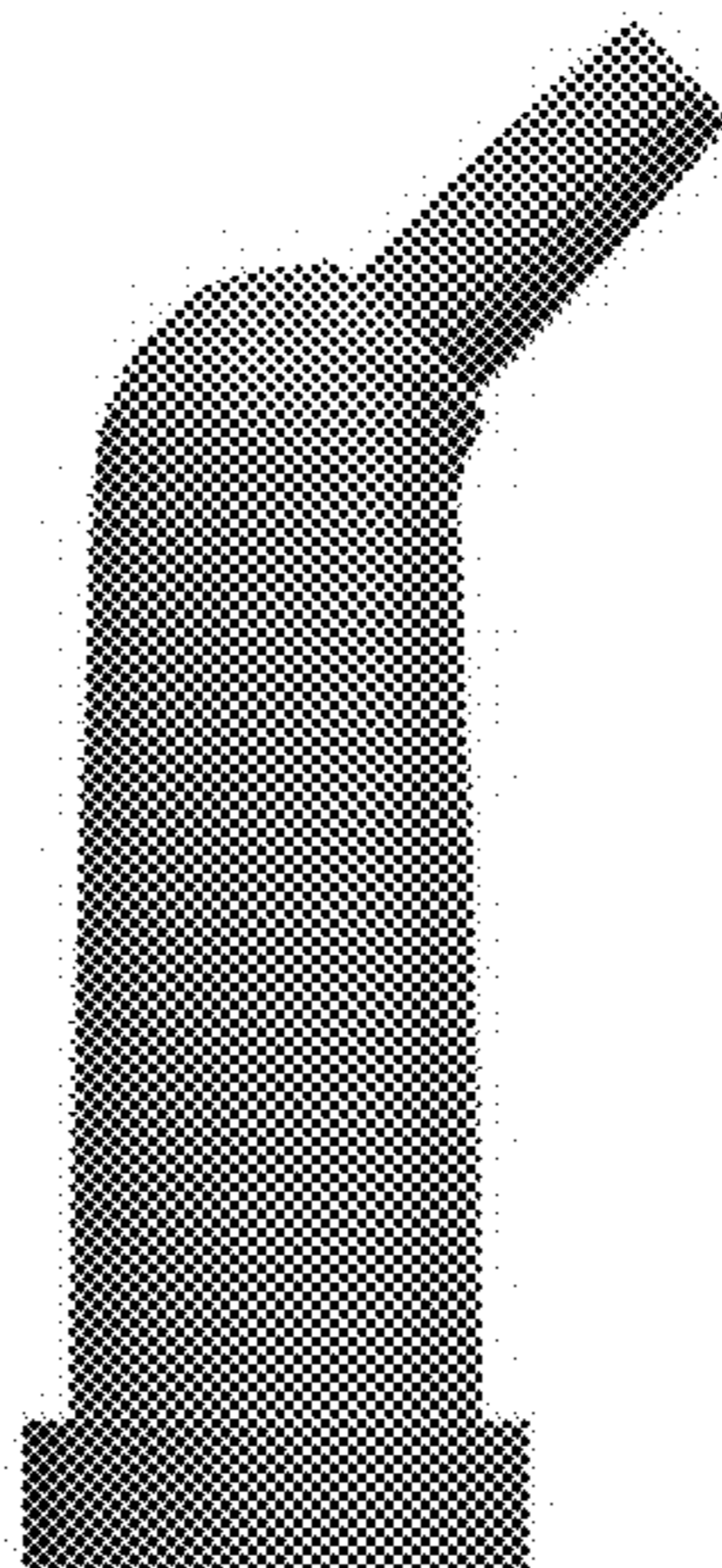

(58) **Field of Classification Search**

CPC ..... A61C 5/062

See application file for complete search history.

(56) **References Cited**

U.S. PATENT DOCUMENTS

4,391,590 A \* 7/1983 Dougherty ..... A61C 5/062  
433/90  
D292,528 S \* 10/1987 Weissenburger ..... D24/224  
D594,132 S \* 6/2009 Cheetham ..... D24/224  
D602,591 S \* 10/2009 Cheetham ..... D24/176  
D602,592 S \* 10/2009 Cheetham ..... D24/176  
D602,593 S \* 10/2009 Cheetham ..... D24/176  
D619,720 S \* 7/2010 Cheetham ..... D24/176  
D620,118 S \* 7/2010 Cheetham ..... D24/176  
D644,328 S \* 8/2011 Pauser ..... D24/176  
D657,877 S \* 4/2012 Pauser ..... D24/176  
D658,763 S \* 5/2012 Peuker ..... D24/176  
D702,834 S \* 4/2014 Norton ..... D24/130  
D705,426 S \* 5/2014 Fiorina ..... D24/152  
D707,363 S \* 6/2014 Wen ..... D24/217  
D747,799 S \* 1/2016 Norton ..... D24/130  
D754,539 S \* 4/2016 Eckstein ..... D9/447  
D770,287 S \* 11/2016 Holaschke ..... D9/453

\* cited by examiner

**1.1**

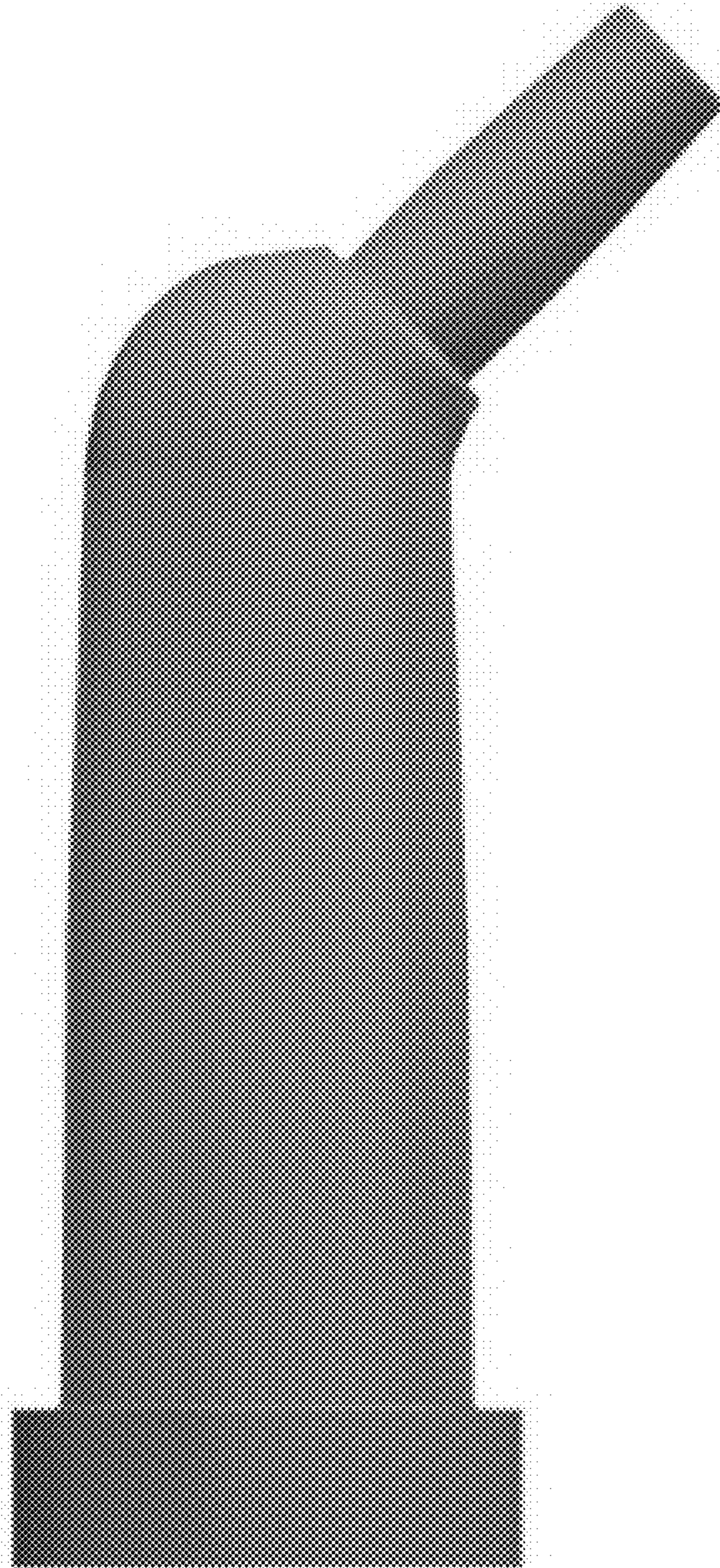

**1.2**

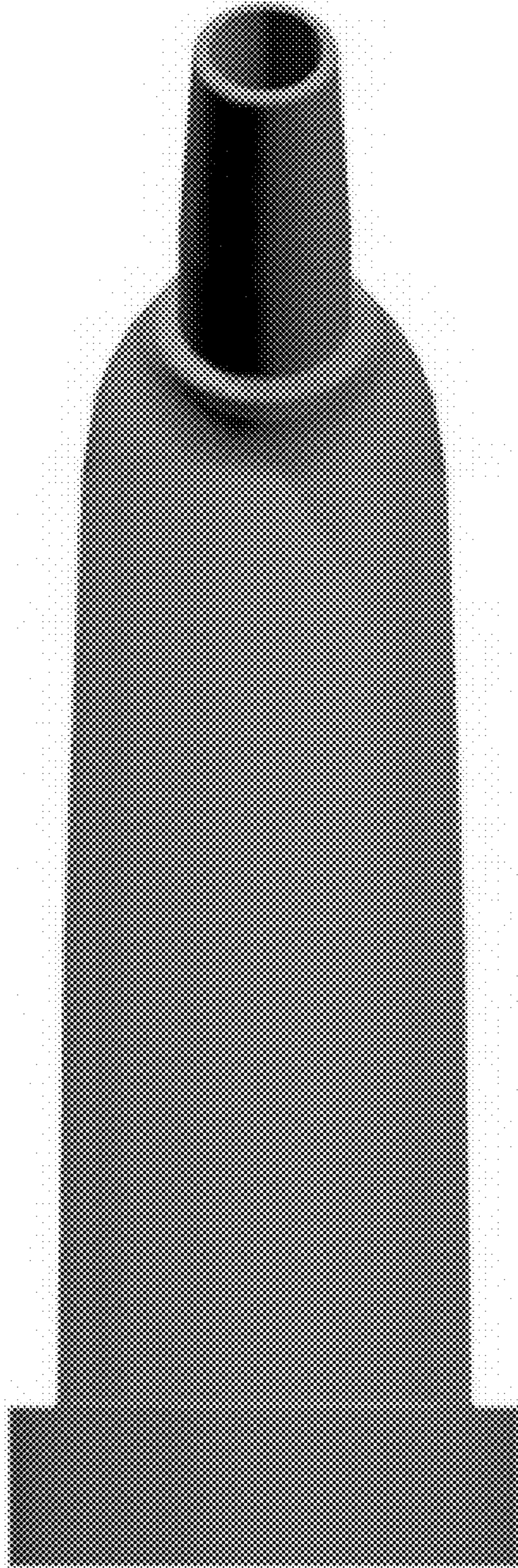

**1.3**

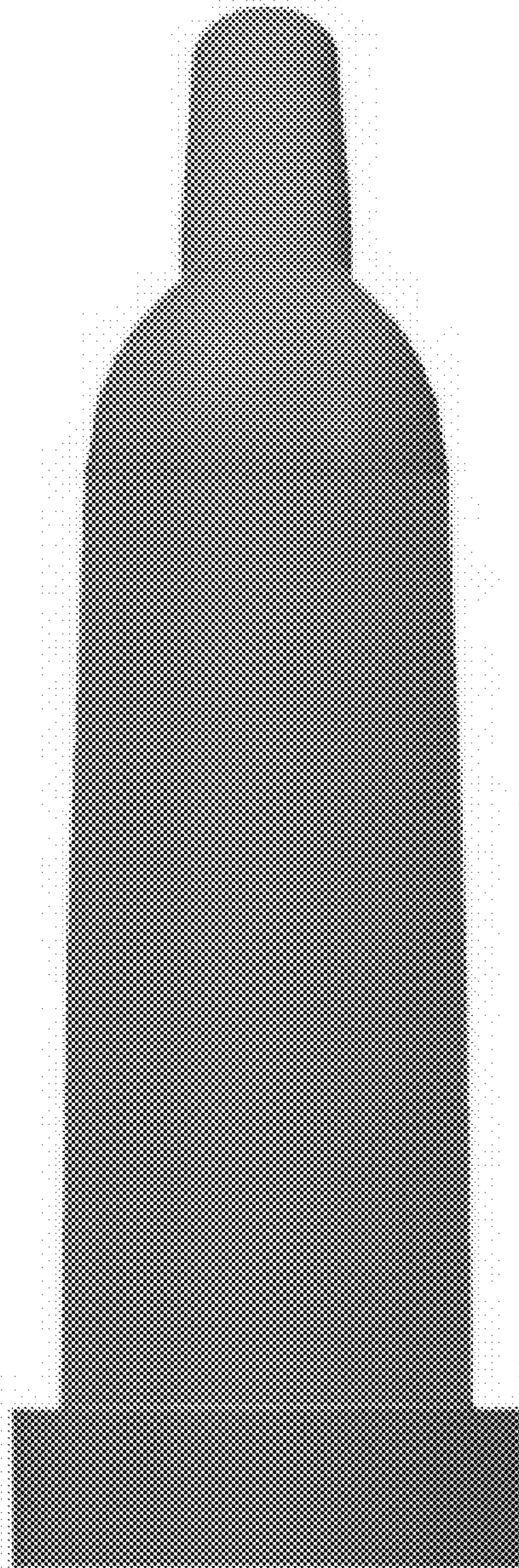

**1.4**

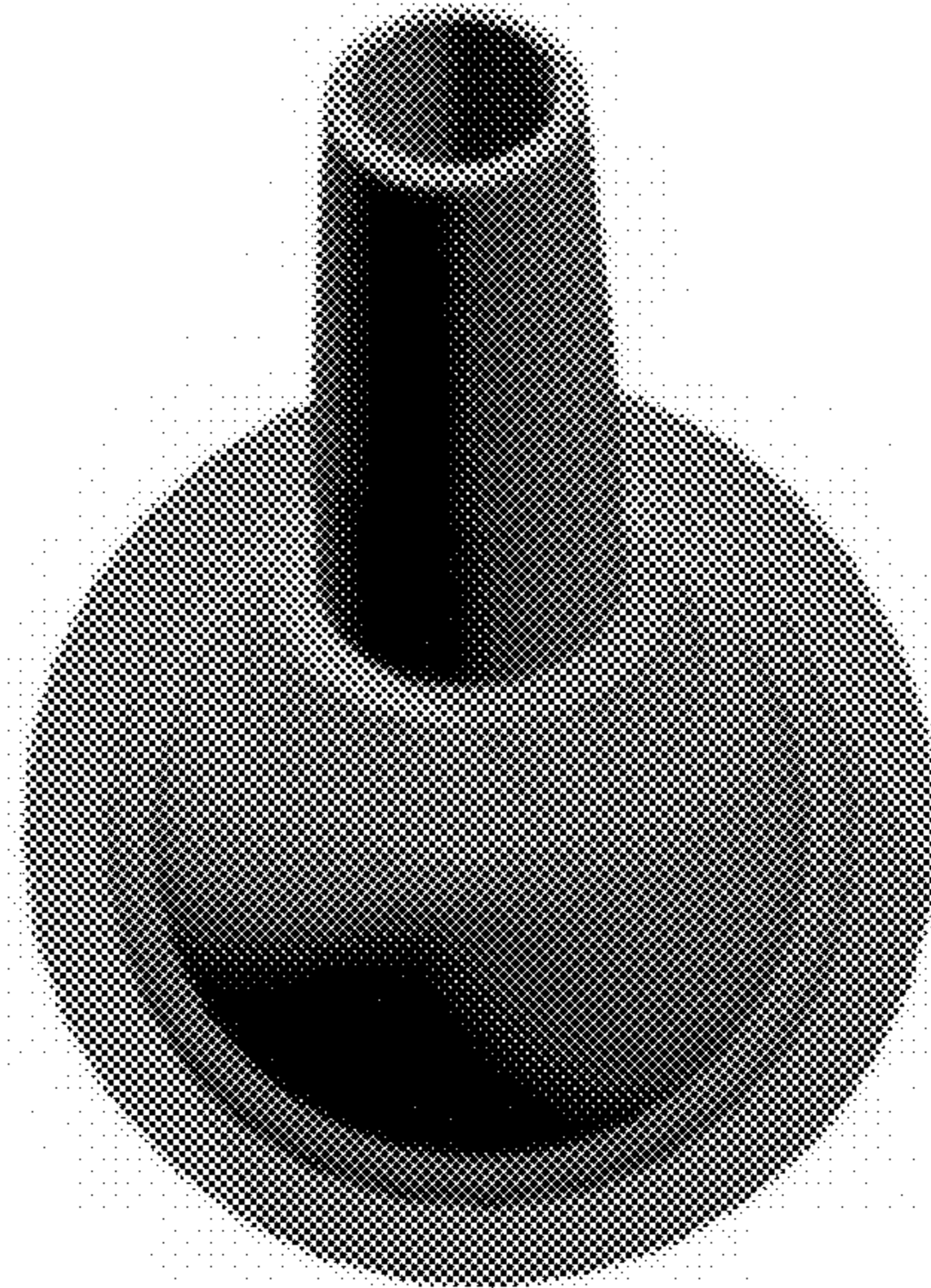

**1.5**

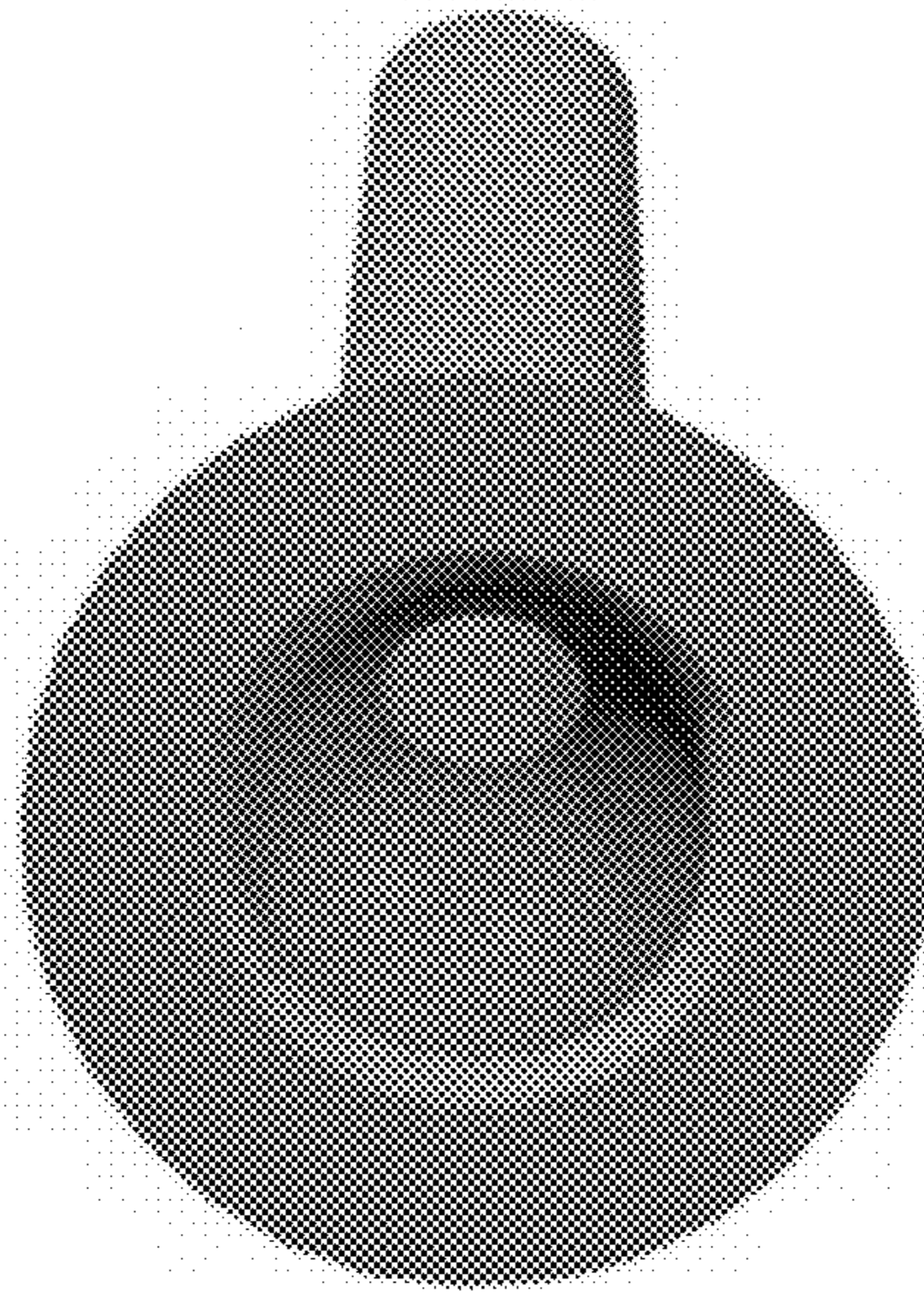

**1.6**

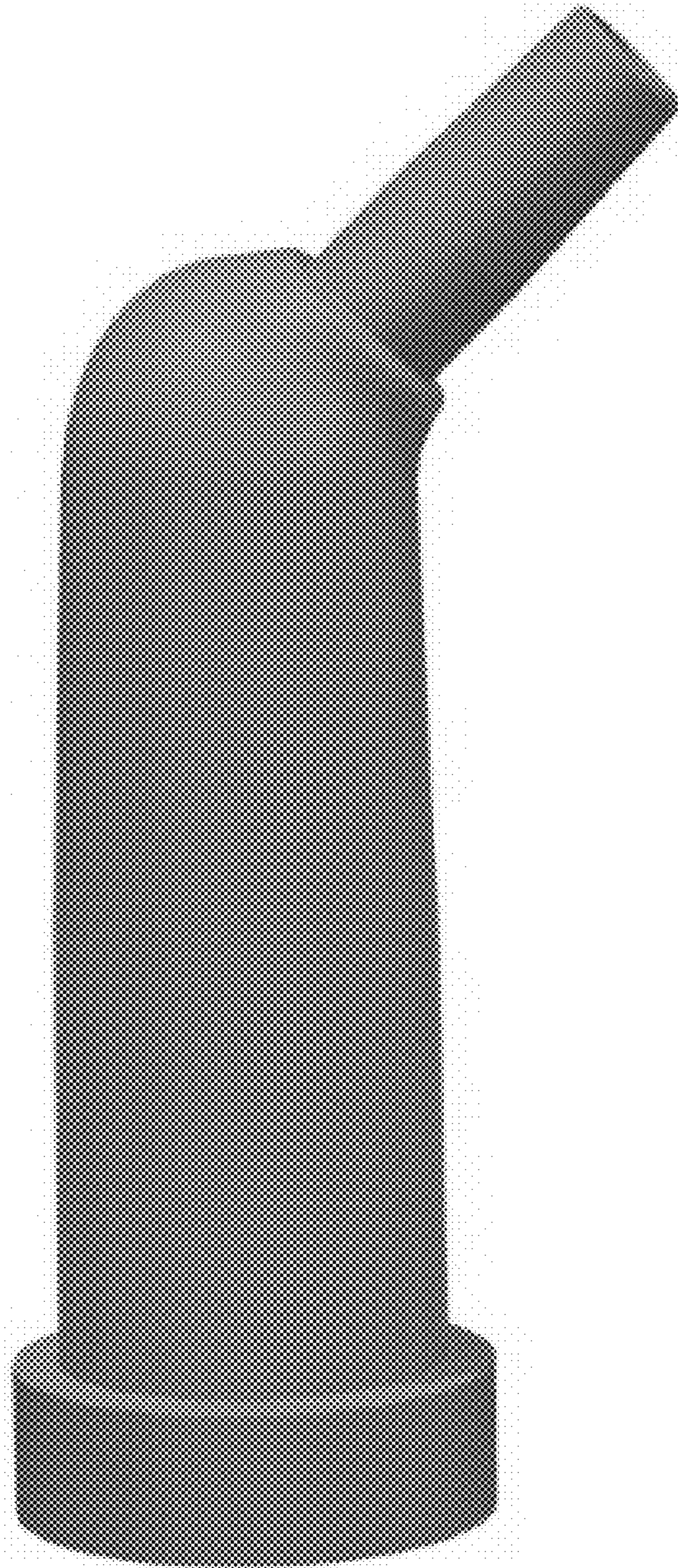



**1.7**

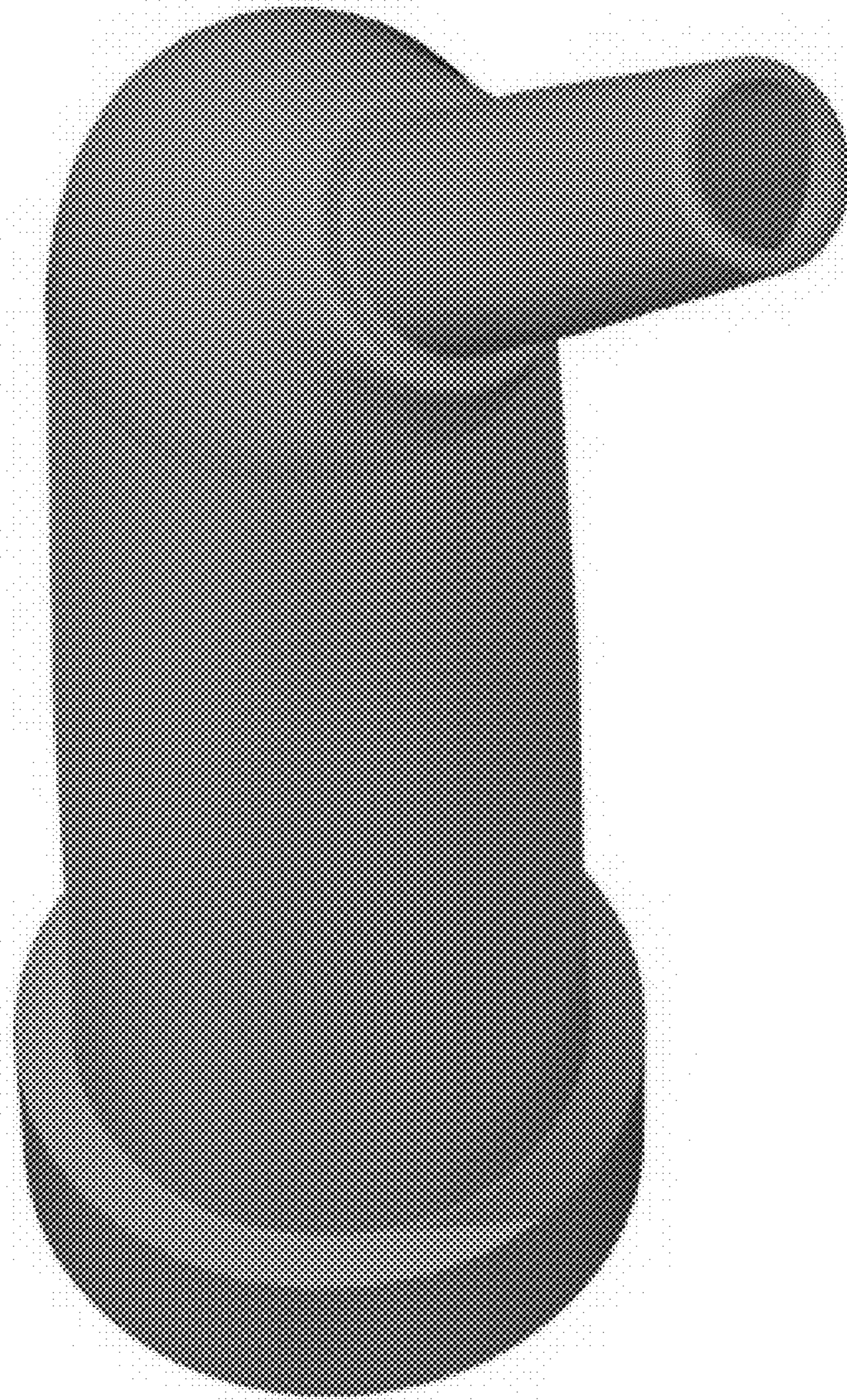

## 2.1



**2.2**

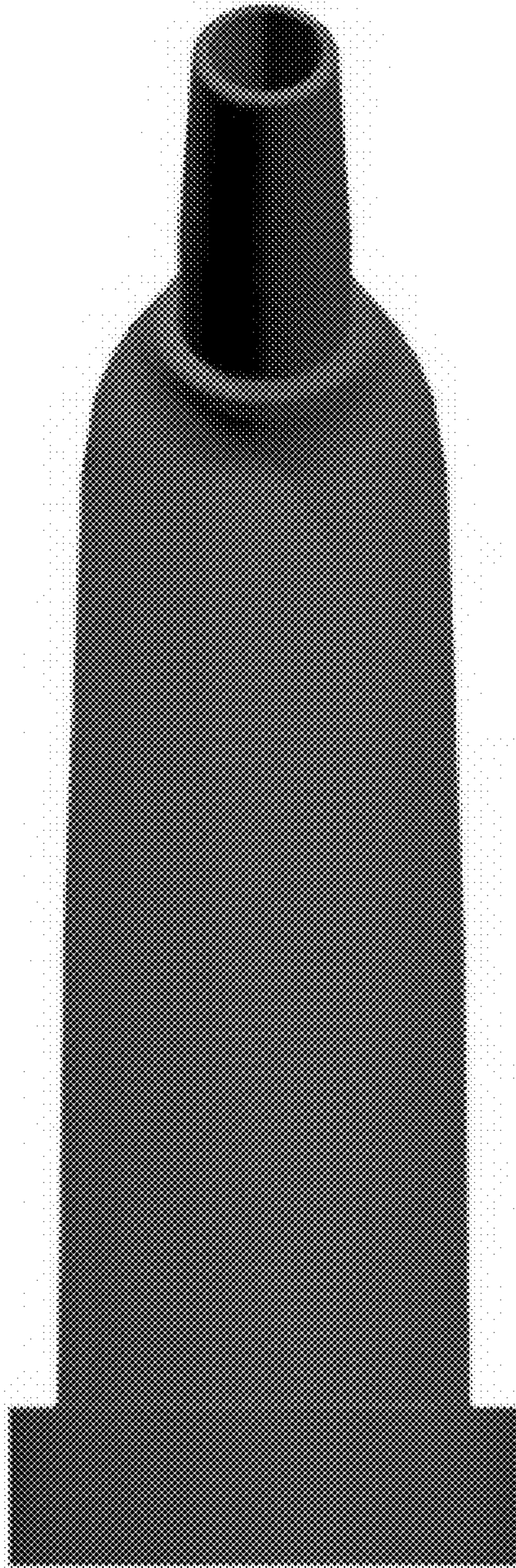

**2.3**

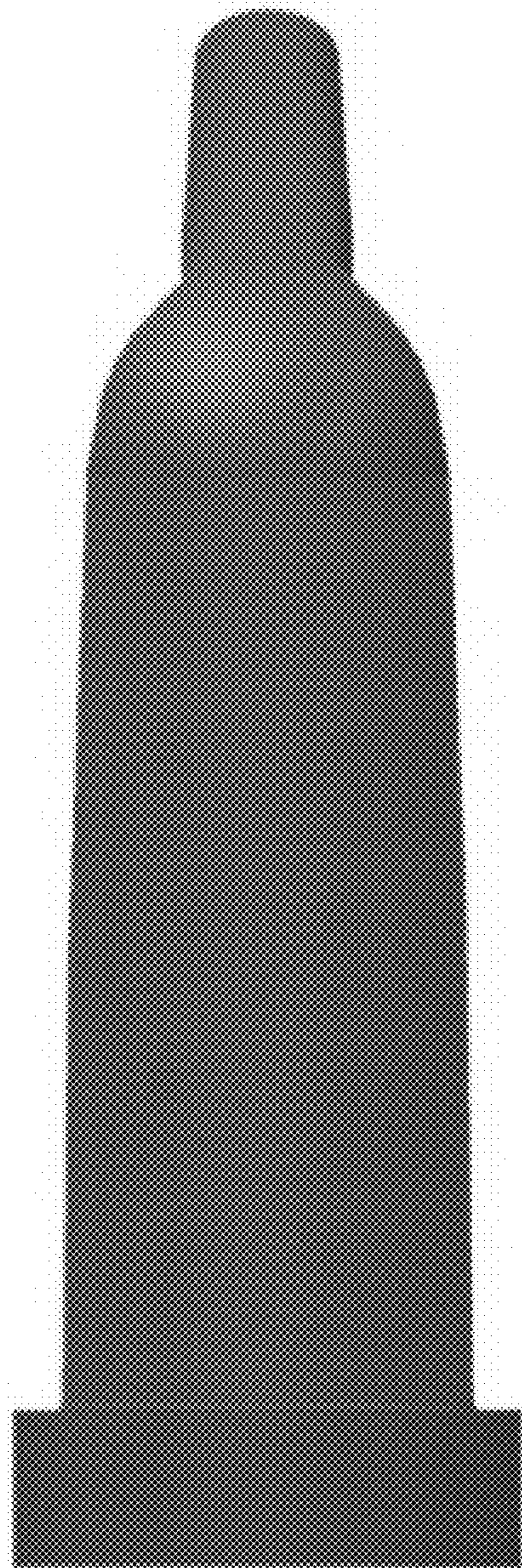

**2.4**

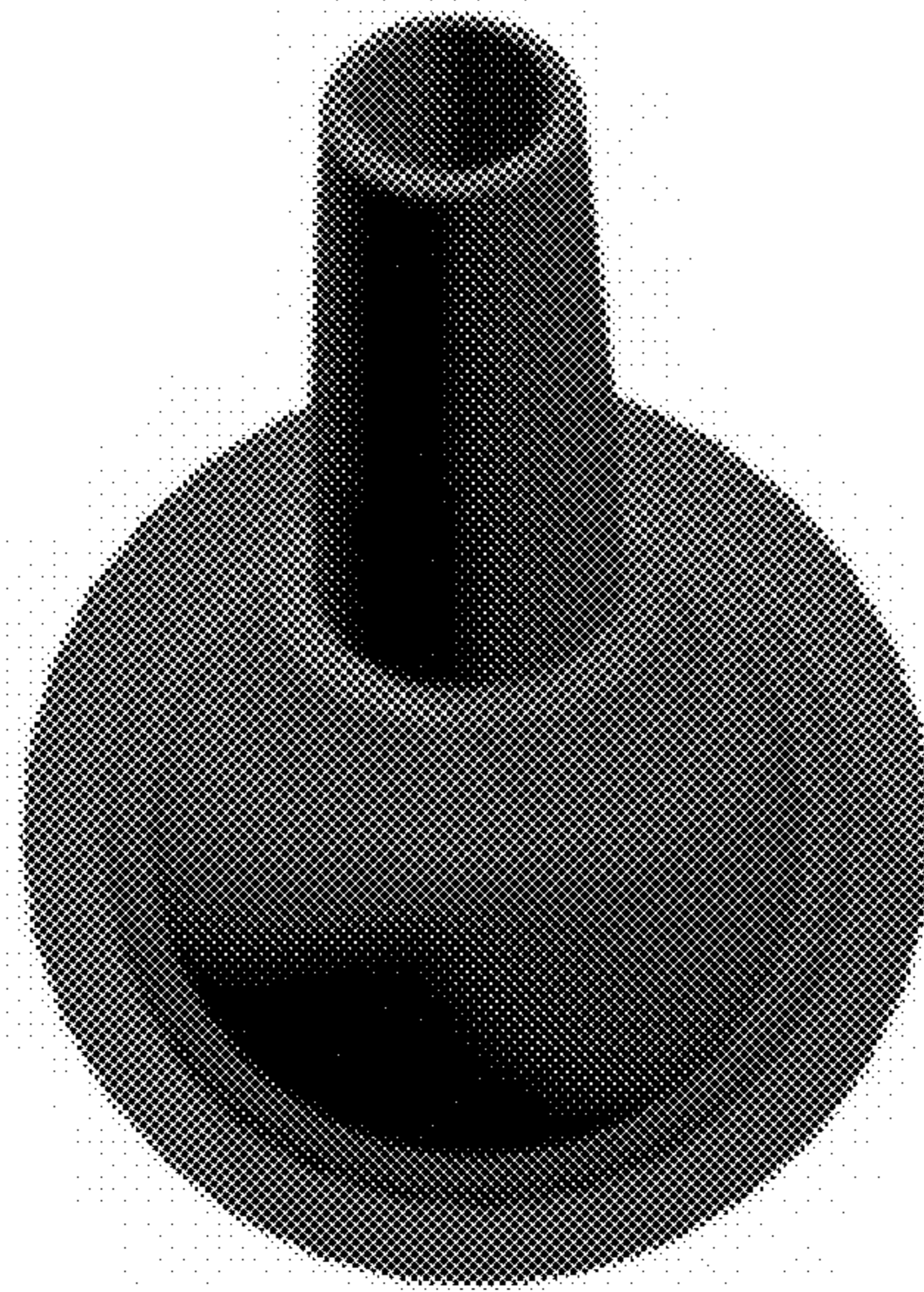

**2.5**

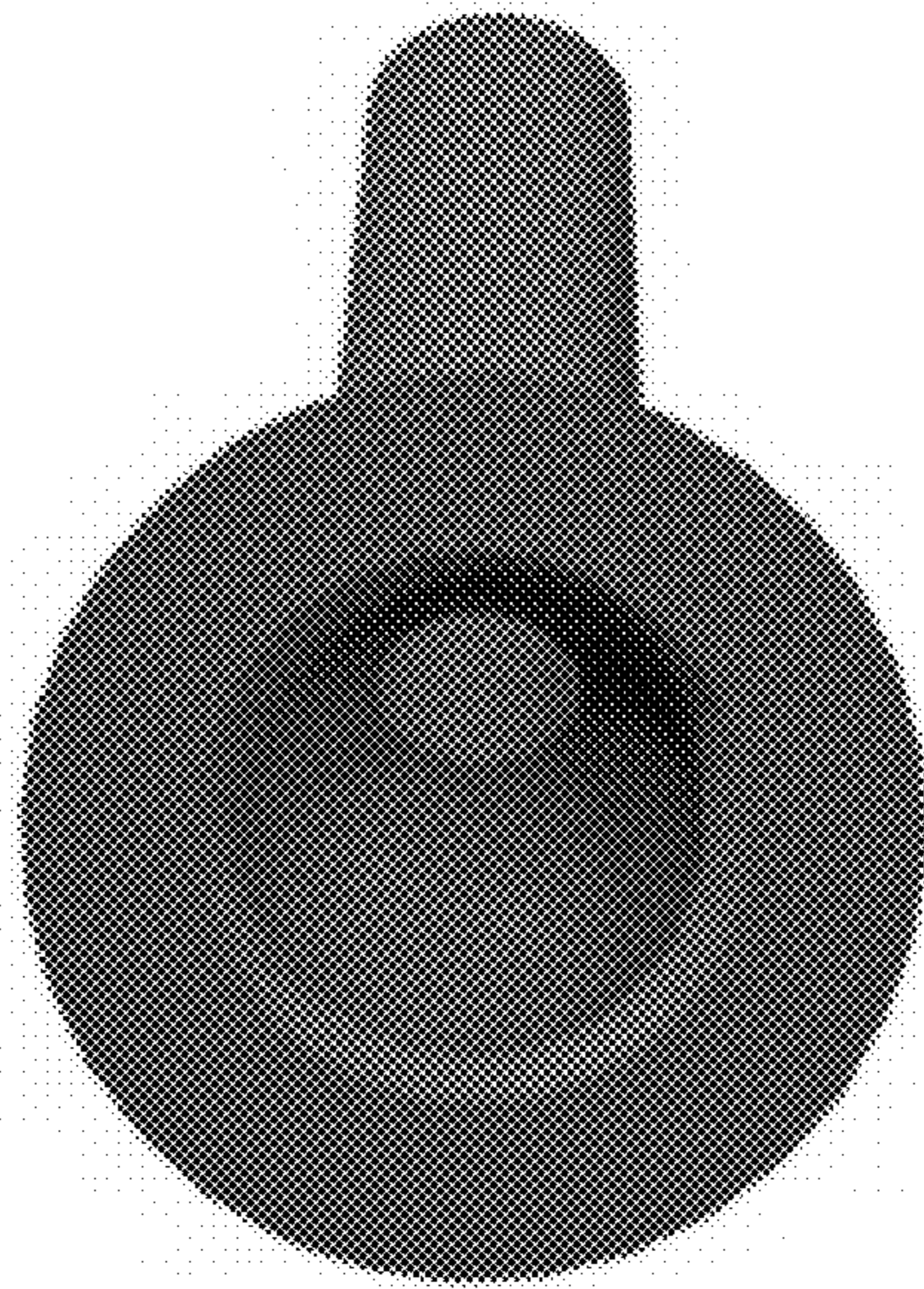

**2.6**

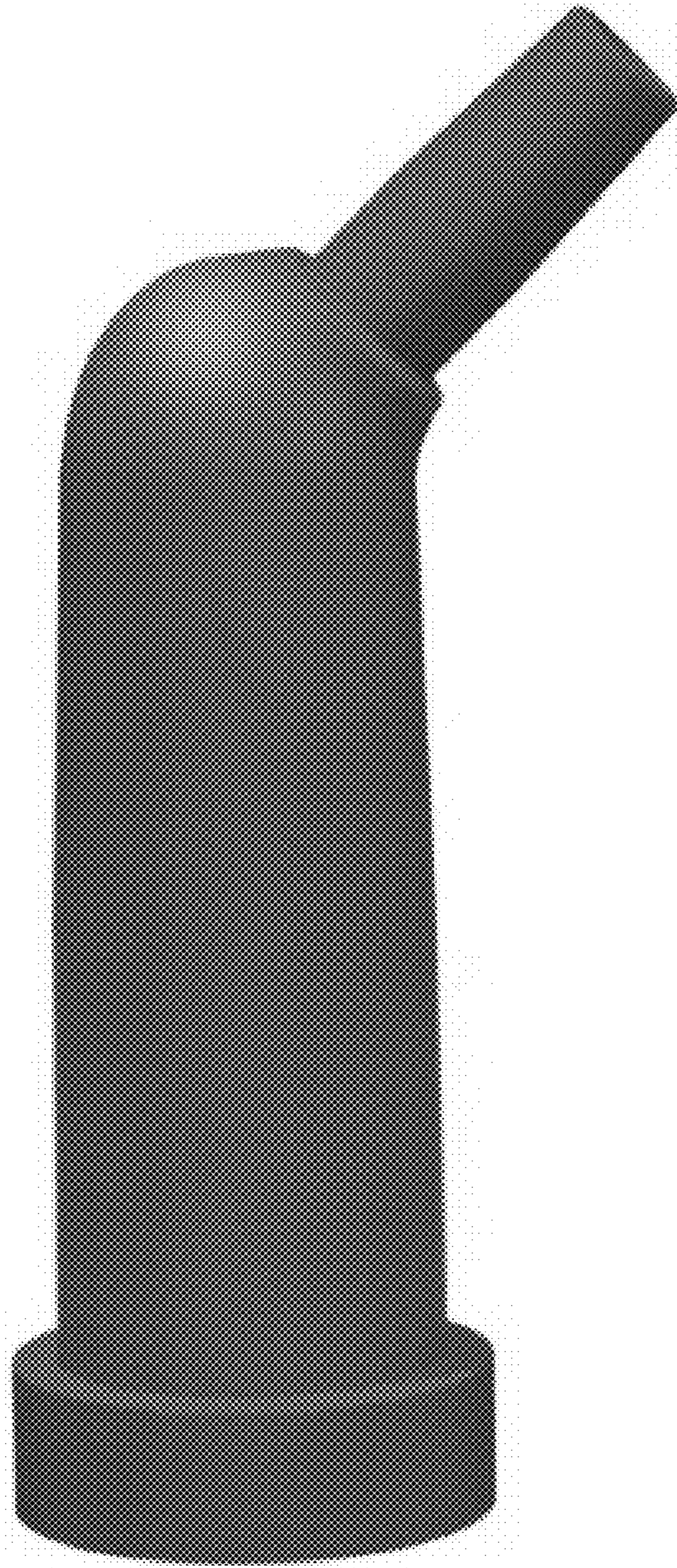

**2.7**

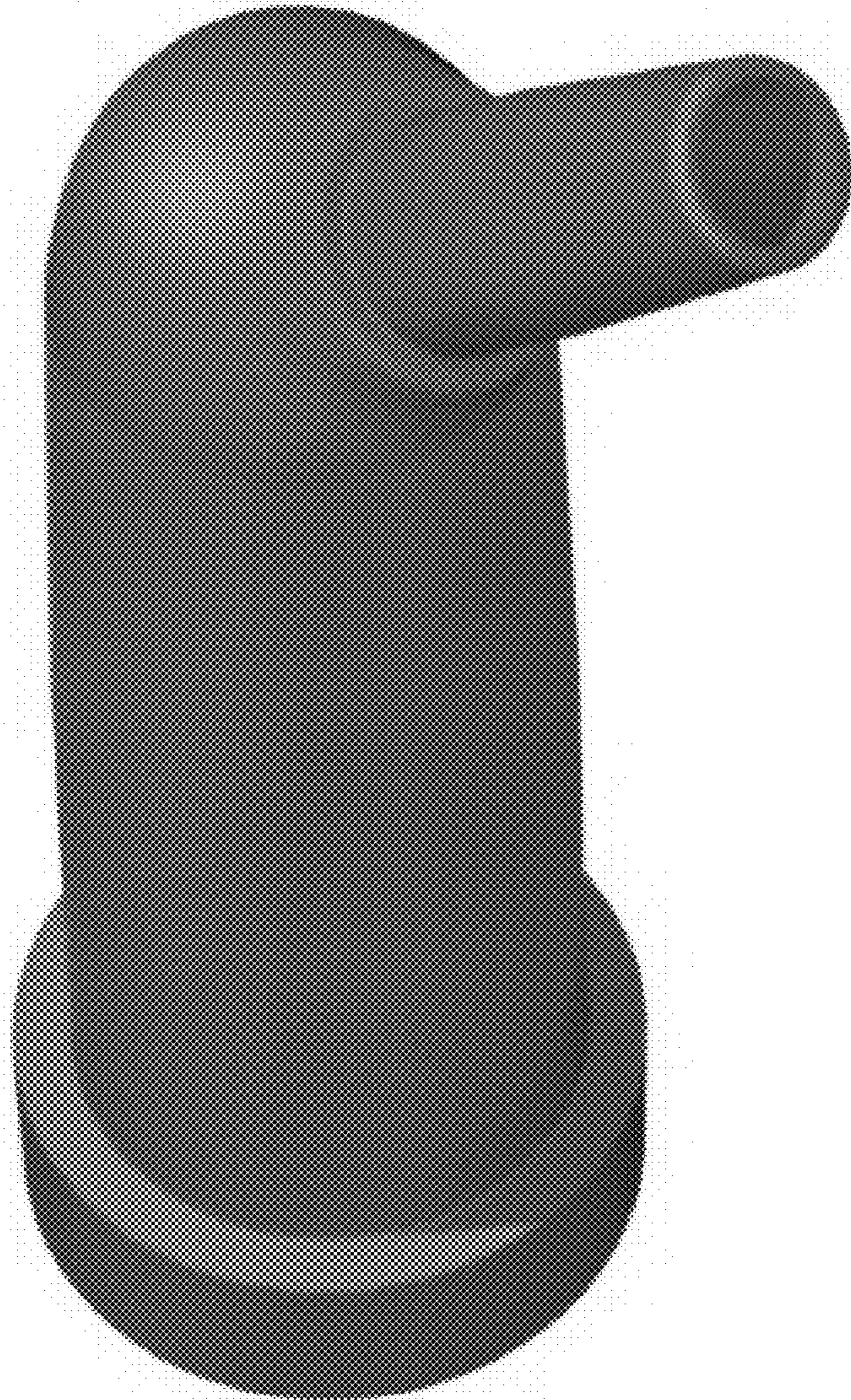



# 3.1

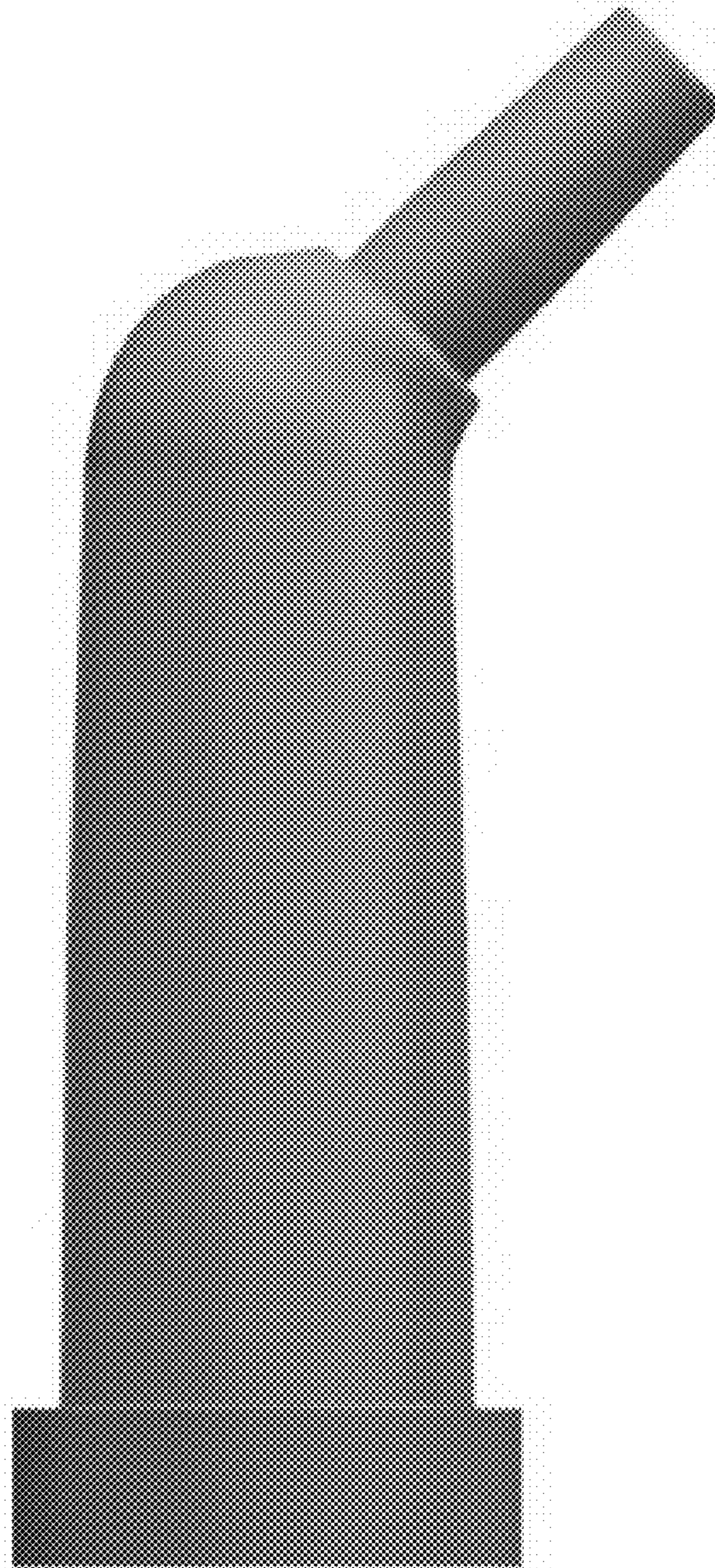

**3.2**

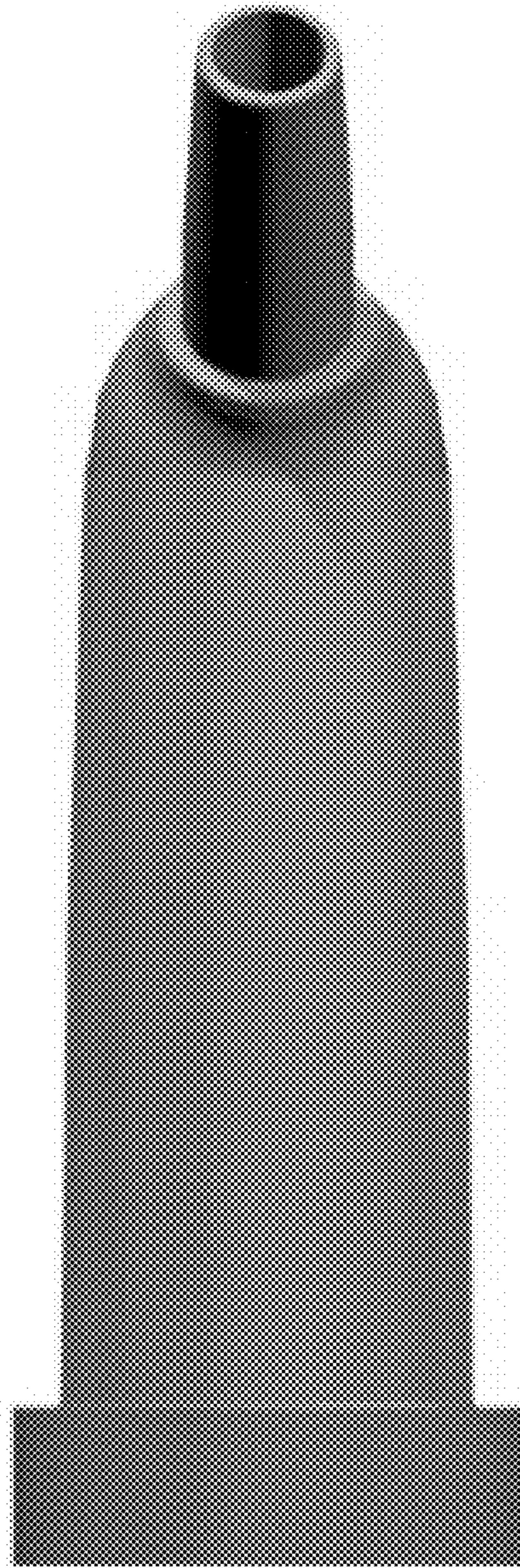

**3.3**

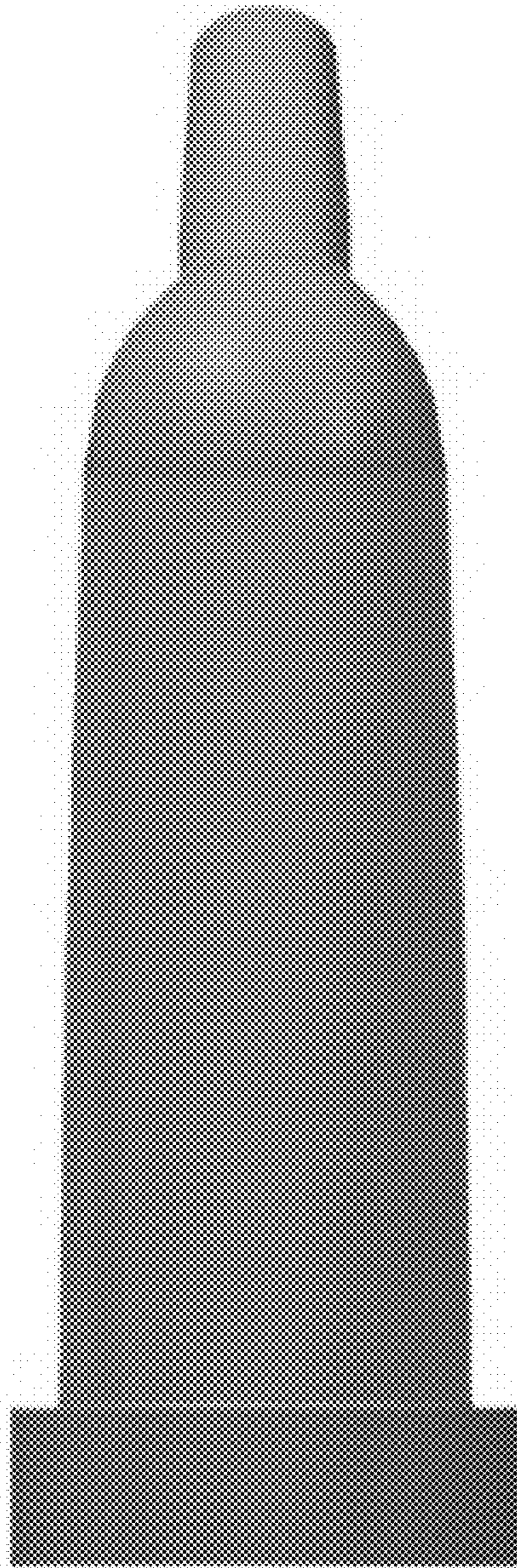

**3.4**

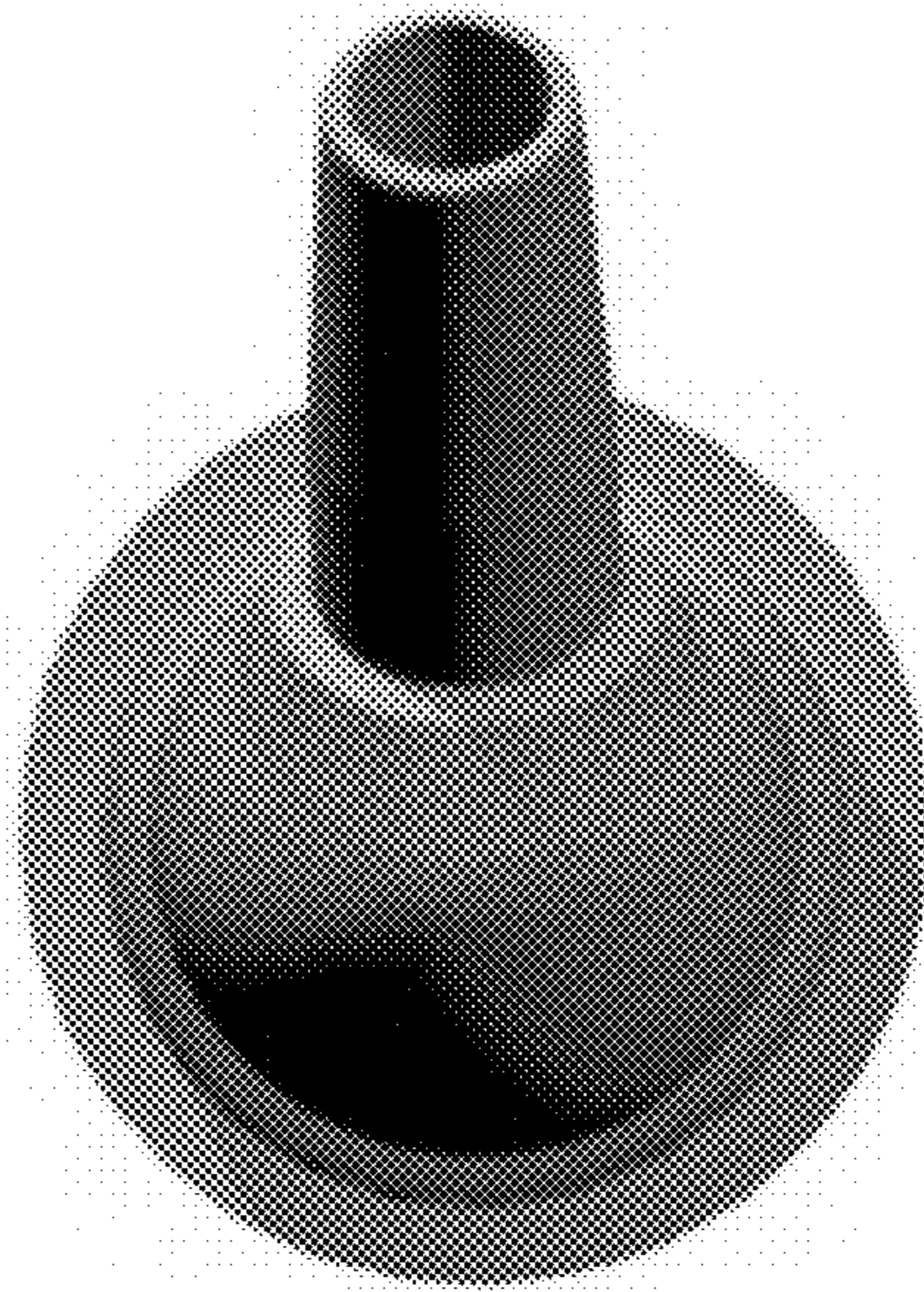

**3.5**

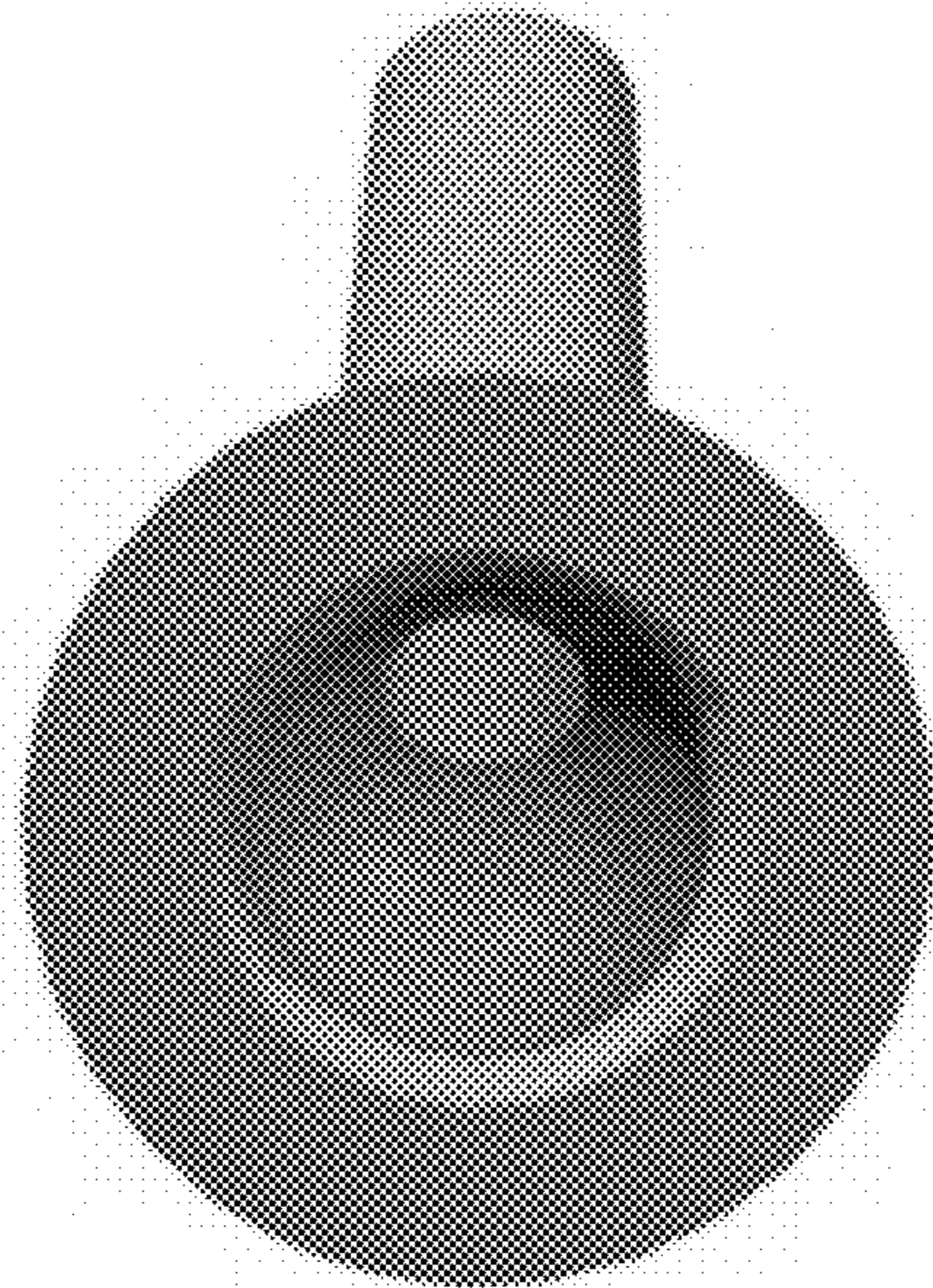

**3.6**

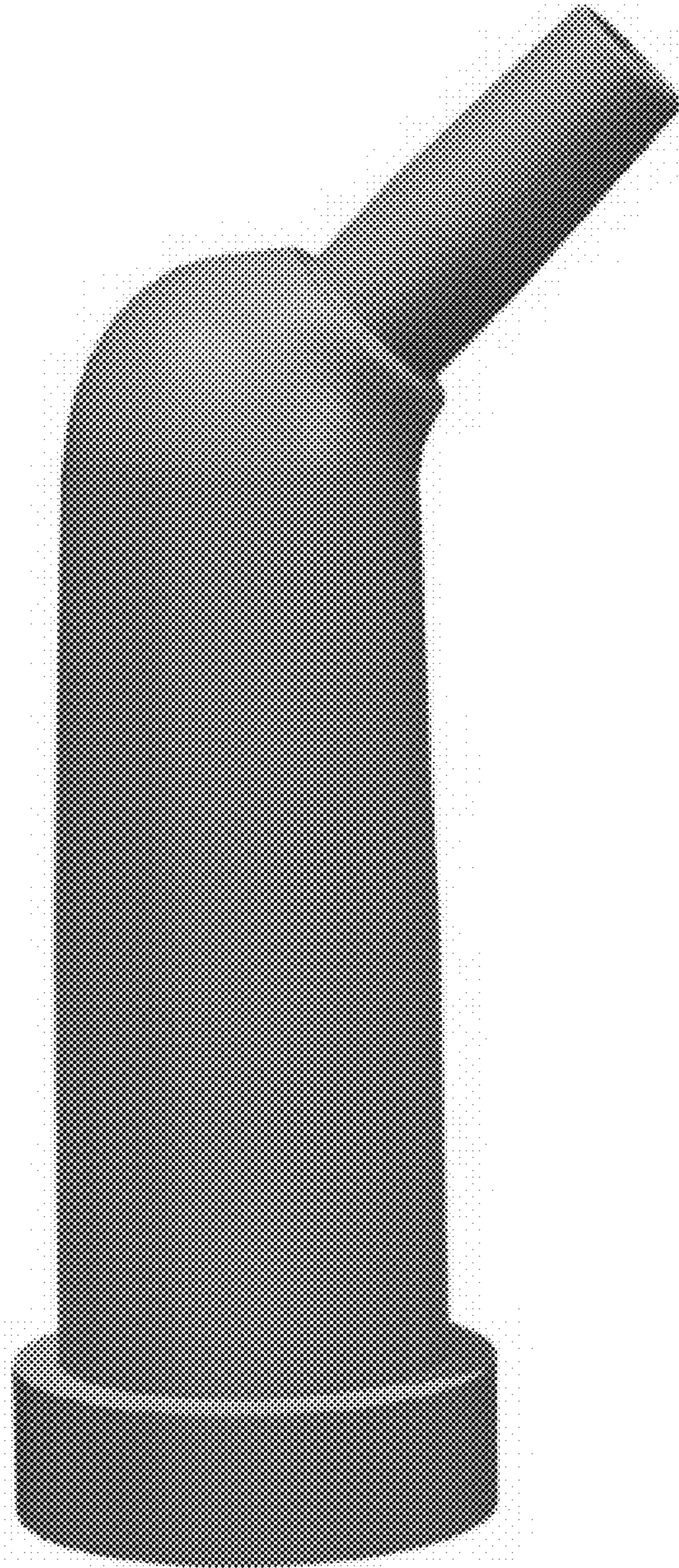

**3.7**

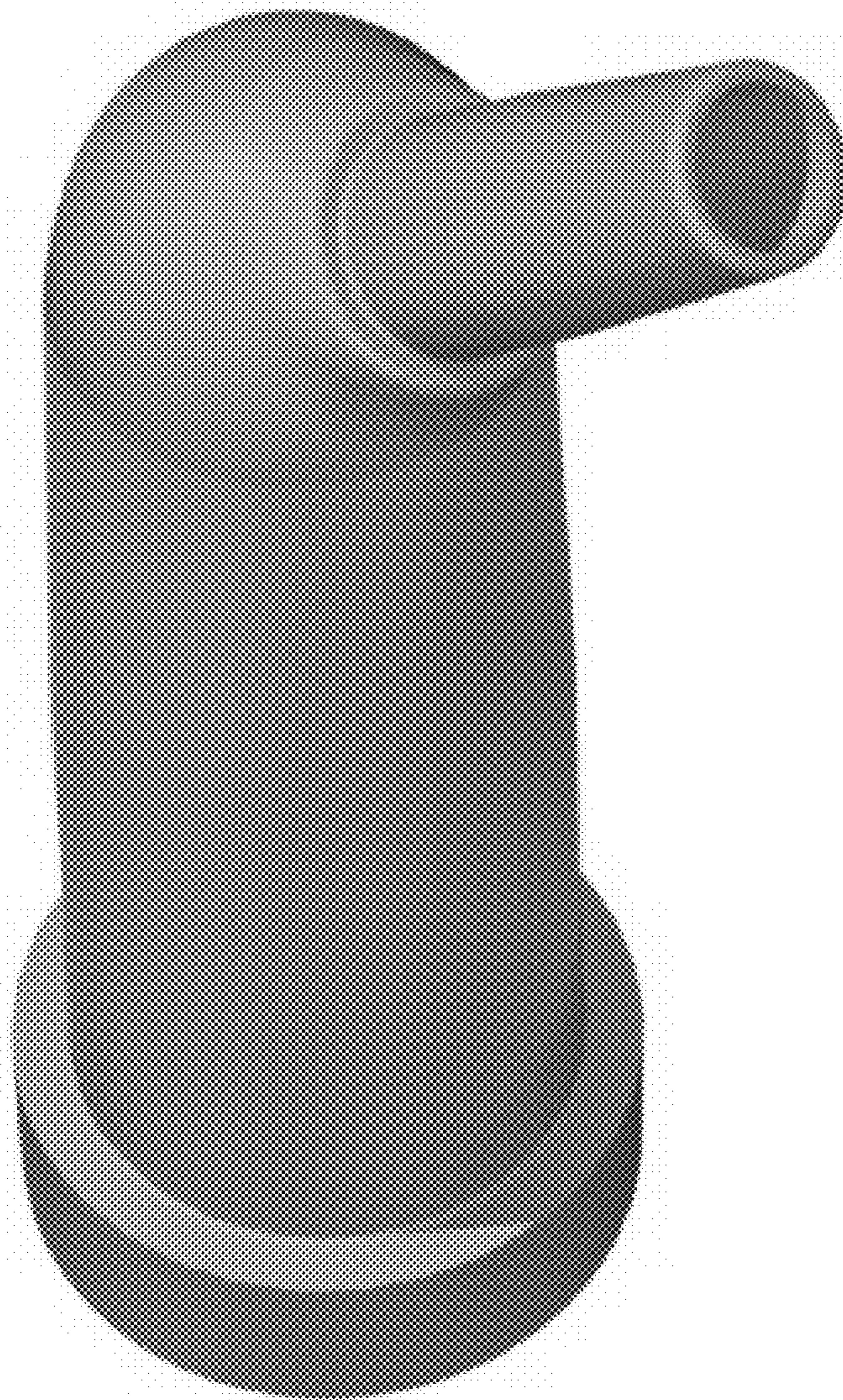

# 4.1

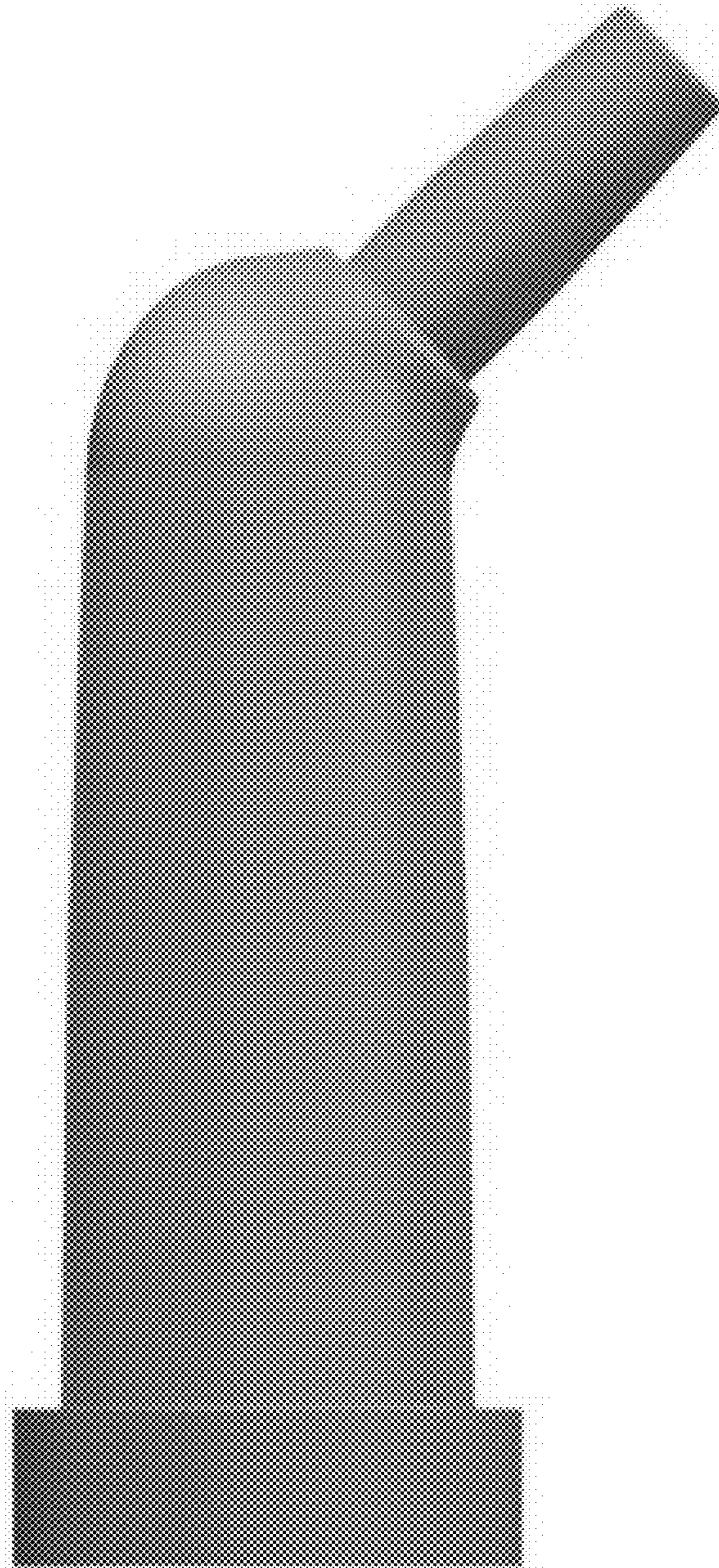



**4.2**

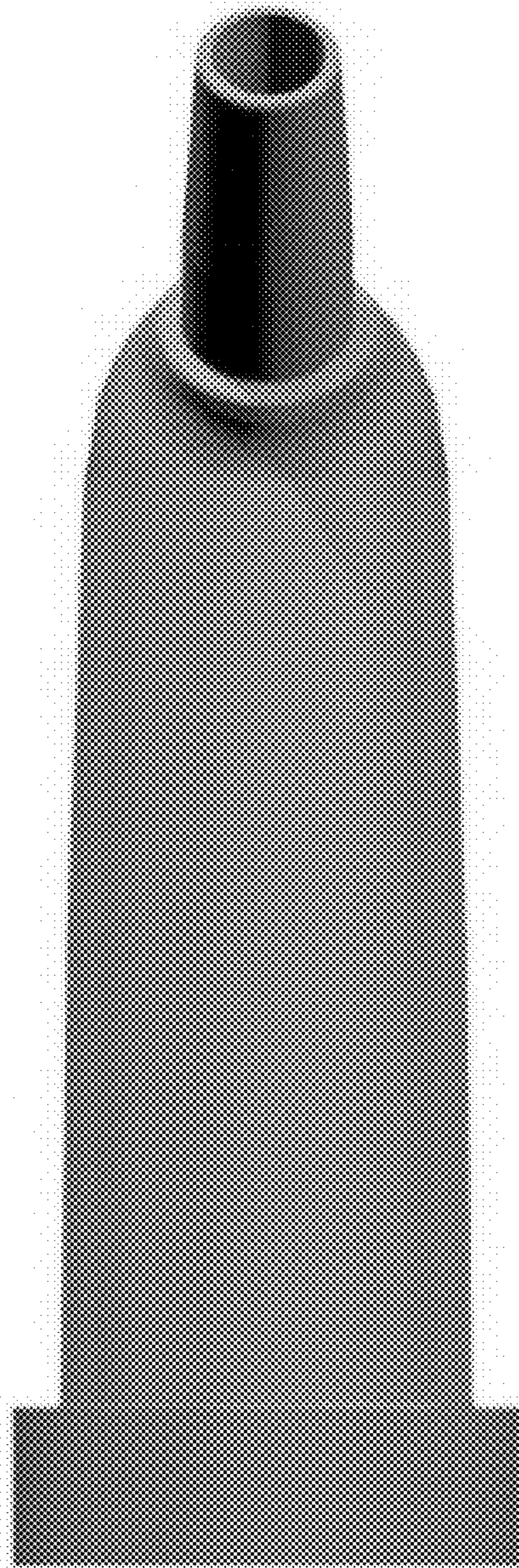

**4.3**

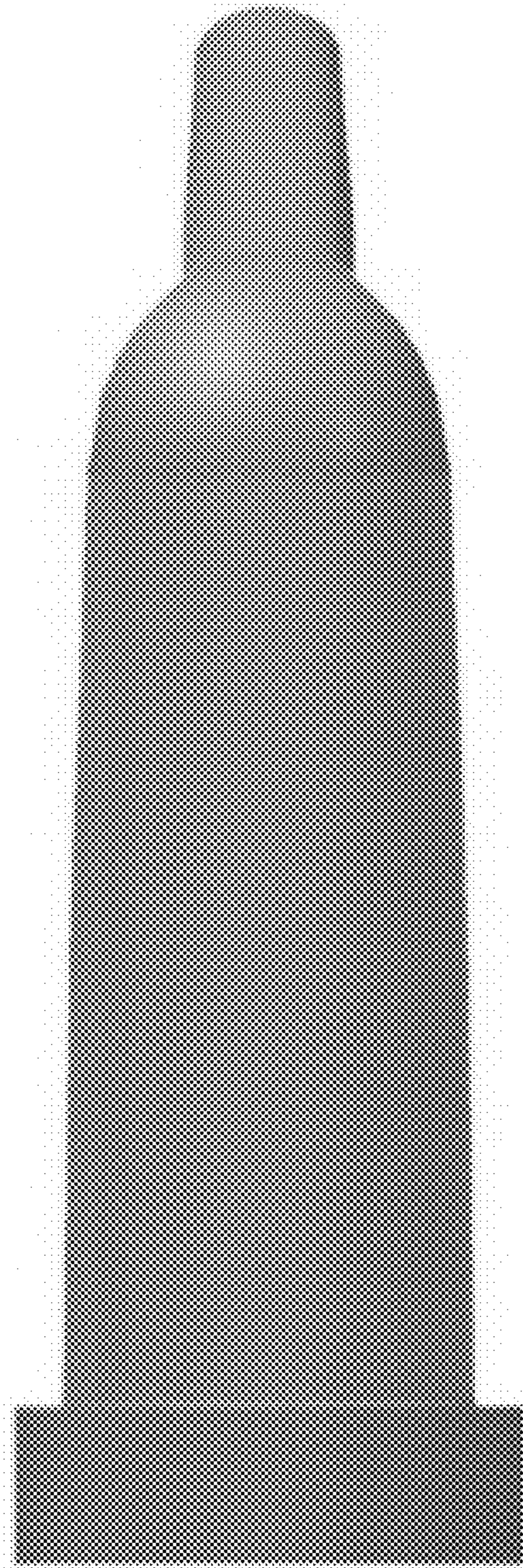

**4.4**

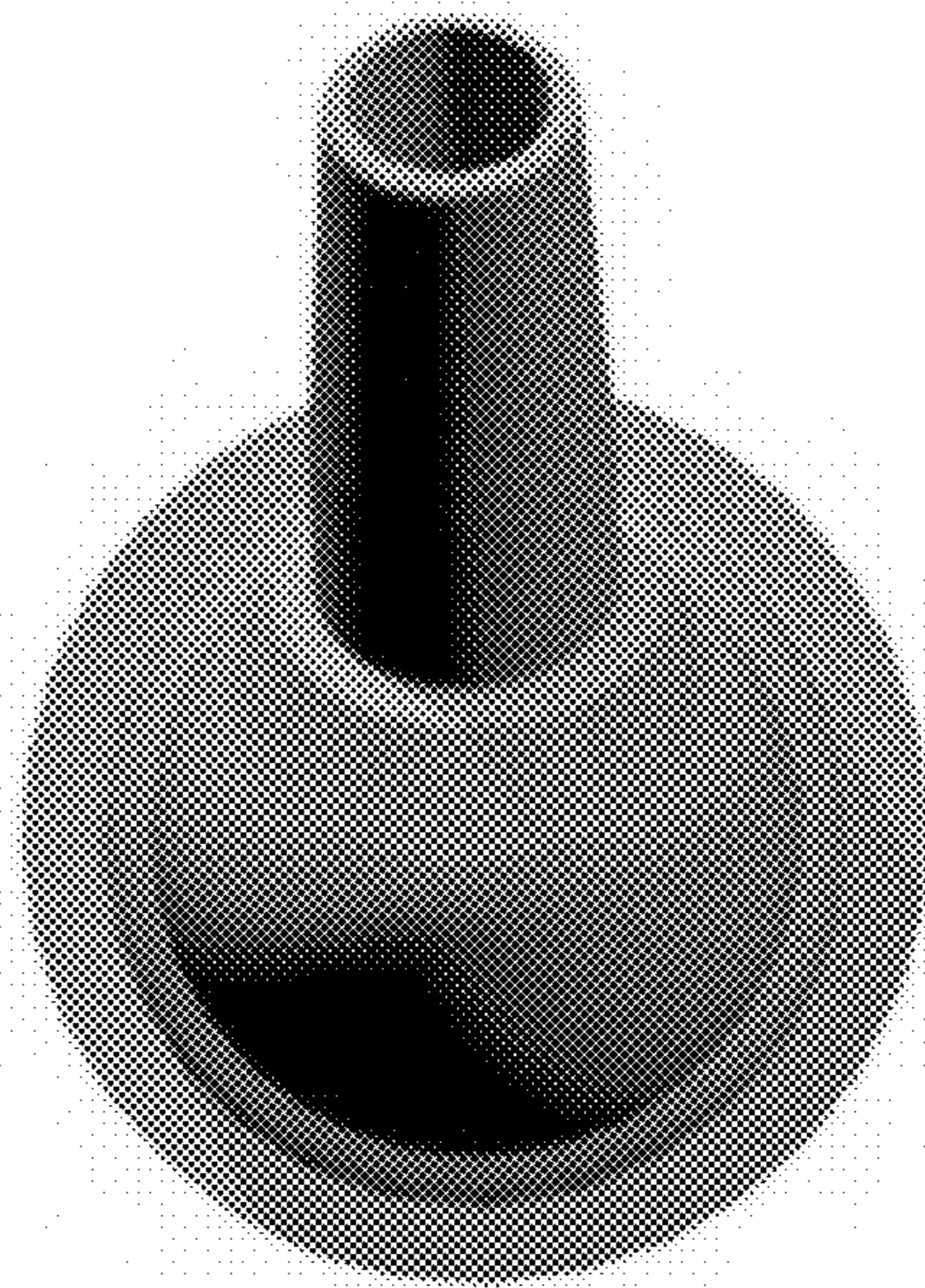

**4.5**

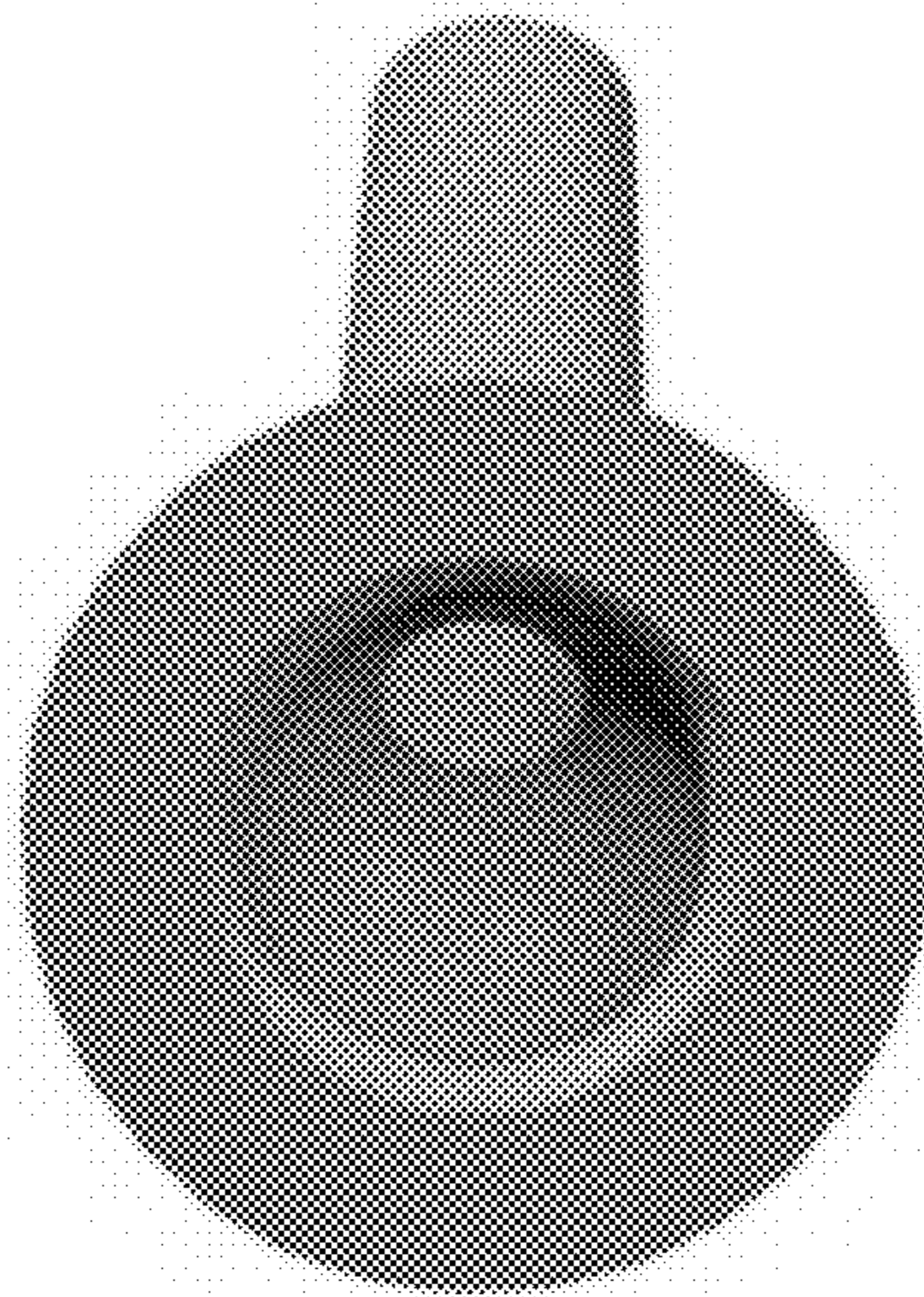

**4.6**

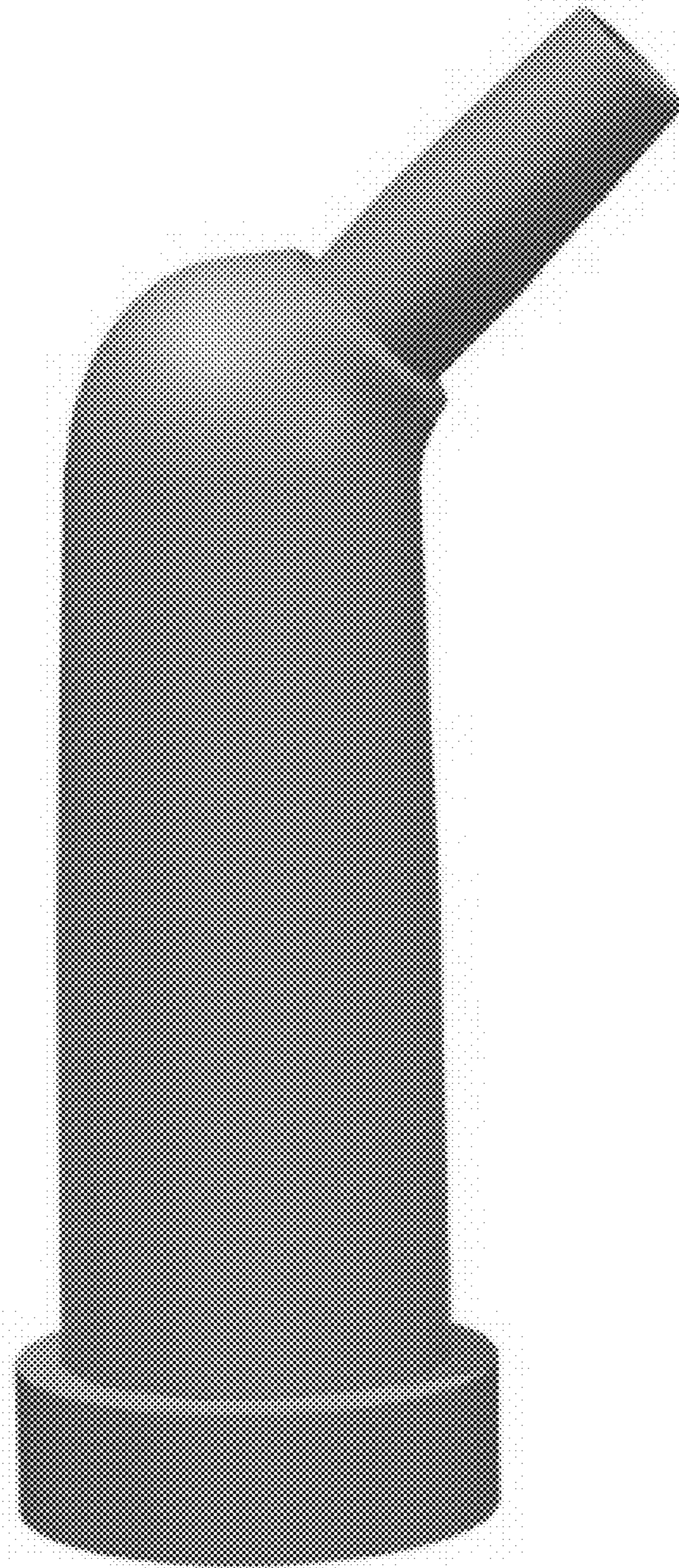

**4.7**

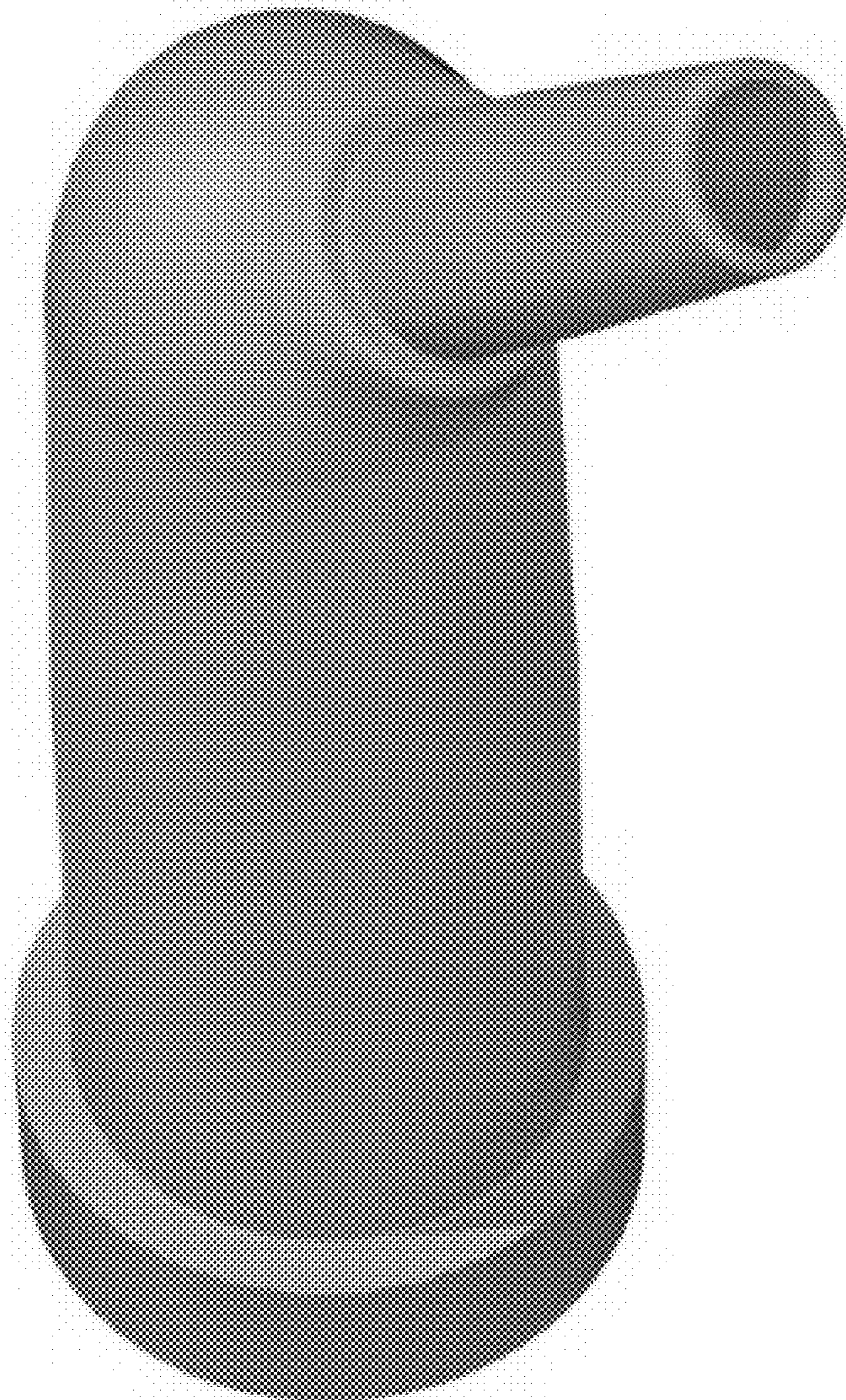

# 5.1

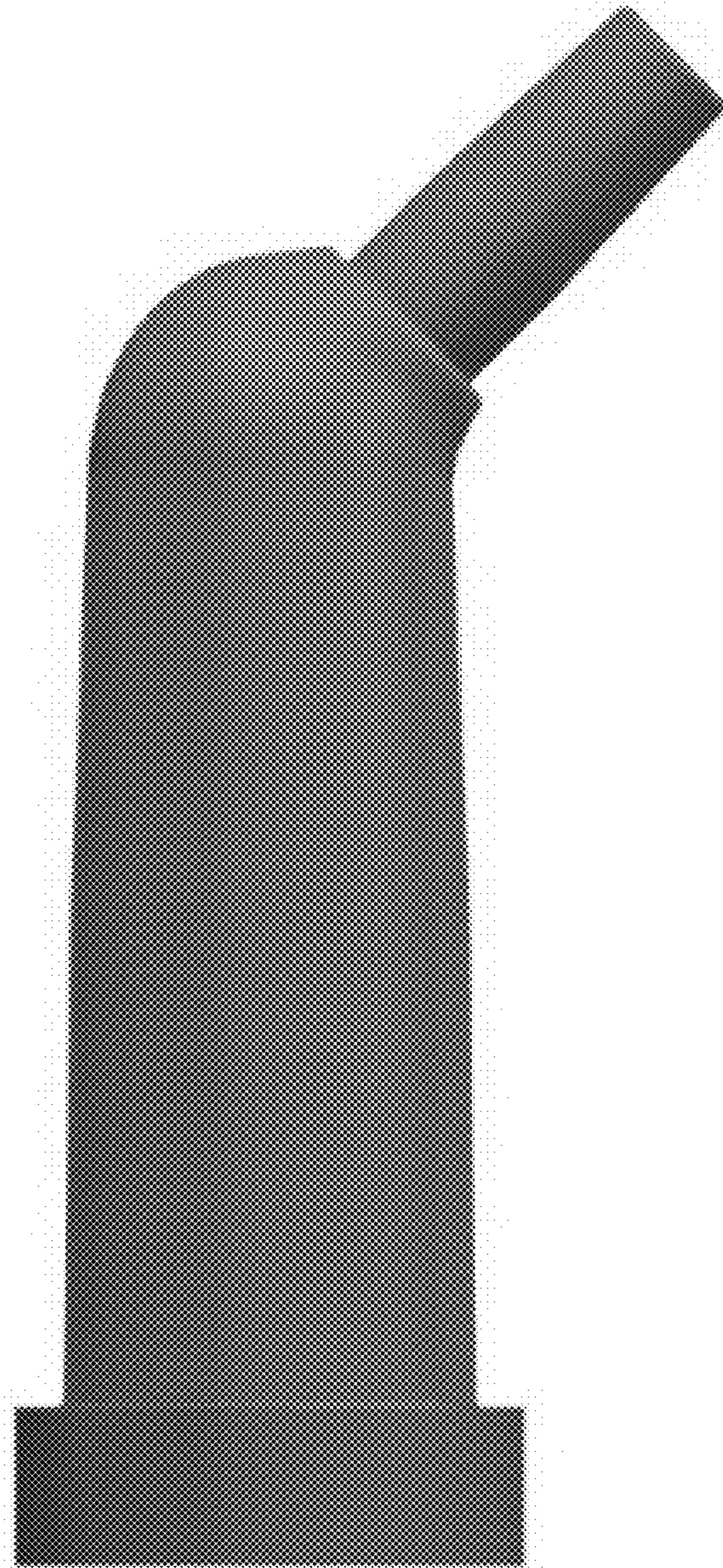

5.2

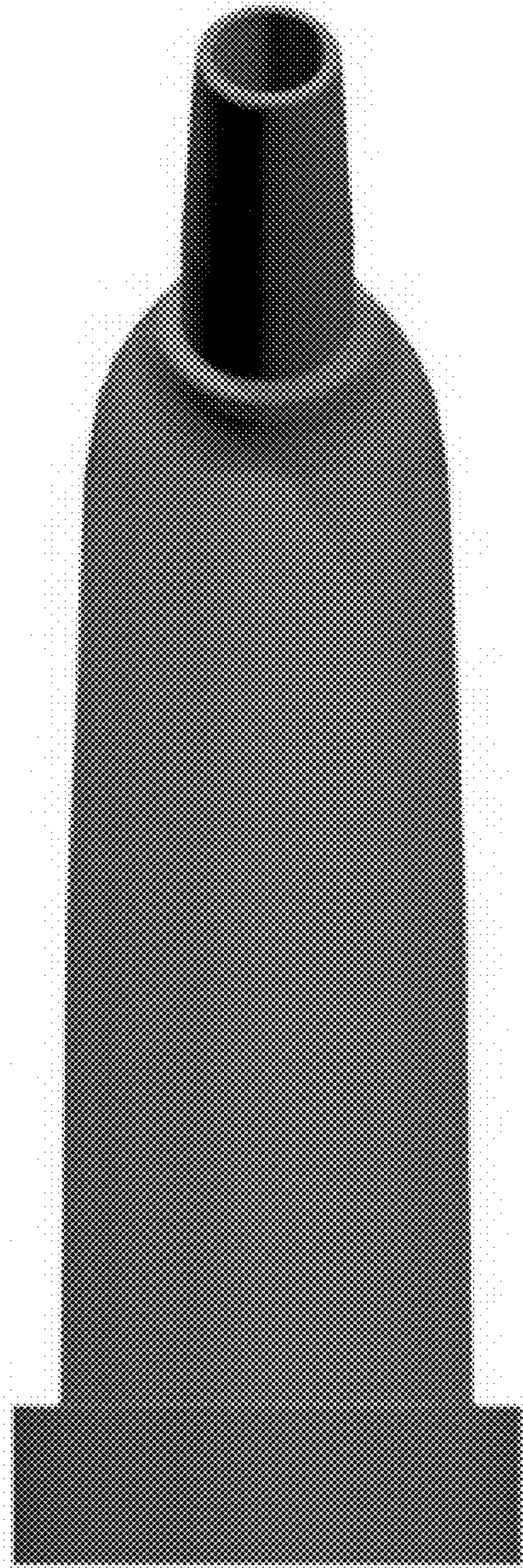



**5.3**

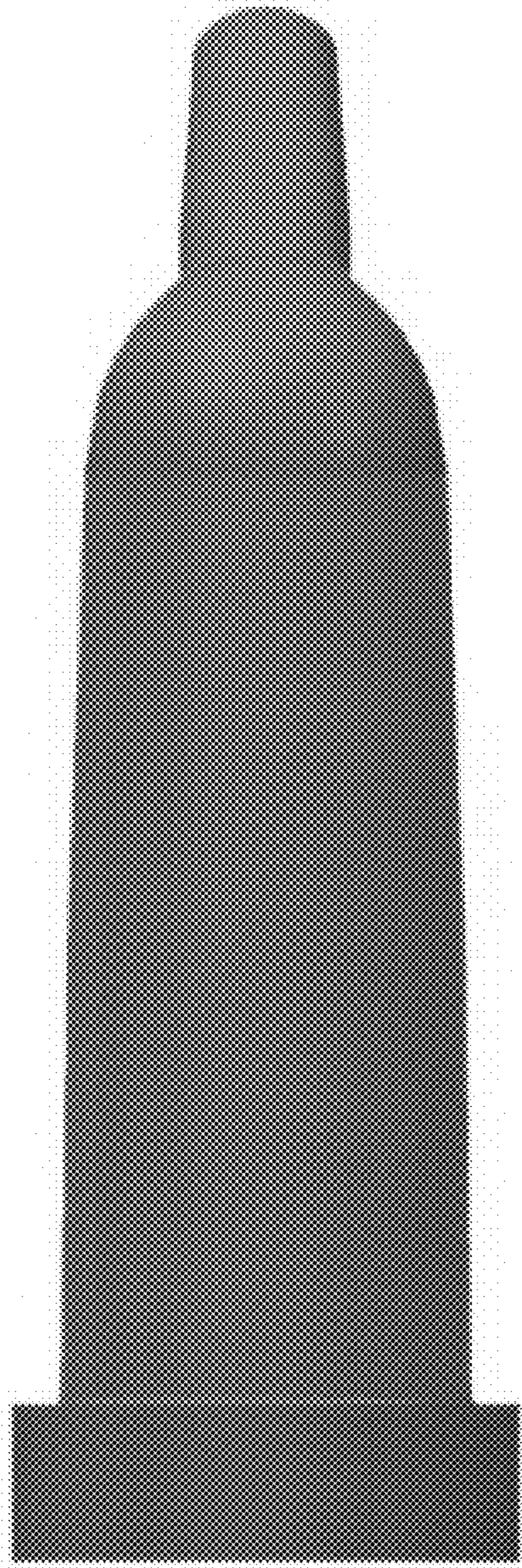

5.4

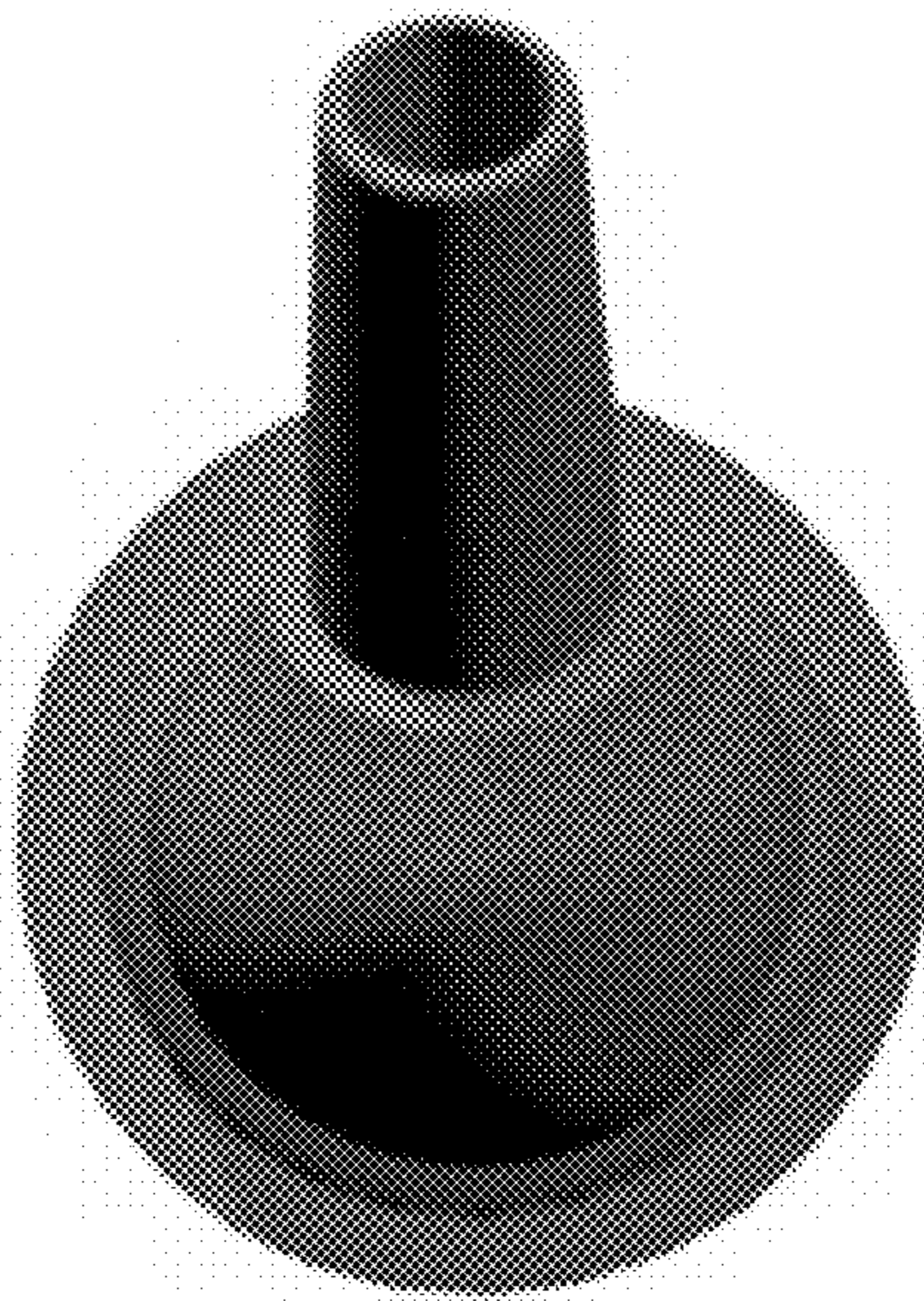

**5.5**

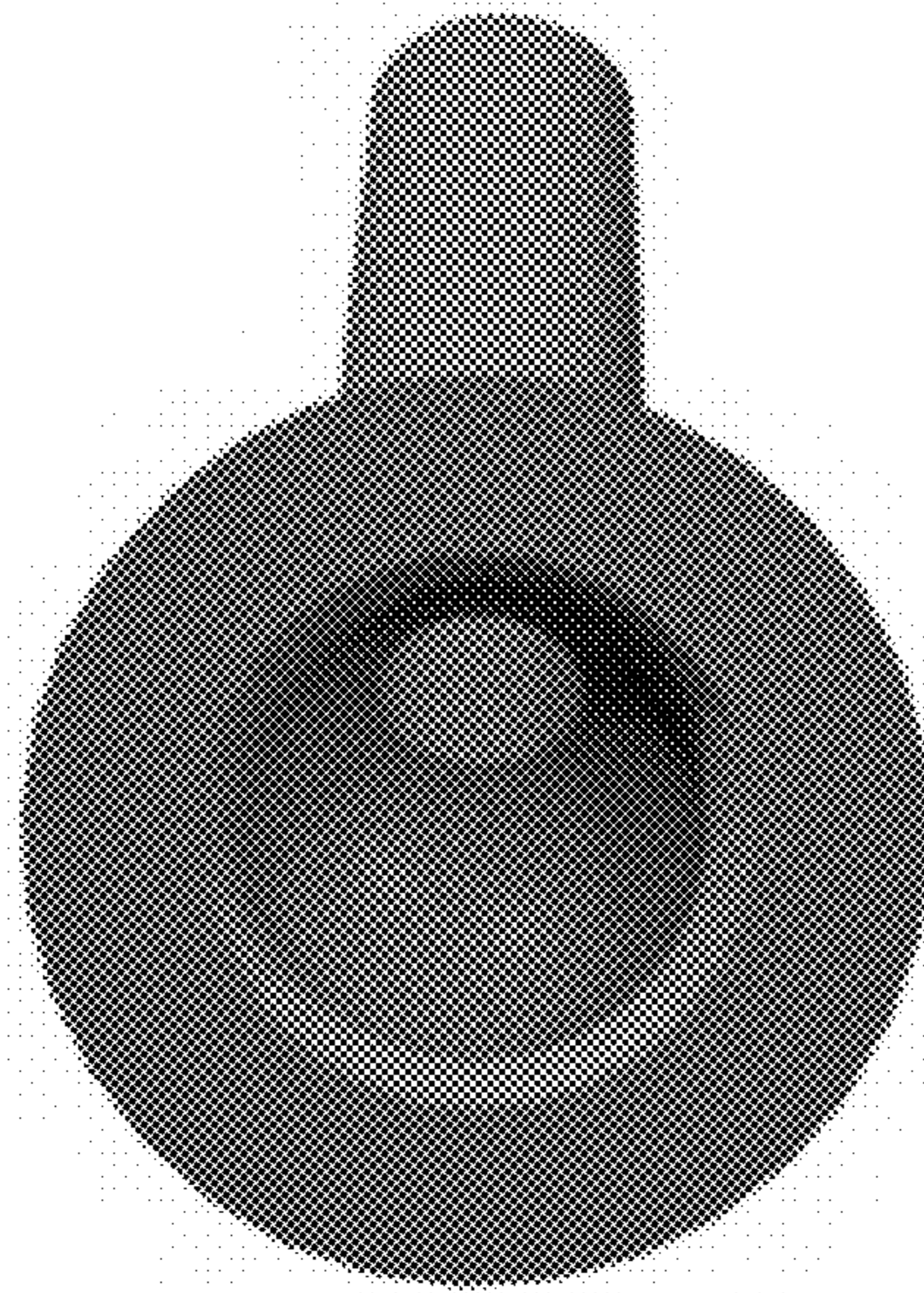

**5.6**



**5.7**

