



US00D800314S

(12) **United States Design Patent**
Kimura

(10) **Patent No.:** **US D800,314 S**
(45) **Date of Patent:** **** Oct. 17, 2017**

(54) **EYE TESTING APPARATUS AND EQUIPMENT**
(71) Applicant: **CREWT MEDICAL SYSTEMS, INC., Tokyo (JP)**
(72) Inventor: **Shinji Kimura, Tokyo (JP)**
(73) Assignee: **CREWT Medical Systems, Inc., Tokyo (JP)**
(**) Term: **15 Years**

5,838,424 A * 11/1998 Wawro A61B 3/02
351/200
D483,873 S * 12/2003 Schwartz D24/172
6,685,317 B2 * 2/2004 Su A61F 9/008
351/206
D552,736 S * 10/2007 Yamaoka D24/172
D582,556 S * 12/2008 Yamaoka D16/200
D589,622 S * 3/2009 Koest D10/46
D607,562 S * 1/2010 Heine D24/137
D614,774 S * 4/2010 Gausmann D24/160
D698,444 S * 1/2014 Mensink D24/172
D705,430 S * 5/2014 Sekine D24/172
D709,199 S * 7/2014 Kambe D24/172
D734,471 S * 7/2015 Pollanen D24/172
D738,509 S * 9/2015 van Elzakker D24/172

(21) Appl. No.: **35/501,003**

* cited by examiner

(22) Filed: **Nov. 26, 2015**

Primary Examiner — Darlington Ly

(80) **Hague Agreement Data**

(74) *Attorney, Agent, or Firm* — Bunkyo Patent Firm

Int. Filing Date: **Nov. 26, 2015**
Int. Reg. No.: **DM/088602**
Int. Reg. Date: **Nov. 26, 2015**
Int. Reg. Pub. Date: **May 27, 2016**

(57) **CLAIM**

The ornamental design for an eye testing apparatus and equipment, as shown and described.

(51) **LOC (10) Cl.** **24-00**

(52) **U.S. Cl.**
USPC **D24/172**

(58) **Field of Classification Search**
USPC D24/172, 137, 231
CPC A61B 3/18; A61B 3/032; A61B 19/0248
See application file for complete search history.

DESCRIPTION

1. Eye testing apparatus and equipment
1.1 is a top, front, and left side perspective view of an eye testing apparatus and equipment showing my new design;
1.2 is a top, rear, and left side perspective view thereof;
1.3 is a front elevational view thereof;
1.4 is a rear elevational view thereof;
1.5 is a left side elevational view thereof;
1.6 is a top plan view thereof; and
1.7 is a bottom plan view thereof.

(56) **References Cited**

U.S. PATENT DOCUMENTS

5,459,536 A * 10/1995 Shalon A61B 3/0083
351/222
D393,066 S * 3/1998 Laun D24/137

The broken lines in the reproductions illustrate portions of the eye testing apparatus and equipment that form no part of the claimed design.

1 Claim, 7 Drawing Sheets

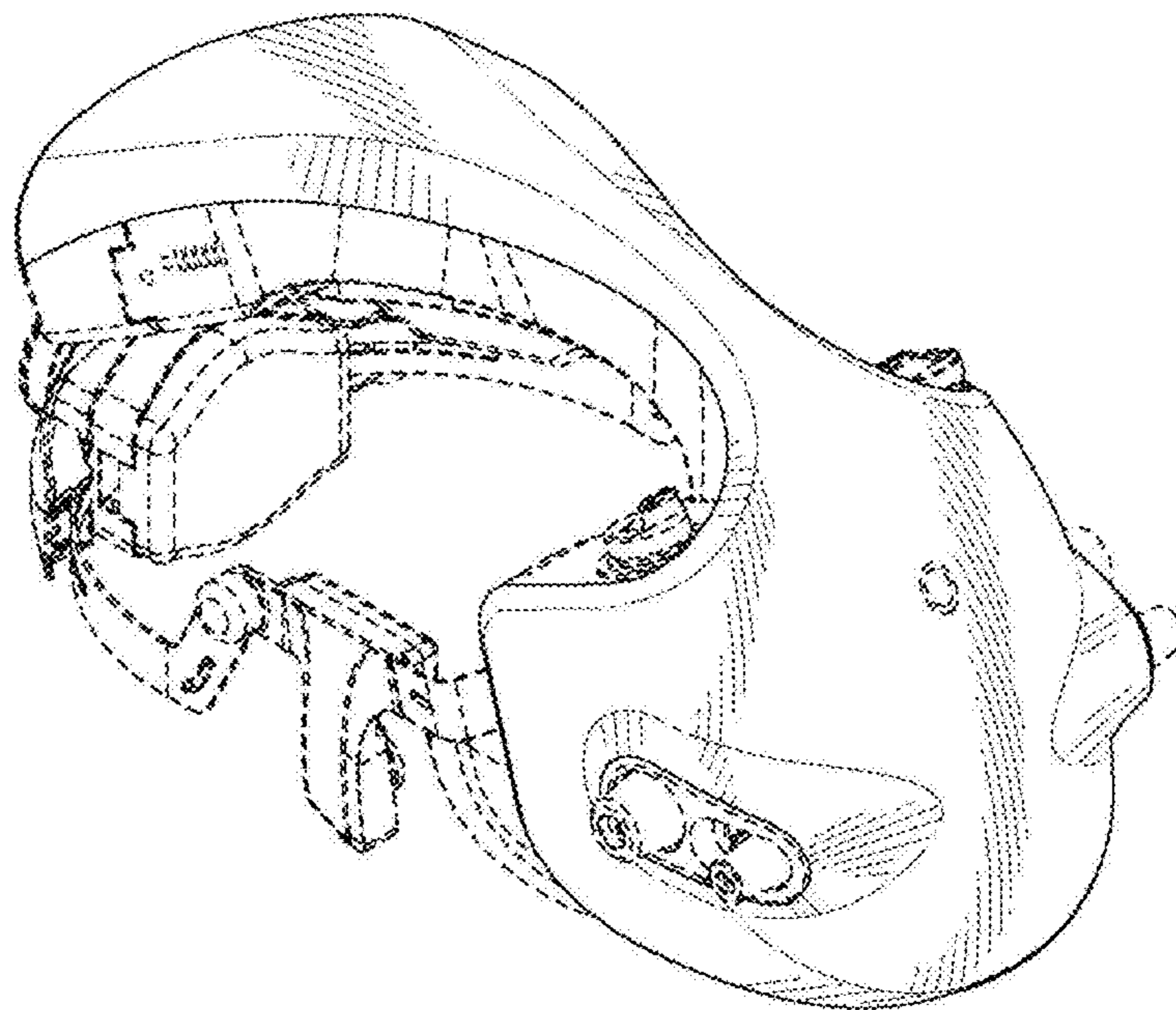

1.1

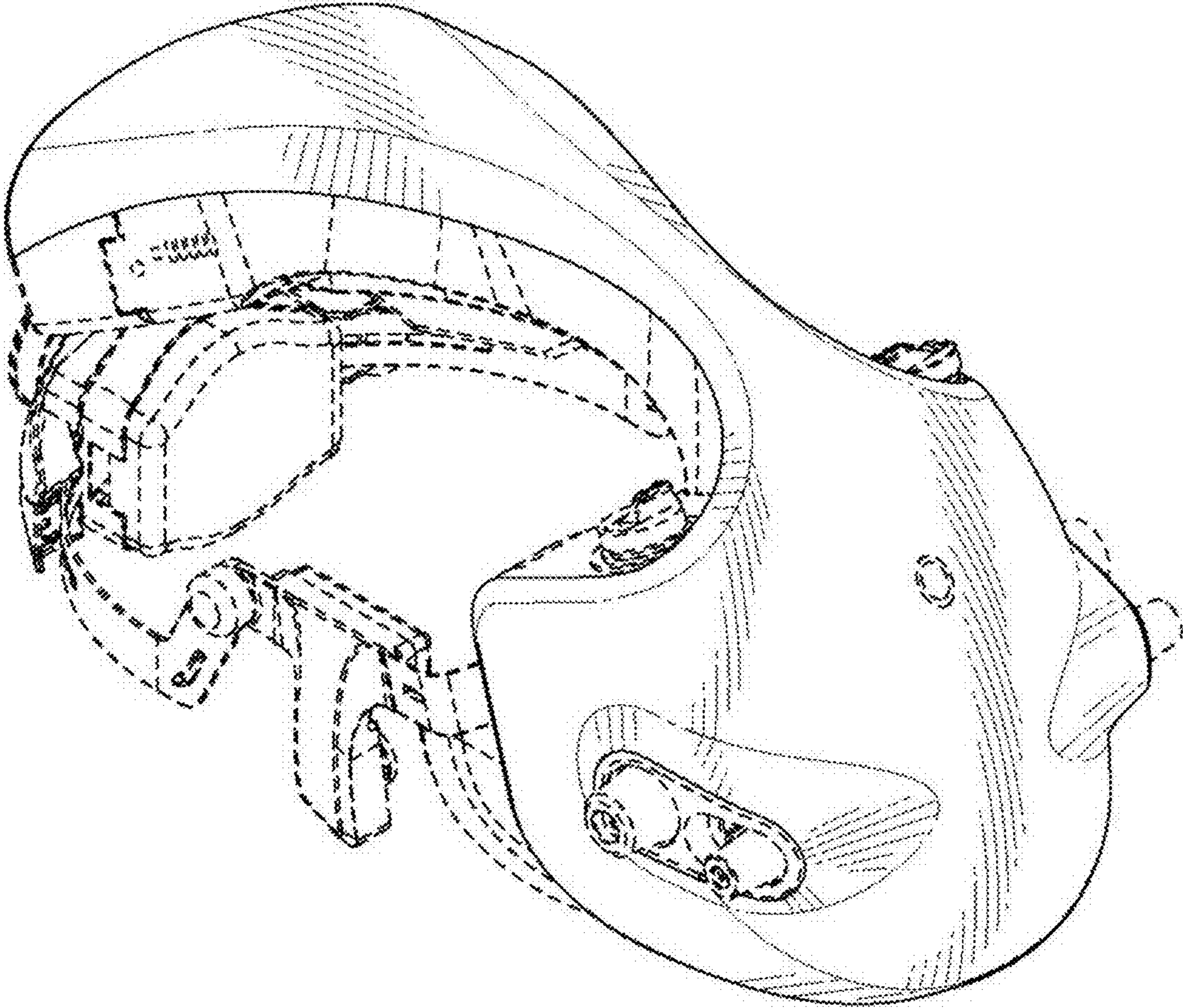

1.2

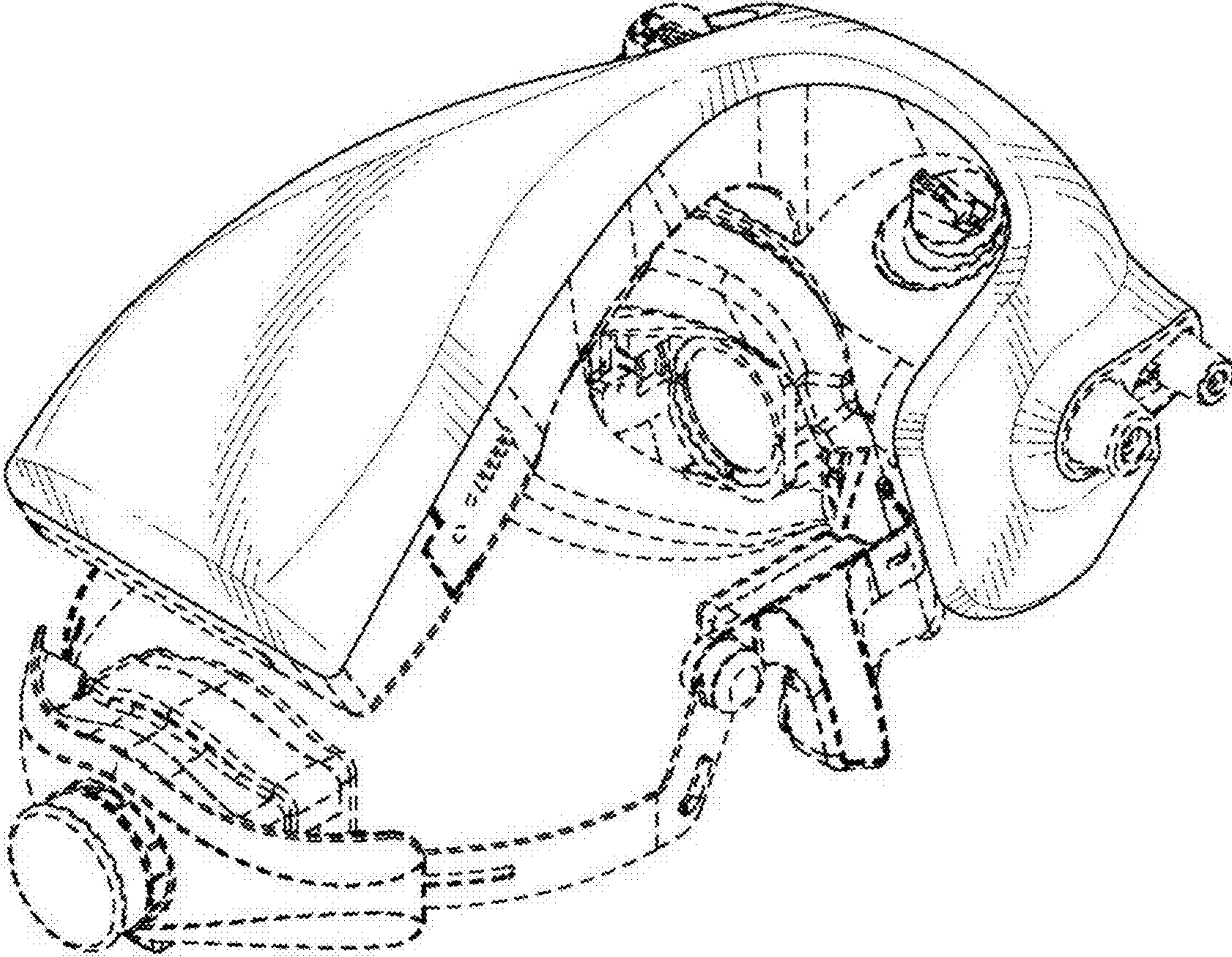

1.3

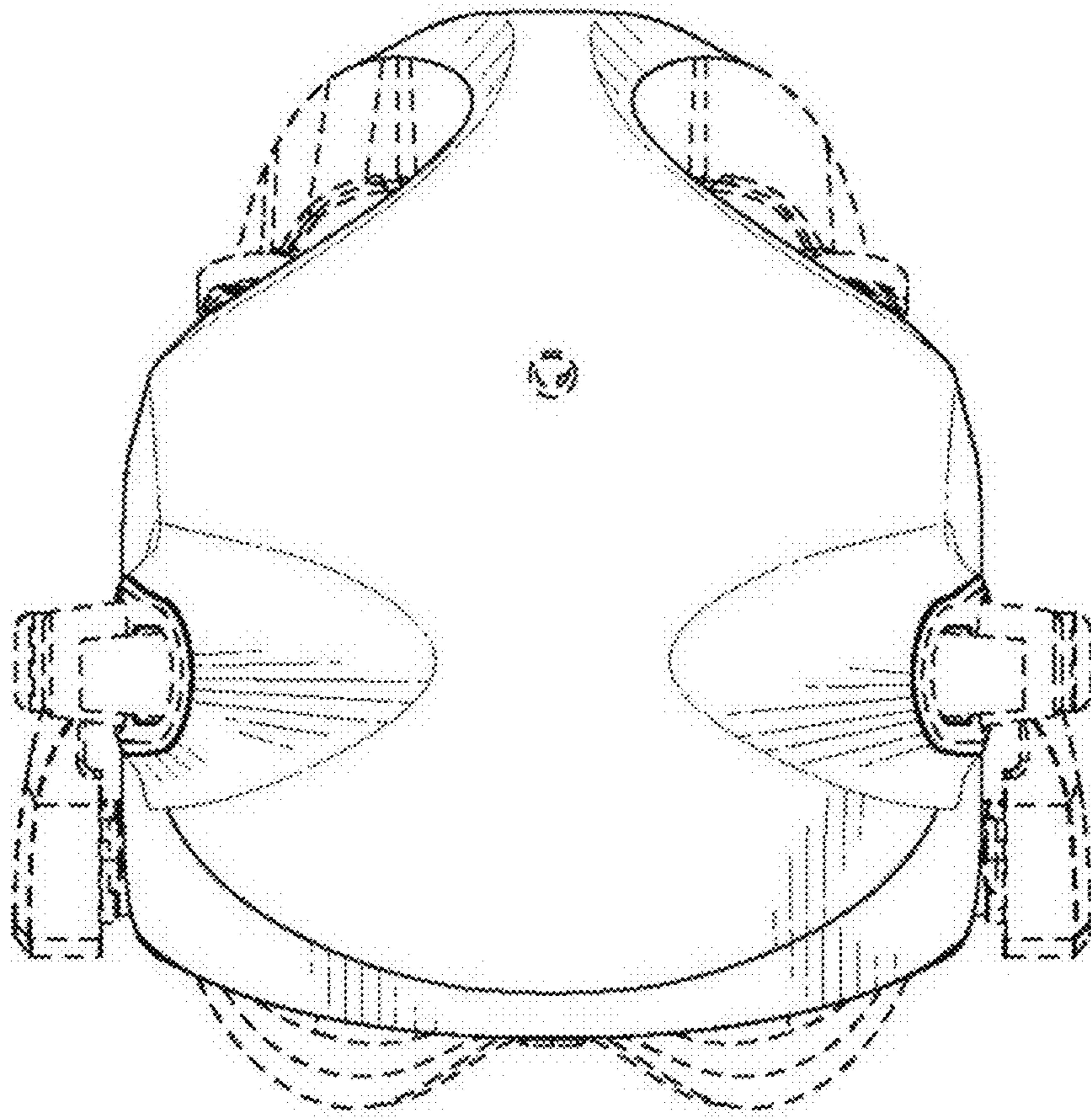

1.4

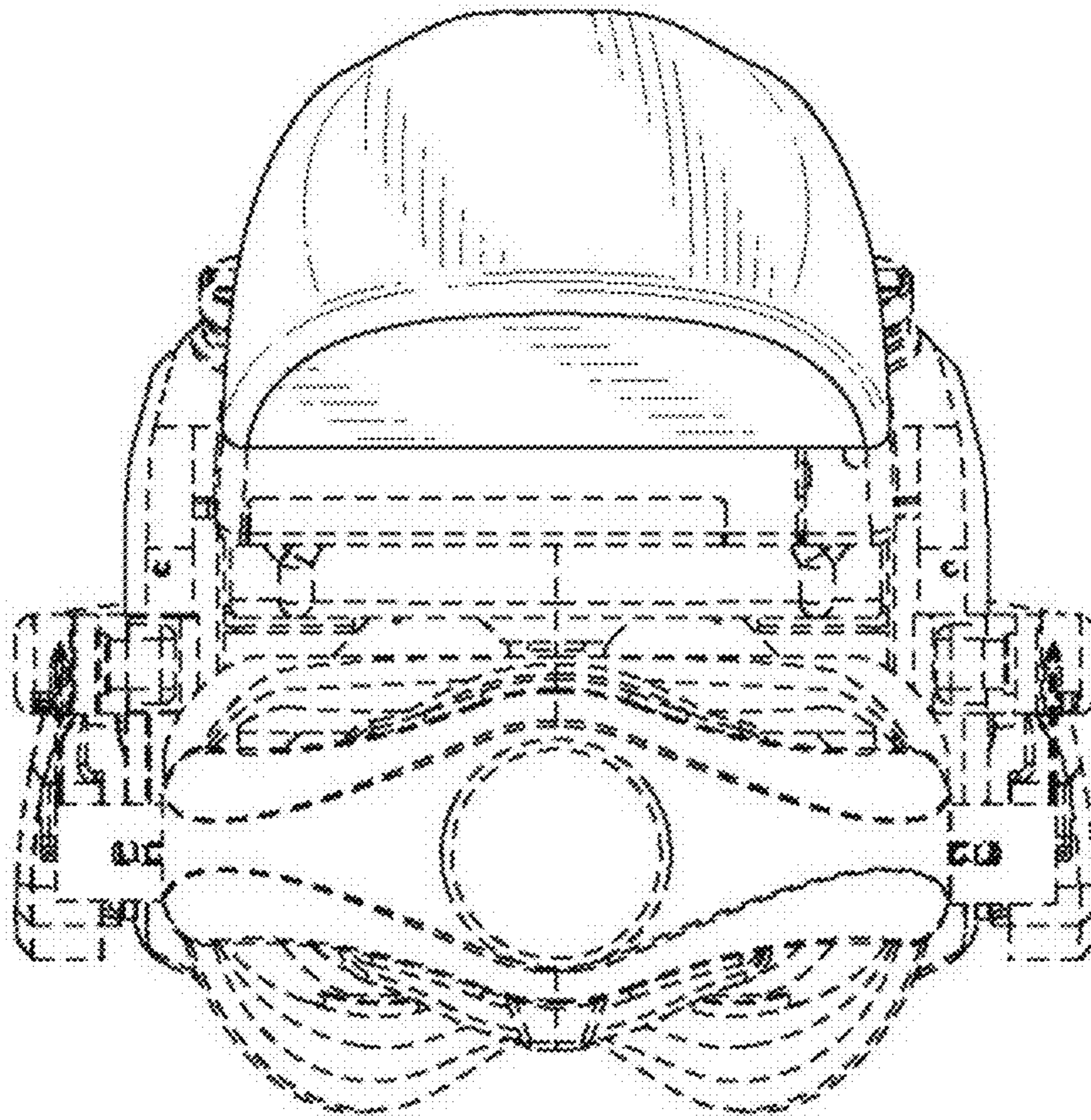

1.5

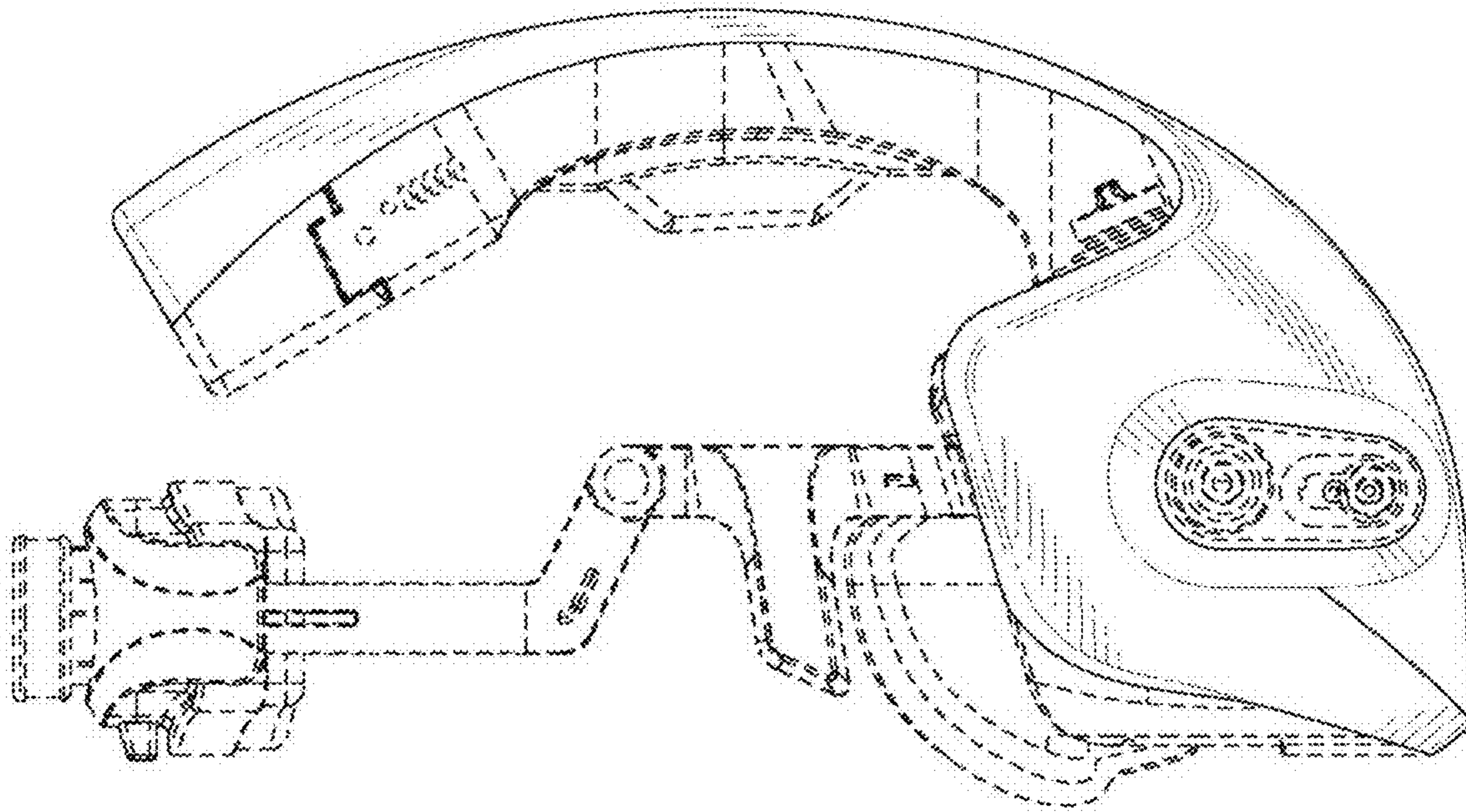

1.6

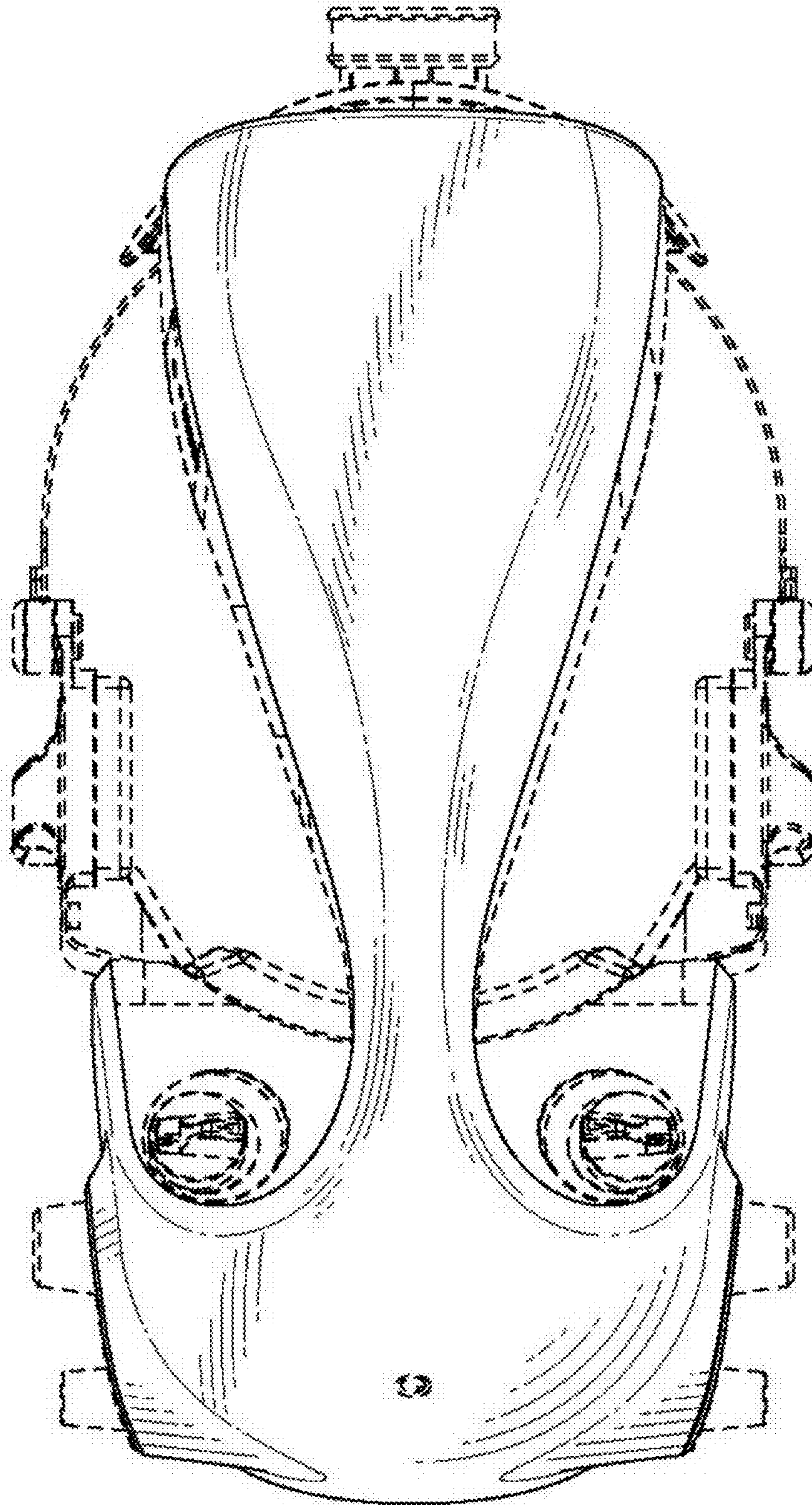

1.7

