



US00D800299S

(12) **United States Design Patent** (10) **Patent No.:** **US D800,299 S**
Gunaratnam et al. (45) **Date of Patent:** **** Oct. 17, 2017**

(54) **MASK**

FOREIGN PATENT DOCUMENTS

(75) Inventors: **Michael K. Gunaratnam**, Marsfield (AU); **Philip R. Kwok**, Chatswood (AU); **Robin G. Hitchcock**, Normanhurst (AU); **Lee J. Veliss**, Freshwater (AU); **Memduh Guney**, Killara (AU); **Richard Sokolov**, Earlwood (AU); **Perry D. Lithgow**, Moruya (AU); **Donald Darkin**, La Jolla, CA (US); **Susan R. Lynch**, Bella Vista (AU); **Rachael E. Moore**, North Bondi (AU)

JP 2009039528 A * 2/2009
WO WO 2009059353 A1 * 5/2009 A61M 16/06
(Continued)

(73) Assignee: **RESMED LIMITED**, Bella Vista (AU)

OTHER PUBLICATIONS

Gunaratnam et al., Parent U.S. Appl. No. 29/311,731, filed Jun. 8, 2009.

(**) Term: **14 Years**

(21) Appl. No.: **29/413,304**

(22) Filed: **Feb. 14, 2012**

Related U.S. Application Data

(60) Continuation of application No. 29/311,731, filed on Jun. 8, 2009, now Pat. No. Des. 656,607, which is a continuation of application No. 29/265,319, filed on Aug. 30, 2006, now Pat. No. Des. 608,882, which is (Continued)

(Continued)

Primary Examiner — Richelle G Shelton

(74) *Attorney, Agent, or Firm* — Nixon & Vanderhye, P.C.

(51) **LOC (10) Cl.** **29-02**

(52) **U.S. Cl.**
USPC **D24/110.4; D24/110.5**

(58) **Field of Classification Search**
USPC D24/110, 110.1–110.5, 191; 128/206.11, 128/206.12, 207.13, 207.18; 602/17; 604/94.01
CPC A61M 16/0666; A61M 16/0683; A61M 16/0677; A61M 16/0672
See application file for complete search history.

(57) **CLAIM**

The ornamental design for a mask, as shown and described.

DESCRIPTION

FIG. 1 is a front view of a mask according to our new ornamental design;
FIG. 2 is a rear view thereof;
FIG. 3 is a top view thereof;
FIG. 4 is a bottom view thereof;
FIG. 5 is a left side view thereof;
FIG. 6 is a right side view thereof; and,
FIG. 7 is an exploded front perspective view thereof in a condition in which the positions of the swivel elbow and plug have been interchanged.
The broken lines show structure that forms no part of the claimed design. The dotted lines show the boundary between claimed and unclaimed subject matter and form no part of the claimed design.
The illustration of stitching in the figures forms part of the claimed design.

(56) **References Cited**

U.S. PATENT DOCUMENTS

2,763,263 A 9/1956 Ellman
3,086,529 A 4/1963 Munz et al.
3,513,844 A 5/1970 Smith

(Continued)

1 Claim, 7 Drawing Sheets

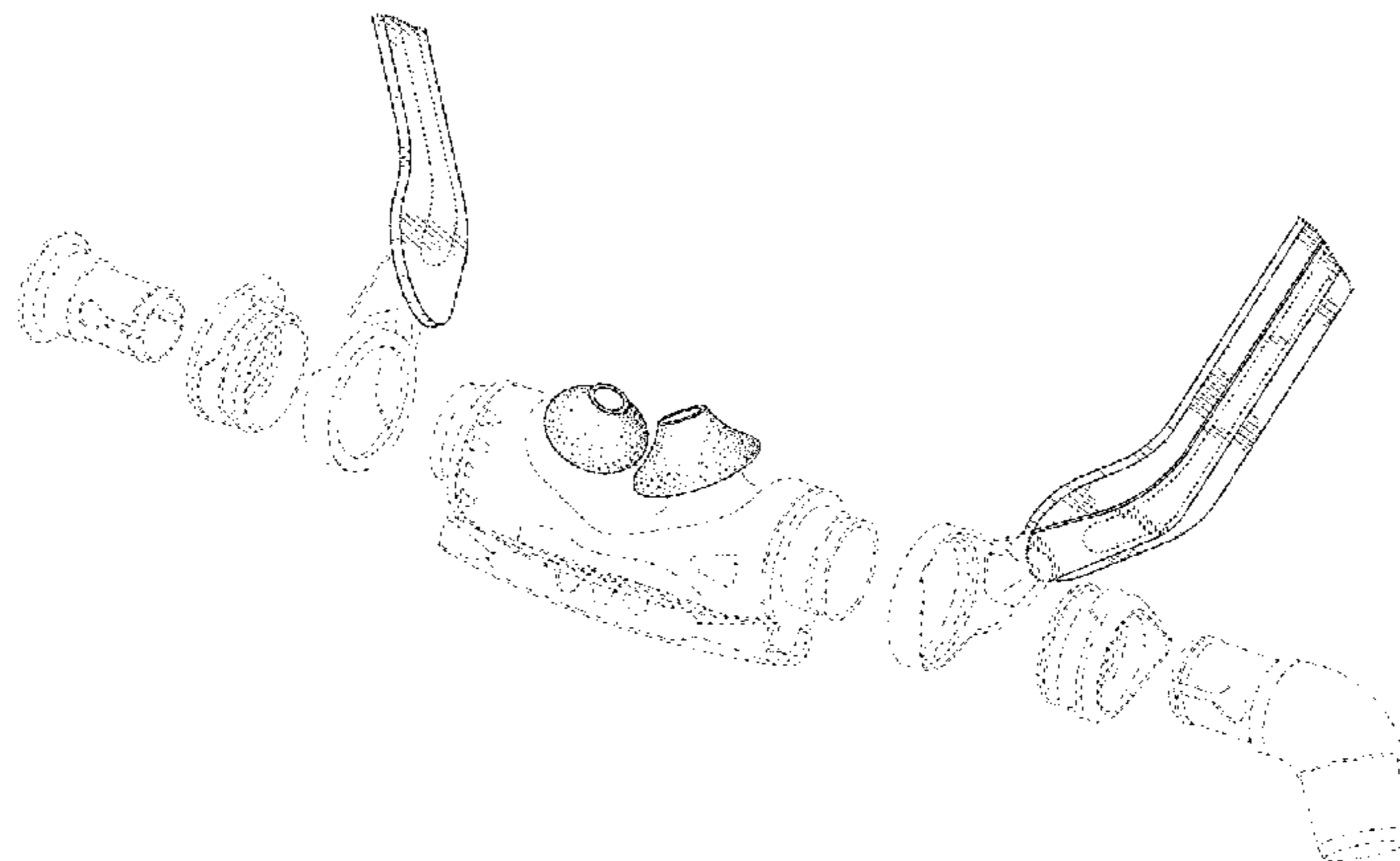

Related U.S. Application Data

a division of application No. 29/213,882, filed on
May 28, 2004, now Pat. No. Des. 542,912.

(56)

References Cited

U.S. PATENT DOCUMENTS

D237,220	S	10/1975	Stackhouse	
4,782,832	A	11/1988	Trimble et al.	
D383,204	S	9/1997	Lomas	
6,119,694	A	9/2000	Correa et al.	
6,318,363	B1	11/2001	Monnich	
6,431,172	B1	8/2002	Bordewick	
6,595,215	B2	7/2003	Wood	
6,889,689	B1	5/2005	Neuman	
6,907,882	B2	6/2005	Ging et al.	
D542,912	S *	5/2007	Gunaratnam et al.	D24/110.5
D545,961	S *	7/2007	Hitchcock et al.	D24/110.1
D546,441	S *	7/2007	Hitchcock et al.	D24/110.1
D549,323	S	8/2007	Kwok et al.	
D552,731	S *	10/2007	Moore et al.	D24/110.1
D556,899	S	12/2007	Veliss et al.	
D556,900	S	12/2007	Guney et al.	
D557,409	S	12/2007	Veliss et al.	
D557,410	S	12/2007	Guney et al.	
D557,800	S	12/2007	Hitchcock et al.	
7,318,437	B2	1/2008	Gunaratnam et al.	
D561,893	S	2/2008	Gunaratnam et al.	
D562,729	S	2/2008	Hitchcock et al.	
D562,976	S	2/2008	Guney et al.	
D588,690	S *	3/2009	Ging et al.	D24/110.1
D589,139	S	3/2009	Guney et al.	
D589,140	S	3/2009	Guney et al.	

D591,419	S *	4/2009	Chandran et al.	D24/110.1
D608,882	S	1/2010	Hitchcock et al.	
7,874,293	B2	1/2011	Gunaratnam et al.	
7,942,150	B2	5/2011	Guney et al.	
D650,064	S	12/2011	Gunaratnam et al.	
D651,303	S	12/2011	Gunaratnam et al.	
2001/0049505	A1	12/2001	Byrd	
2006/0137690	A1	6/2006	Gunaratnam et al.	
2009/0044808	A1 *	2/2009	Guney	A61M 16/0666 128/206.24
2009/0107508	A1 *	4/2009	Brambilla	A61M 16/06 128/207.11
2009/0126739	A1	5/2009	Ng et al.	
2010/0132716	A1	6/2010	Selvarajan et al.	
2010/0229868	A1	9/2010	Rummery et al.	
2011/0155140	A1	6/2011	Ho et al.	
2011/0232649	A1 *	9/2011	Collazo	A61M 16/06 128/207.18

FOREIGN PATENT DOCUMENTS

WO	WO 2009108994	A1 *	9/2009	A61M 16/06
WO	WO 2010139014	A1 *	12/2010	A61M 16/06

OTHER PUBLICATIONS

InnoMed Technologies, "Nasal-Pap Freestyle™" Brochure, 2004, 2 pages.
InnoMed Technologies, "Nasal Aire™" Brochure 2003, 1 page.
VIASYS Healthcare, "Lyra Nasal CPAP Interface" Brochure, 2004, 2 pages.

* cited by examiner

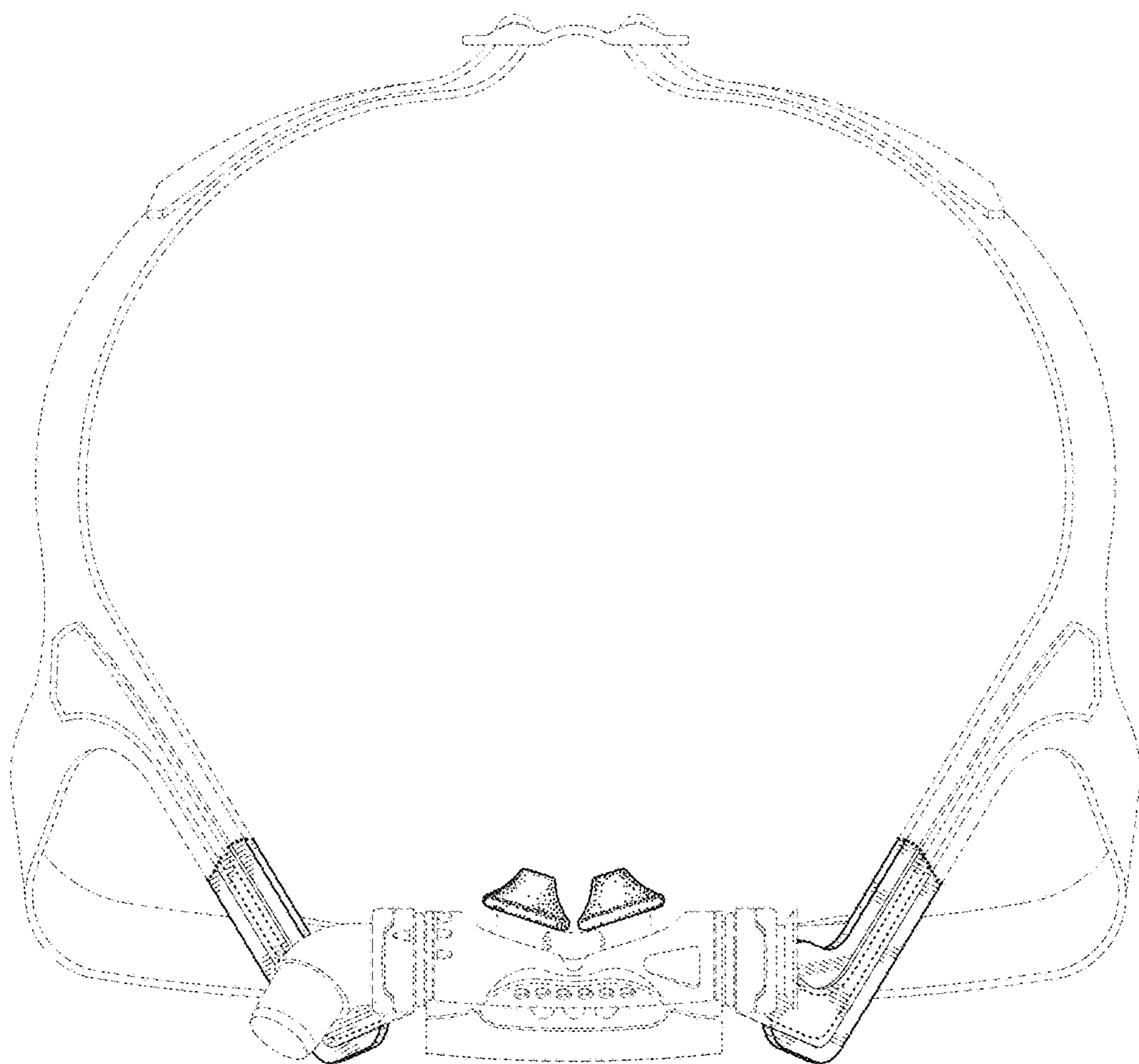

Fig. 1

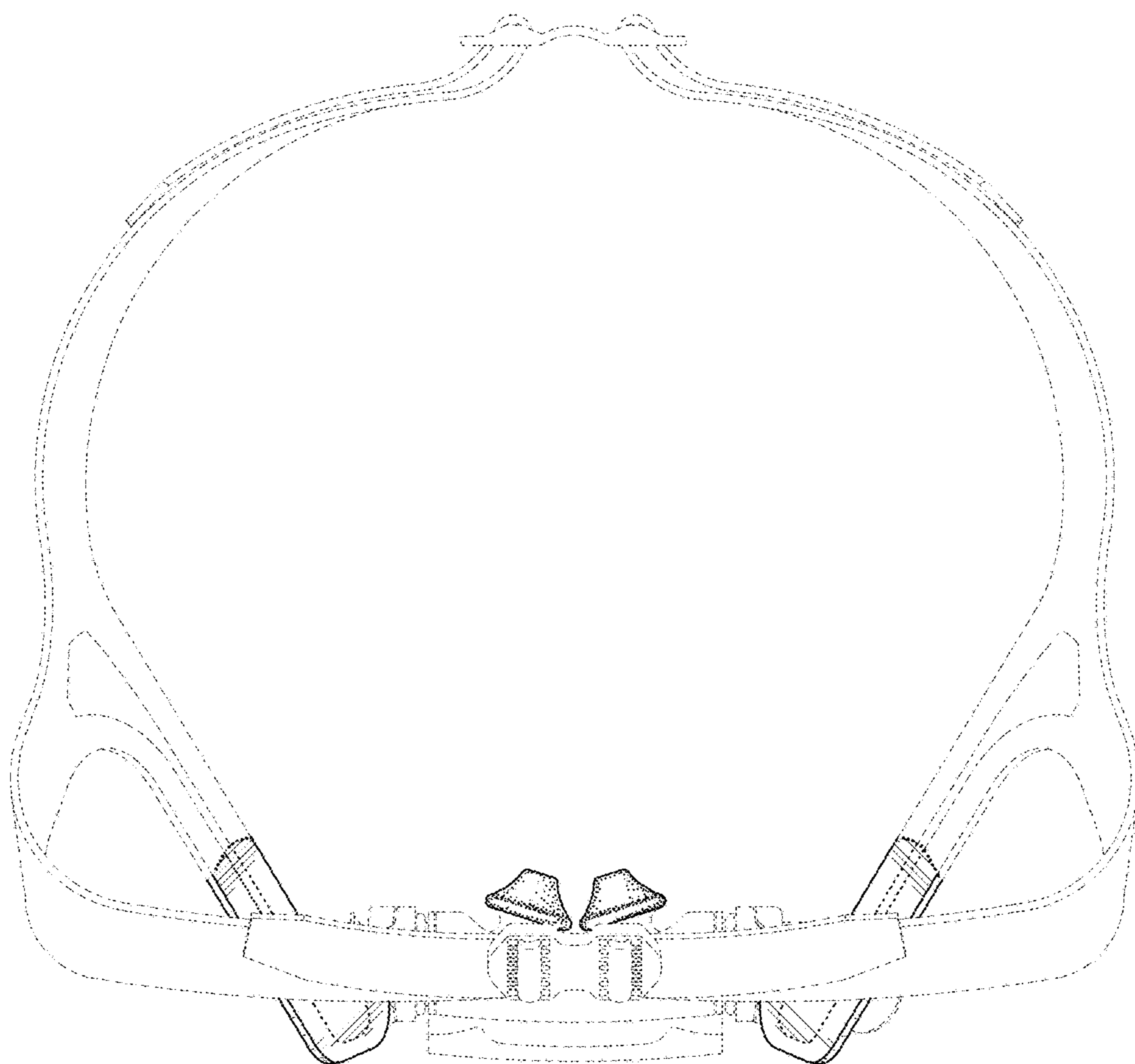

Fig. 2

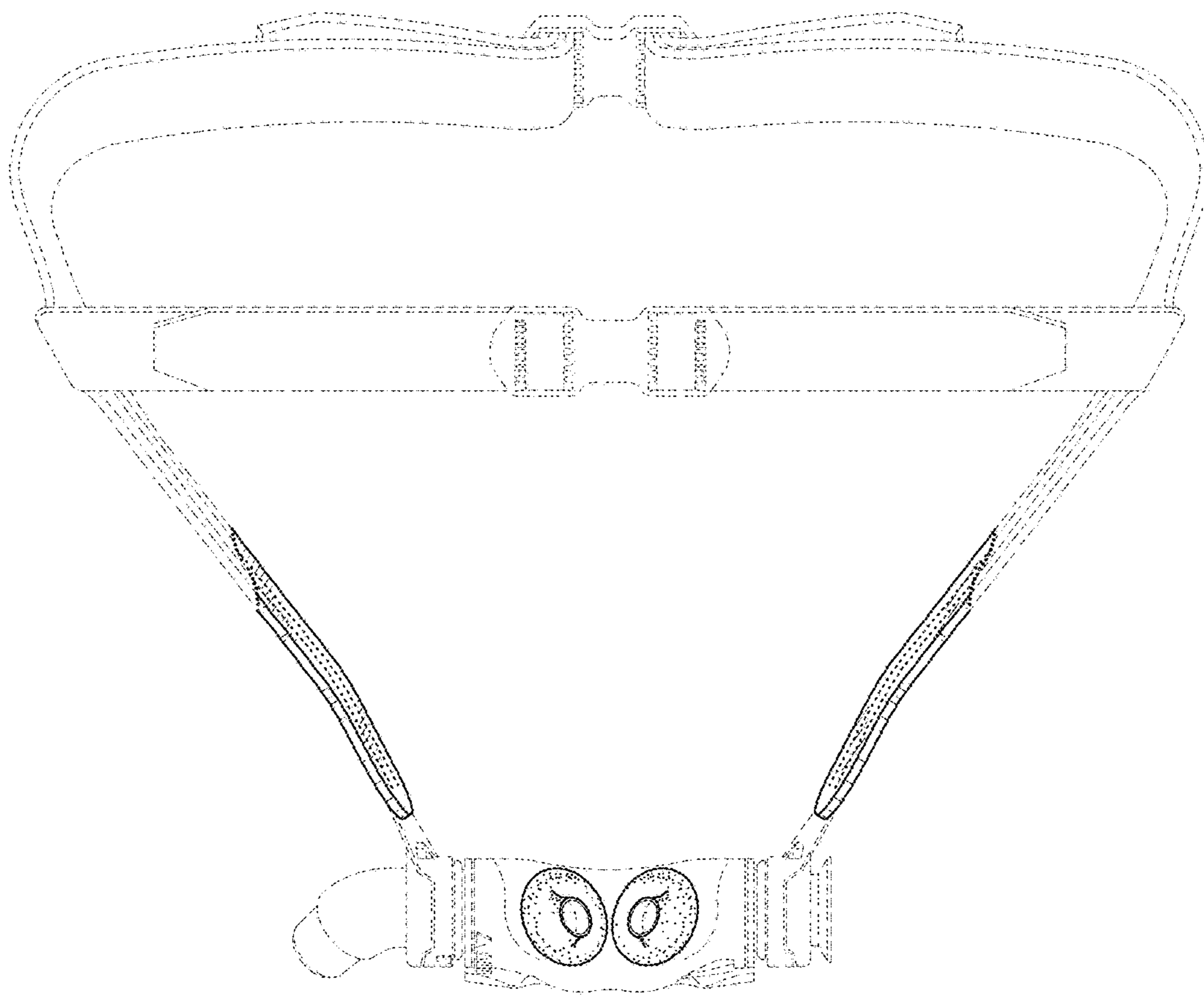

Fig. 3

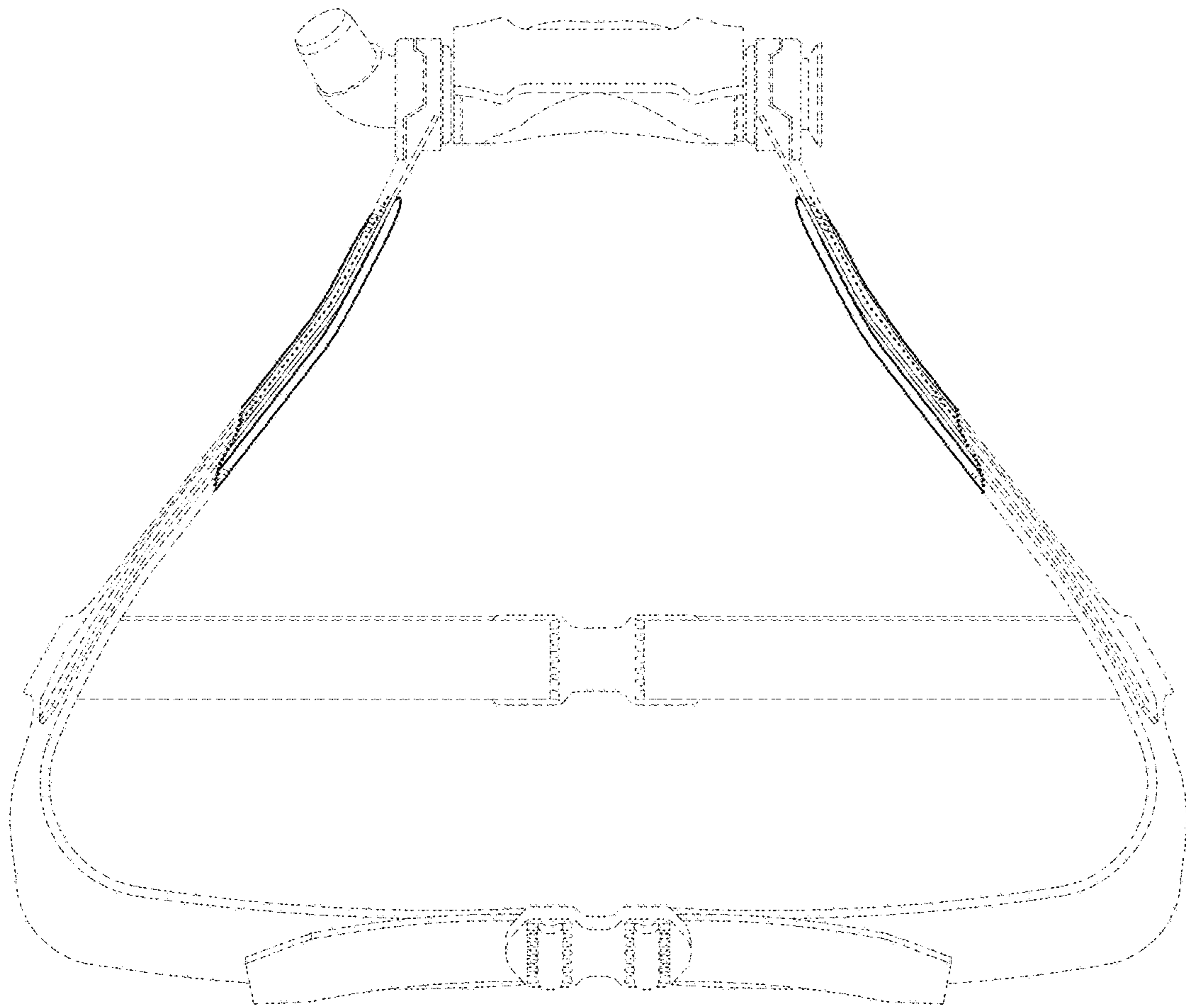

Fig. 4

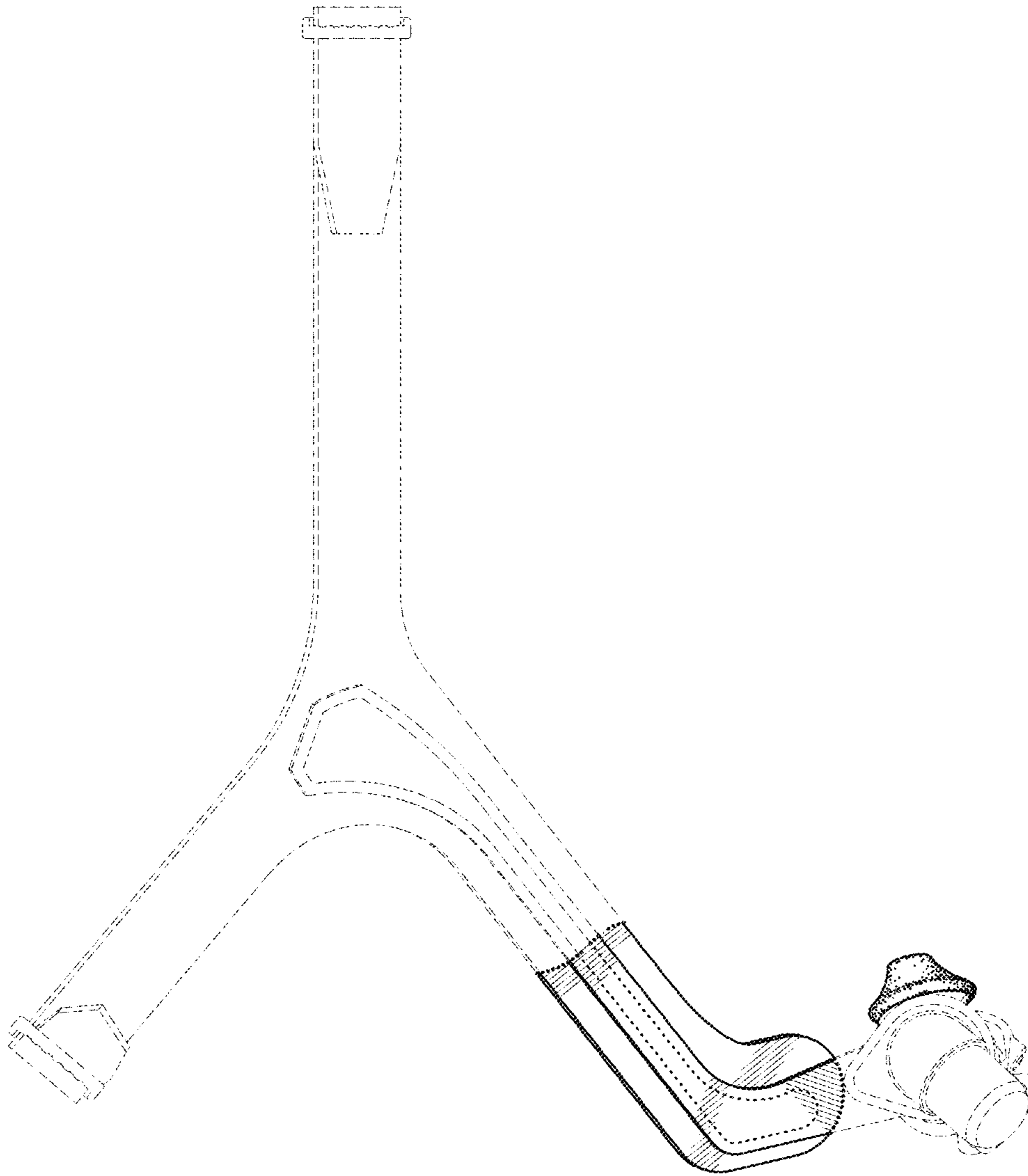

Fig. 5

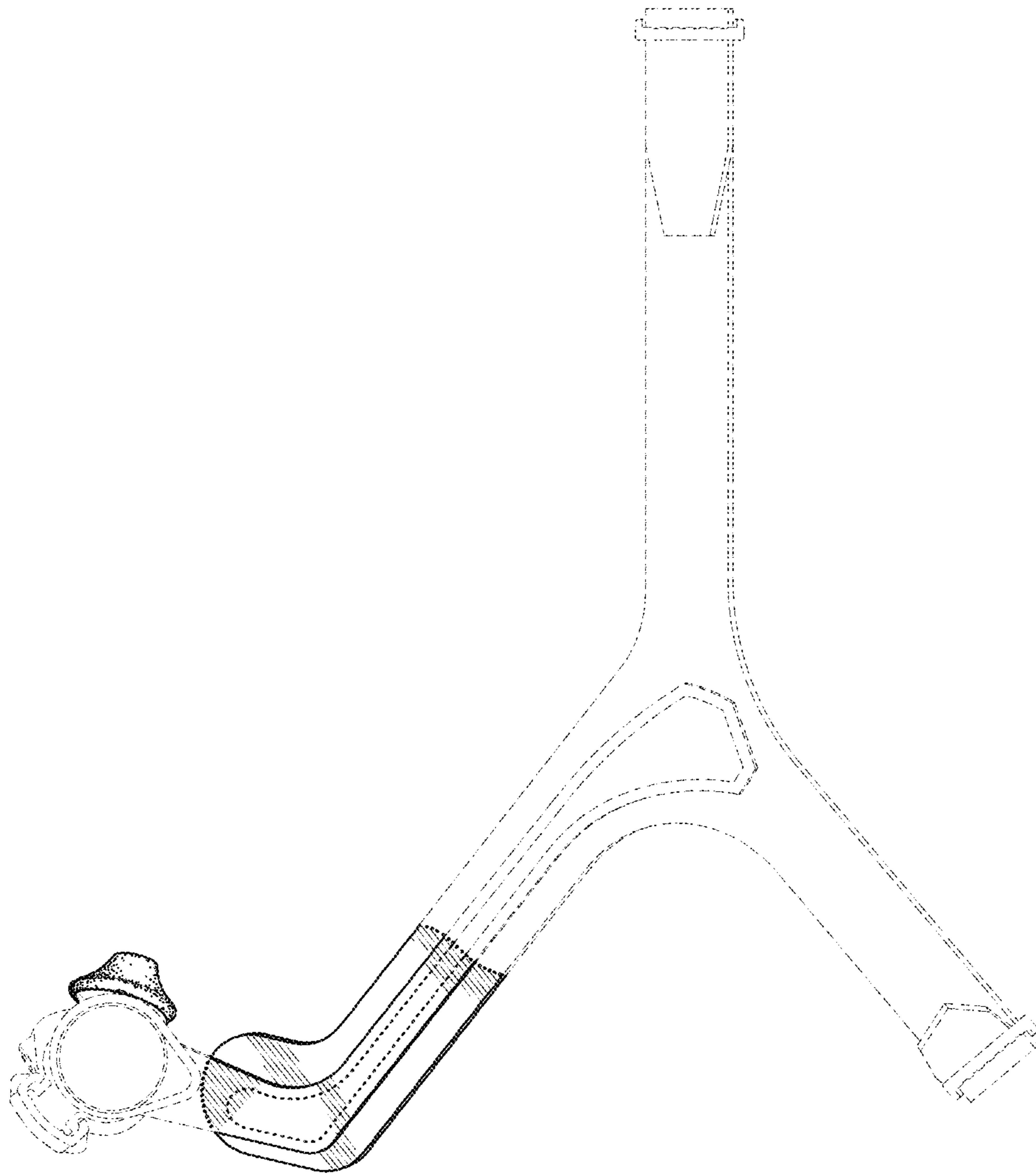

Fig. 6

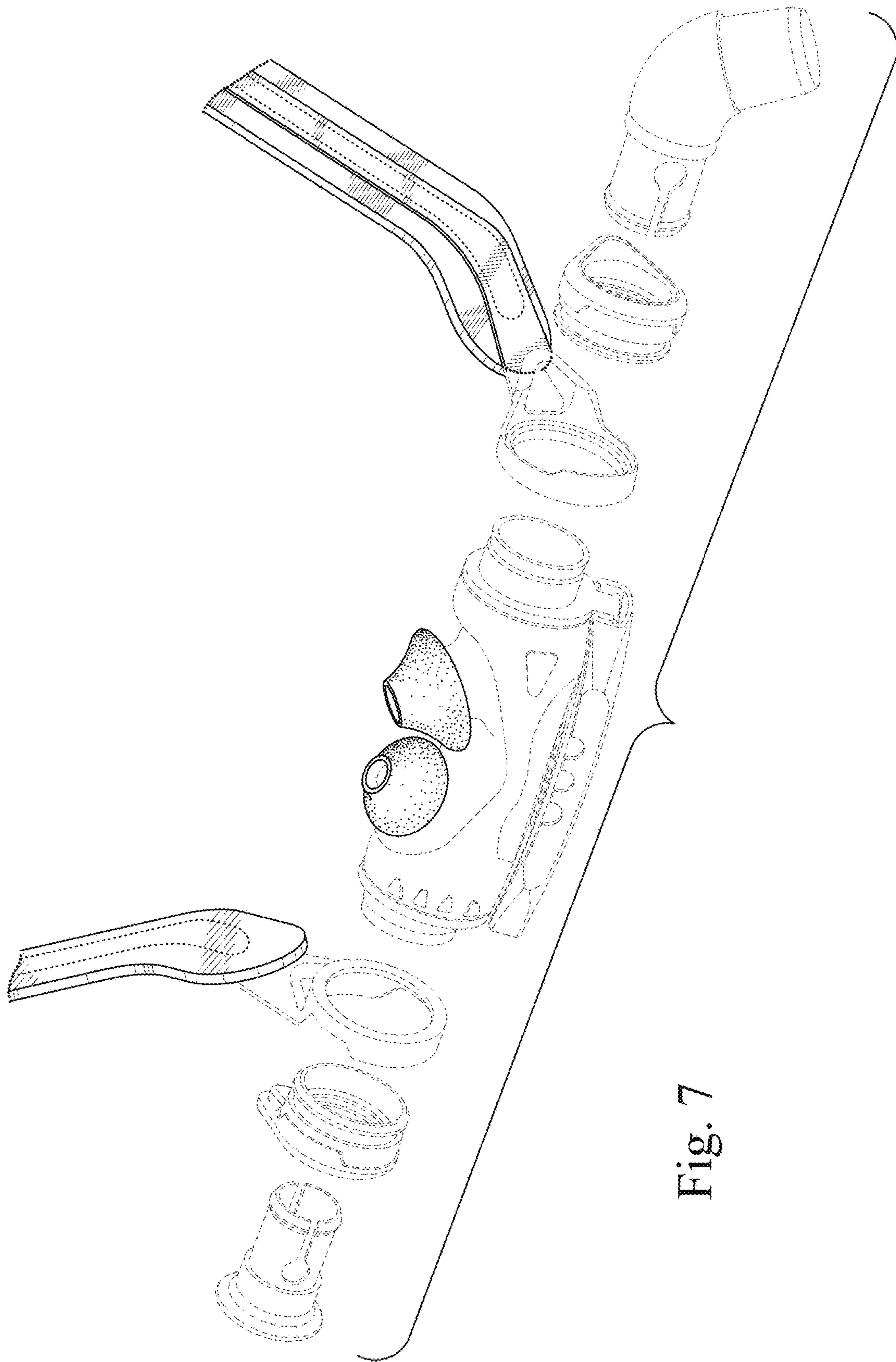

Fig. 7