



US00D800215S

(12) **United States Design Patent**
Sato et al.

(10) **Patent No.:** **US D800,215 S**
(45) **Date of Patent:** **** Oct. 17, 2017**

(54) **PRINTER**

(71) Applicants: **Yukihiko Sato**, Nagoya (JP); **Jiro Suzuki**, Kariya (JP)

(72) Inventors: **Yukihiko Sato**, Nagoya (JP); **Jiro Suzuki**, Kariya (JP)

(73) Assignee: **BROTHER INDUSTRIES, LTD.**, Nagoya (JP)

(**) Term: **14 Years**

(21) Appl. No.: **29/464,324**

(22) Filed: **Aug. 15, 2013**

(30) **Foreign Application Priority Data**

Feb. 15, 2013 (JP) 2013-3005

(51) **LOC (10) Cl.** **14-02**

(52) **U.S. Cl.**
USPC **D18/50**

(58) **Field of Classification Search**
USPC D18/36-37, 50, 54, 54.1, 55;
D14/420-425, 462-470; 400/613,
400/613.1-613.4, 690.1-690.4, 691-694
(Continued)

(56) **References Cited**

U.S. PATENT DOCUMENTS

D632,732 S 2/2011 Park et al.
D641,397 S * 7/2011 Kim et al. D18/55
(Continued)

FOREIGN PATENT DOCUMENTS

CN 301860743 S 3/2012
CN 301883096 S 4/2012

OTHER PUBLICATIONS

Dec. 6, 2016 Office Action issued in U.S. Appl. No. 29/464,337.

Primary Examiner — Cathy Anne MacCormac

(74) *Attorney, Agent, or Firm* — Oliff PLC

(57) **CLAIM**

The ornamental design for a printer, as shown and described.

DESCRIPTION

FIG. 1 is a perspective view of a printer;
FIG. 2 is a front view thereof;
FIG. 3 is a top view thereof;
FIG. 4 is a right-side view thereof;
FIG. 5 is a left-side view thereof;
FIG. 6 is a rear view thereof;
FIG. 7 is a bottom view thereof;
FIG. 8 is a detail view of the left-side encircled portion shown in FIG. 2;
FIG. 9 is a detail view of the right-side encircled portion shown in FIG. 2;
FIG. 10 is a detail view of the left-side encircled portion shown in FIG. 3;
FIG. 11 is a detail view of the right-side encircled portion shown in FIG. 3;
FIG. 12 is a detail view of the left-side encircled portion shown in FIG. 4;
FIG. 13 is a detail view of the right-side encircled portion shown in FIG. 4;
FIG. 14 is a detail view of the left-side encircled portion shown in FIG. 5;
FIG. 15 is a detail view of the right-side encircled portion shown in FIG. 5;
FIG. 16 is a detail view of the left-side encircled portion shown in FIG. 6; and,
FIG. 17 is a detail view of the right-side encircled portion shown in FIG. 6.

The evenly spaced broken lines depict environmental subject matter only and form no part of the claimed design. The dot-dash broken lines form rectangular shaped boxes around portions of FIGS. 2-6 and depict areas as detail views in FIGS. 8-17, the dot-dash broken lines form no part of the claimed design.

1 Claim, 14 Drawing Sheets

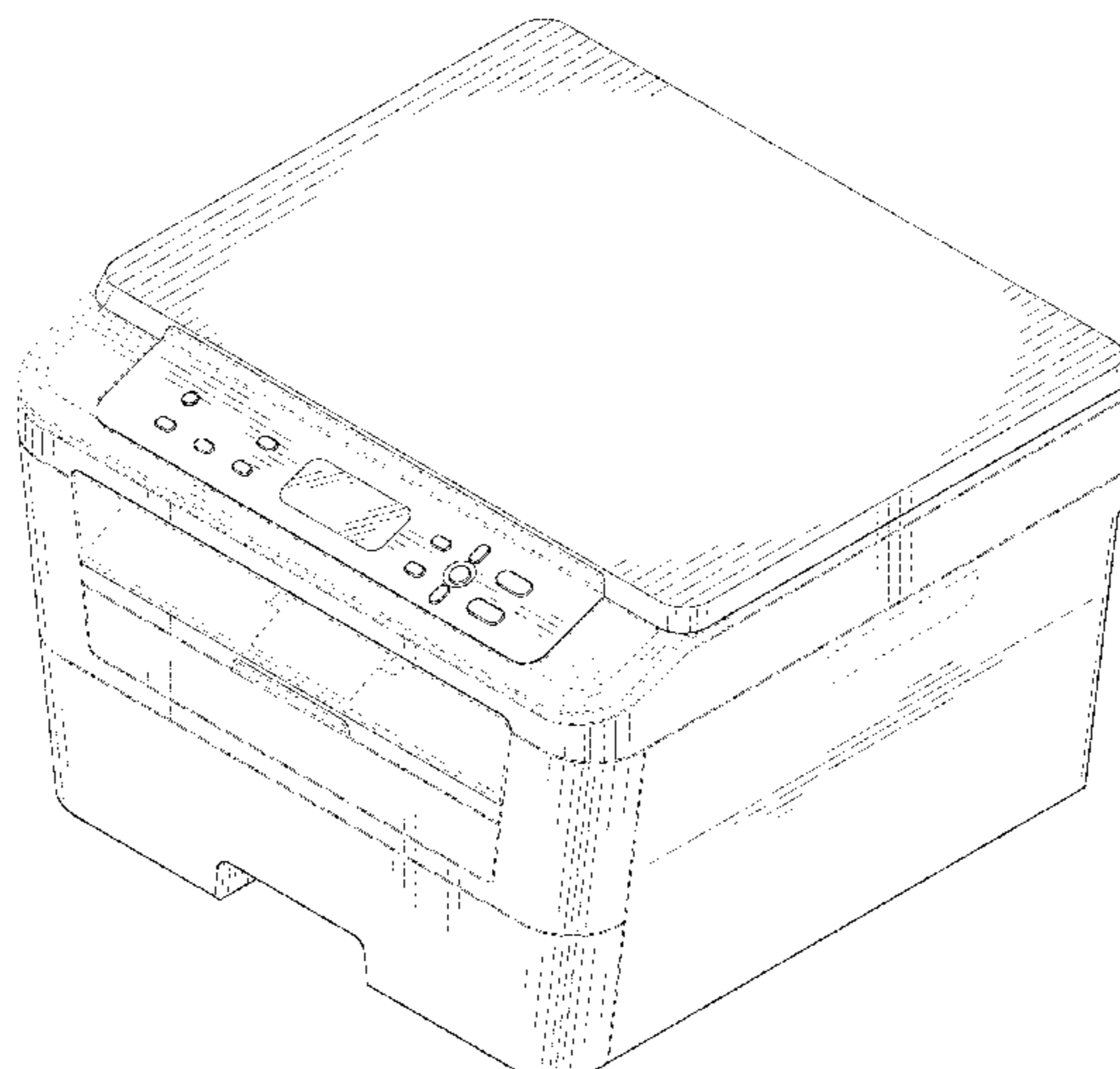

(58) **Field of Classification Search**

CPC B41J 3/36; B41J 9/26; B41J 15/00; B41J
29/02; B41J 29/13; B41J 35/36; B65H
35/06; G03G 21/00; G03G 21/16; G03G
15/00; G06F 3/12; G06K 15/14

See application file for complete search history.

(56) **References Cited**

U.S. PATENT DOCUMENTS

D645,078 S *	9/2011	Kim et al.	D18/50
D647,130 S *	10/2011	Kim et al.	D18/50
D661,346 S *	6/2012	Suzuki et al.	D18/55
D662,974 S	7/2012	Suzuki et al.		
D667,490 S *	9/2012	Inoue et al.	D18/55

* cited by examiner

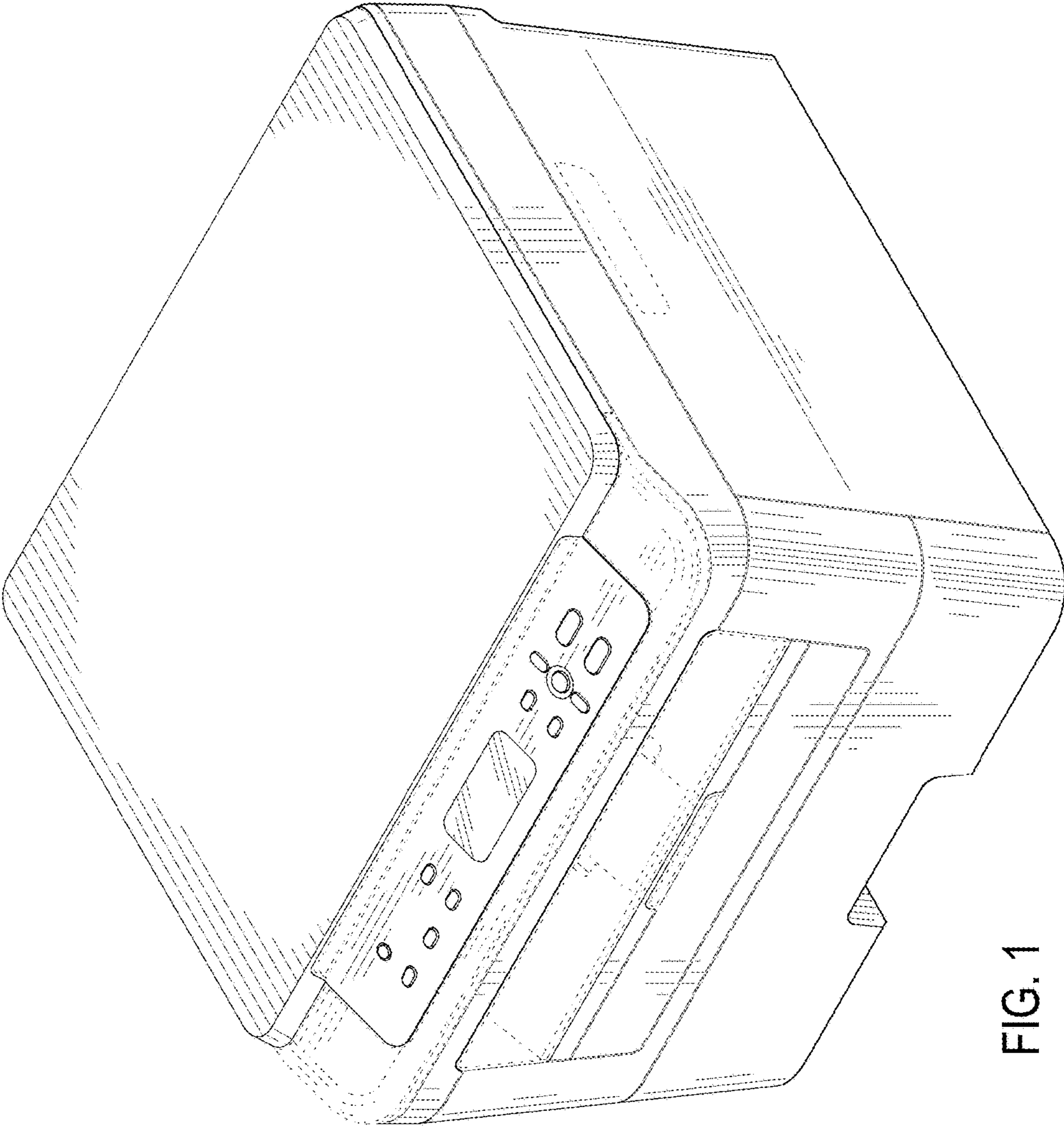

FIG. 1

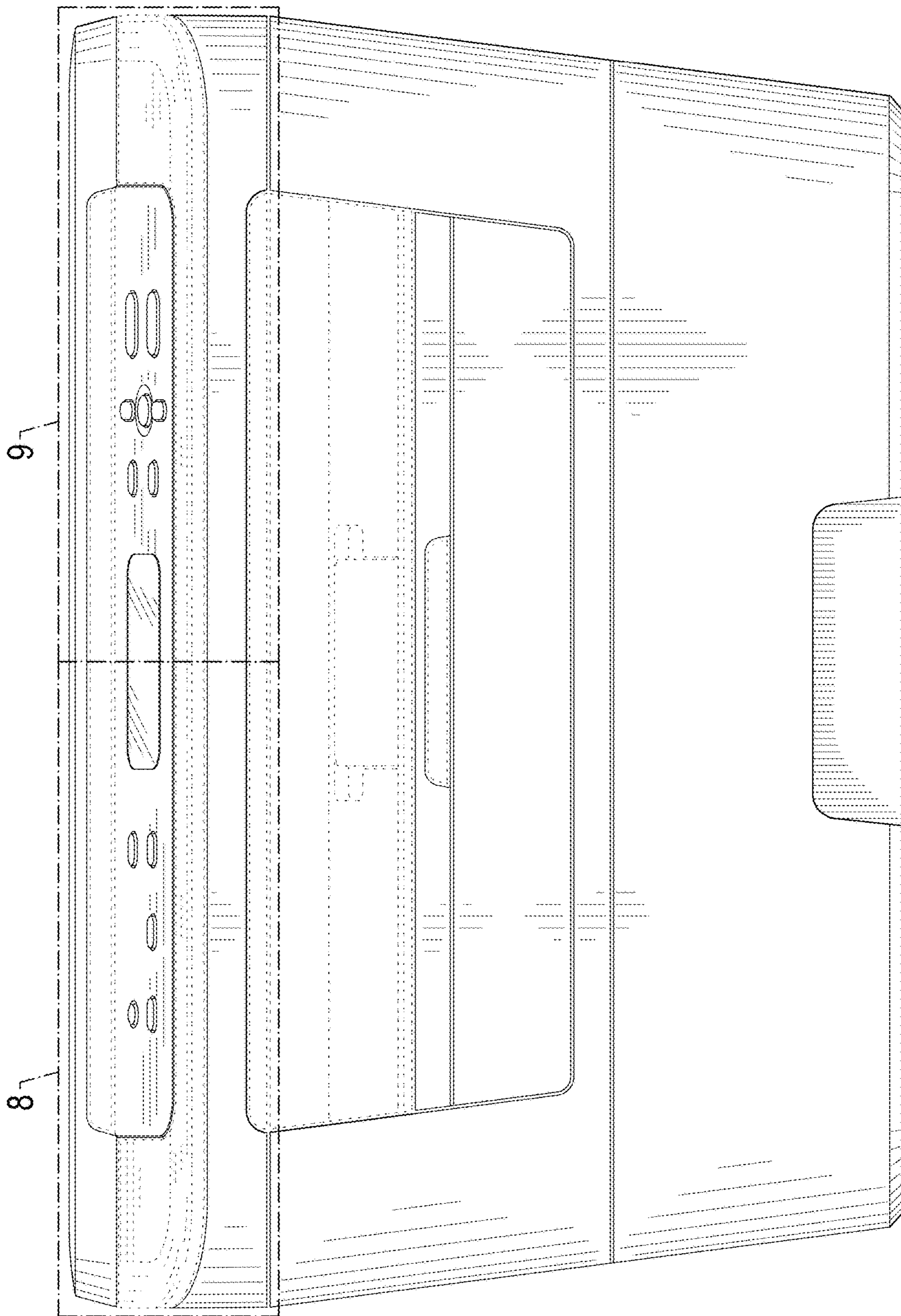

FIG. 2

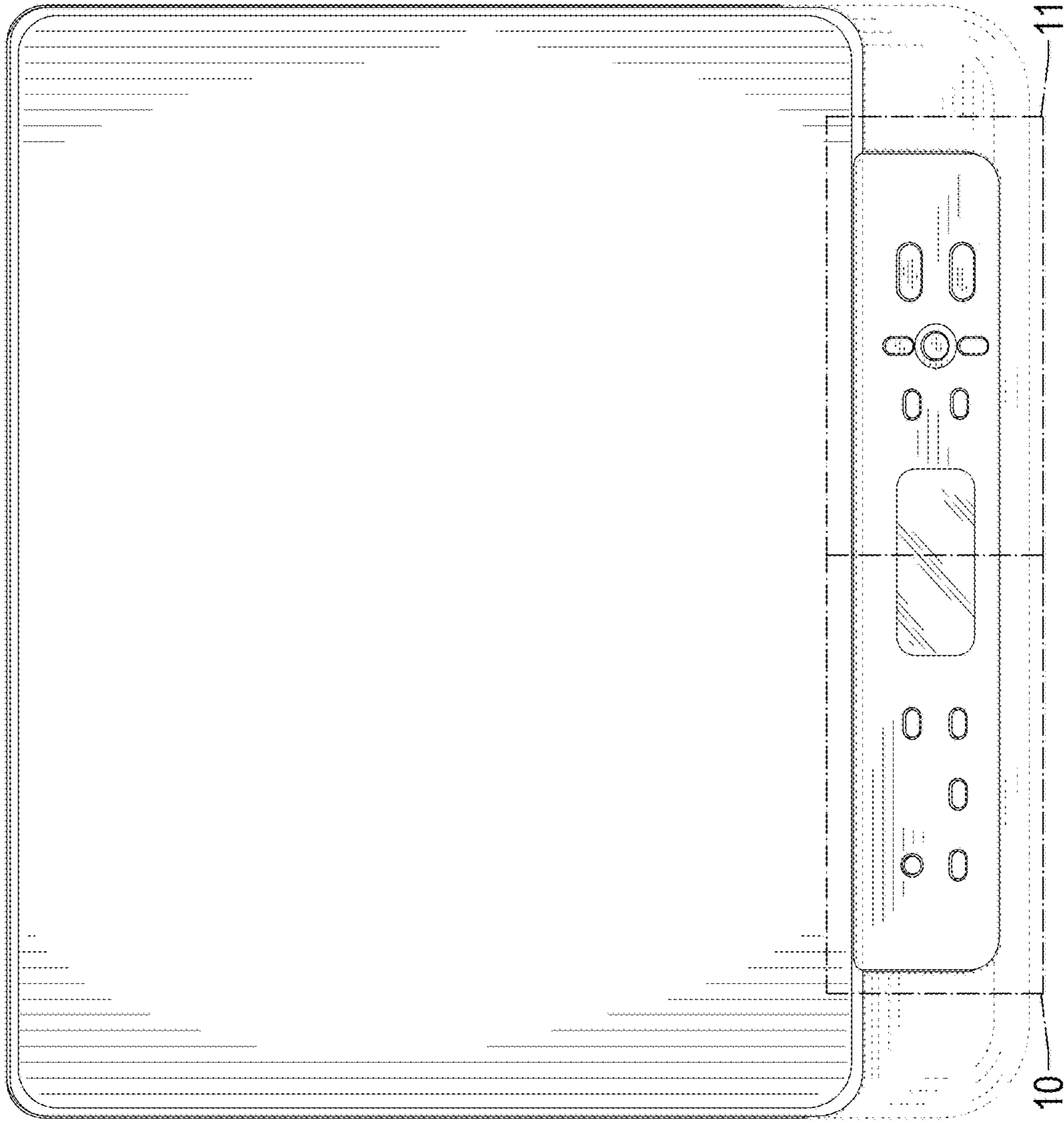

FIG. 3

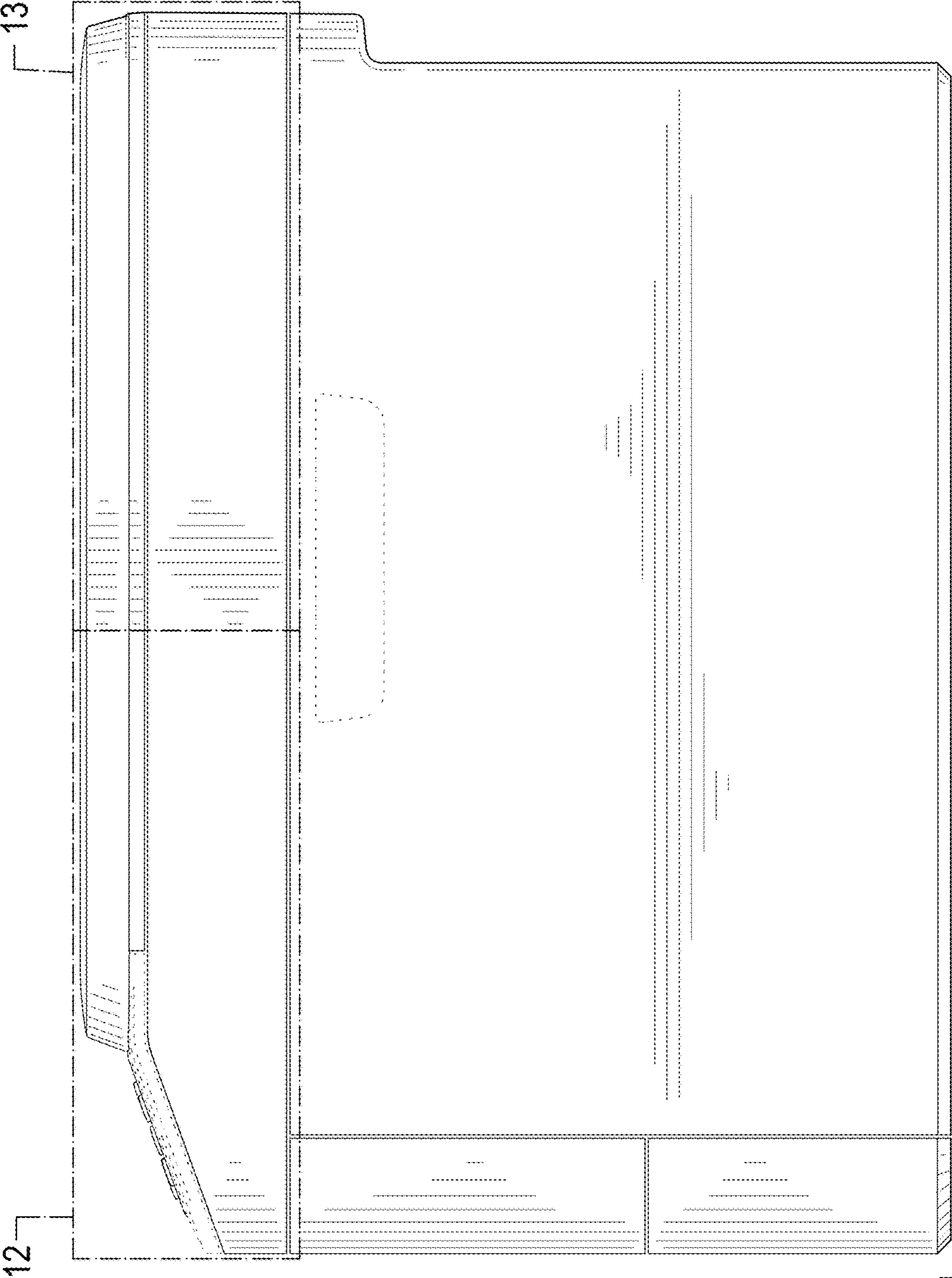

FIG. 4

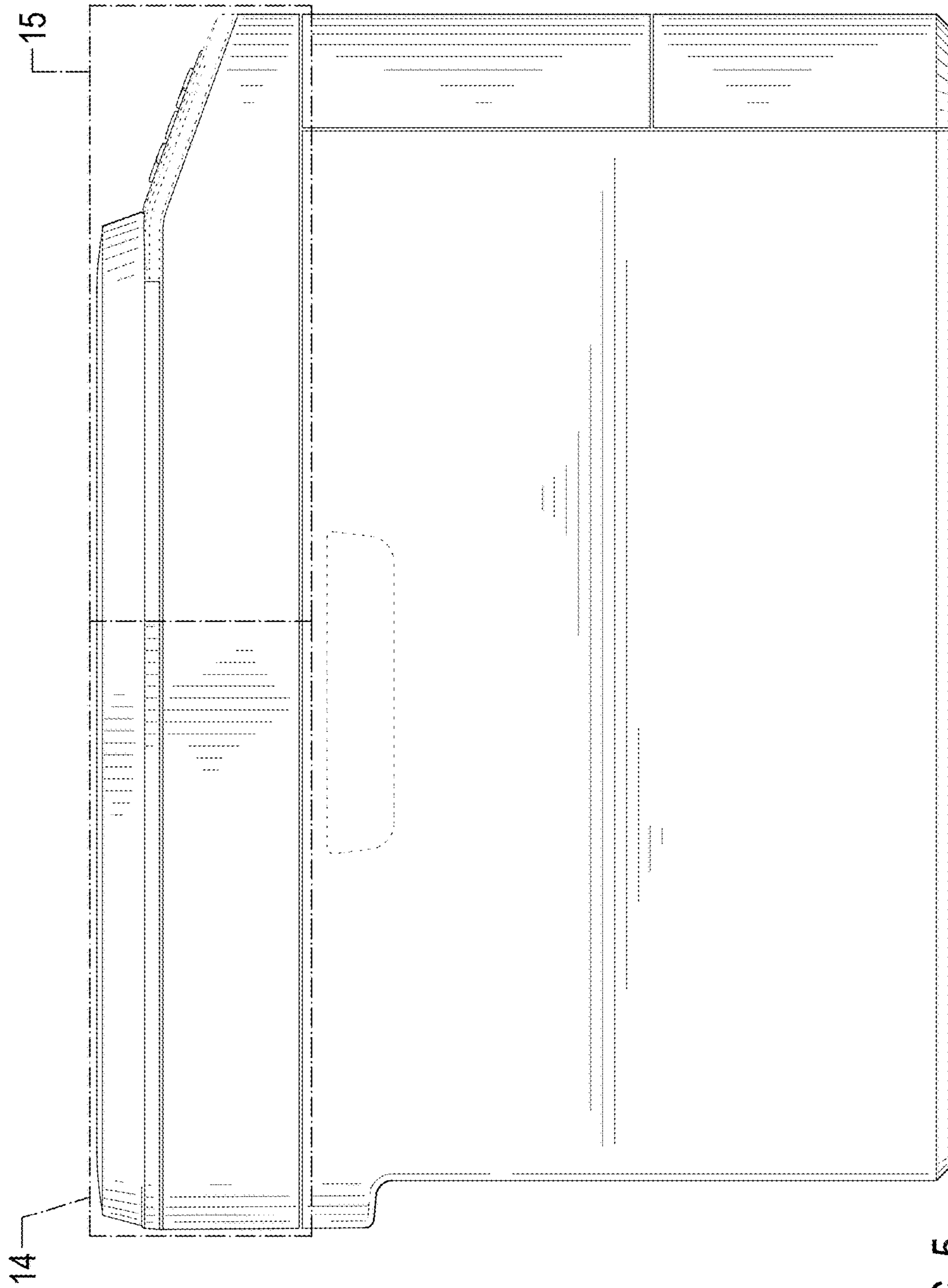

FIG. 5

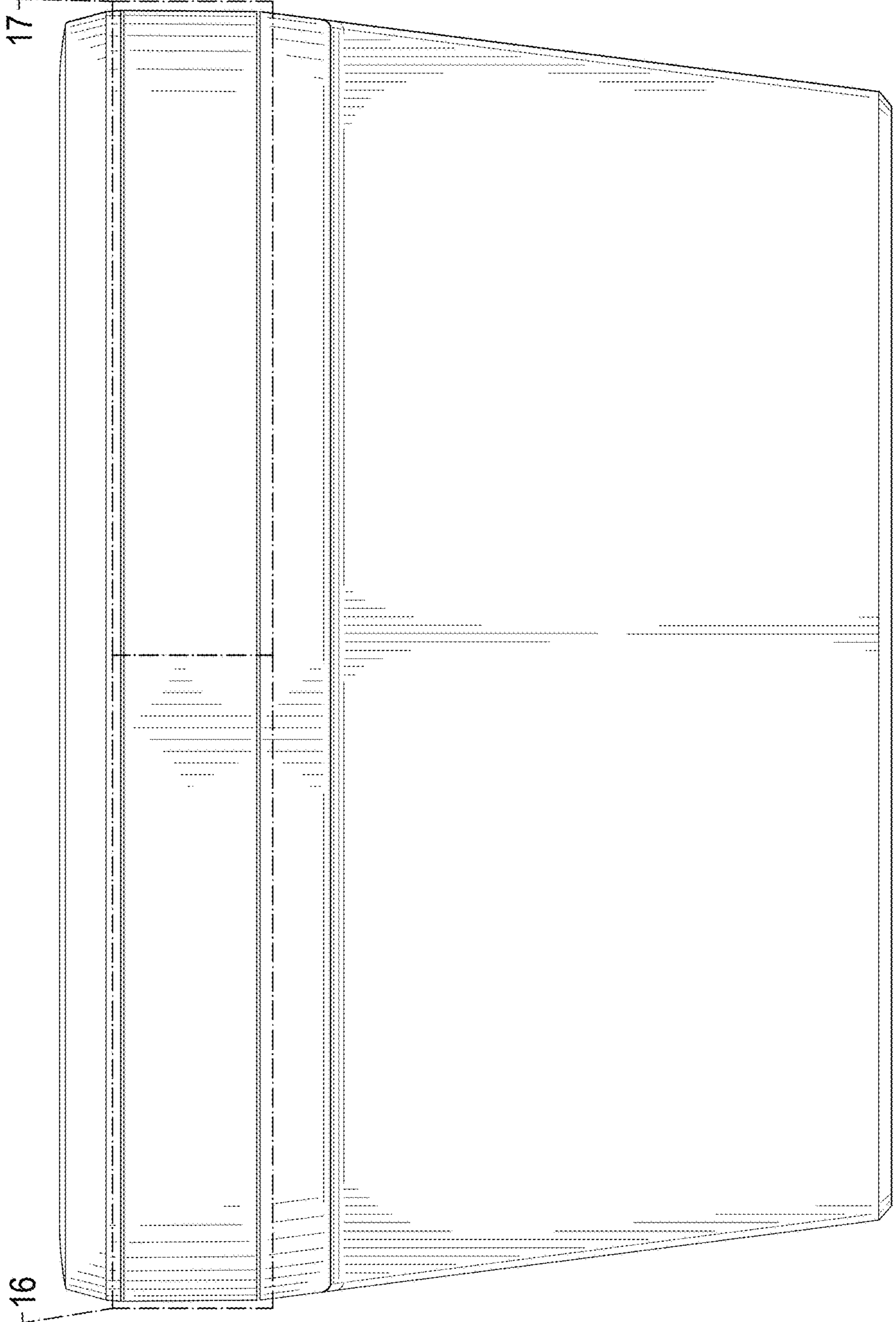

FIG. 6

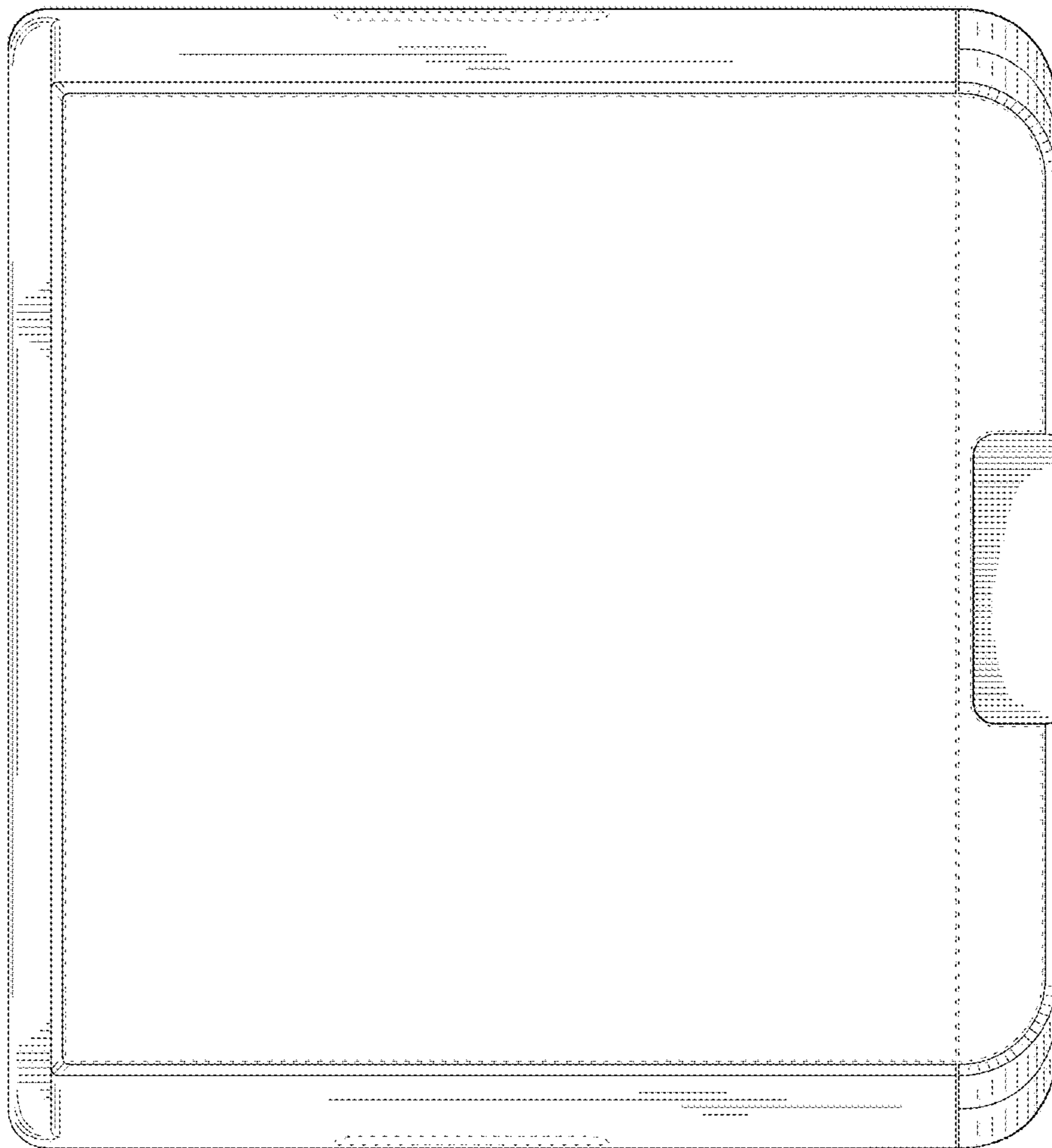

FIG. 7

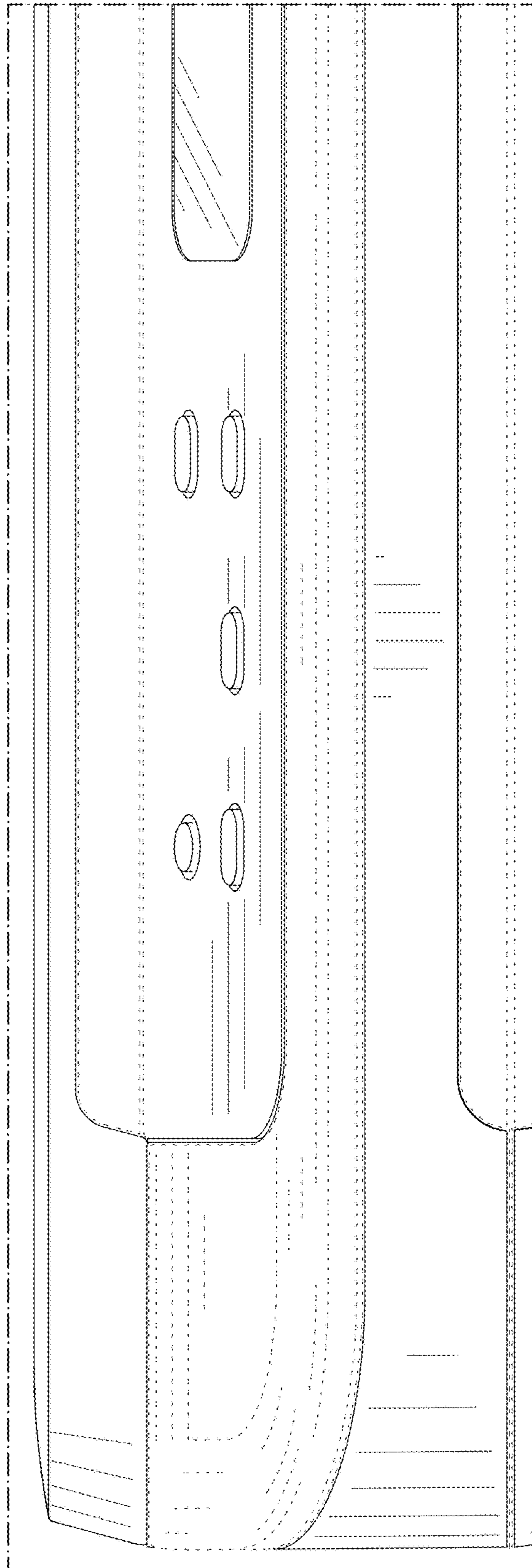

FIG. 8

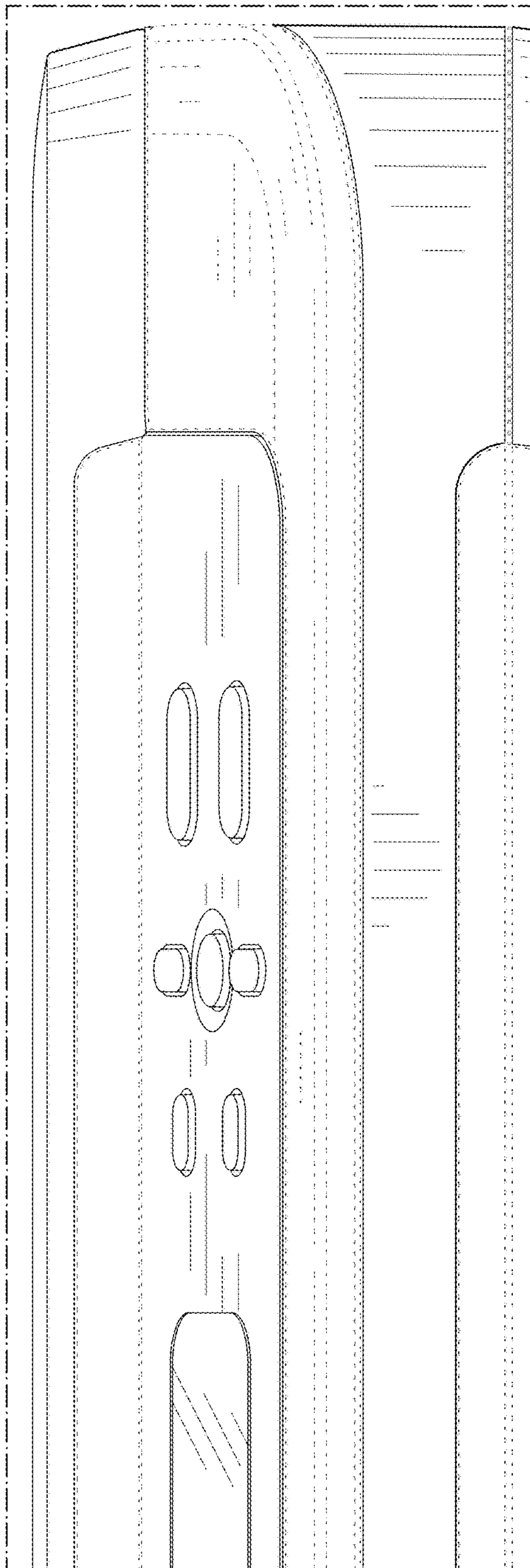

FIG. 9

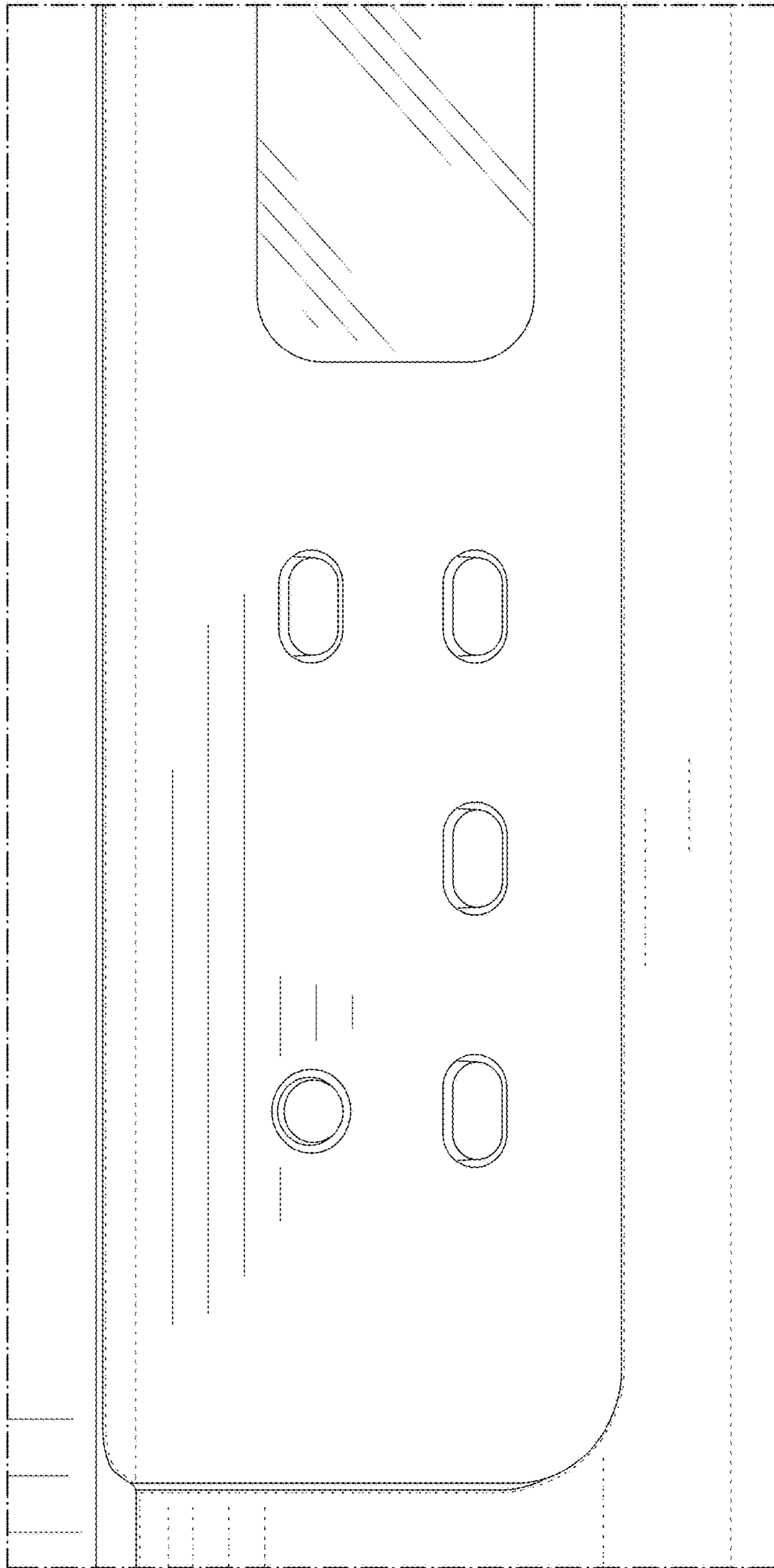

FIG. 10

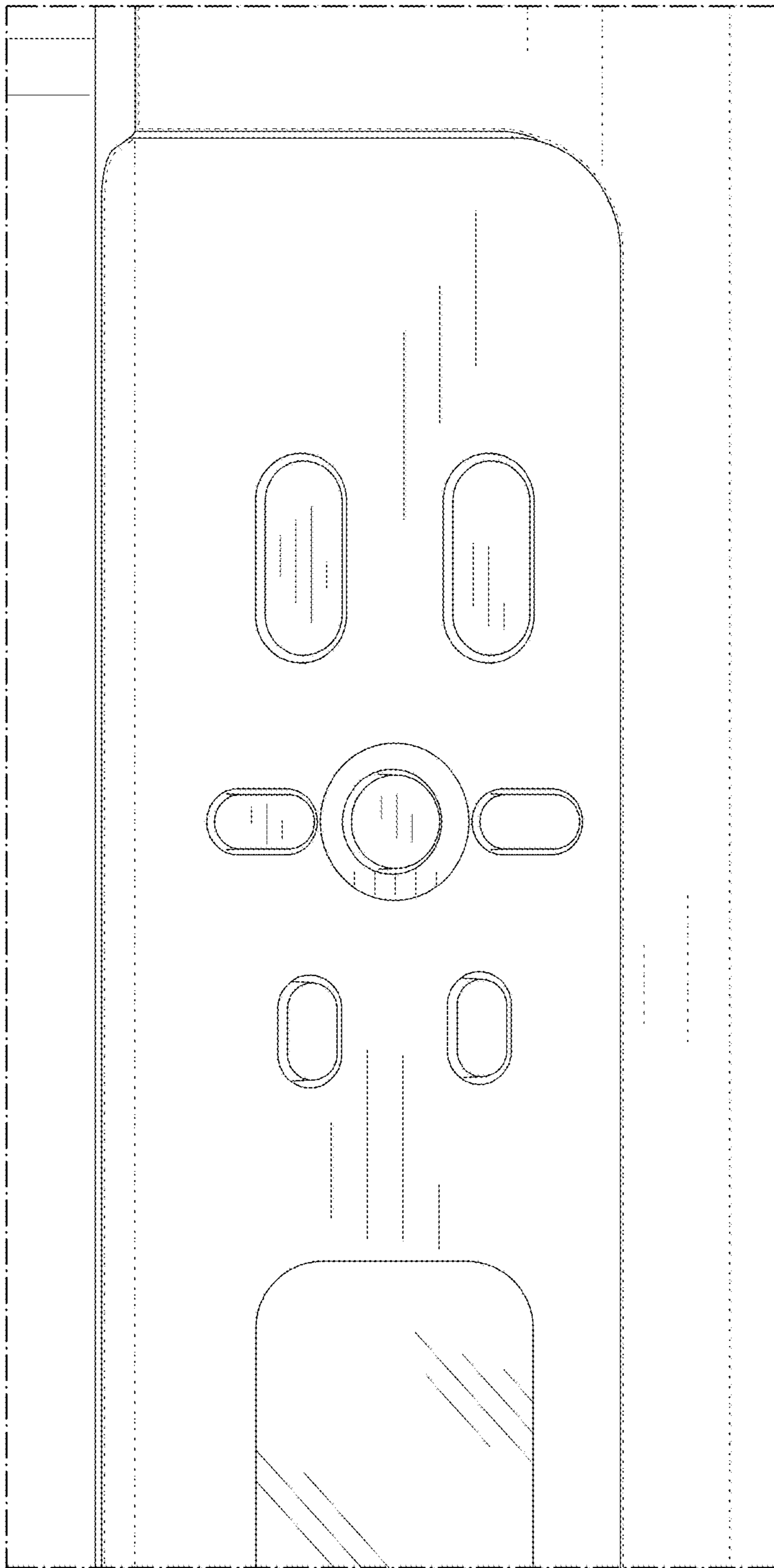

FIG. 11

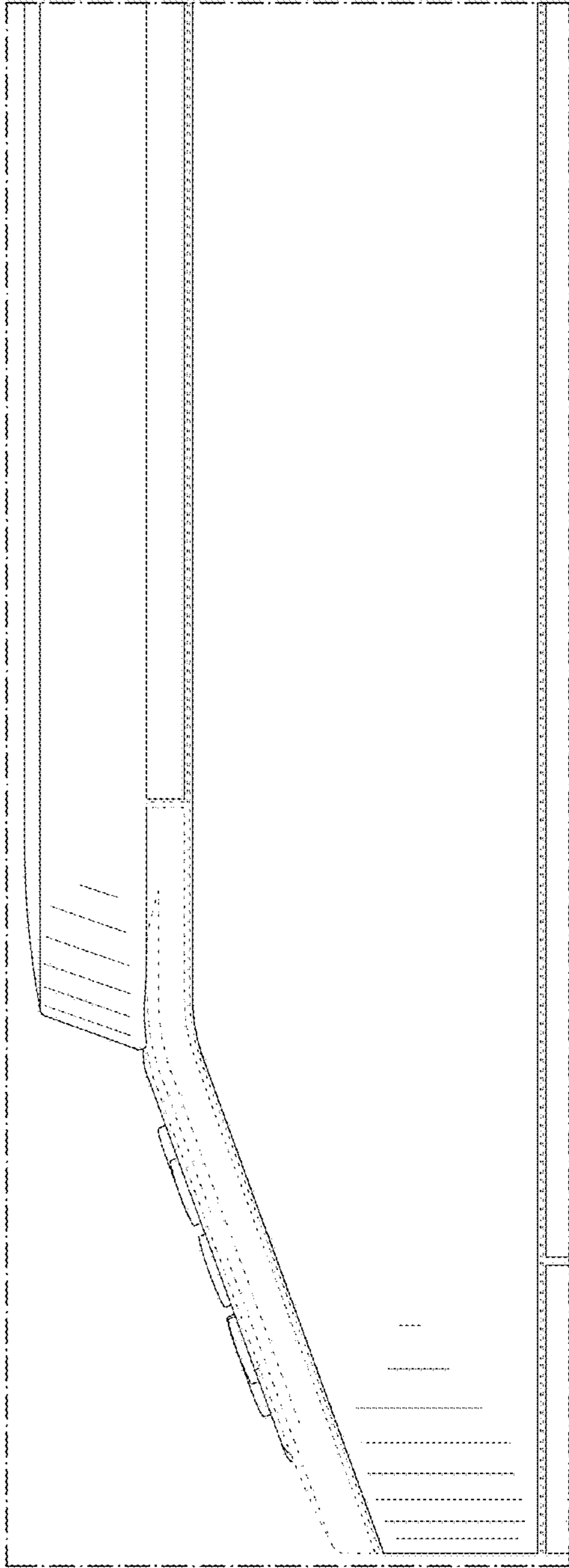

FIG. 12

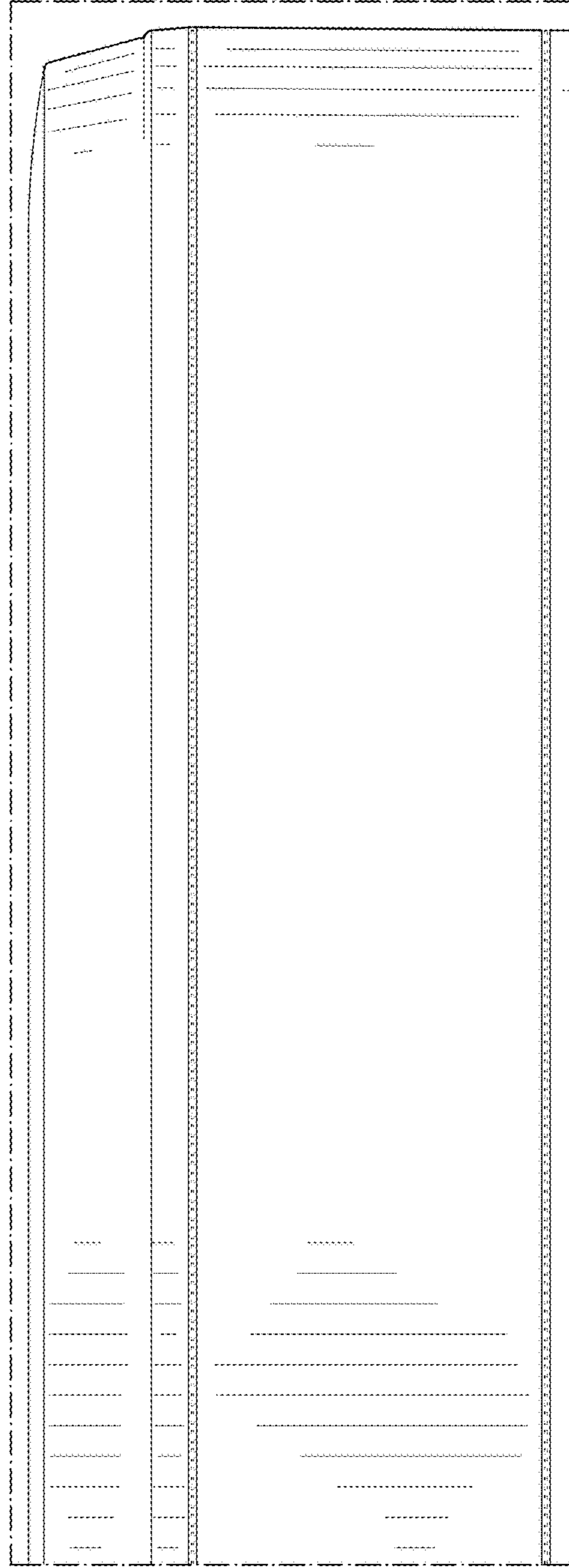

FIG. 13

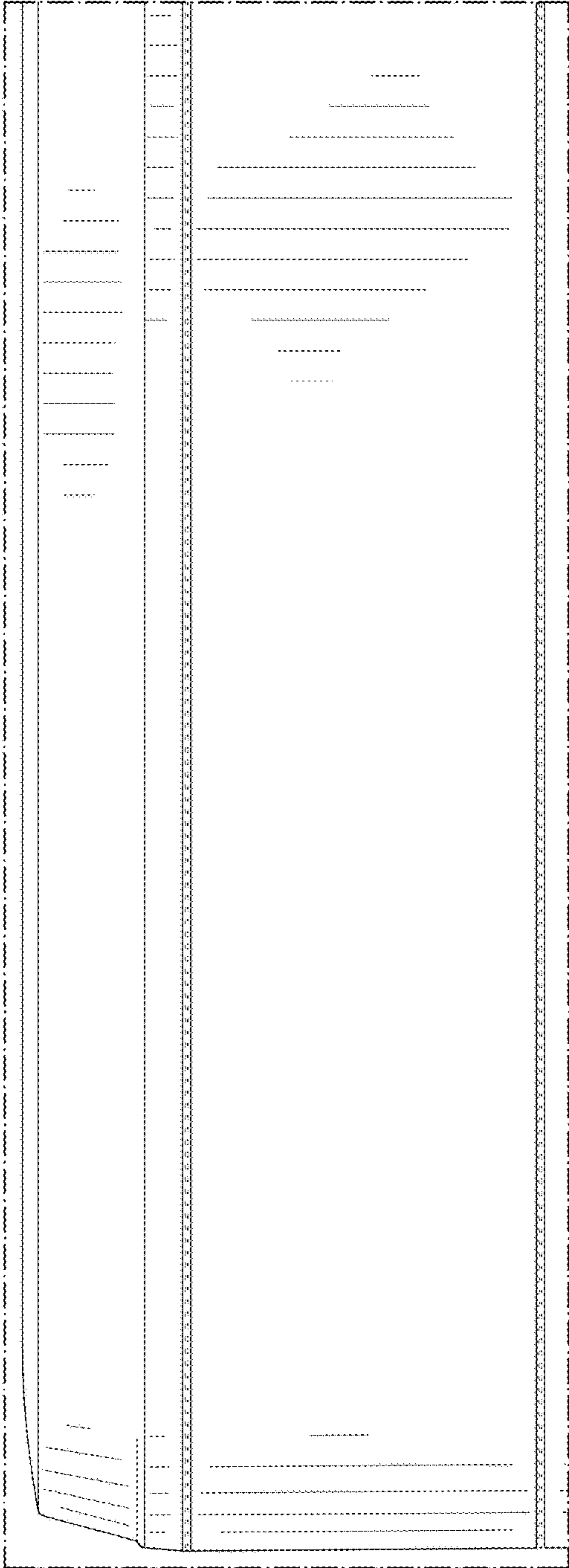

FIG. 14

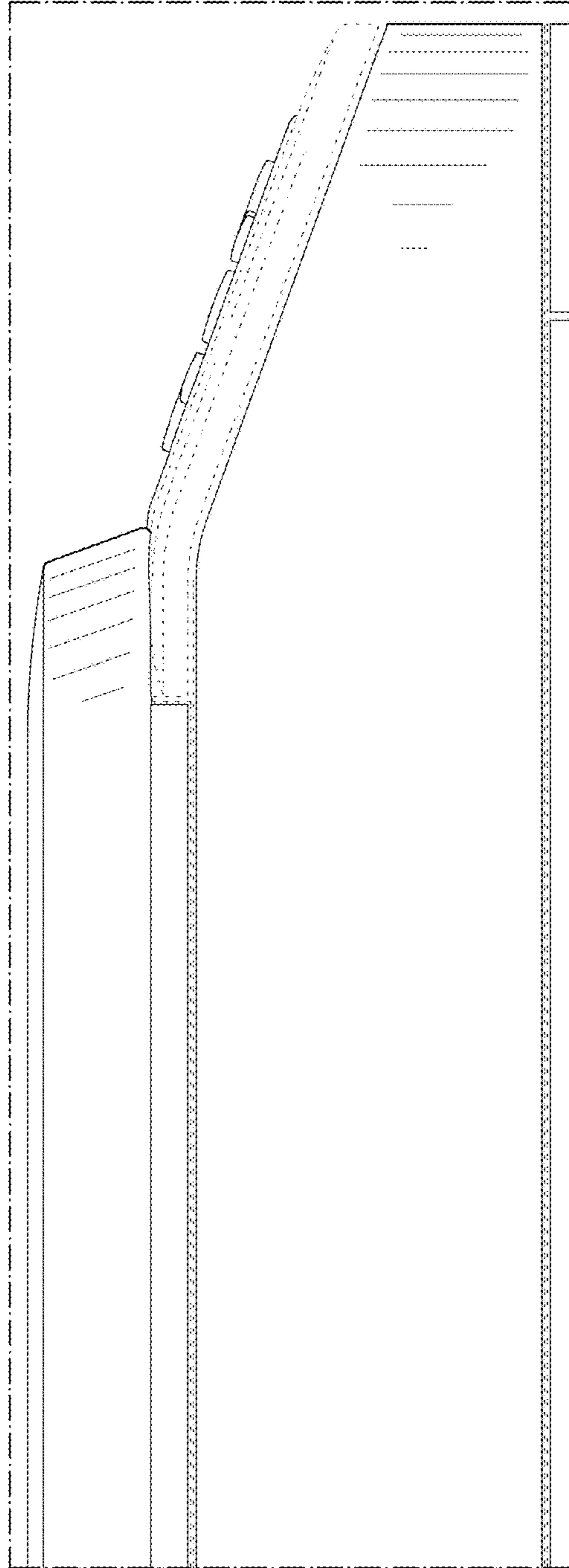

FIG. 15

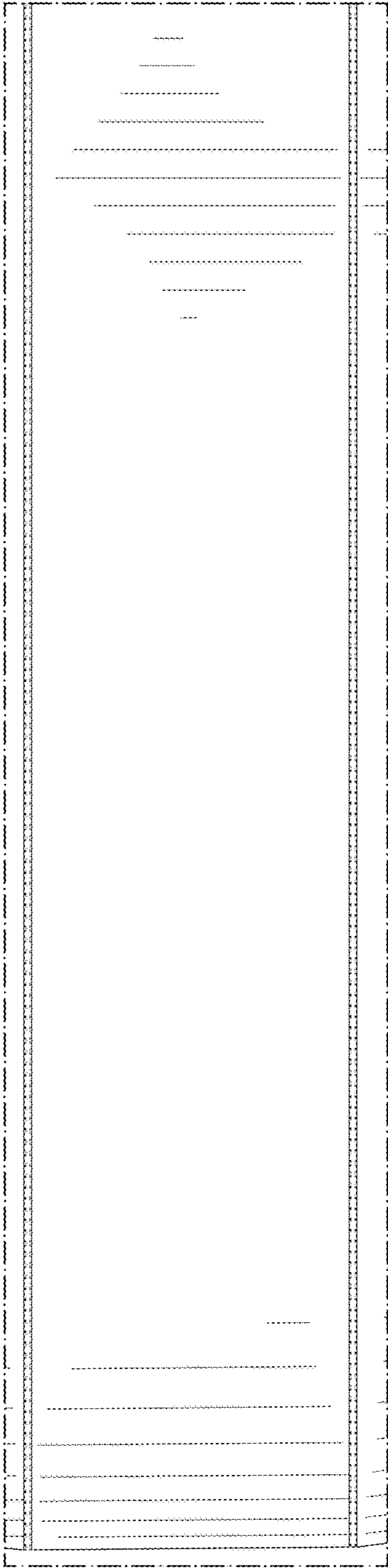

FIG. 16

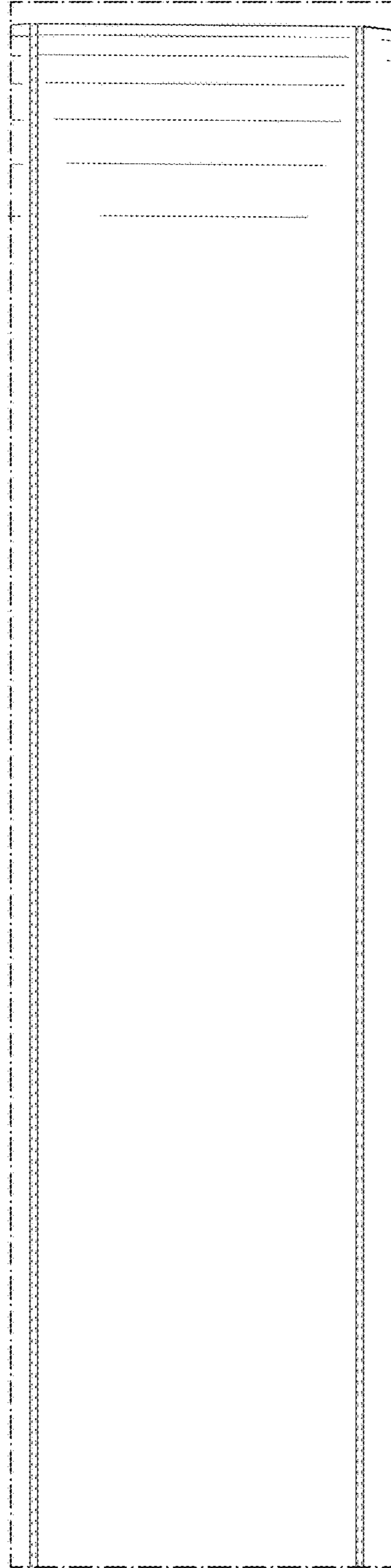

FIG. 17