



US00D800214S

(12) **United States Design Patent** (10) **Patent No.:** **US D800,214 S**  
**Sato et al.** (45) **Date of Patent:** **\*\* Oct. 17, 2017**

(54) **PRINTER**

OTHER PUBLICATIONS

(71) Applicants: **Yukihiko Sato**, Nagoya (JP); **Jiro Suzuki**, Kariya (JP)

Dec. 2, 2016 U.S. Office Action Issued in U.S. Appl. No. 29/464,359.

(72) Inventors: **Yukihiko Sato**, Nagoya (JP); **Jiro Suzuki**, Kariya (JP)

\* cited by examiner

(73) Assignee: **BROTHER INDUSTRIES, LTD.**, Nagoya (JP)

*Primary Examiner* — Cathy Anne MacCormac

(74) *Attorney, Agent, or Firm* — Oliff PLC

(\*\*) Term: **14 Years**

(57) **CLAIM**

The ornamental design for a printer, as shown and described.

(21) Appl. No.: **29/464,262**

**DESCRIPTION**

(22) Filed: **Aug. 14, 2013**

(30) **Foreign Application Priority Data**

Feb. 15, 2013 (JP) ..... 2013-3006

(51) **LOC (10) Cl.** ..... **14-02**

(52) **U.S. Cl.**  
USPC ..... **D18/50**

(58) **Field of Classification Search**  
USPC ..... D18/36-37, 50, 54, 54.1, 55;  
D14/420-425, 462-470; 400/613,  
400/613.1-613.4, 690.1-690.4, 691-694  
CPC ..... B41J 3/36; B41J 9/26; B41J 15/00; B41J  
29/02; B41J 29/13; B41J 35/36; B65H  
35/06; G03G 21/00; G03G 21/16; G03G  
15/00; G06F 3/12; G06K 15/14  
See application file for complete search history.

FIG. 1 is a perspective view of a printer;  
FIG. 2 is a front view thereof;  
FIG. 3 is a top view thereof;  
FIG. 4 is a right-side view thereof;  
FIG. 5 is a left-side view thereof;  
FIG. 6 is a rear view thereof;  
FIG. 7 is a bottom view thereof;  
FIG. 8 is a detail view of the encircled portion 8 in FIG. 2;  
FIG. 9 is a detail view of the encircled portion 9 in FIG. 2;  
FIG. 10 is a detail view of the encircled portion 10 in FIG. 4;  
FIG. 11 is a detail view of the encircled portion 11 in FIG. 4;  
FIG. 12 is a detail view of the encircled portion 12 in FIG. 5;  
FIG. 13 is a detail view of the encircled portion 13 in FIG. 5;  
FIG. 14 is a detail view of the encircled portion 14 in FIG. 6; and,  
FIG. 15 is a detail view of the encircled portion 15 in FIG. 6.

(56) **References Cited**

U.S. PATENT DOCUMENTS

D633,556 S 3/2011 Park et al.  
D661,346 S 6/2012 Suzuki et al.  
D662,974 S \* 7/2012 Suzuki et al. .... D18/55  
D673,603 S 1/2013 Suzuki et al.

The evenly spaced broken lines depict environmental subject matter only and form no part of the claimed design. The dot-dash broken lines form rectangular shaped boxes around portions of FIGS. 2 and 4-6 and depict areas as detail views in FIGS. 8-15, the dot-dash broken lines form no part of the claimed design.

**1 Claim, 11 Drawing Sheets**

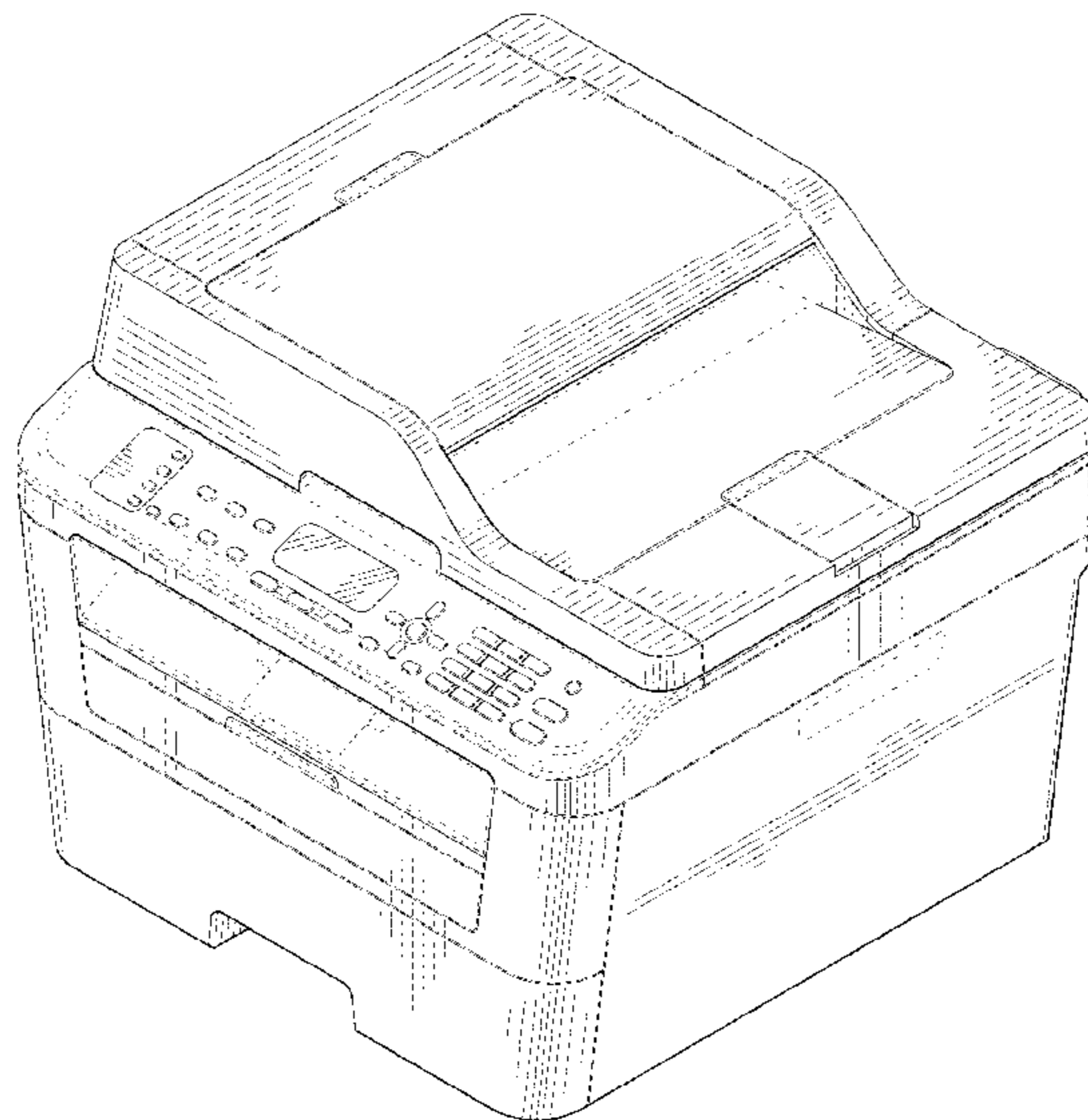

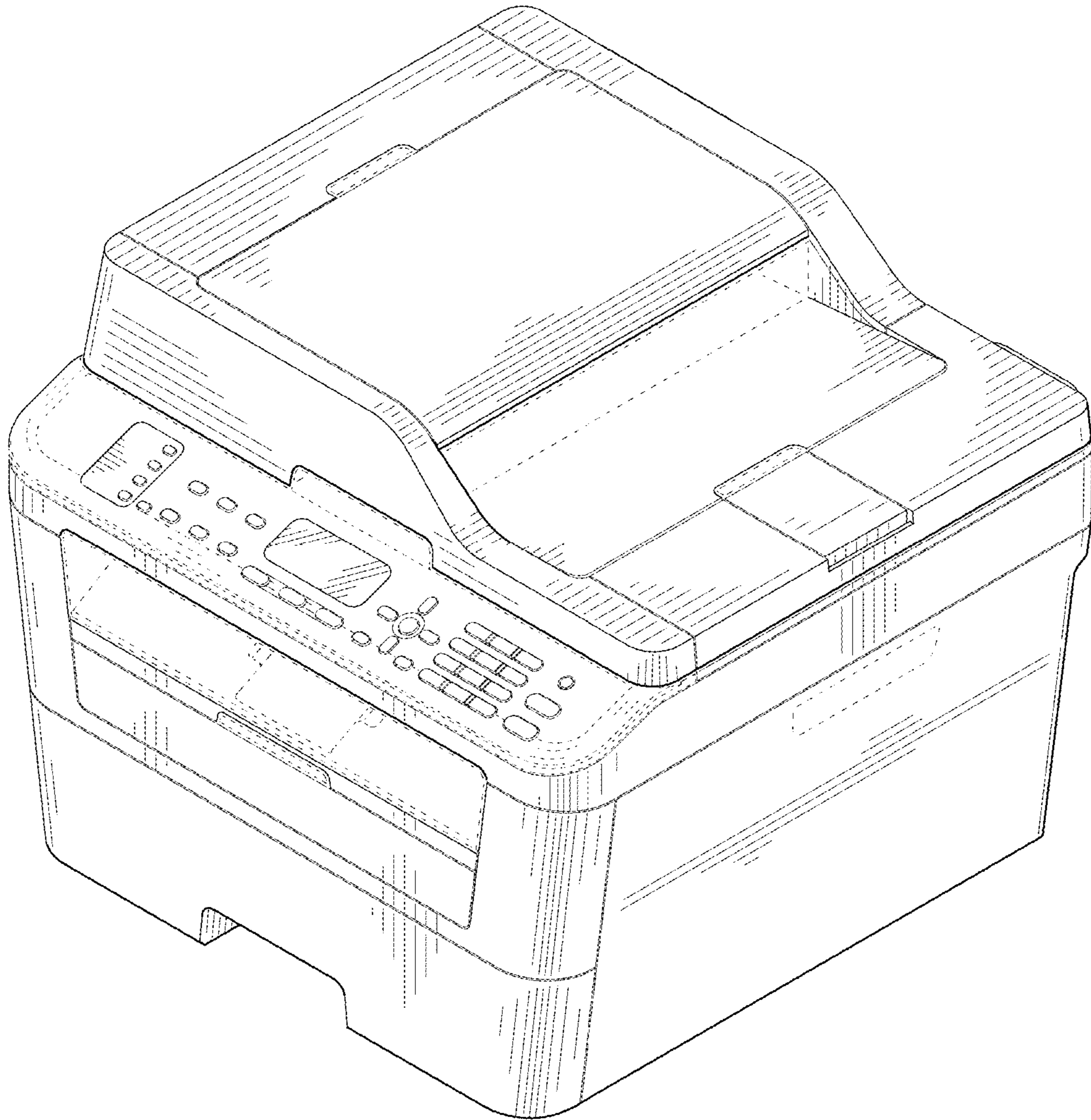

FIG. 1

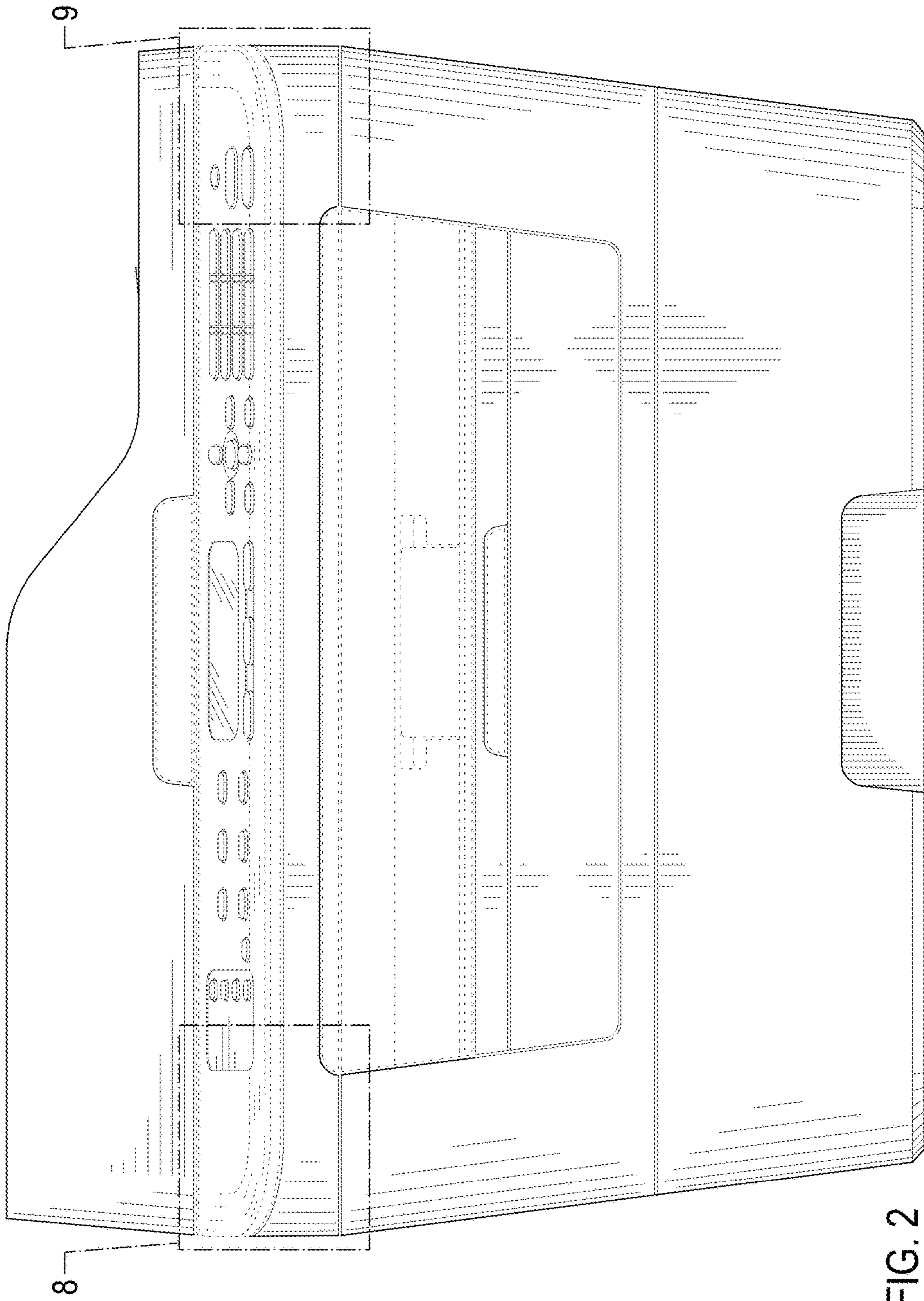

FIG. 2

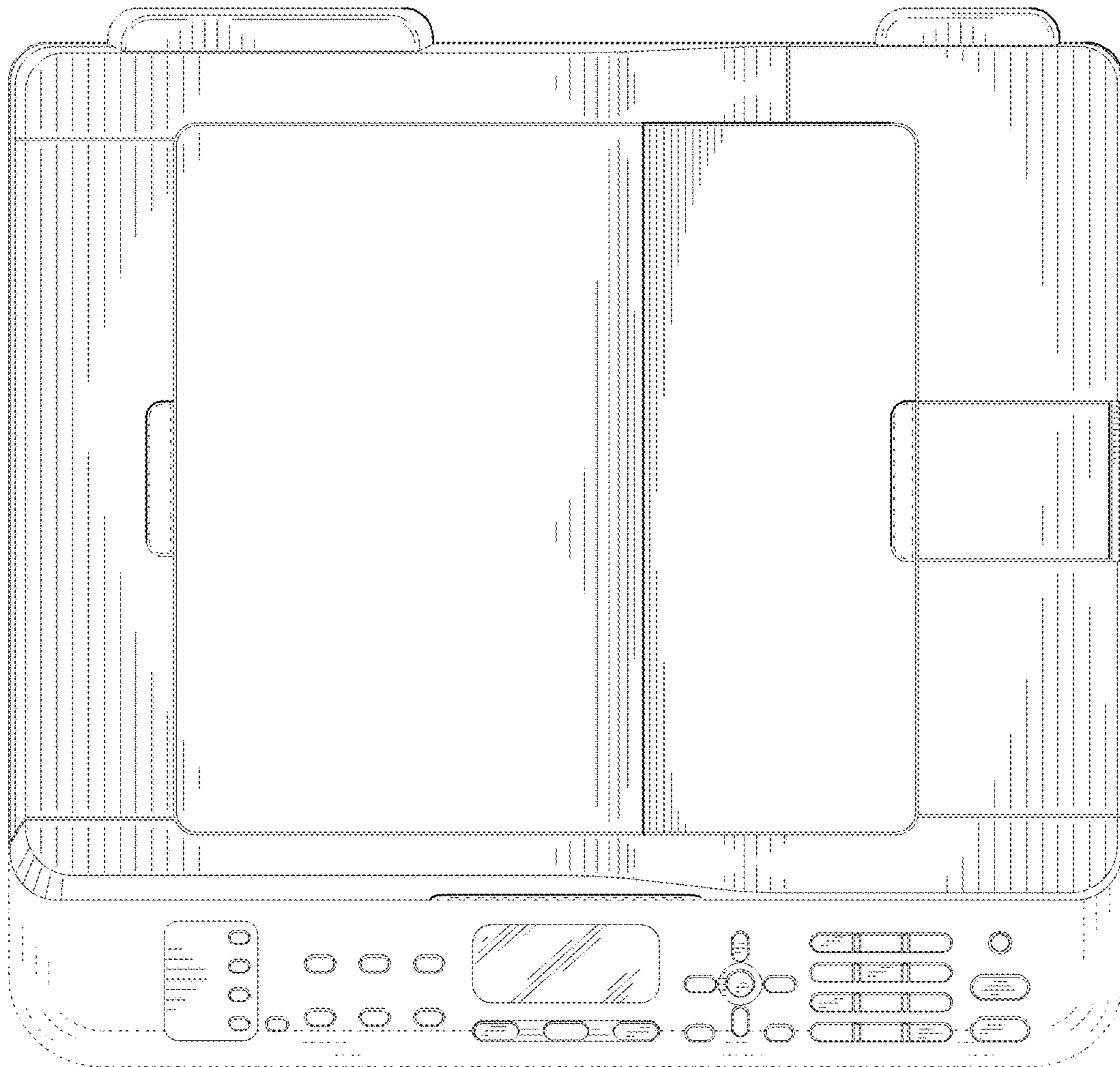

FIG. 3

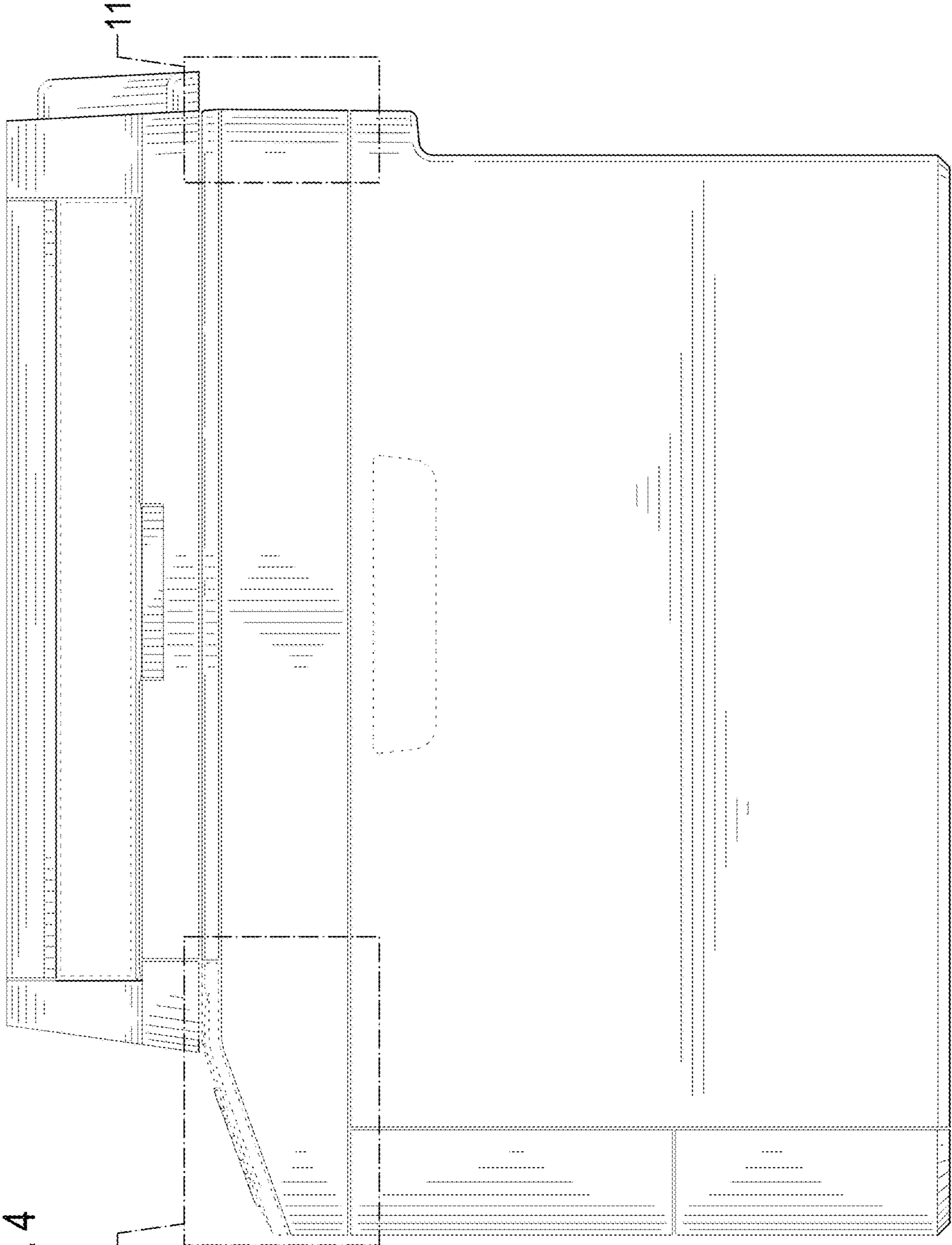

FIG. 4

10

11

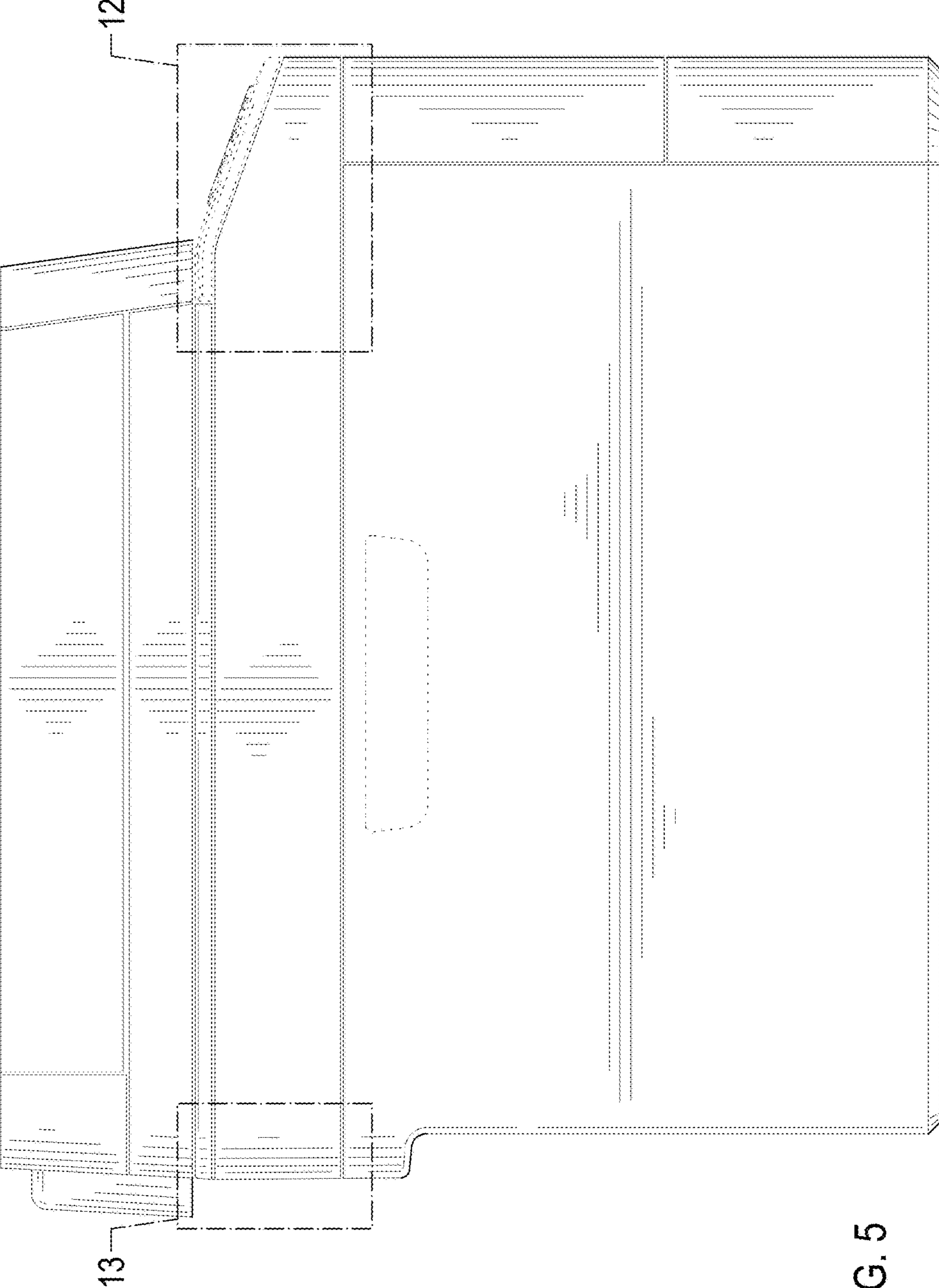

FIG. 5

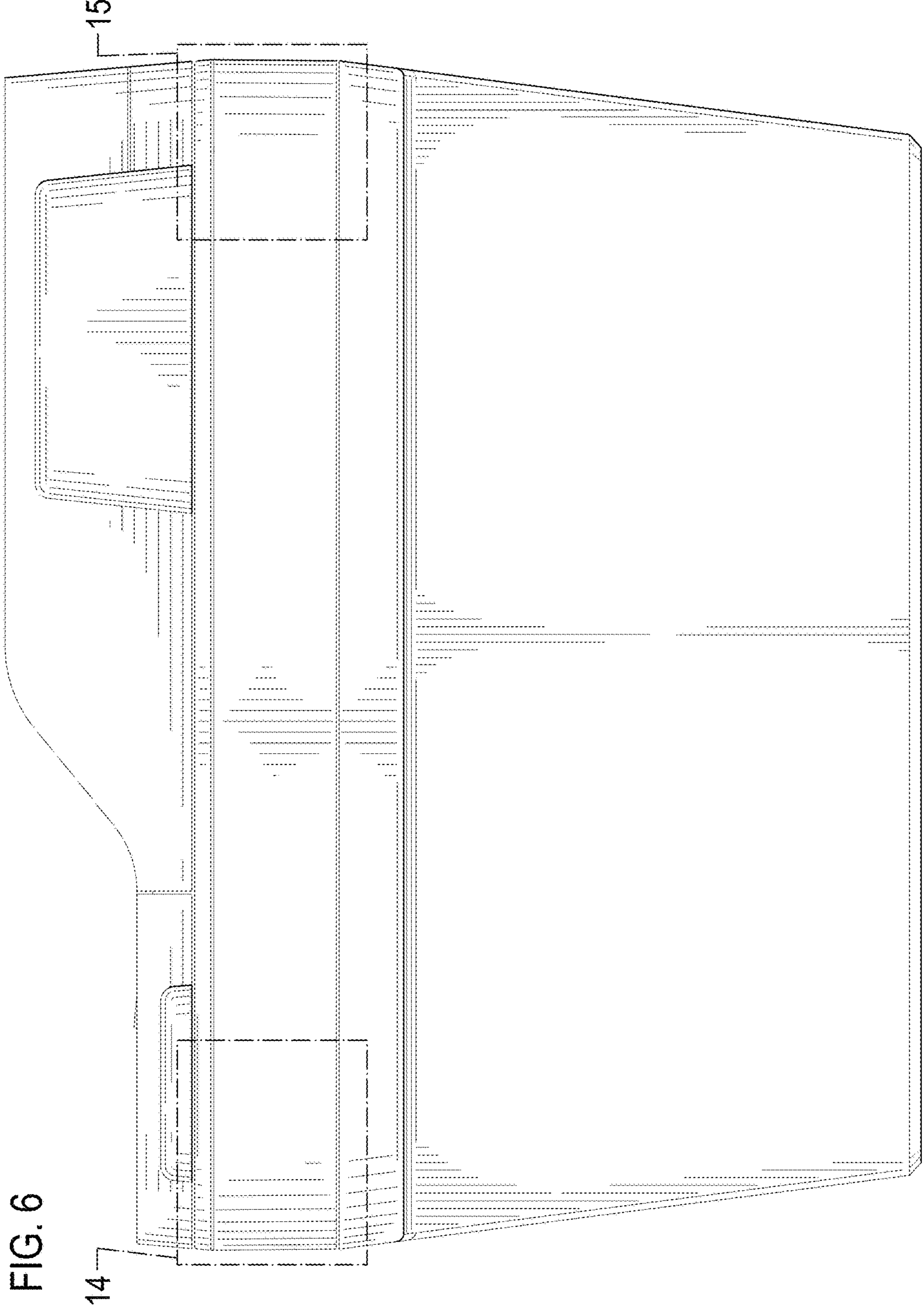

FIG. 6

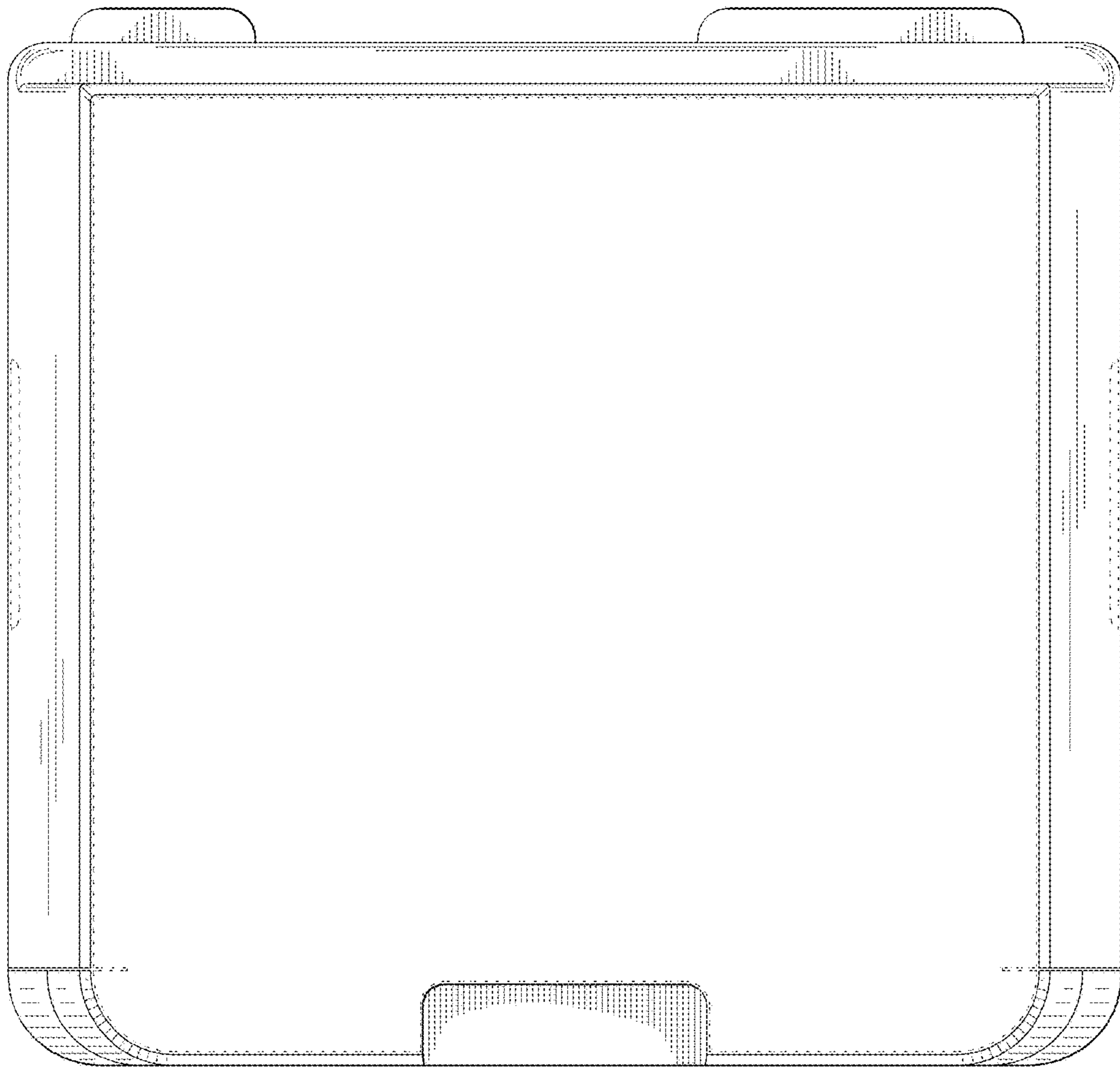

FIG. 7



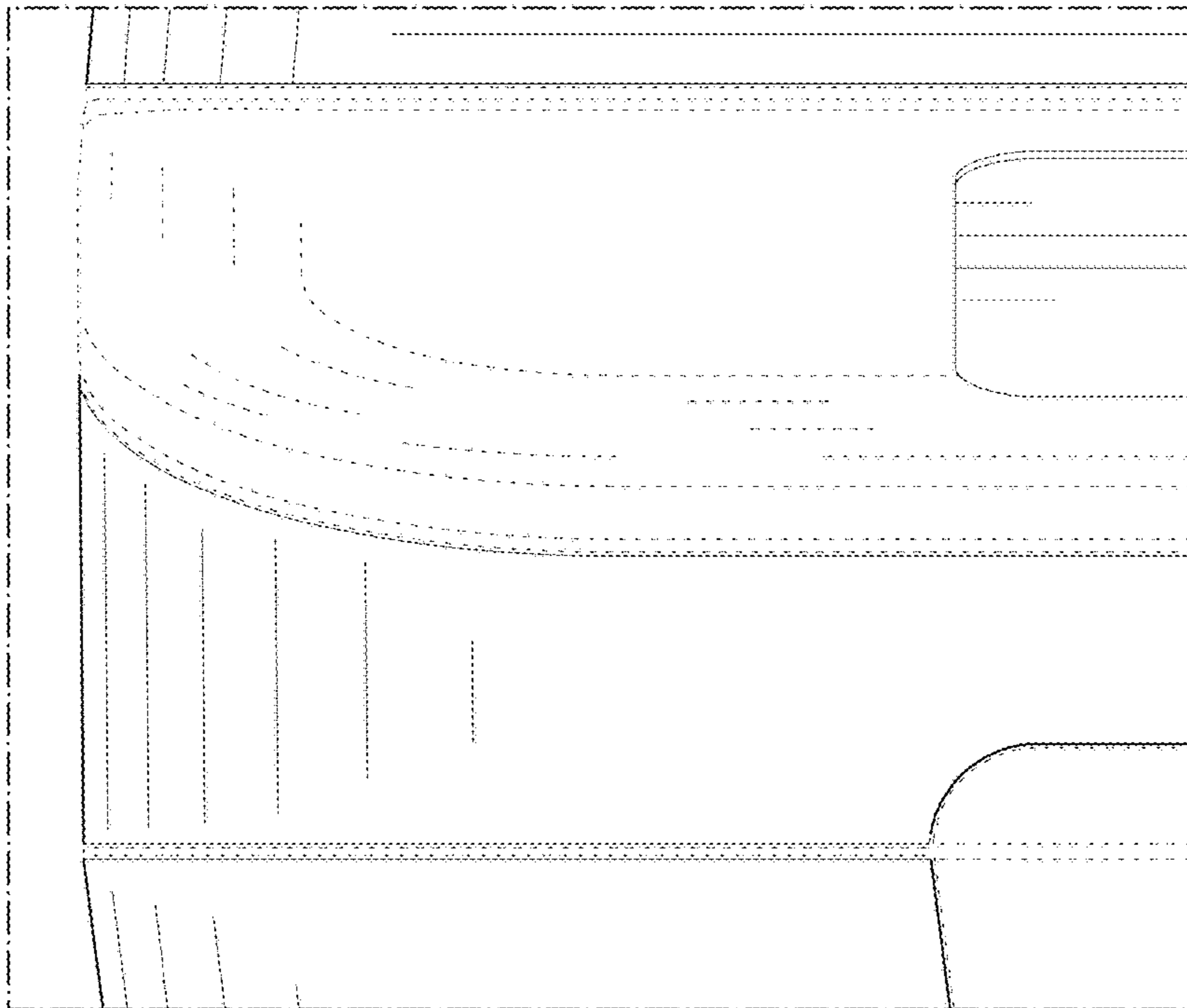

FIG. 8

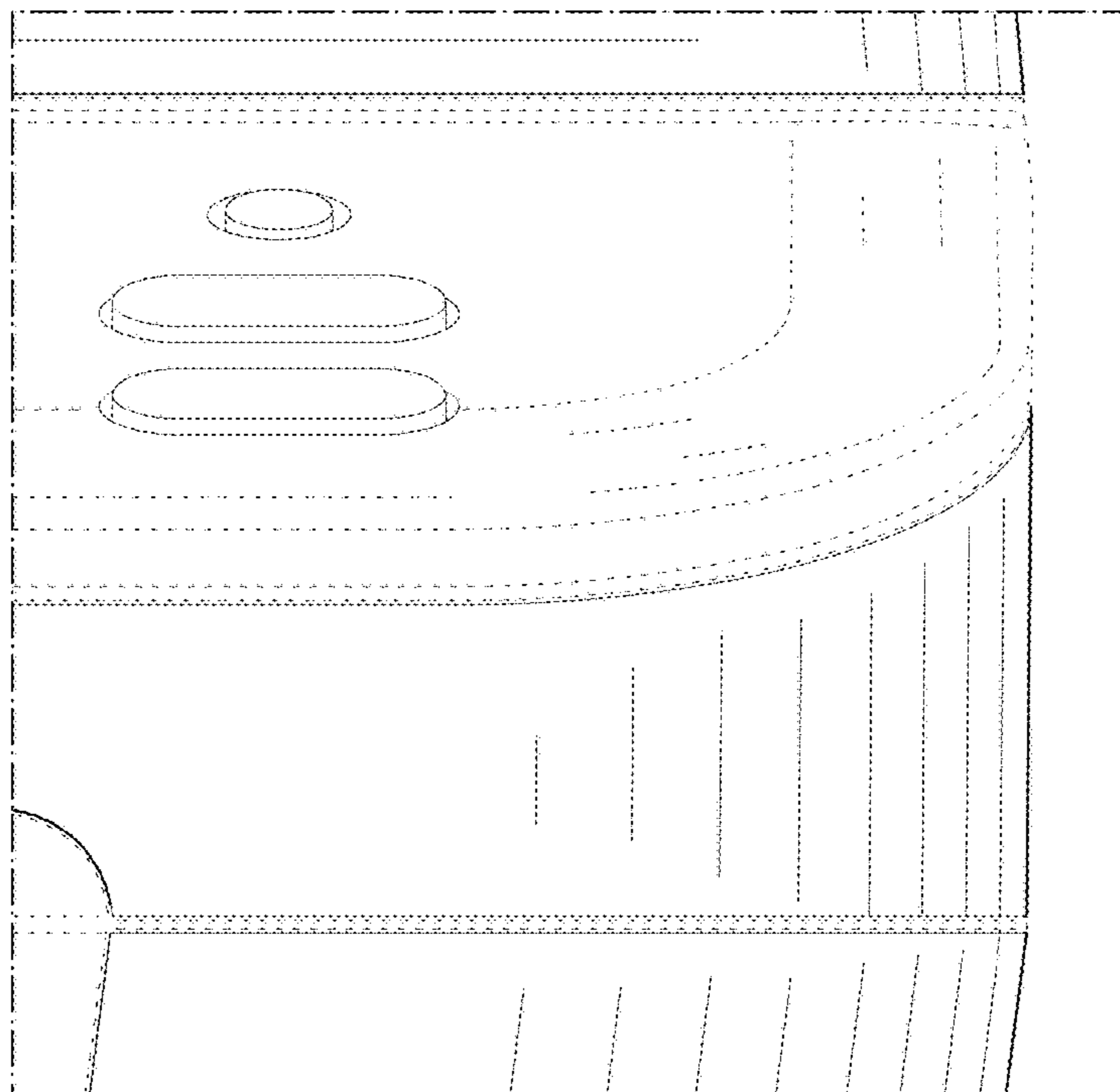

FIG. 9

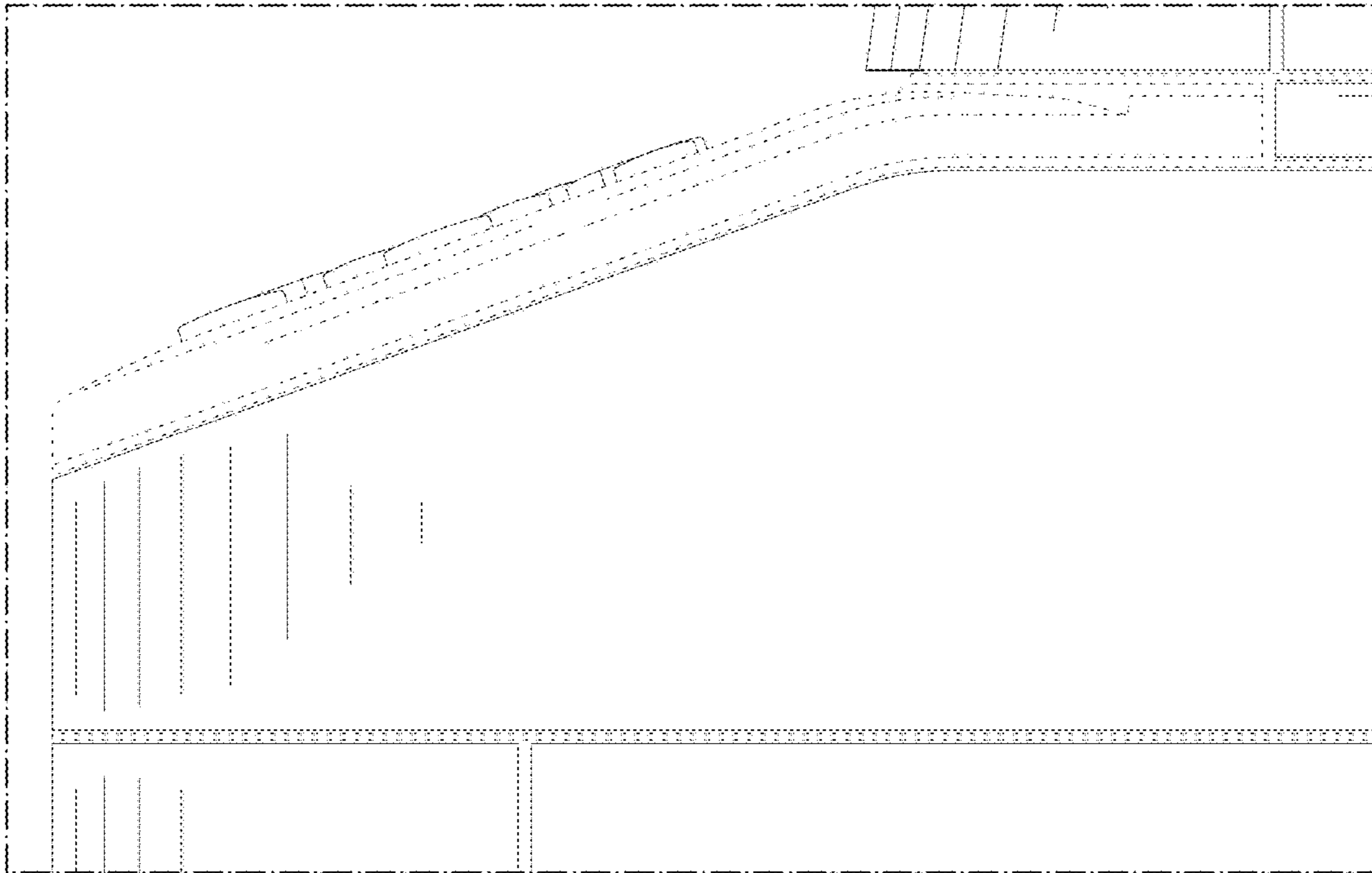

FIG. 10

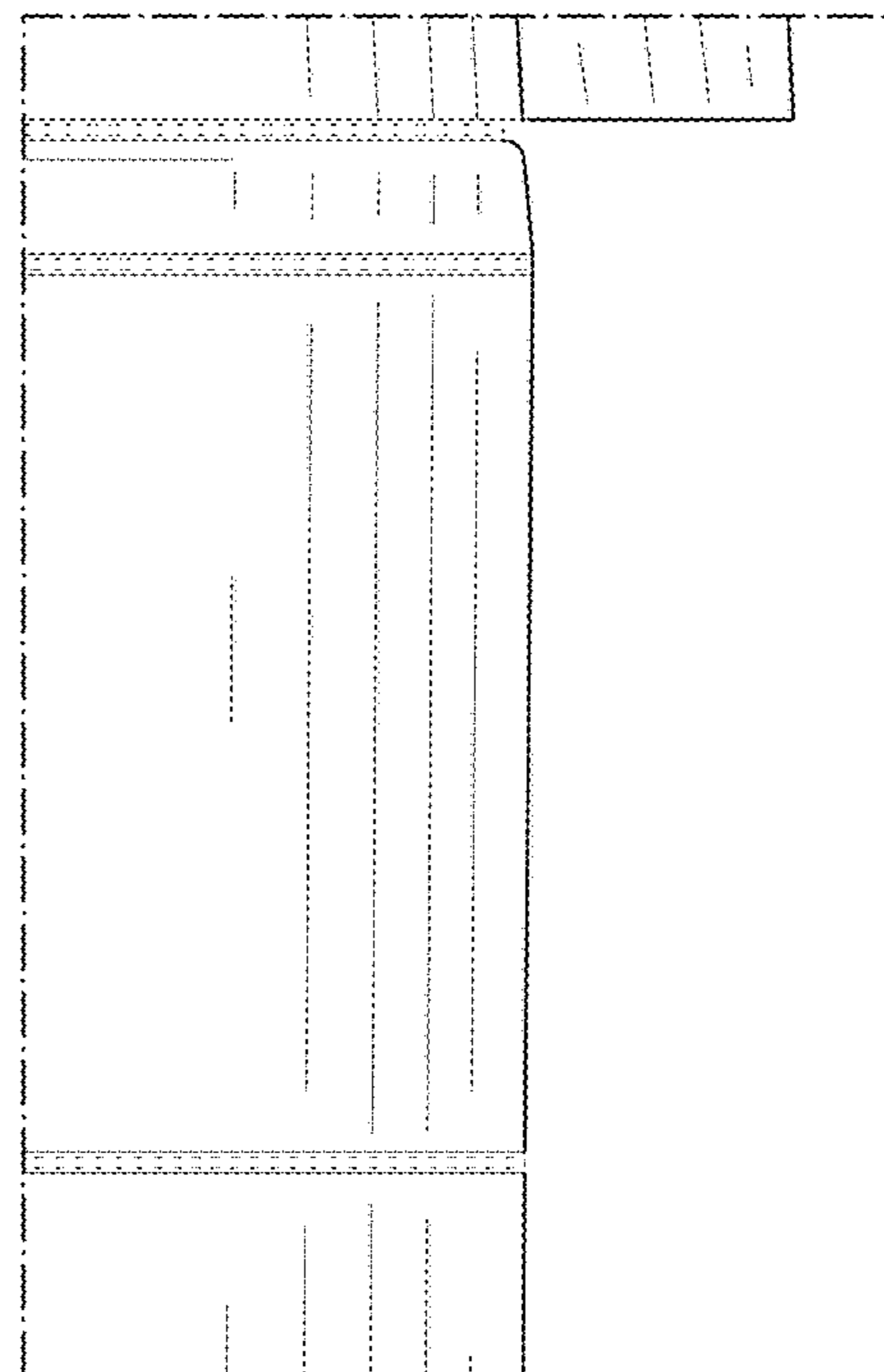

FIG. 11

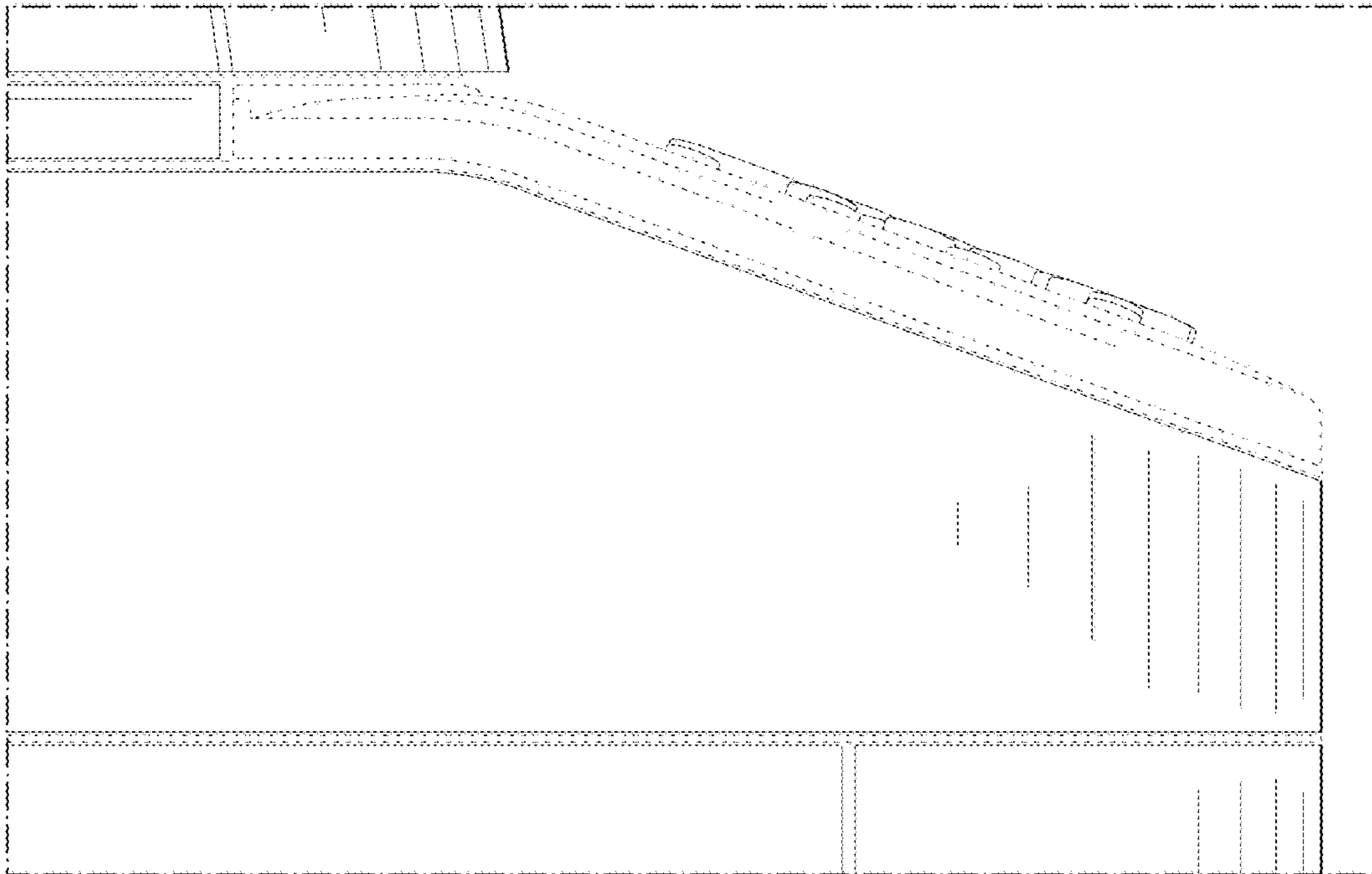

FIG. 12

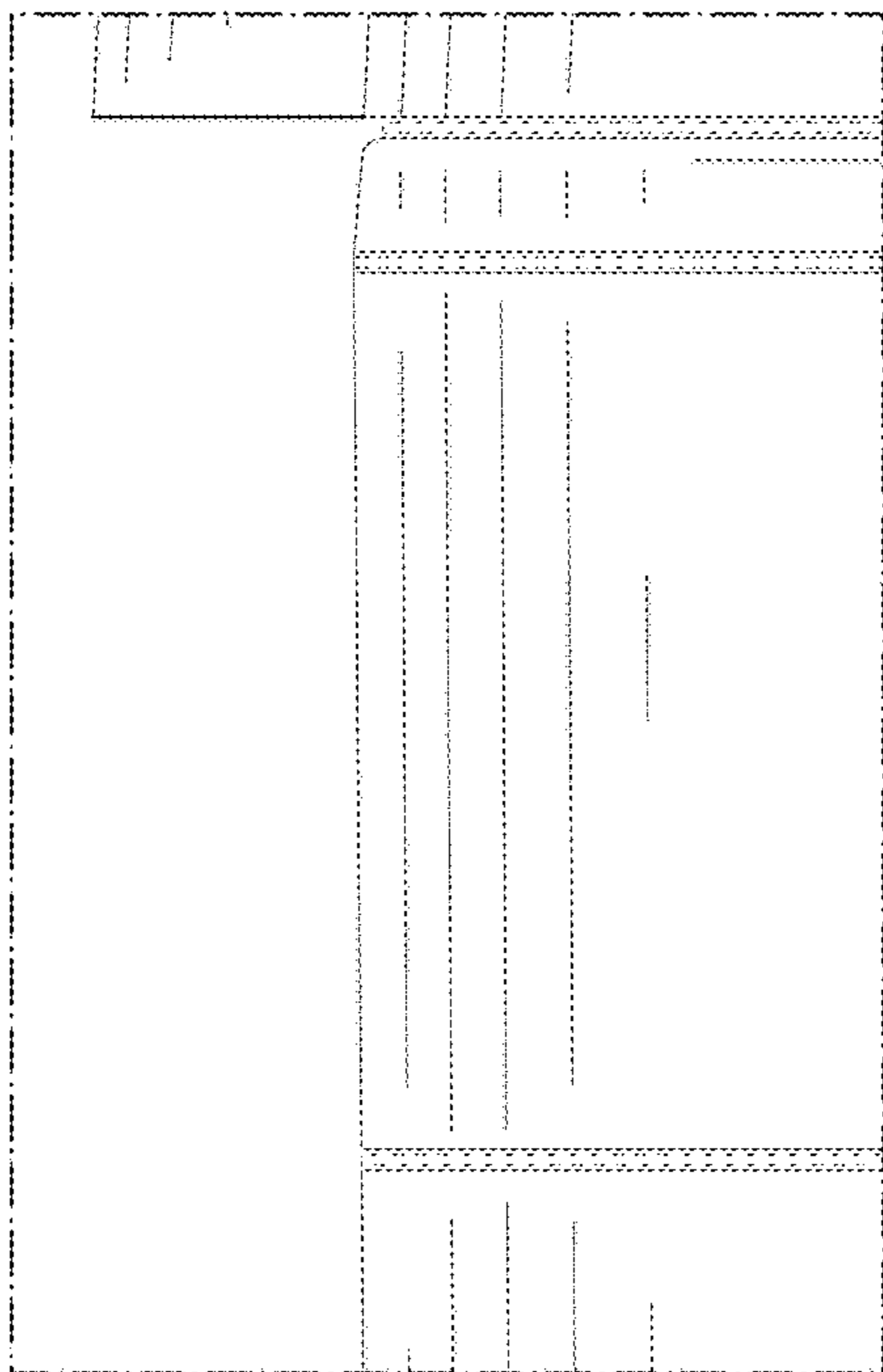

FIG. 13

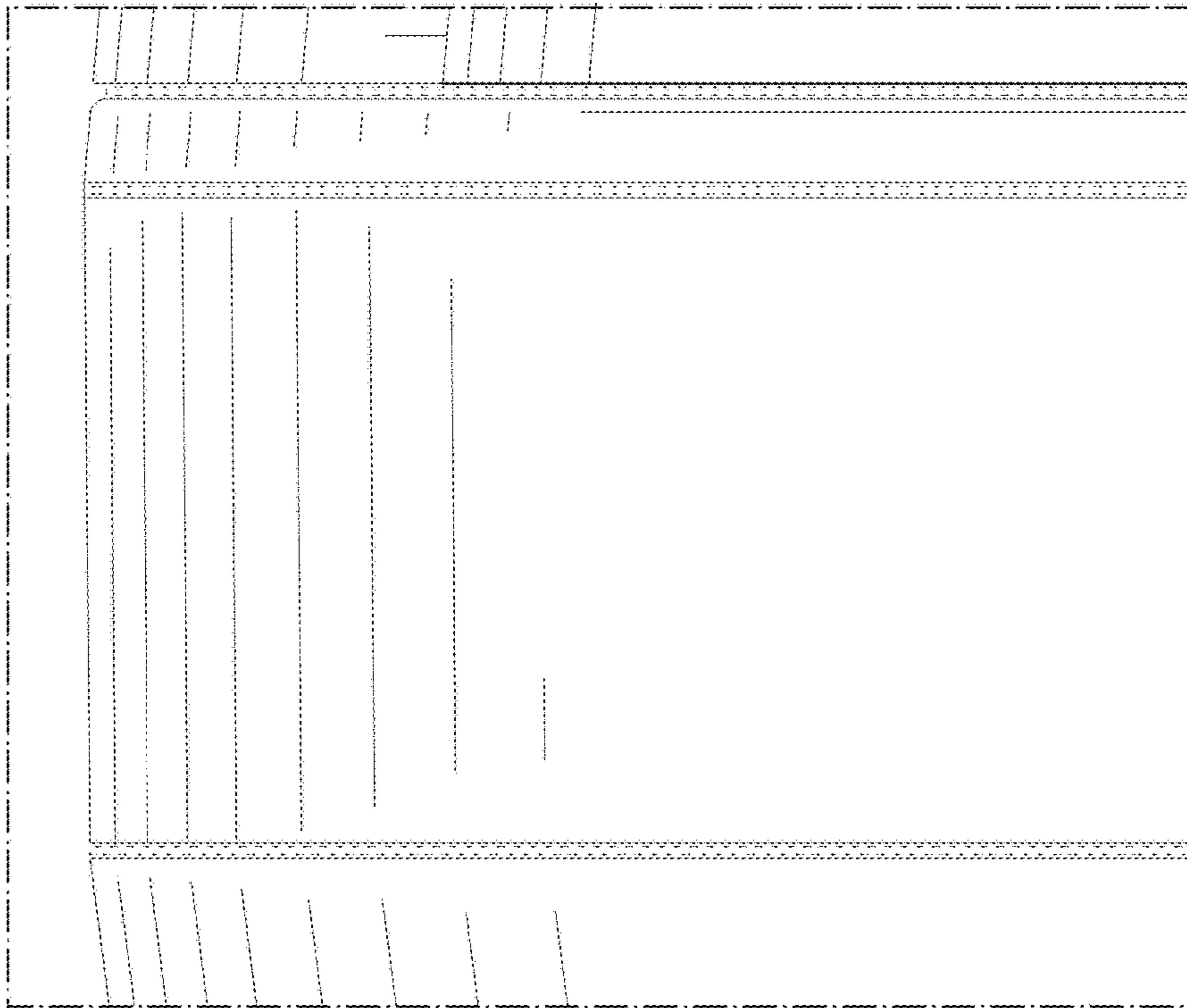

FIG. 14

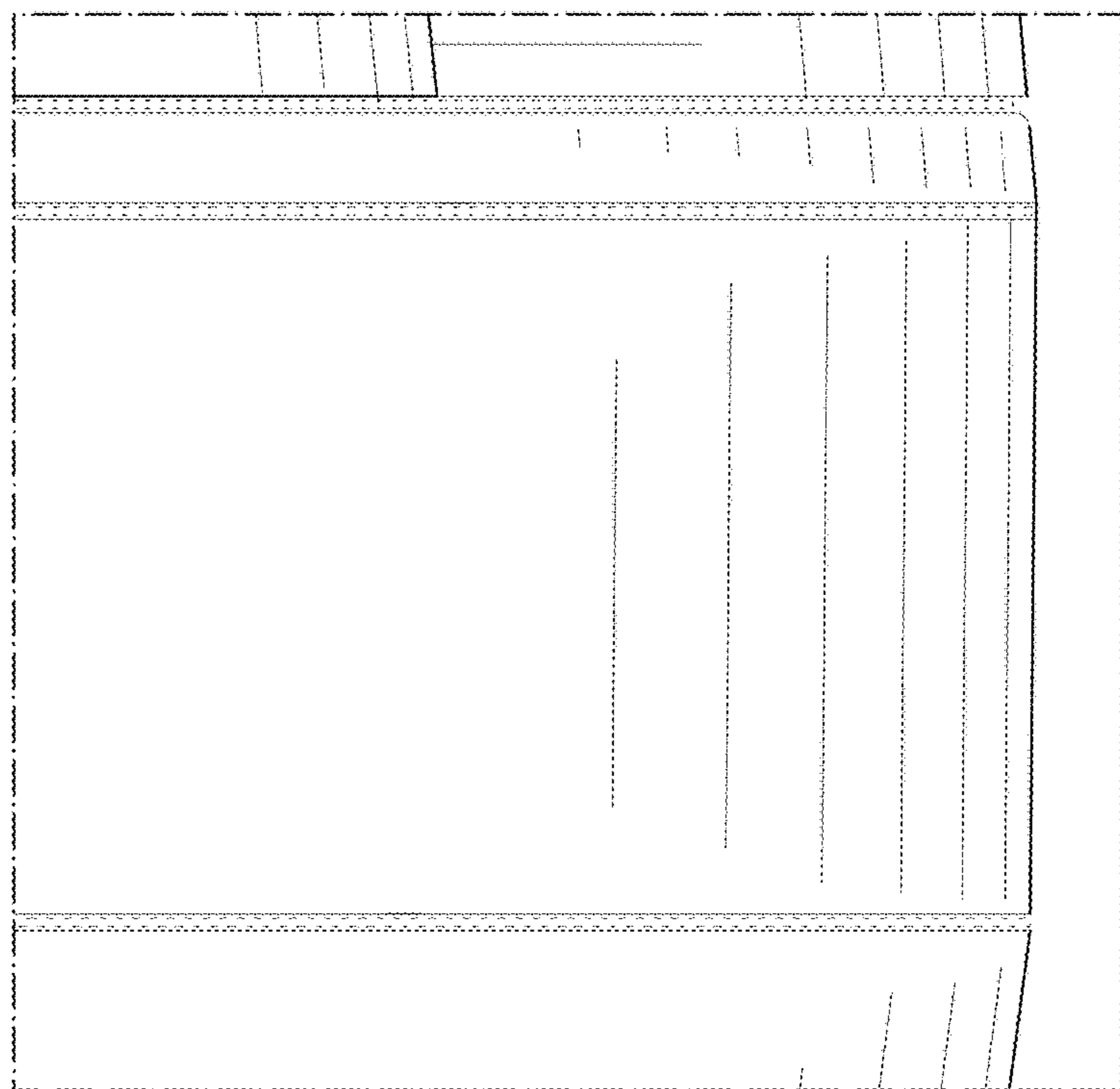

FIG. 15