



US00D800173S

(12) **United States Design Patent**  
**Misao et al.**

(10) **Patent No.:** **US D800,173 S**  
(45) **Date of Patent:** **\*\* Oct. 17, 2017**

(54) **VESSEL PROPULSION UNIT**  
(71) Applicant: **YANMAR CO., LTD.**, Chayamachi,  
Kita-ku, Osaka-shi, Osaka (JP)  
(72) Inventors: **Hideo Misao**, Osaka (JP); **Hisanori**  
**Mori**, Osaka (JP); **David J.**  
**Gruenwald**, Oshkosh, WI (US);  
**George E. Phillips**, Oshkosh, WI (US);  
**Bryan L. Danner**, Oshkosh, WI (US)  
(73) Assignee: **YANMAR CO., LTD.**, Osaka (JP)  
(\*\*) Term: **15 Years**  
(21) Appl. No.: **29/573,702**  
(22) Filed: **Aug. 9, 2016**

5,597,245 A \* 1/1997 Meyerhoff ..... B63H 1/18  
415/221  
5,607,329 A \* 3/1997 Cho ..... B63H 1/16  
310/266  
5,906,522 A \* 5/1999 Hooper ..... B63H 5/14  
416/247 A  
5,975,969 A \* 11/1999 White ..... B63H 5/14  
114/274  
6,152,791 A \* 11/2000 Sinko ..... B63B 1/107  
114/61.12  
6,685,516 B2 \* 2/2004 Tsuboguchi ..... B63H 5/125  
114/144 RE  
D638,855 S \* 5/2011 Daikoku ..... D15/4  
2004/0147181 A1 \* 7/2004 Elizondo ..... B63H 20/00  
440/38  
2009/0124145 A1 \* 5/2009 Acampora ..... B63H 1/14  
440/66  
2010/0167605 A1 \* 7/2010 Schultz ..... B63H 5/14  
440/67  
2010/0248562 A1 \* 9/2010 Daikoku ..... B63H 20/30  
440/3

(30) **Foreign Application Priority Data**

Feb. 19, 2016 (JP) ..... D2016-003668

(51) **LOC (10) Cl.** ..... **15-01**

(52) **U.S. Cl.**  
USPC ..... **D15/4**

(58) **Field of Classification Search**  
USPC ..... D15/4; D12/214, 317  
CPC .. B63H 20/32; B63H 2020/323; B63H 23/30;  
B63H 23/08; B63H 23/22; B63H 5/14;  
B63H 5/15; B63H 21/165; B63H 21/17;  
B63H 21/38; B63H 5/125; B63B 35/68  
See application file for complete search history.

(56) **References Cited**

**U.S. PATENT DOCUMENTS**

3,918,389 A \* 11/1975 Shima ..... B63H 1/16  
114/151  
D277,387 S \* 1/1985 Borgersen ..... D15/149  
5,389,021 A \* 2/1995 Padgett ..... B63H 5/14  
440/67

(Continued)

*Primary Examiner* — T. Chase Nelson

*Assistant Examiner* — Ania Aman

(74) *Attorney, Agent, or Firm* — Andrew F. Young, Esq.;  
Lackebach Siegel, LLP

(57) **CLAIM**

The ornamental design for a vessel propulsion unit, as shown and described.

**DESCRIPTION**

FIG. 1 is a front perspective view of the present invention.  
FIG. 2 is another perspective view thereof.  
FIG. 3 is a front view thereof.  
FIG. 4 is a rear view thereof.  
FIG. 5 is a top plan view thereof.  
FIG. 6 is a bottom plan view thereof.  
FIG. 7 is a left side view thereof; and,  
FIG. 8 is a right side view thereof.

**1 Claim, 8 Drawing Sheets**

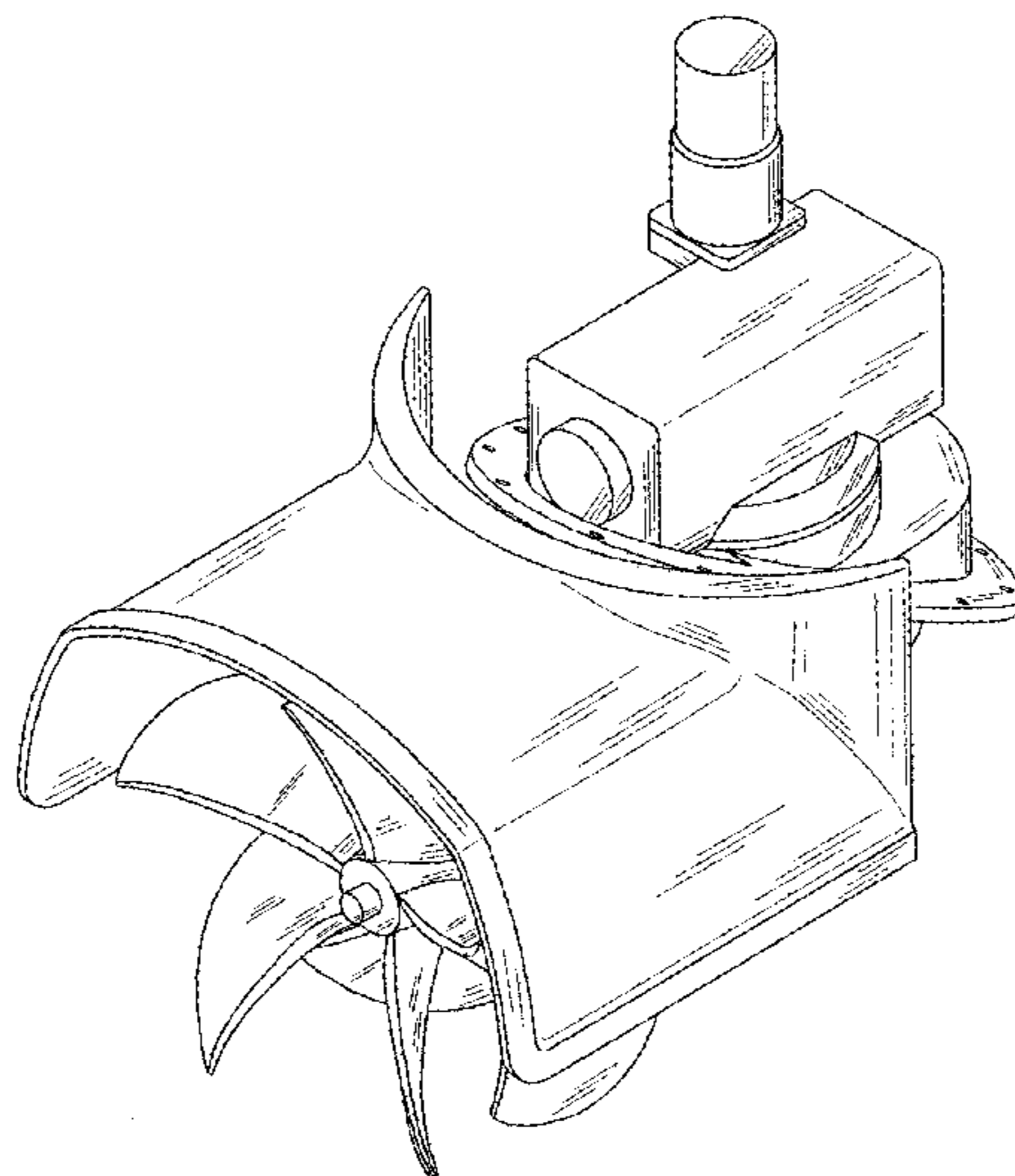

(56)

**References Cited**

U.S. PATENT DOCUMENTS

2012/0304625 A1\* 12/2012 Daikoku ..... F01N 3/046  
60/276  
2012/0308382 A1\* 12/2012 Lehmann ..... B63H 25/34  
415/221  
2015/0203182 A1\* 7/2015 Aasebo ..... B63H 23/22  
416/23  
2015/0210370 A1\* 7/2015 Johannessen ..... B63H 1/16  
416/1  
2015/0360760 A1\* 12/2015 Song ..... B63H 5/15  
416/189  
2015/0367921 A1\* 12/2015 Aasebo ..... B63H 5/15  
415/119  
2015/0381224 A1\* 12/2015 Edwards ..... G01M 15/00  
415/122.1

\* cited by examiner

FIG. 1

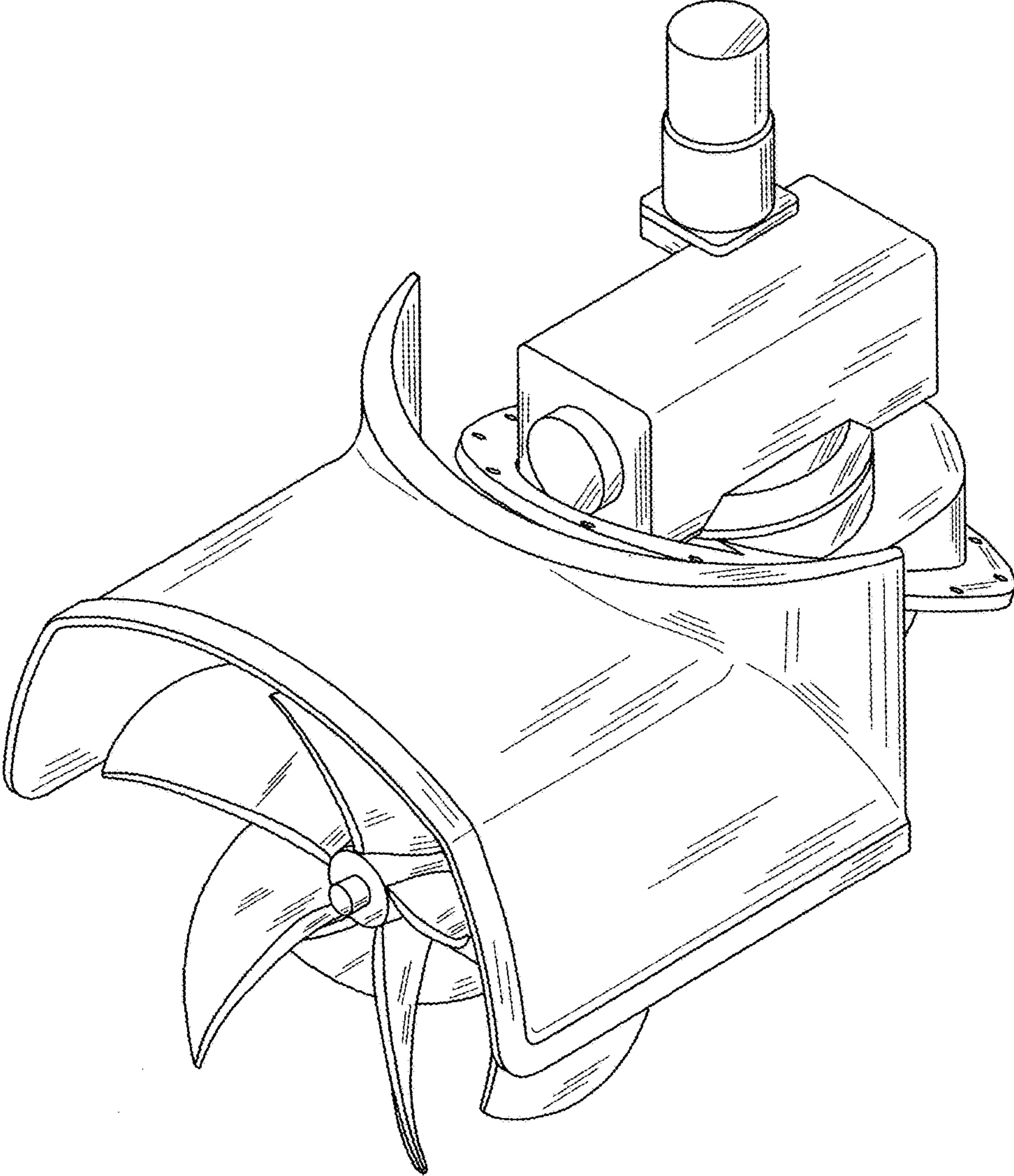

FIG. 2

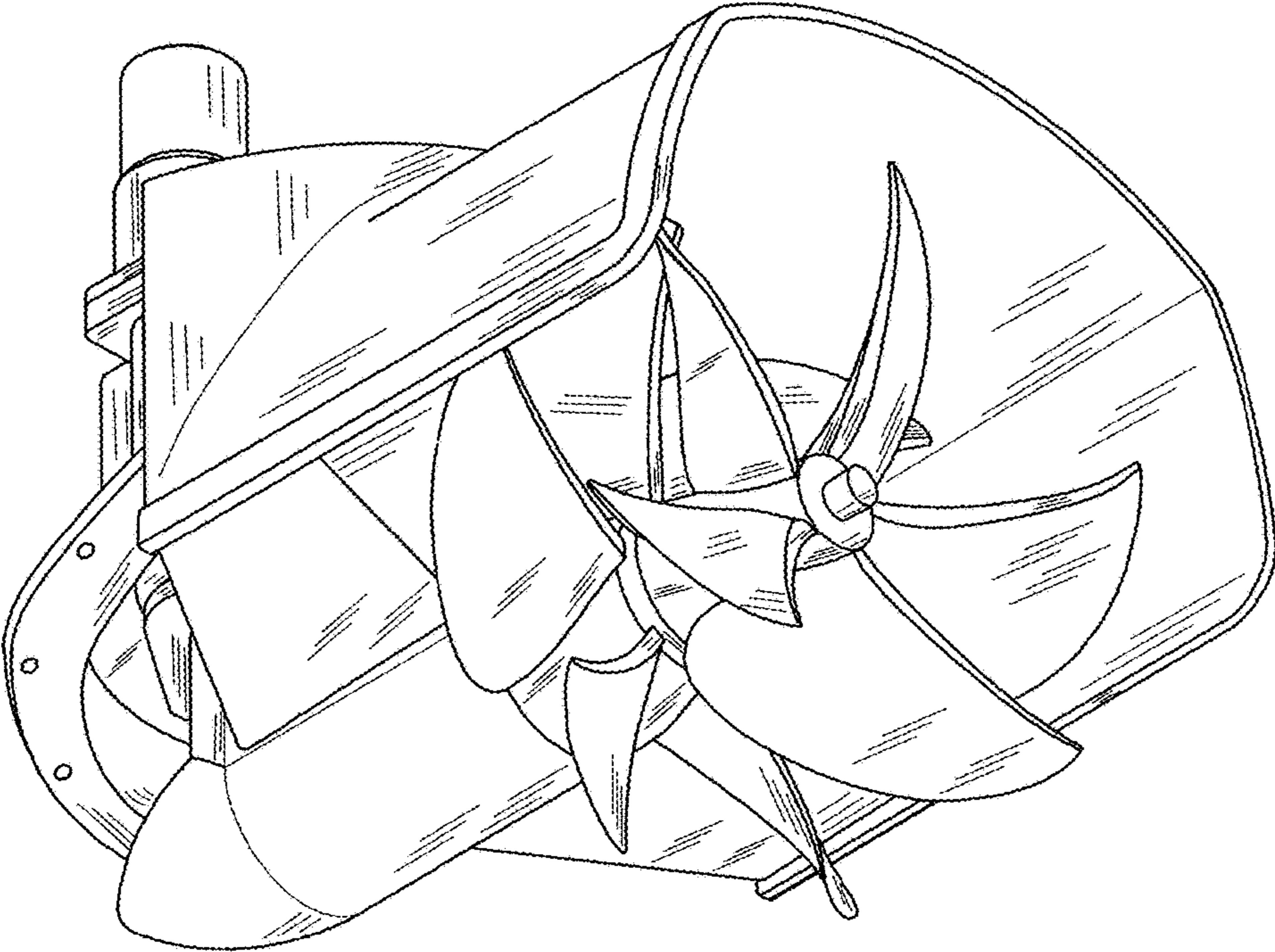

FIG. 3

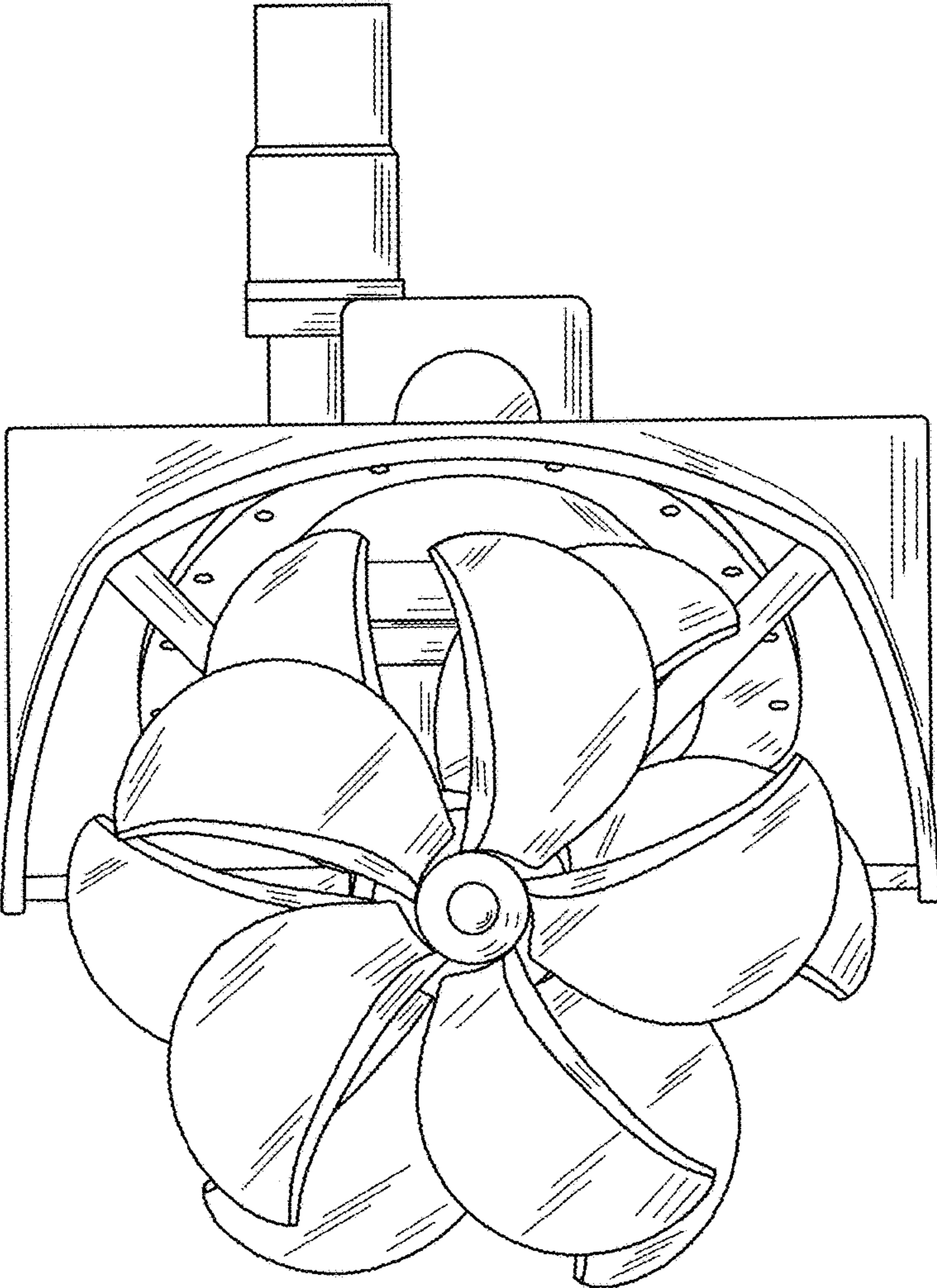

FIG. 4

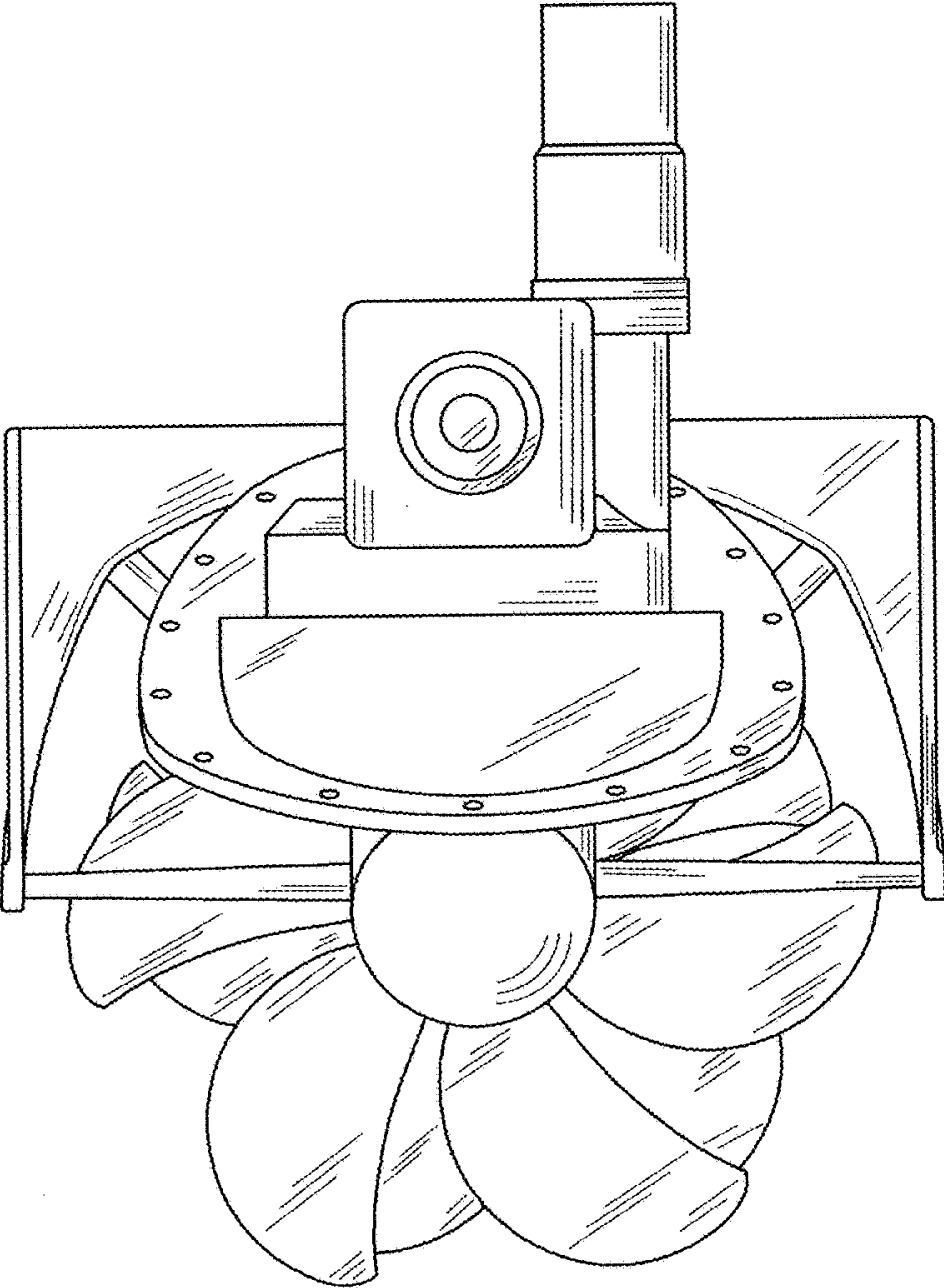

FIG. 5

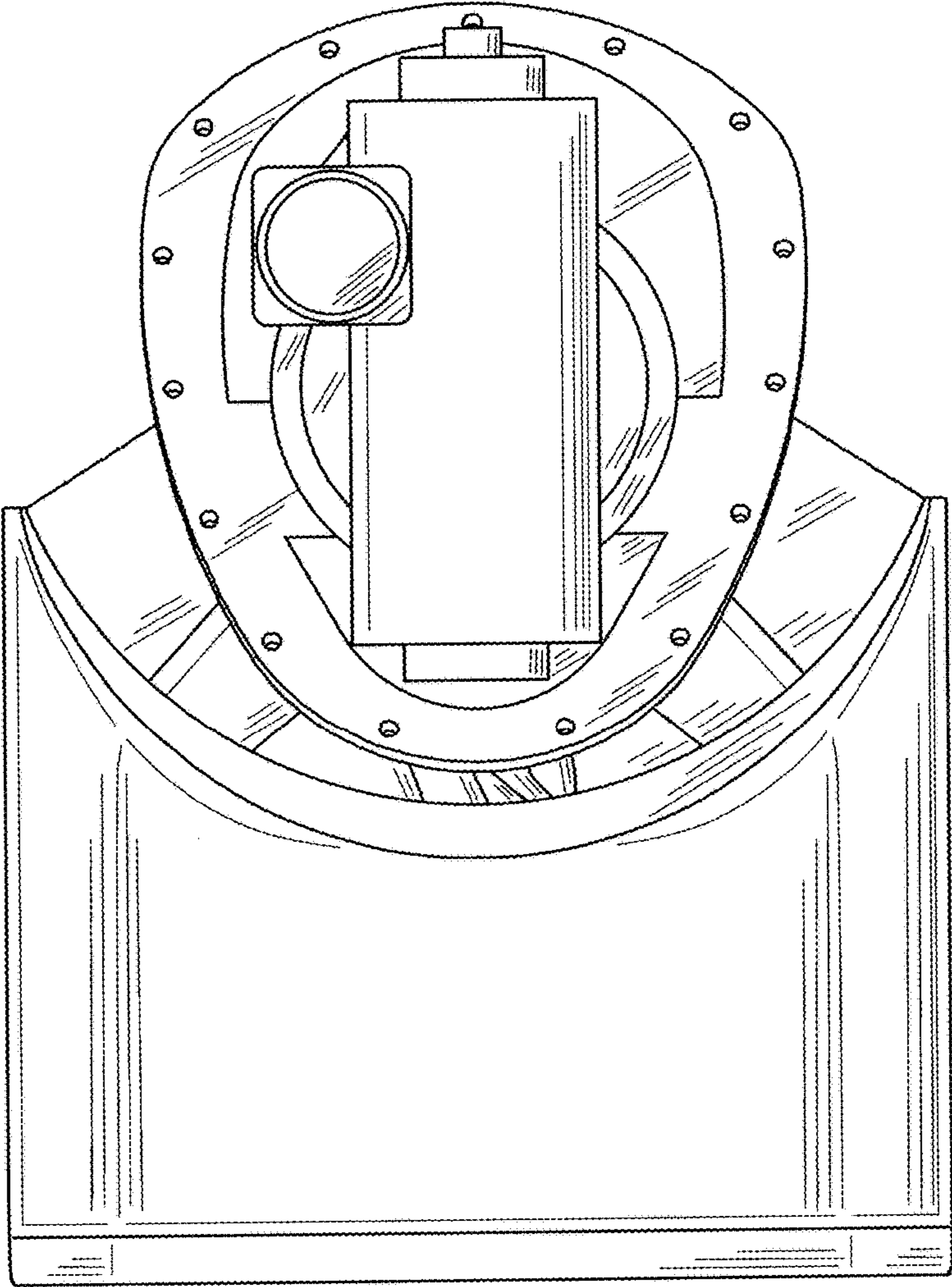

FIG. 6

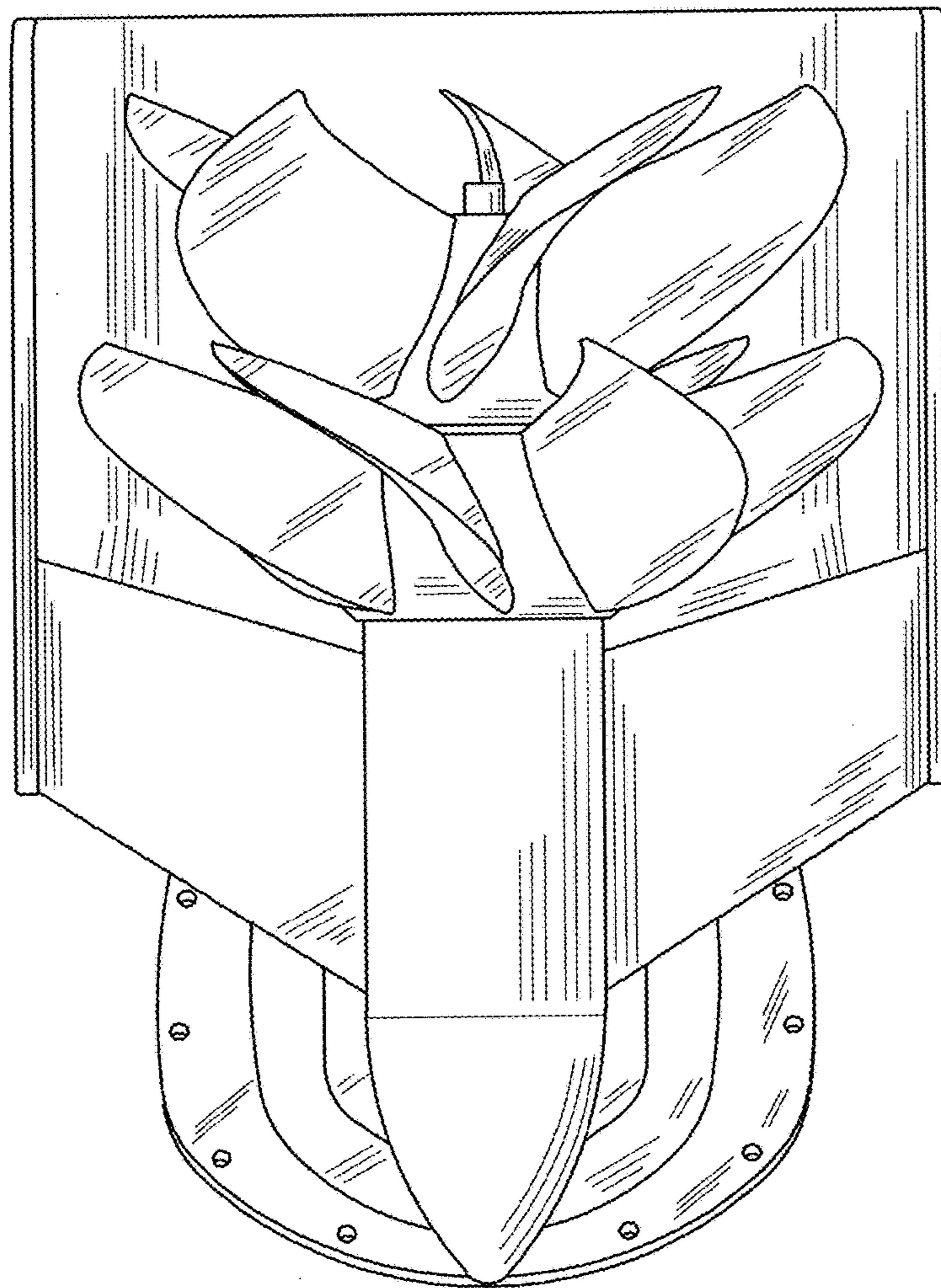



FIG. 7

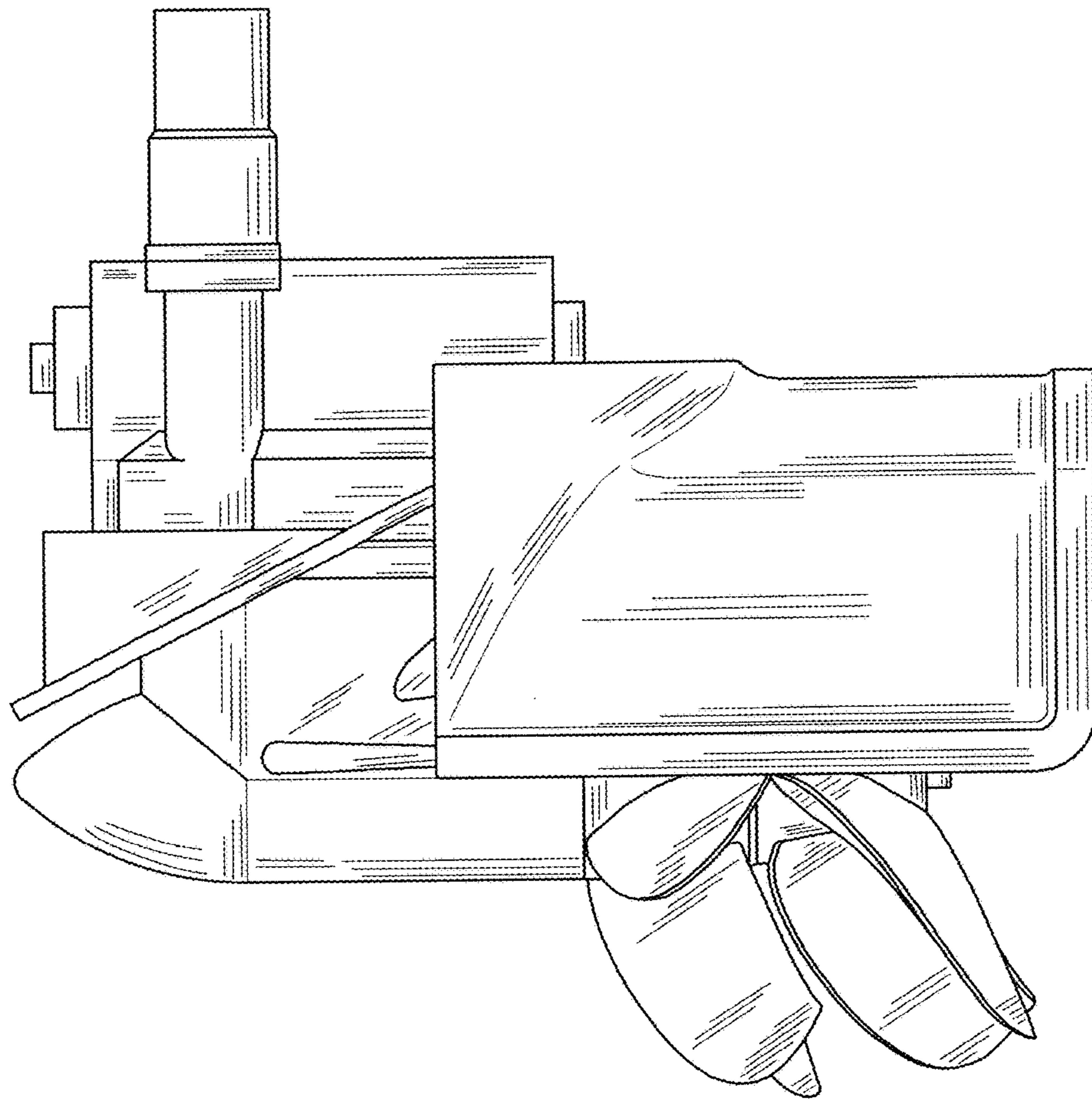

FIG. 8

