



US00D800163S

(12) **United States Design Patent**
Tsukahara

(10) **Patent No.:** **US D800,163 S**
(45) **Date of Patent:** **** Oct. 17, 2017**

(54) **DISPLAY SCREEN WITH ANIMATED GRAPHICAL USER INTERFACE**

(71) Applicant: **Microsoft Corporation**, Redmond, WA (US)

(72) Inventor: **Hiroshi Tsukahara**, Bellevue, WA (US)

(73) Assignee: **Microsoft Corporation**, Redmond, WA (US)

(**) Term: **15 Years**

(21) Appl. No.: **29/562,714**

(22) Filed: **Apr. 28, 2016**

(51) **LOC (10) Cl.** **14-04**

(52) **U.S. Cl.**
USPC **D14/492**; D14/488

(58) **Field of Classification Search**
USPC D14/485-495
(Continued)

(56) **References Cited**

U.S. PATENT DOCUMENTS

D390,548 S * 2/1998 Maekawa D14/488
D532,017 S * 11/2006 Gusmorino D14/492
(Continued)

OTHER PUBLICATIONS

Dreamstime | Stock Vector: Smartwatch and Application Icons, posted on Jun. 27, 2016, © 2000-2017 Dreamstime [online], [site visited May 23, 2017]. Available from Internet, <URL: <https://www.dreamstime.com/stock-illustration-smartwatch-application-icons-smart-watch-colorful-sharing-image59870805/>>.*

(Continued)

Primary Examiner — Philip S Hyder

Assistant Examiner — Cary M Robinson

(74) *Attorney, Agent, or Firm* — Banner & Witcoff, Ltd.

(57) **CLAIM**

The ornamental design for a display screen with animated graphical user interface, as shown and described.

DESCRIPTION

FIG. 1 is the first image in a sequence for a display screen with animated graphical user interface showing my new design;

FIG. 2 is the second image thereof;

FIG. 3 is the third image thereof;

FIG. 4 is the fourth image thereof;

FIG. 5 is the fifth image thereof;

FIG. 6 is the sixth image thereof;

FIG. 7 is the seventh image thereof;

FIG. 8 is the first image in a sequence for a display screen with animated graphical user interface showing an alternative embodiment of my new design;

FIG. 9 is the second image thereof;

FIG. 10 is the third image thereof;

FIG. 11 is the fourth image thereof;

FIG. 12 is the fifth image thereof;

FIG. 13 is the sixth image thereof;

FIG. 14 is the seventh image thereof;

FIG. 15 is the first image in a sequence for a display screen with animated graphical user interface showing another alternative embodiment of my new design;

FIG. 16 is the second image thereof;

FIG. 17 is the third image thereof;

FIG. 18 is the fourth image thereof;

FIG. 19 is the fifth image thereof;

FIG. 20 is the sixth image thereof; and,

FIG. 21 is the seventh image thereof.

The appearance of the animated graphical user interface sequentially transitions between the images shown in FIGS. 1-7, 8-14, and 15-21.

The outermost broken line illustrates the display screen, and the remainder of the broken lines, including the broken line showing of alphanumeric characters and envelope, illustrate portions of the animated graphical user interface. None of the broken lines form part of the claimed design.

1 Claim, 21 Drawing Sheets

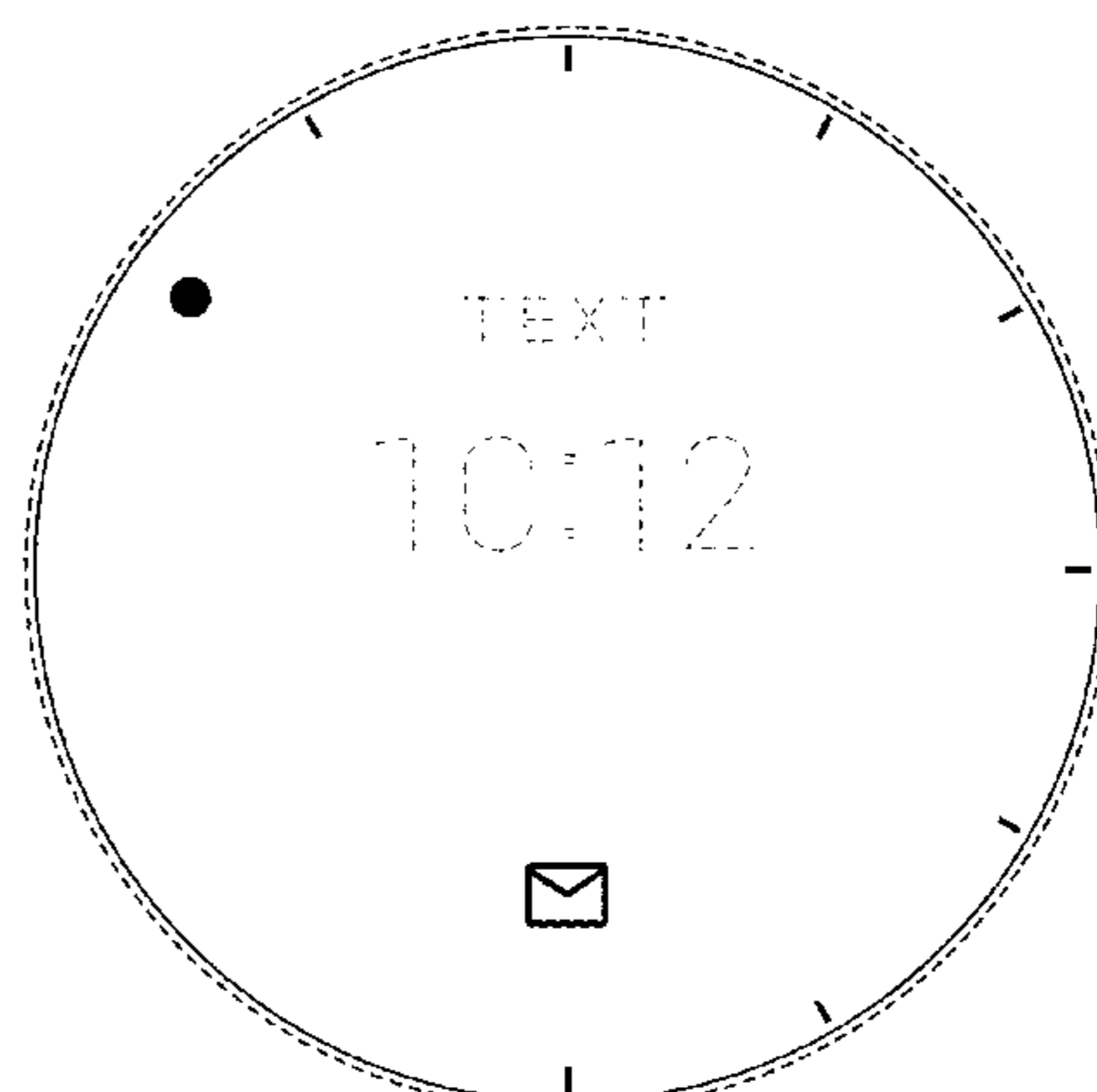

(58) **Field of Classification Search**

CPC B61C 11/04; B64C 29/00; G06F 3/04817;
G06F 3/0482; G06F 2203/04807; G06T
15/02; G06T 13/80; H04M 1/2477; H04N
1/00424

See application file for complete search history.

(56)

References Cited

U.S. PATENT DOCUMENTS

D656,954	S	*	4/2012	Arnold	D14/489
D682,850	S	*	5/2013	Del Pasqua	D14/485
D690,316	S	*	9/2013	Meng	D14/486
D743,432	S	*	11/2015	Sergeev	D14/487
D753,678	S	*	4/2016	Clarke	D14/485
D753,696	S	*	4/2016	Dye	D14/486
D753,711	S	*	4/2016	Dye	D14/488
D764,549	S	*	8/2016	Cavander	G06F 3/04817 D14/494
D771,063	S	*	11/2016	Yang	D14/485
D782,528	S	*	3/2017	Dzjind	D14/488
D782,530	S	*	3/2017	Paek	D14/488
D785,017	S	*	4/2017	Wang	D14/486
D785,658	S	*	5/2017	Moroney	D14/486
2009/0154296	A1	*	6/2009	Behling	G04B 19/247 368/10

2012/0066629	A1	*	3/2012	Lee	G06F 3/04847 715/769
2012/0071208	A1	*	3/2012	Lee	H04M 1/72544 455/566
2012/0192095	A1	*	7/2012	Bamford	G06F 3/0488 715/779

OTHER PUBLICATIONS

Facerepo | Faces by RuffRider, posted on May 6, 2016, no copyright date posted [online], [site visited May 23, 2017]. Available from Internet, <URL: <https://facerepo.com/app/faces/facer-author/pmdQ7dWSQZ/1/>>.*

Golem.De | Microsoft Outlook Watch Face for Android Smartwatches, posted on Apr. 6, 2016, © 1997-2017 Golem.de [online], [site visited May 23, 2017]. Available from Internet, <URL: <https://www.golem.de/news/microsoft-outlook-watch-face-fuer-android-smartwatches-1606-121300.html/>>.*

Google Play | Store | Apps | Heart Rate—Sport Gear + Wear, updated on Mar. 21, 2016, © 2017 Google [online], [site visited May 23, 2017]. Available from Internet, <URL: https://play.google.com/store/apps/details?id=com.pnn.android.sport_gear_tracker>.*

Thurrott | Microsoft Launches Outlook Watch Face for Android Wear, posted on Jun. 3, 2016, © 2017 BWW Media Group [online], [site visited May 23, 2017]. Available from Internet, <URL: <https://www.thurrott.com/mobile/android/67682/microsoft-launches-outlook-watch-face-android-wear/>>.*

* cited by examiner



FIG. 1

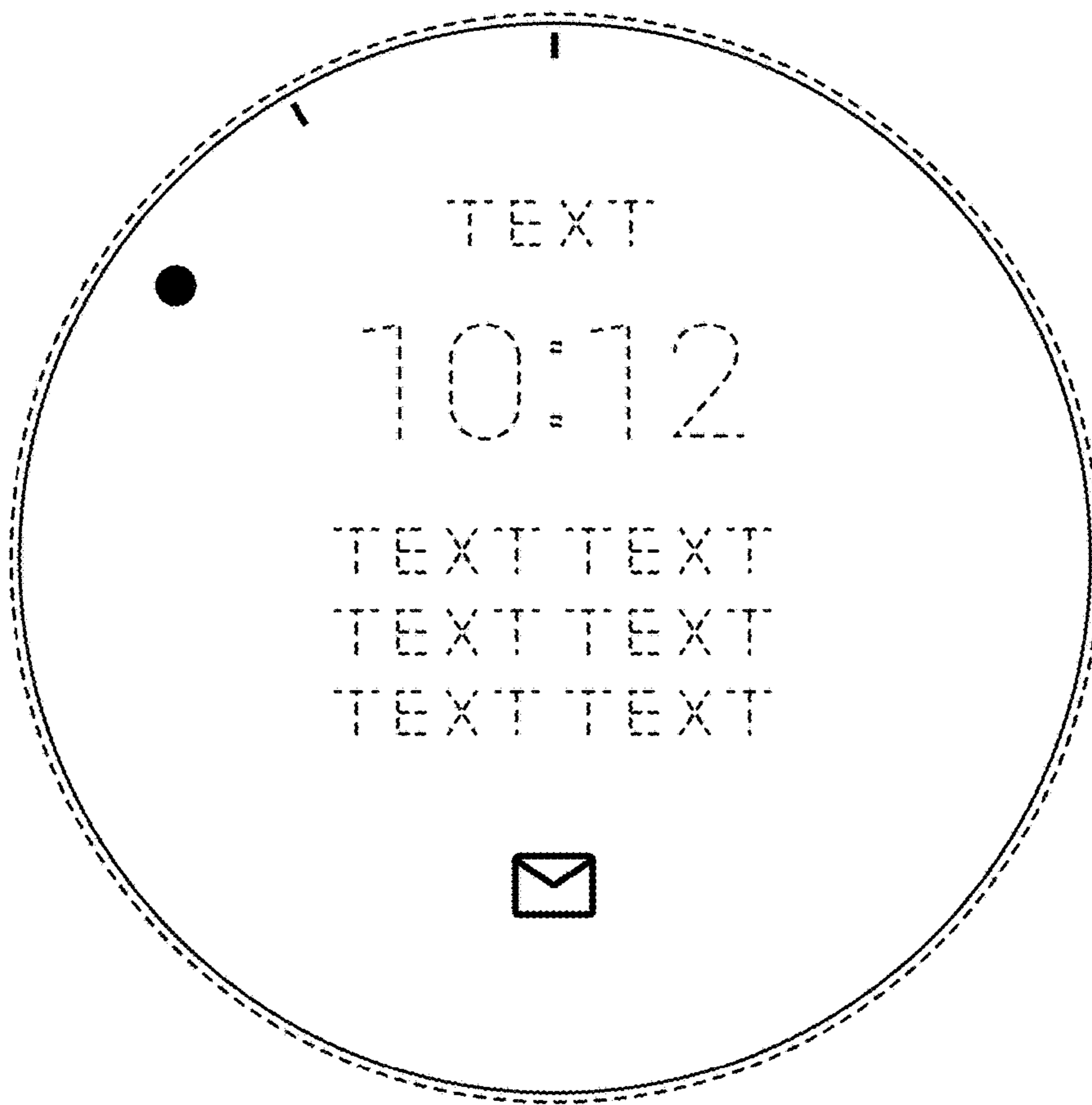

FIG. 2

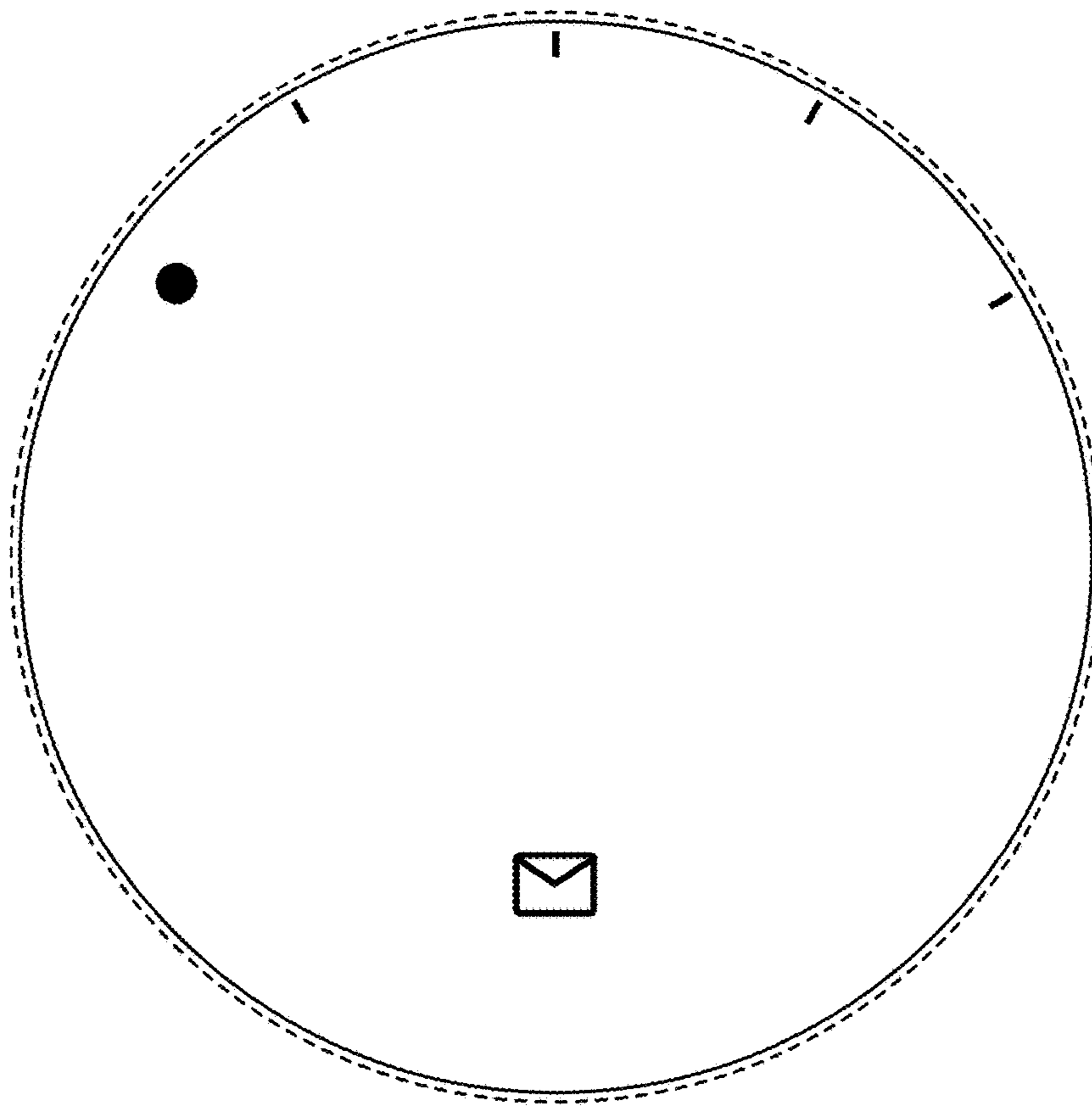

FIG. 3

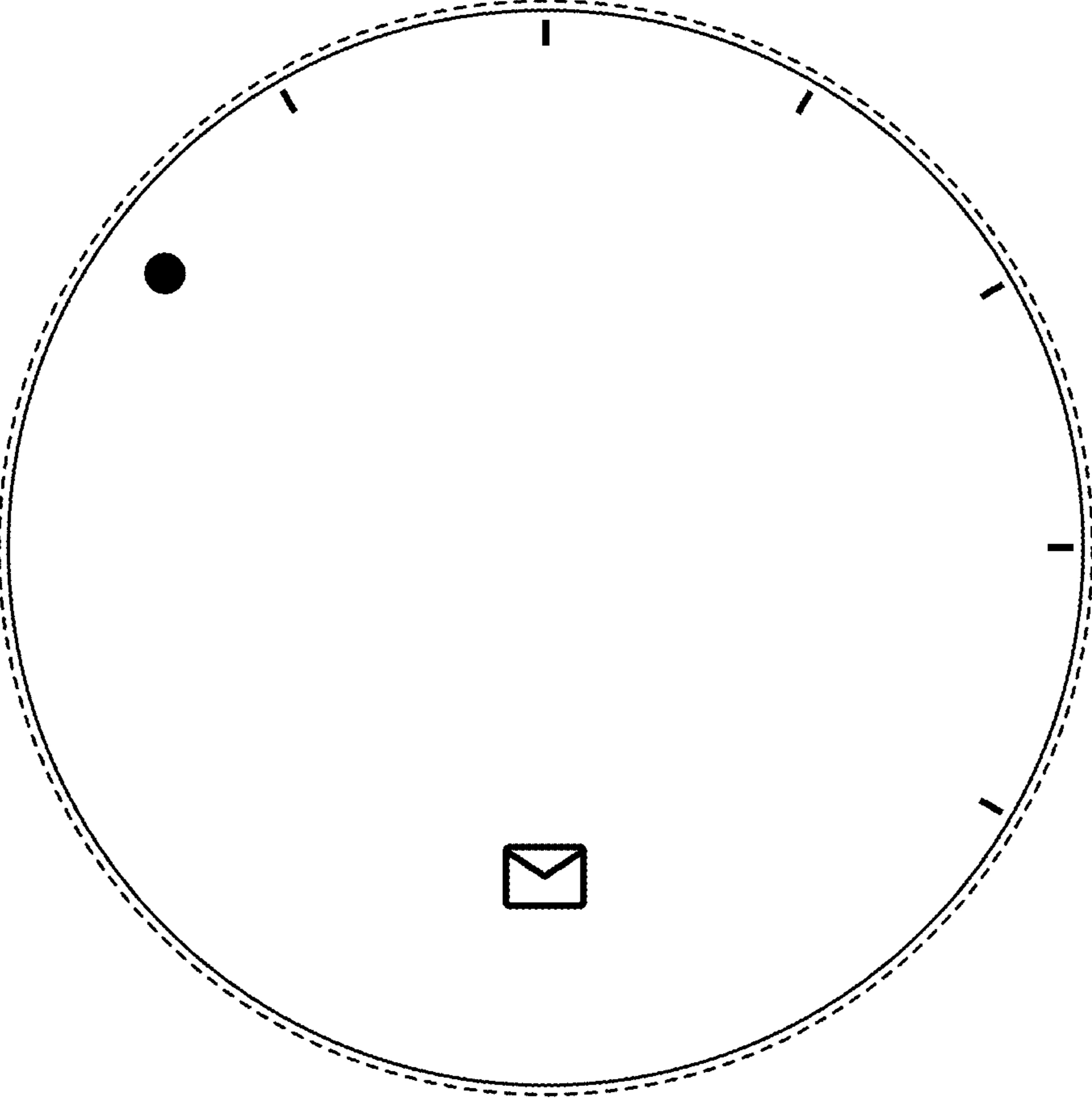

FIG. 4

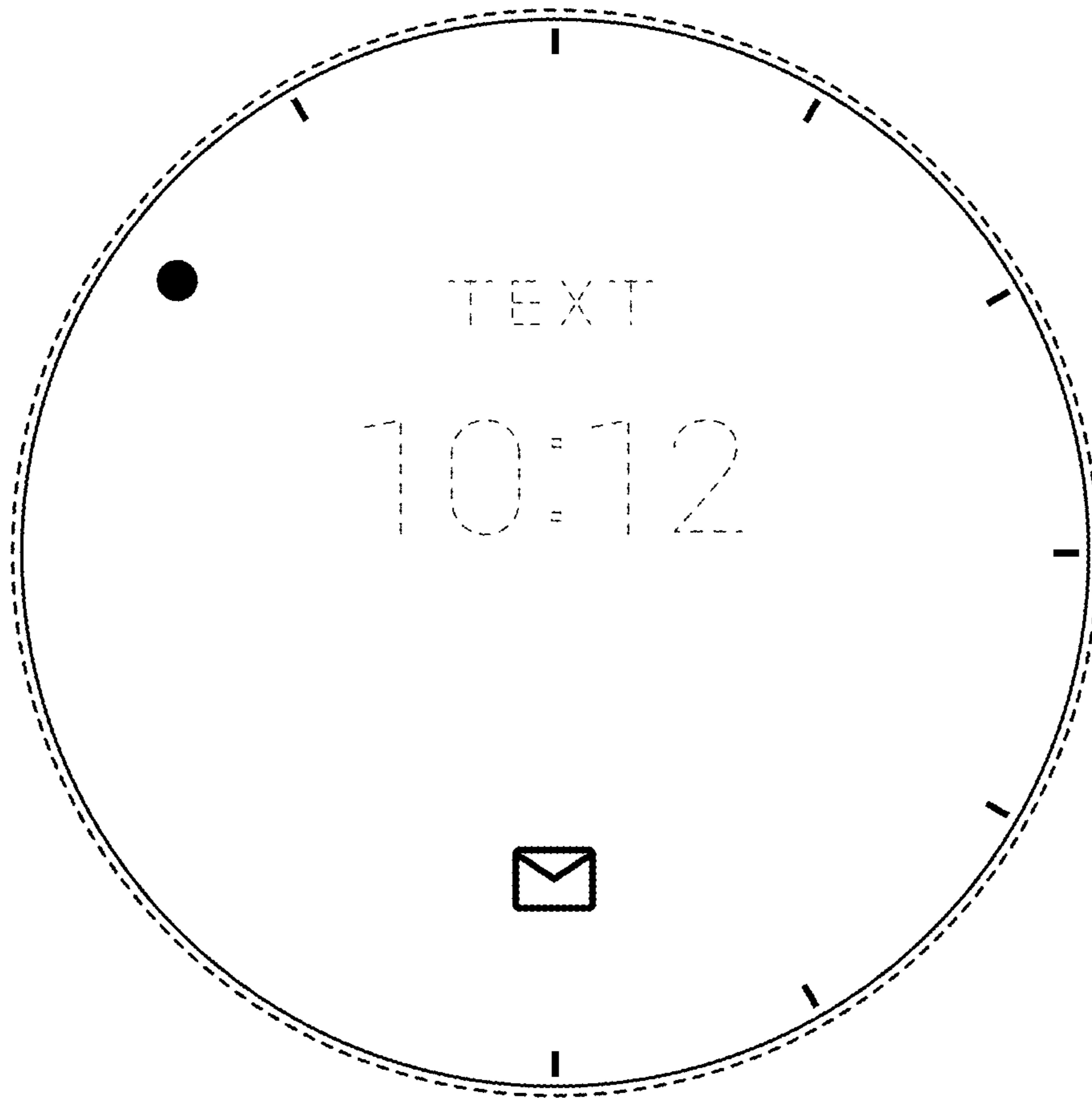

FIG. 5

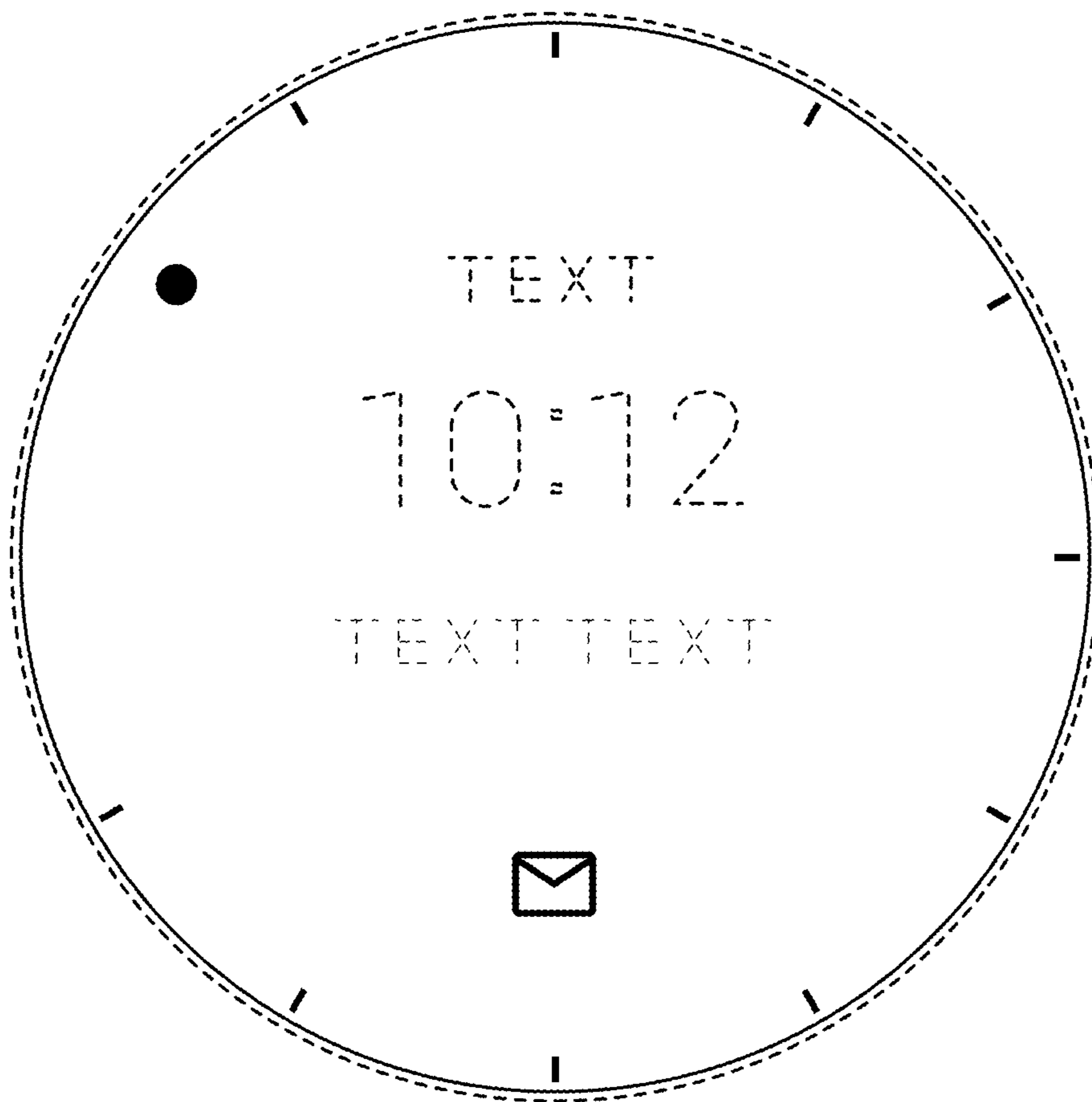

FIG. 6

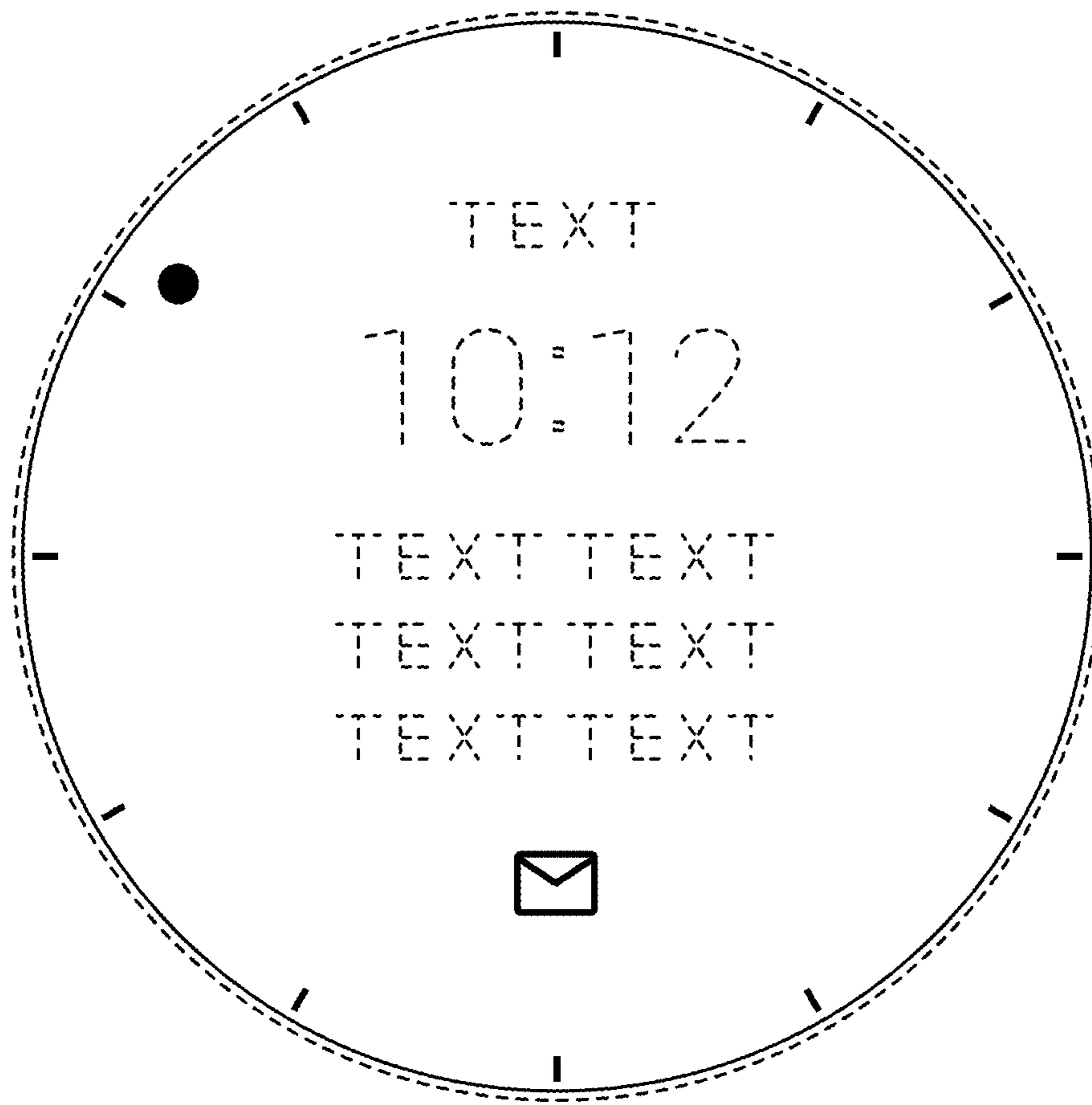

FIG. 7

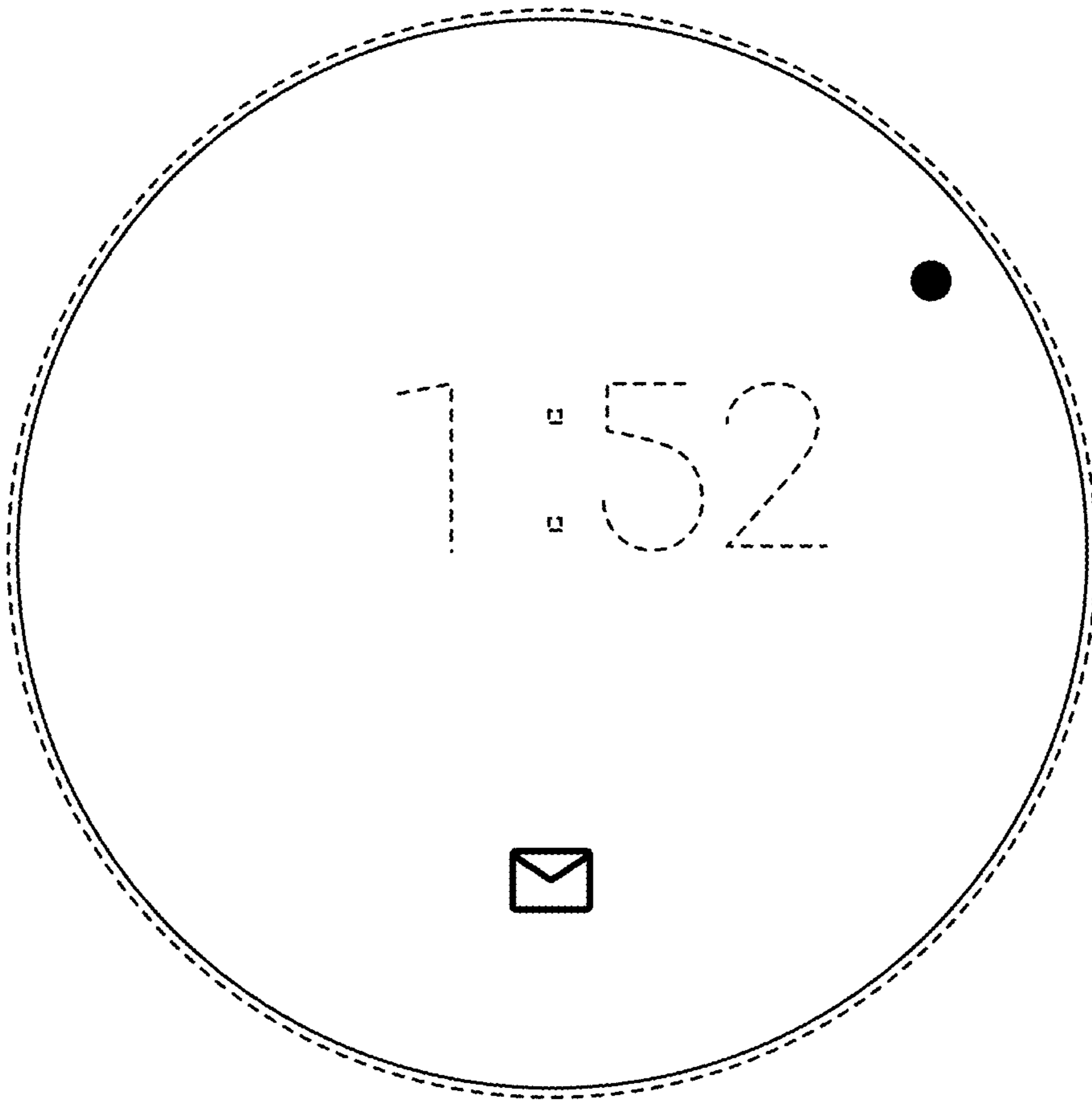

FIG. 8

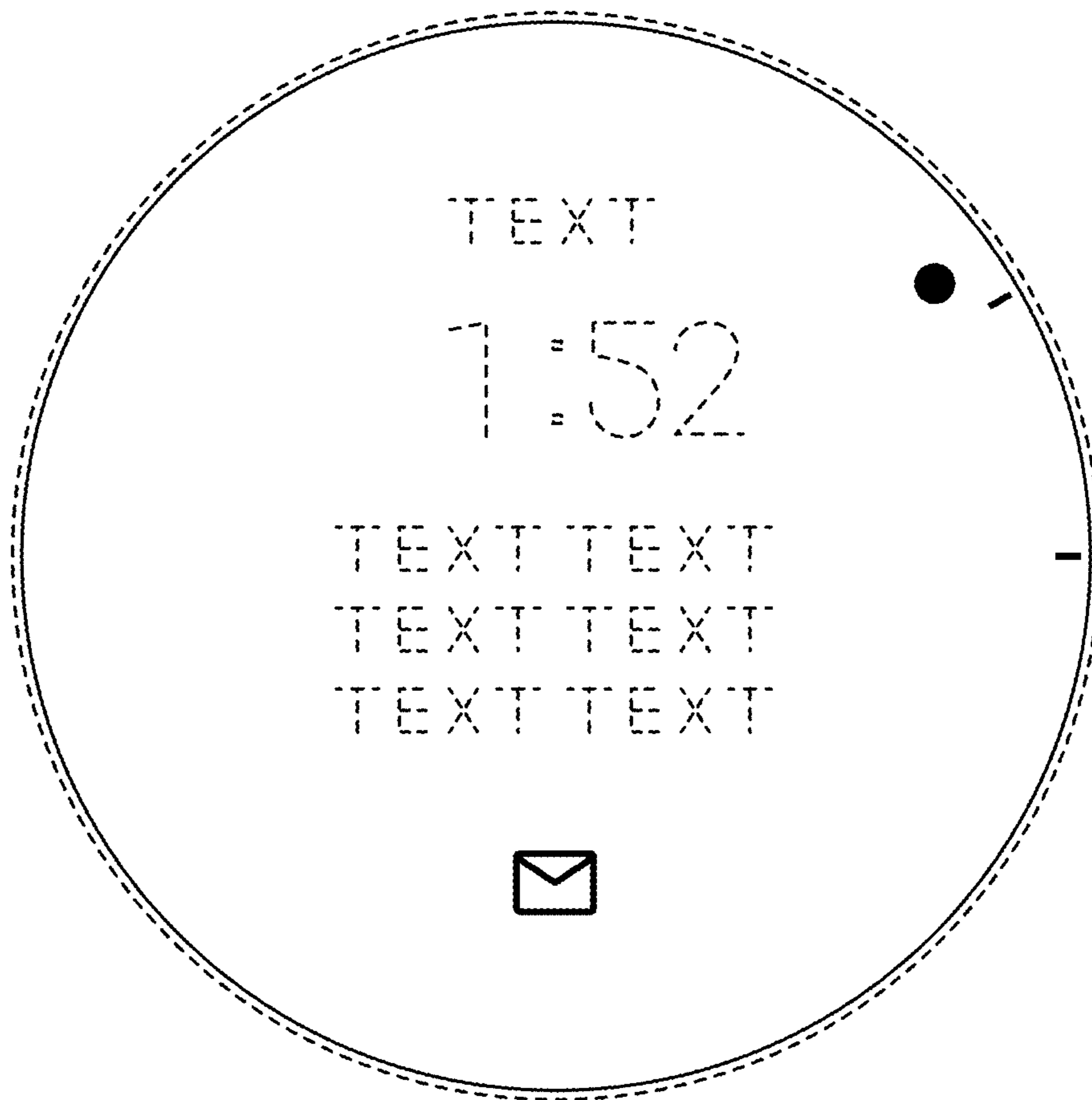

FIG. 9

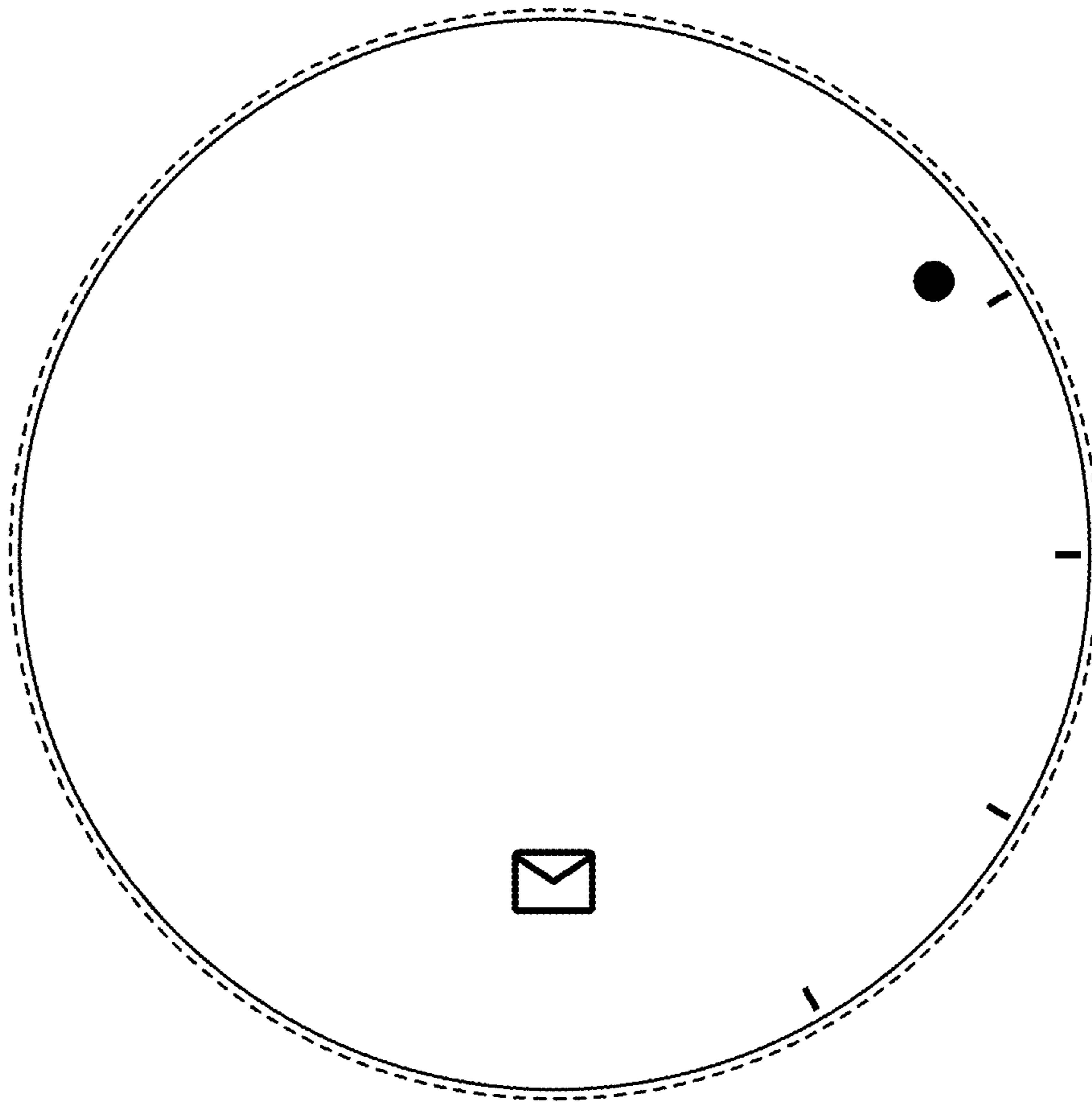

FIG. 10

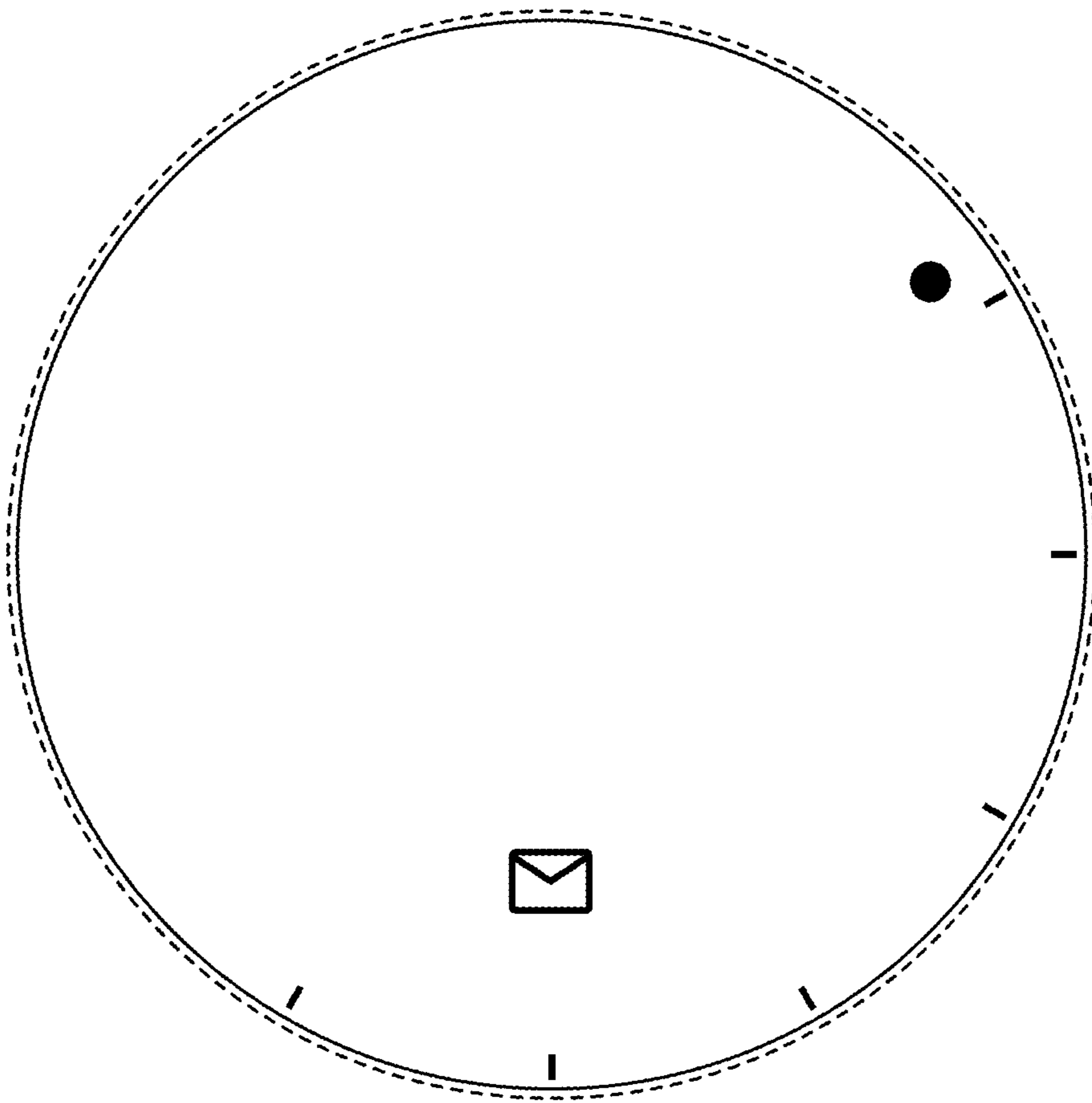

FIG. 11

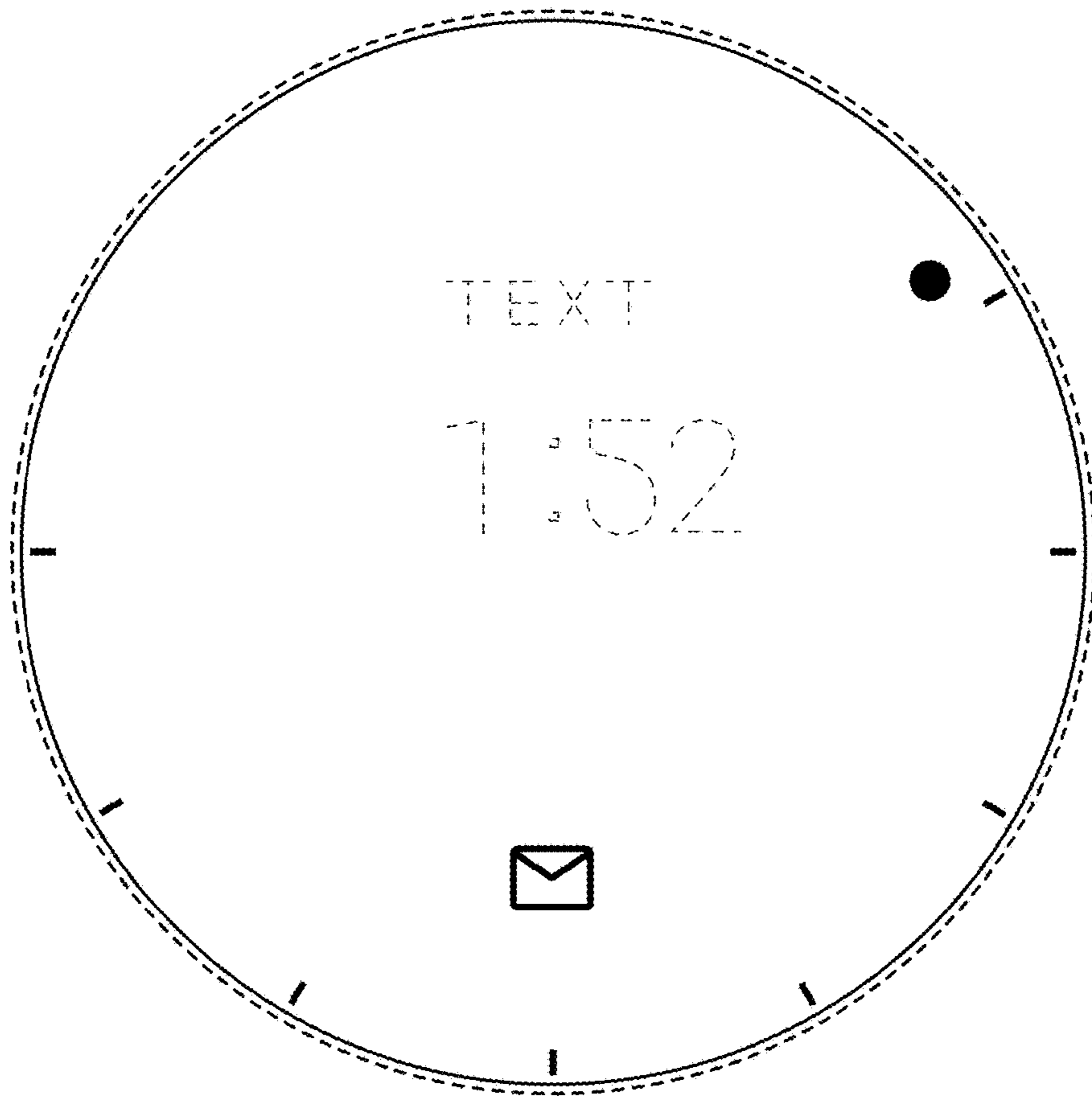

FIG. 12

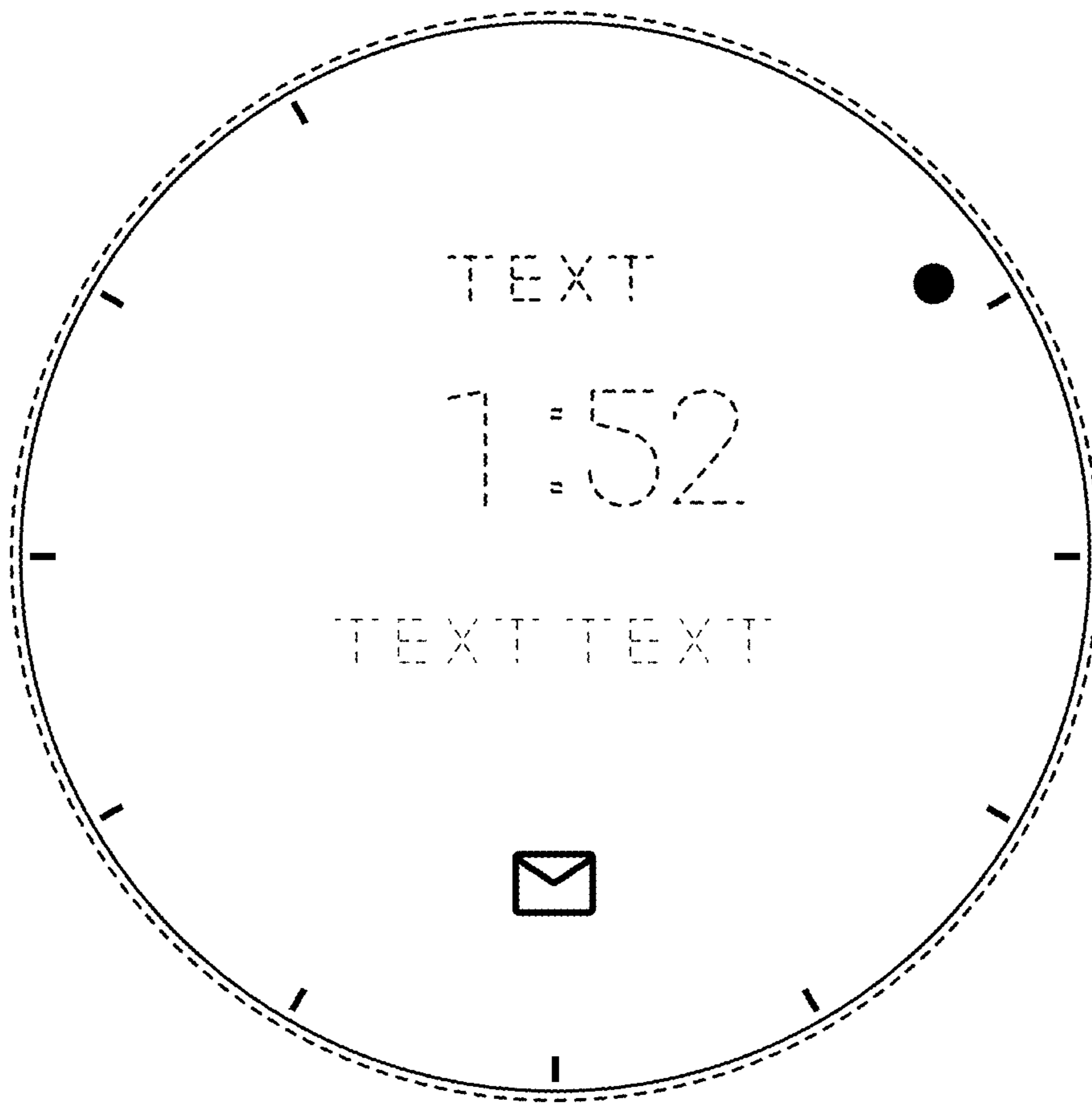

FIG. 13

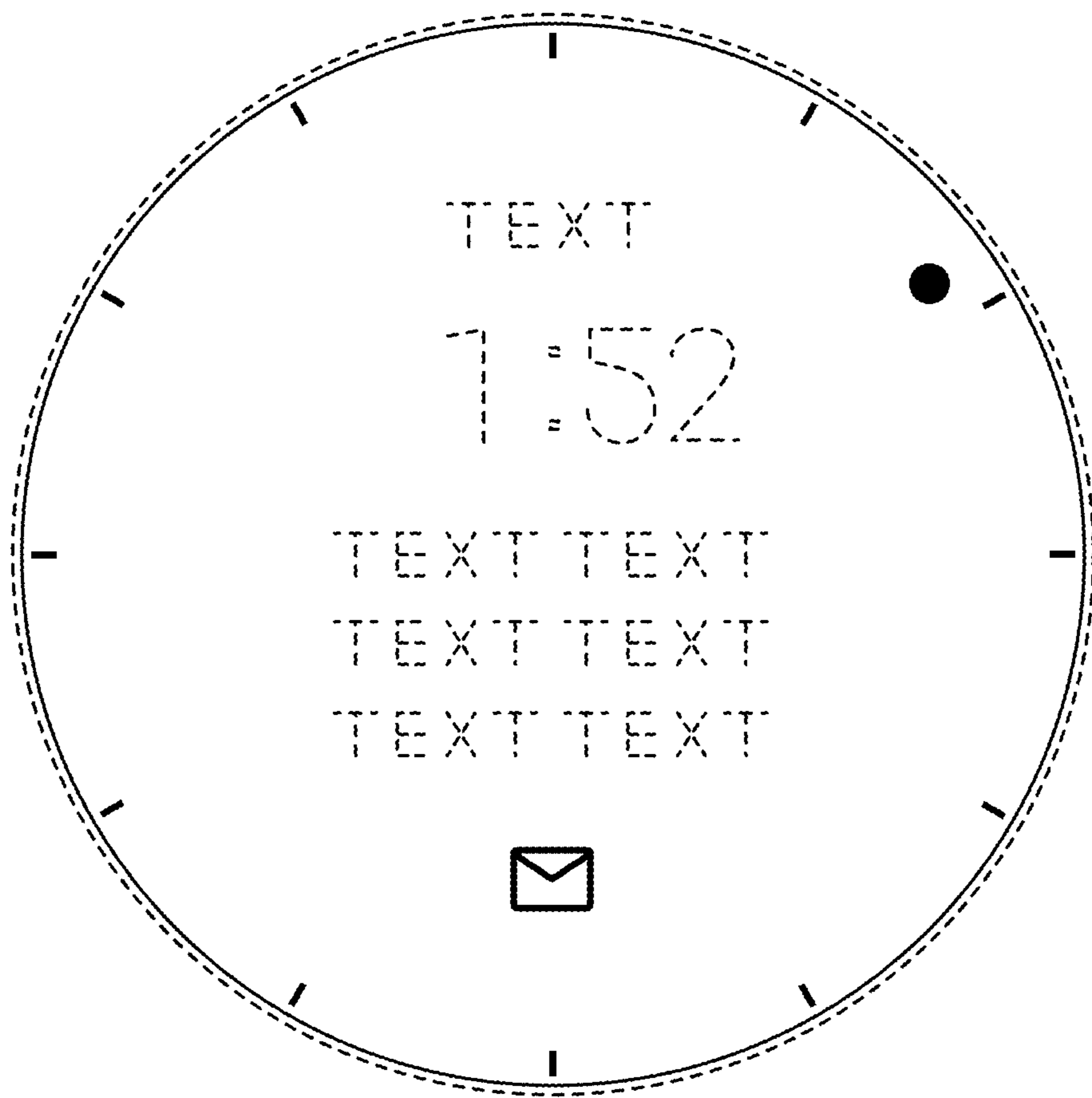

FIG. 14

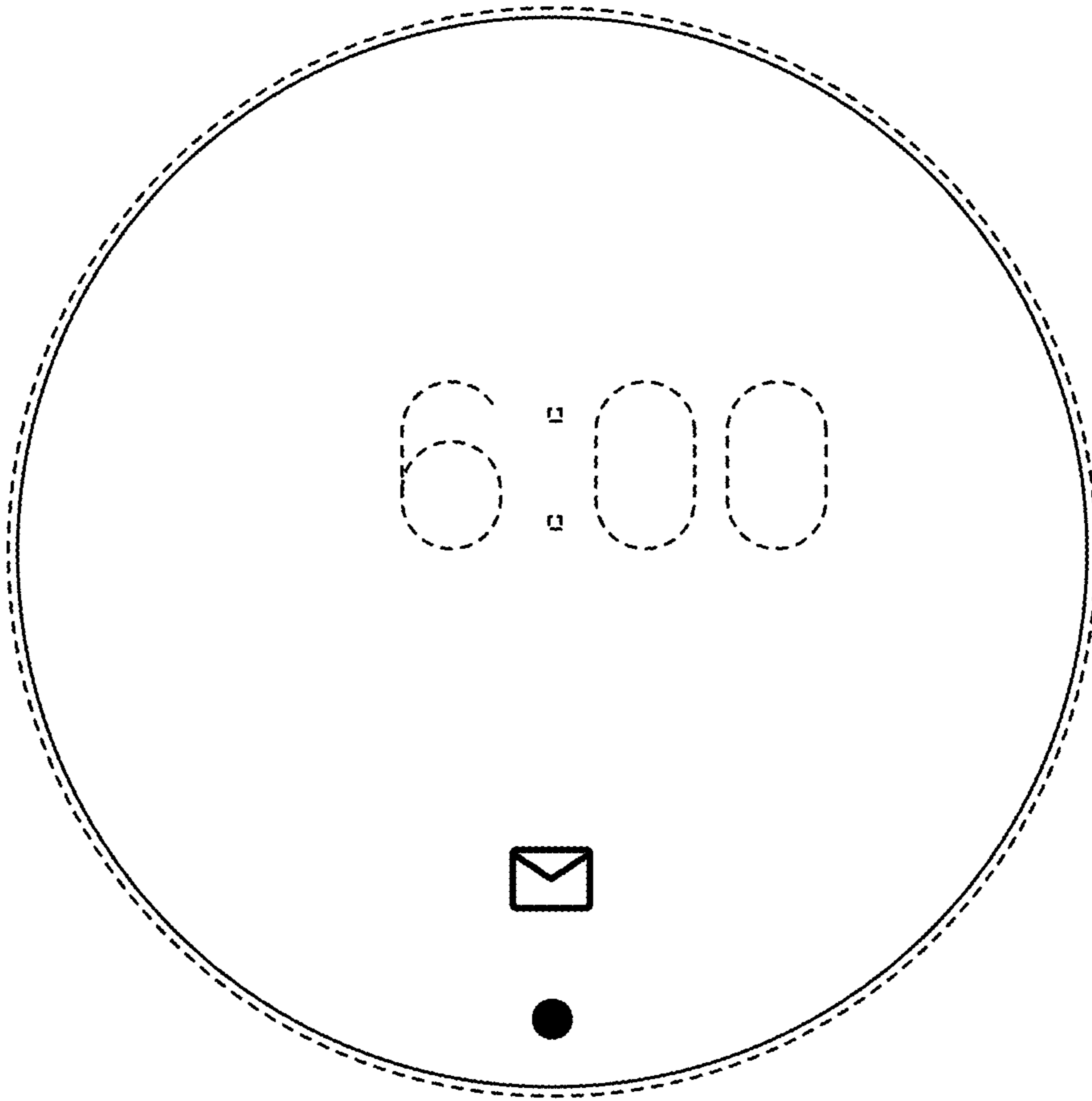

FIG. 15

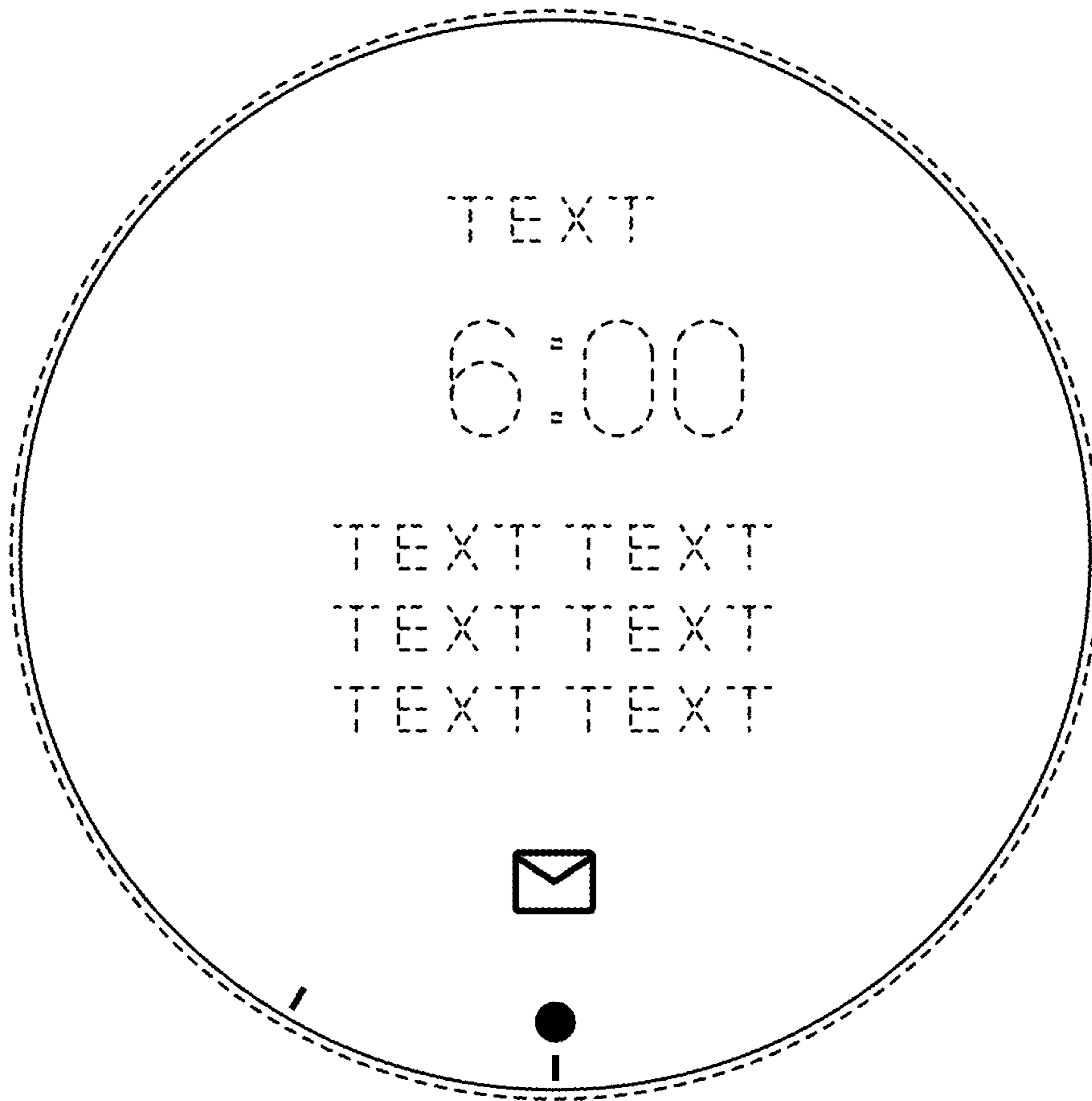

FIG. 16

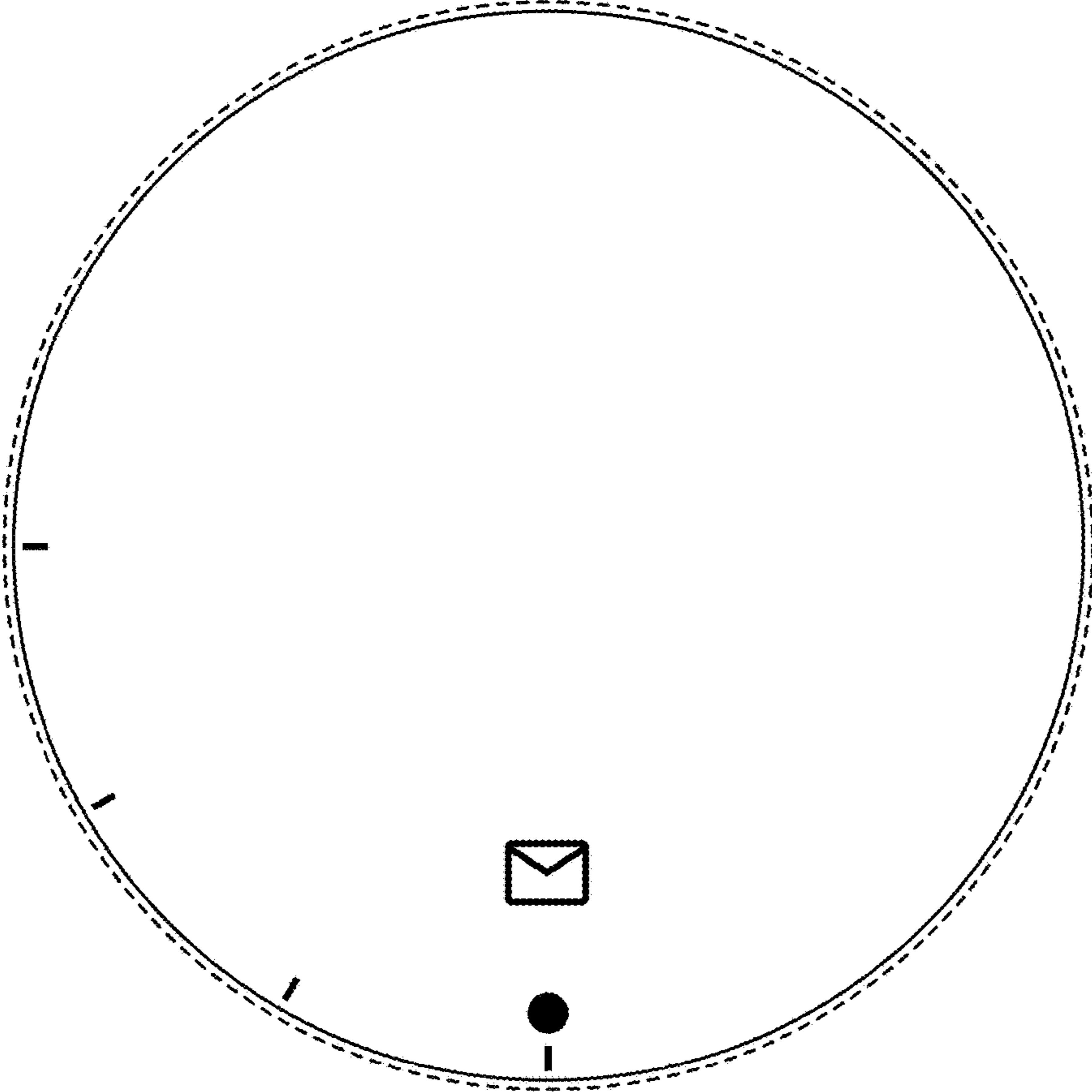

FIG. 17

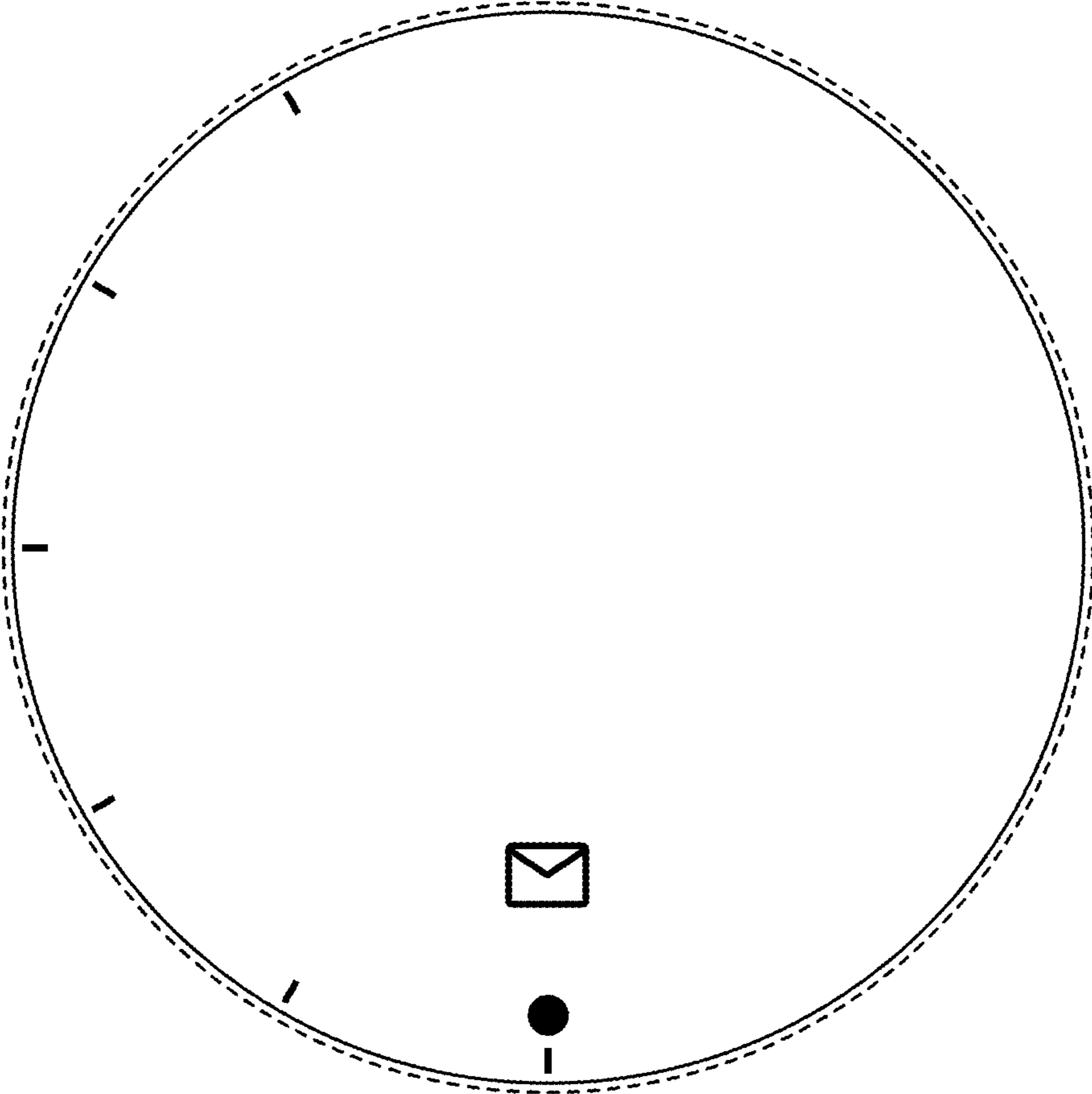

FIG. 18

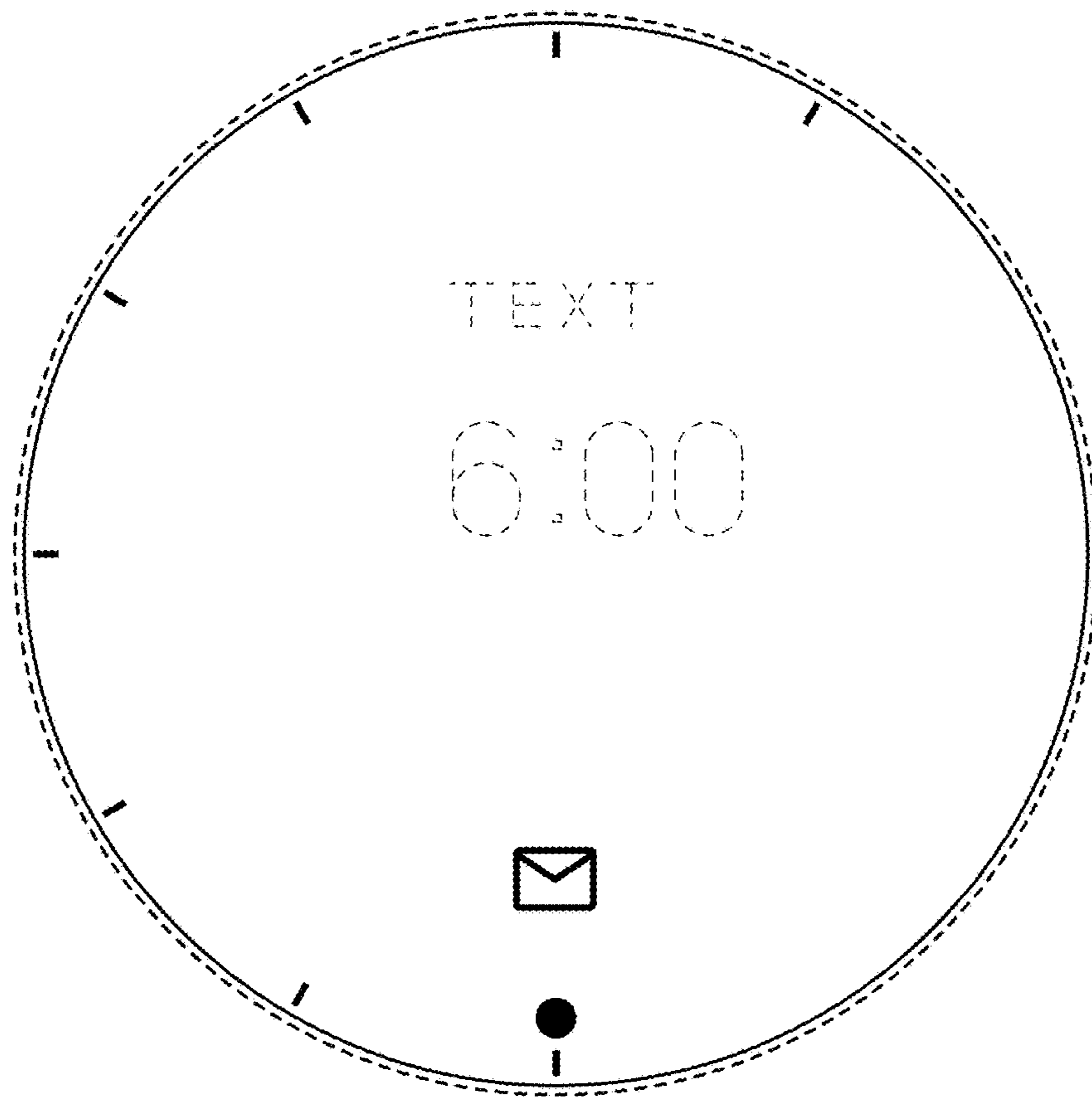

FIG. 19

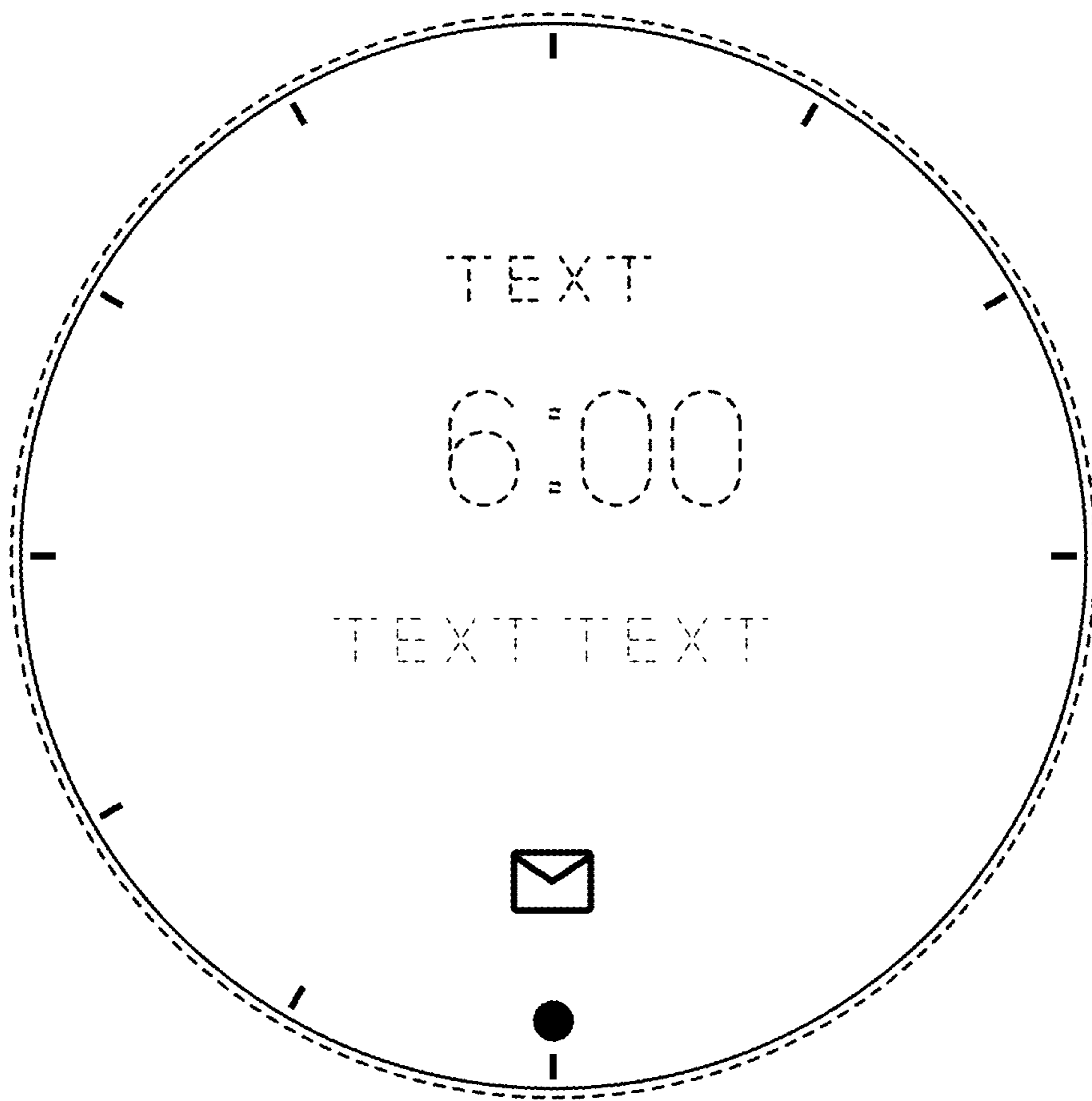

FIG. 20

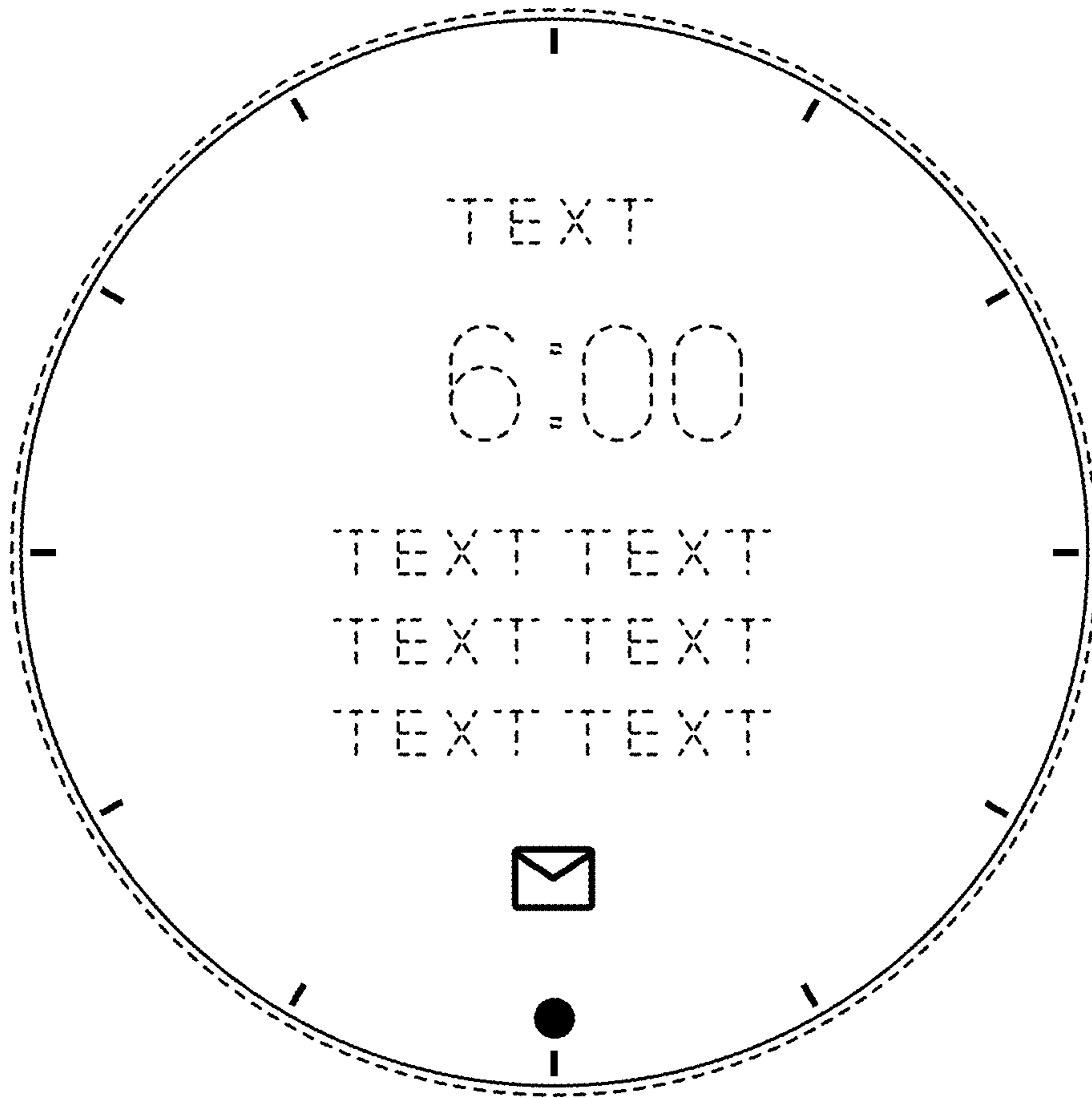

FIG. 21