



US00D800107S

(12) **United States Design Patent**  
**Godycki et al.**

(10) **Patent No.:** **US D800,107 S**

(45) **Date of Patent:** **\*\* Oct. 17, 2017**

(54) **MOBILE COMMUNICATIONS DEVICE CASE**

(71) Applicant: **Q Holdings LLC**, New York, NY (US)

(72) Inventors: **Przemek Godycki**, Brooklyn, NY (US);  
**Timothy M. Connelly**, Brooklyn, NY (US)

(73) Assignee: **Q HOLDINGS LLC**, New York, NY (US)

(\*\*) Term: **15 Years**

(21) Appl. No.: **29/581,827**

(22) Filed: **Oct. 21, 2016**

**Related U.S. Application Data**

(62) Division of application No. 29/498,923, filed on Aug. 8, 2014, now Pat. No. Des. 769,852, which is a division of application No. 29/439,255, filed on Dec. 7, 2012, now Pat. No. Des. 713,395.

(51) **LOC (10) Cl.** ..... **14-03**

(52) **U.S. Cl.**  
USPC ..... **D14/250**

(58) **Field of Classification Search**  
USPC ..... D14/238.1, 203.3–203.7, 217, 240, 447,  
D14/250, 440, 251–253, 248; D3/201,  
D3/218, 247, 269, 273, 301, 303;  
D13/103, 107–108, 119  
CPC ..... H04B 1/3888; H04M 1/0283; H04M  
1/0202; A45C 1/06; A45C 2011/002;  
A45C 11/00; A45C 13/02; A45F  
2005/026; A45F 2200/0525; A45F  
2200/0516

See application file for complete search history.

(56) **References Cited**

**U.S. PATENT DOCUMENTS**

4,925,149 A \* 5/1990 DiFrancesca ..... B65D 81/113  
206/320  
D473,563 S 4/2003 Russell

6,616,111 B1 9/2003 White  
D550,953 S \* 9/2007 Yang ..... D3/218  
D558,773 S 1/2008 Derry  
D560,068 S 1/2008 Dixon  
D564,220 S 3/2008 Dixon  
D592,188 S 5/2009 Huang  
D634,315 S \* 3/2011 Nousiainen ..... D14/253  
D637,593 S 5/2011 Zanetti  
D640,679 S \* 6/2011 Willes ..... D14/250  
D640,707 S 6/2011 Yeh  
D641,610 S \* 7/2011 Sedalo ..... D8/354  
D669,459 S \* 10/2012 Kim ..... D14/253  
D669,890 S 10/2012 Hopkins  
D673,960 S 1/2013 Lindfield  
D674,804 S 1/2013 Cote  
D679,693 S 4/2013 Rashid  
D685,376 S 7/2013 Kim  
D686,629 S 7/2013 Trinh  
D687,440 S \* 8/2013 Shieh ..... D14/447  
D691,148 S 10/2013 Weatherby, III

(Continued)

*Primary Examiner* — Carla Jobe Wright

(74) *Attorney, Agent, or Firm* — Hard IP LLC

(57) **CLAIM**

The ornamental design for a mobile communications device case, as shown.

**DESCRIPTION**

FIG. 1 is a front/right perspective view of a mobile communications device case showing our new design; FIG. 2 is a rear/left perspective view thereof; FIG. 3 is a front elevational view thereof; FIG. 4 is a rear elevational view thereof; FIG. 5 is a right elevational view thereof; FIG. 6 is a left elevational view thereof; FIG. 7 is a top plan view thereof; and, FIG. 8 is a bottom plan view thereof.

**1 Claim, 3 Drawing Sheets**

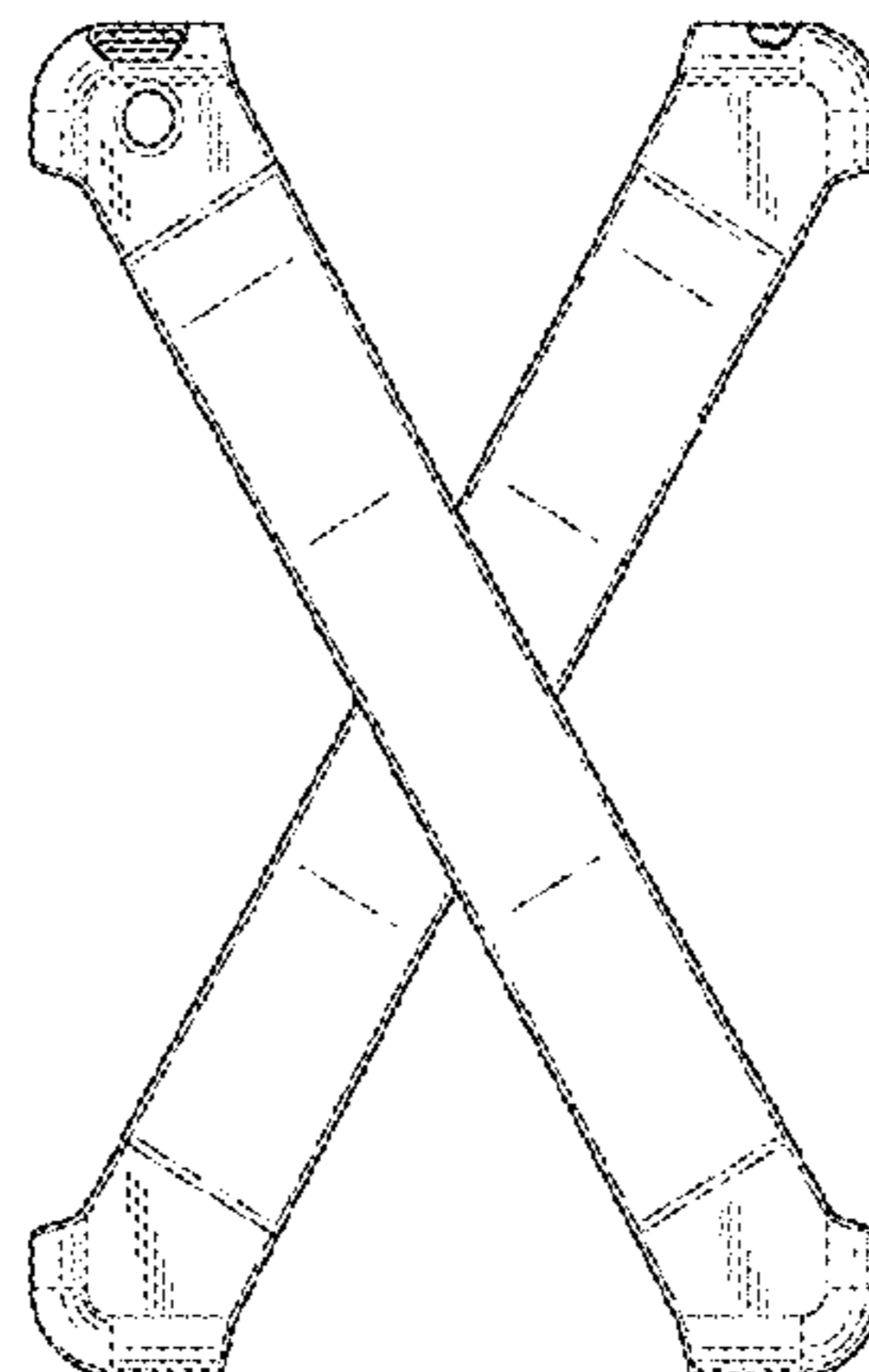
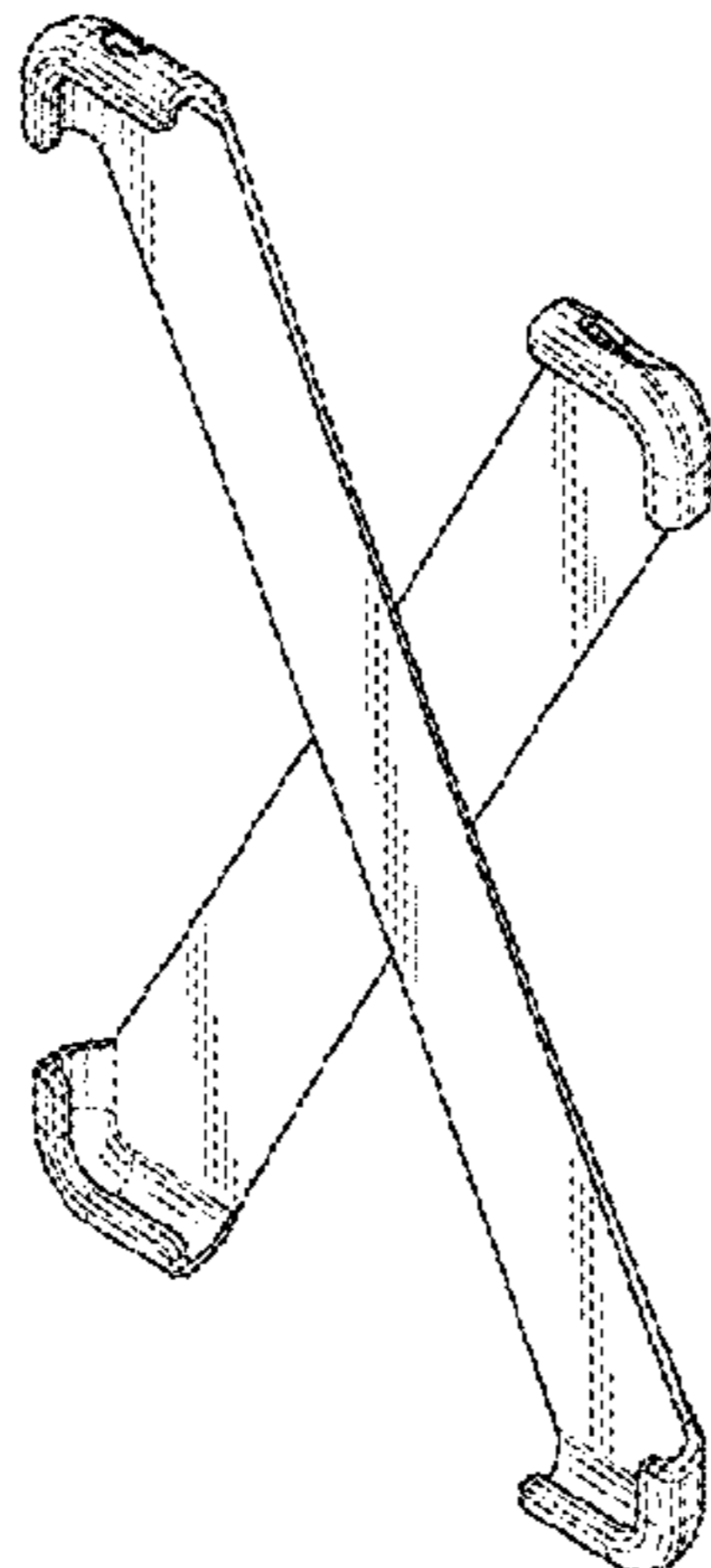

(56)

**References Cited**

U.S. PATENT DOCUMENTS

D691,991	S	*	10/2013	Mohan	.....	D14/250
D703,657	S		4/2014	Carnevali		
D704,194	S	*	5/2014	Young	.....	D14/440
D713,395	S		9/2014	Godycki		
D716,044	S		10/2014	Wilk		
D719,144	S		12/2014	Eulette		
D719,951	S	*	12/2014	Fenton	.....	D14/253
D721,690	S	*	1/2015	Kim	.....	D14/250
D721,691	S	*	1/2015	Kim	.....	D14/250
D721,692	S	*	1/2015	Kim	.....	D14/250
D725,093	S	*	3/2015	Sun	.....	D14/250
D750,087	S		2/2016	Wu		
D751,284	S		3/2016	Kishimoto		
D764,478	S	*	8/2016	Radmard	.....	H04M 1/185 D14/250
D768,137	S	*	10/2016	Ju	.....	D14/440
D769,852	S	*	10/2016	Godycki	.....	D14/250
D769,854	S	*	10/2016	Duval	.....	D14/250
D775,618	S	*	1/2017	Kim	.....	D14/250
2010/0294908	A1		11/2010	Mish		
2013/0270850	A1		10/2013	Fan		
2014/0141846	A1*		5/2014	Weaver, III	.....	H04M 1/035 455/575.1
2014/0217862	A1*		8/2014	Rayner	.....	G06F 1/1601 312/223.1
2016/0020809	A1		1/2016	Joslin		

\* cited by examiner

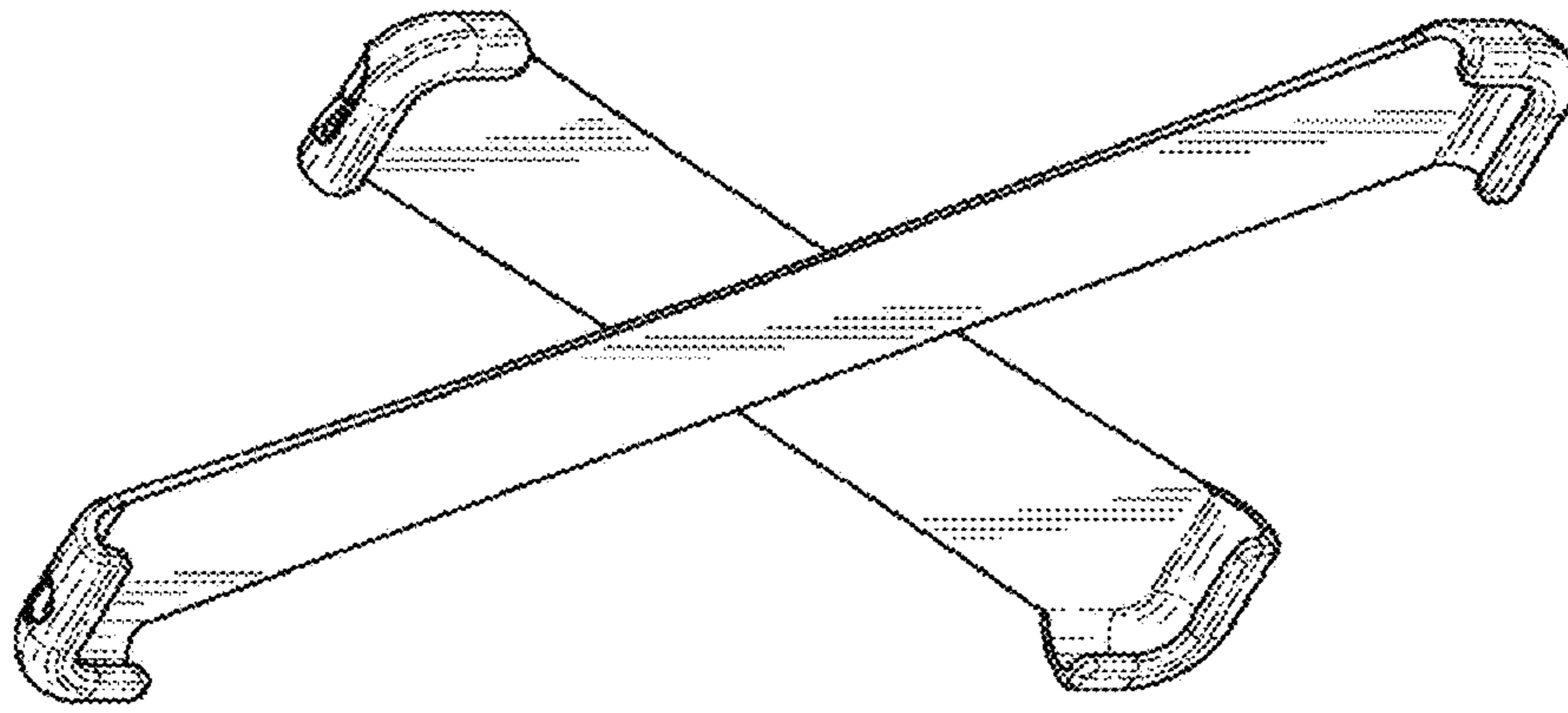

FIG. 2

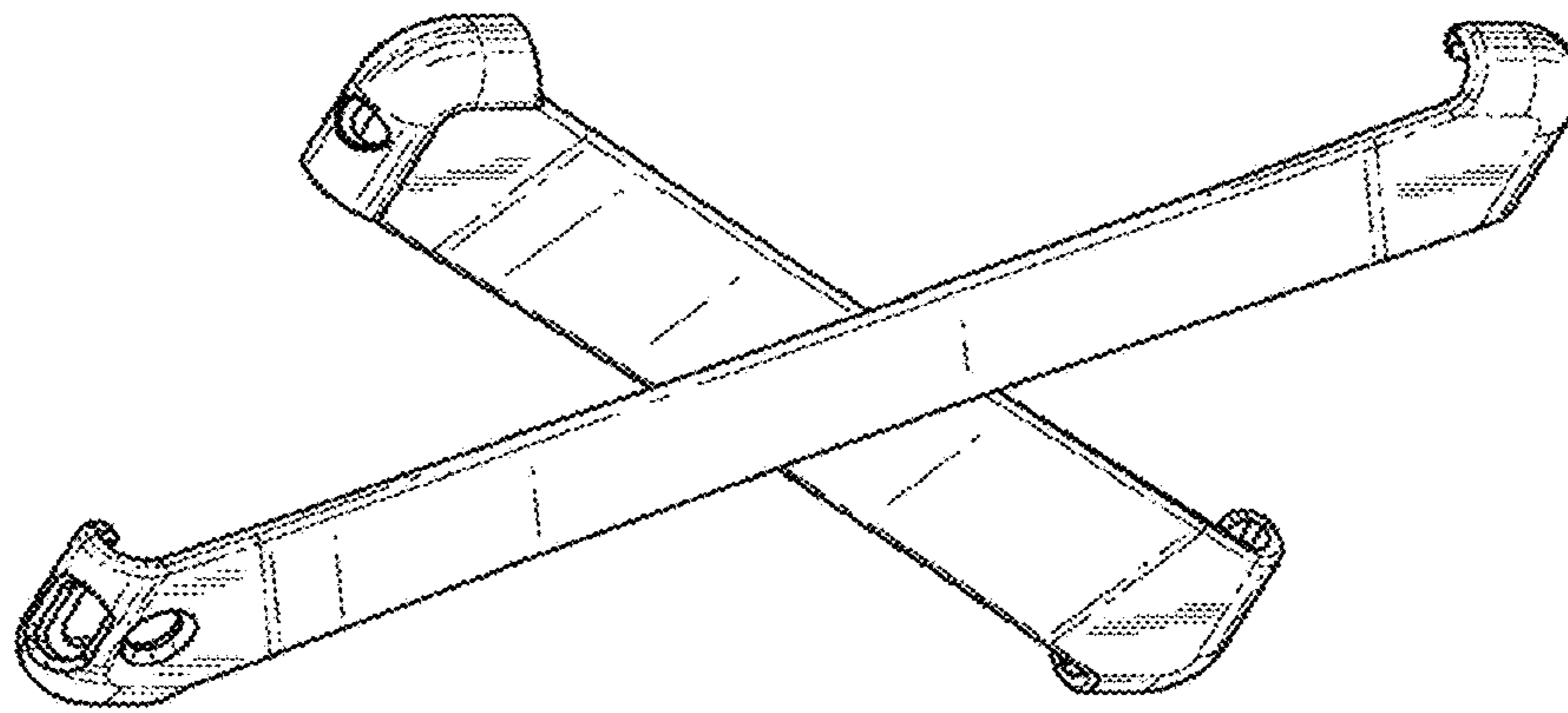

FIG. 1

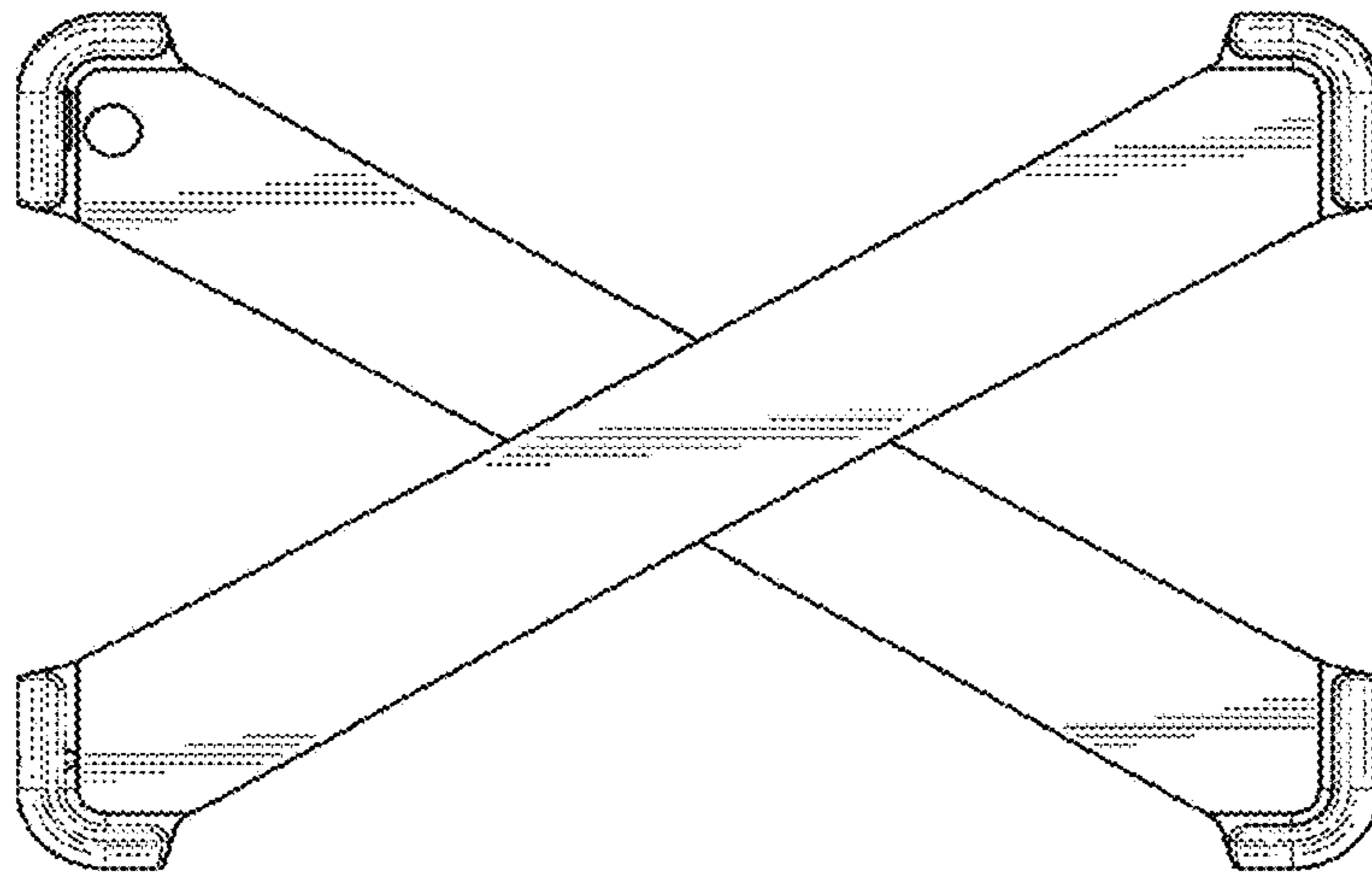

FIG. 4

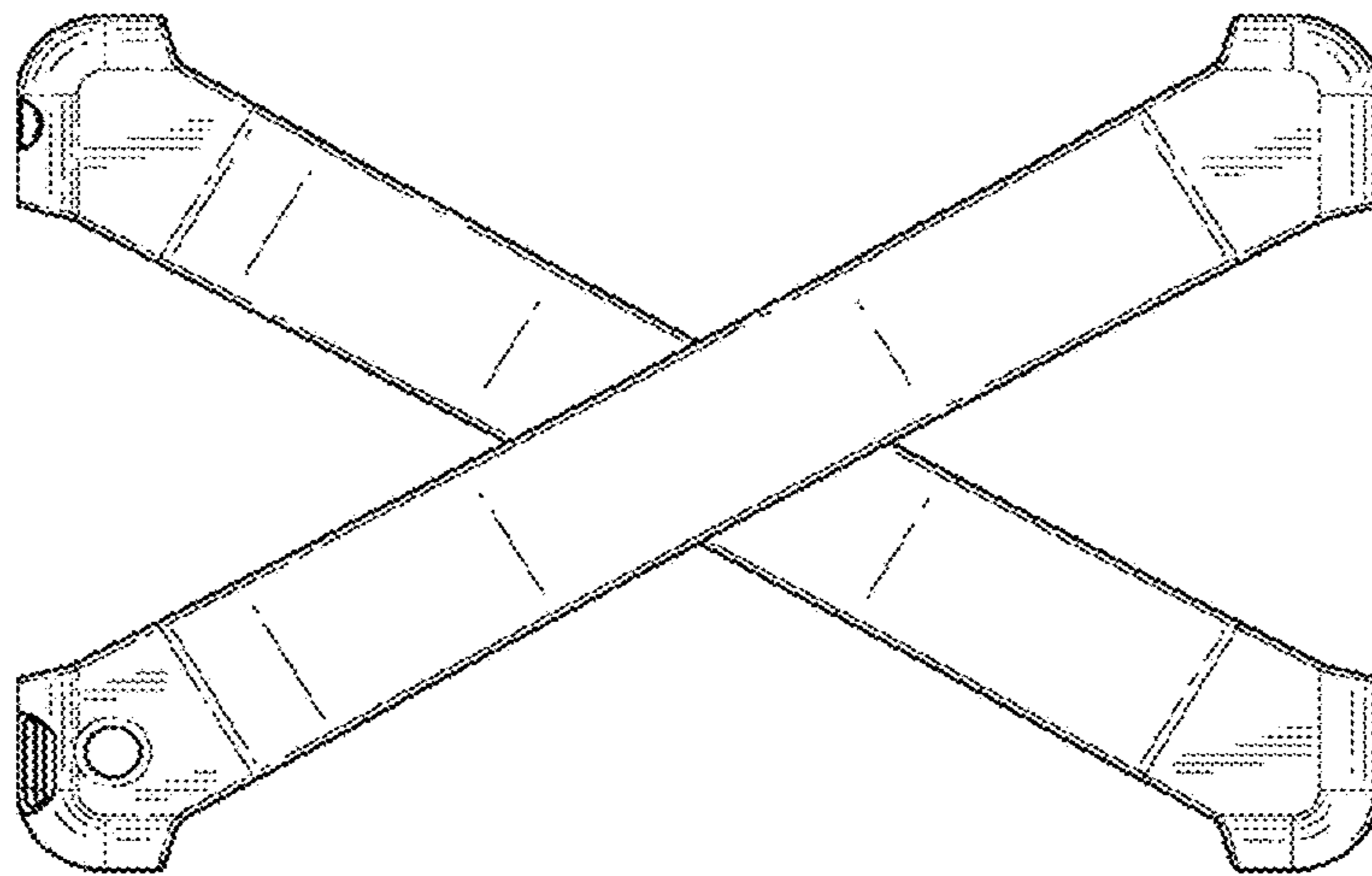

FIG. 3

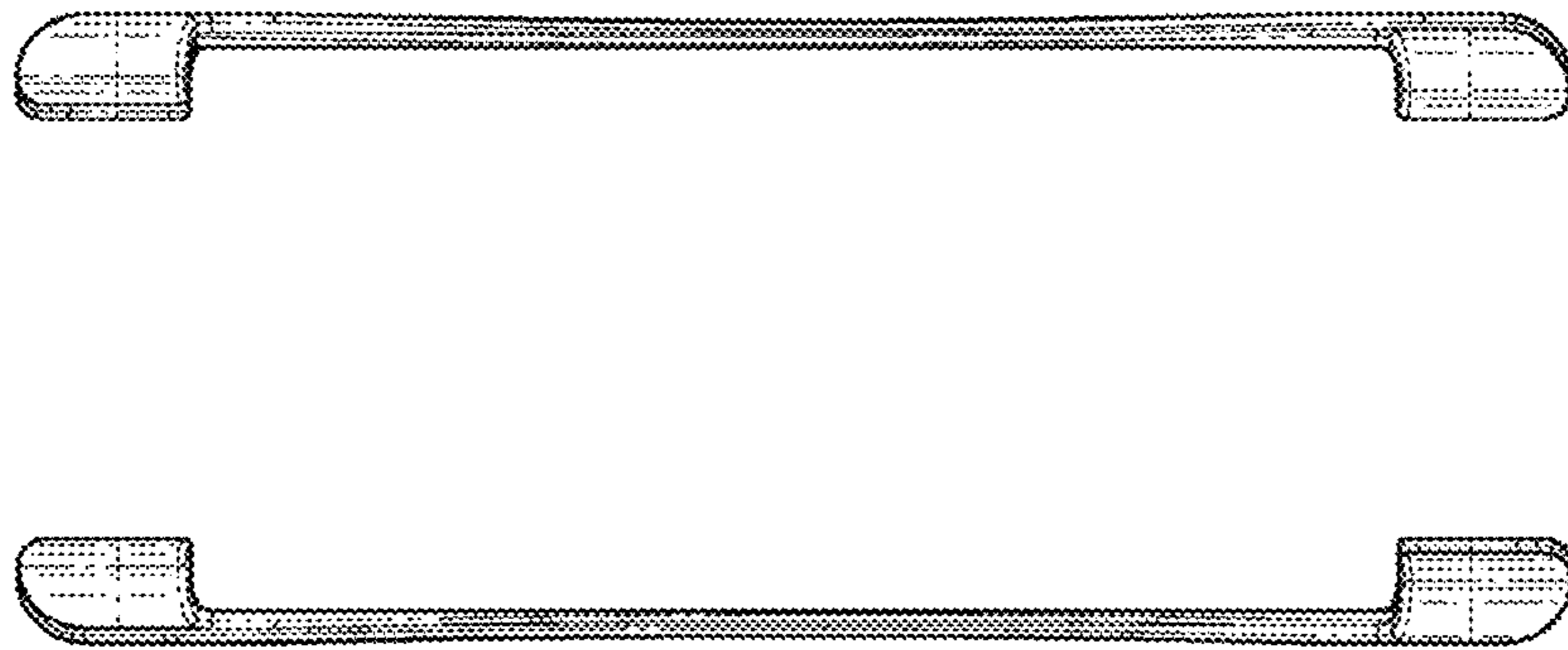

FIG. 5

FIG. 6

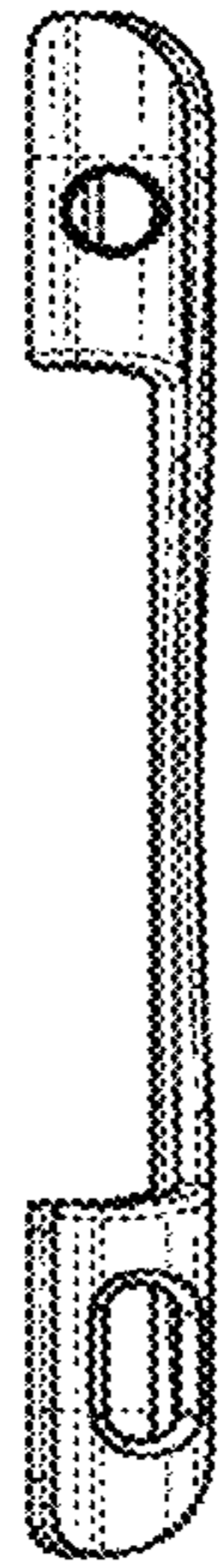

FIG. 7

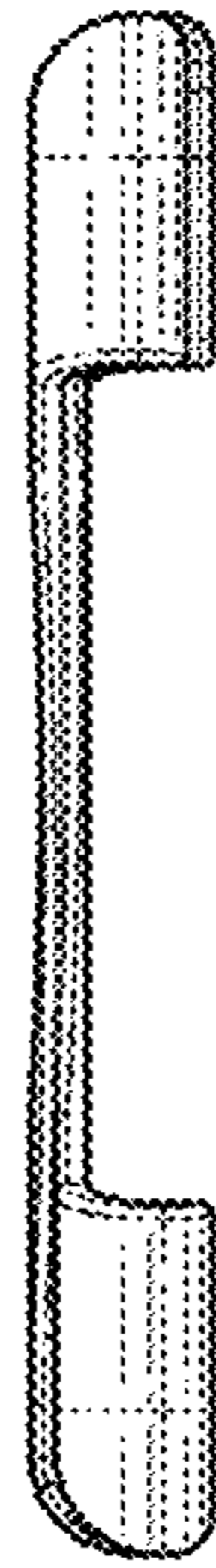

FIG. 8