



US00D800020S

(12) **United States Design Patent**
Manzoni

(10) **Patent No.:** **US D800,020 S**
(45) **Date of Patent:** **** Oct. 17, 2017**

(54) **CAR INCLUDING TOY-CAR, MOTOR CAR, REPLICA CAR AND SCALE-MODEL-CAR**

(71) Applicant: **Ferrari S.p.A.**, Modena (IT)

(72) Inventor: **Flavio Manzoni**, Maranello (IT)

(73) Assignee: **Ferrari S.p.A.**, Modena (IT)

(**) Term: **15 Years**

(21) Appl. No.: **29/573,328**

(22) Filed: **Aug. 4, 2016**

(30) **Foreign Application Priority Data**

Feb. 5, 2016 (EM) 001448617
Feb. 5, 2016 (EM) 002974873

(51) **LOC (10) Cl.** **12-08**

(52) **U.S. Cl.**
USPC **D12/91**

(58) **Field of Classification Search**
USPC D12/90-92, 164, 169, 196;
296/181.1-181.5; D21/548, 560
CPC B60Y 2306/01; B60K 11/085
See application file for complete search history.

(56) **References Cited**

U.S. PATENT DOCUMENTS

D629,718 S * 12/2010 Reichman D12/92
D673,079 S * 12/2012 Goto D12/92

D692,348 S * 10/2013 Whelan D12/92
D704,102 S * 5/2014 Nurnberger D12/92
D710,257 S * 8/2014 Giovannini D12/92
D718,665 S * 12/2014 Menegon D12/92
D727,212 S * 4/2015 Menegon D12/92
D731,928 S * 6/2015 Manzoni D12/92
D744,903 S * 12/2015 Jelec D12/92
D745,439 S * 12/2015 Manzoni D12/92
D774,950 S * 12/2016 Holgate D12/92
D781,748 S * 3/2017 Manzoni D12/88
2002/0093220 A1 * 7/2002 Borghi B62D 35/005
296/180.5

* cited by examiner

Primary Examiner — John Windmuller

Assistant Examiner — Melvin L Davis

(74) *Attorney, Agent, or Firm* — Cowan, Liebowitz & Latman, P.C.

(57) **CLAIM**

The ornamental design for a car including toy-car, motor car, replica car and scale-model-car, as shown and described.

DESCRIPTION

FIG. 1 is a front perspective view of the car including toy-car, motor car, replica car and scale-model-car showing my design thereof;

FIG. 2 is a rear perspective view thereof;

FIG. 3 is a front view thereof;

FIG. 4 is a rear view thereof;

FIG. 5 is a lateral view thereof, the opposite lateral views being identical to one another; and,

FIG. 6 is a top plan view thereof.

1 Claim, 6 Drawing Sheets

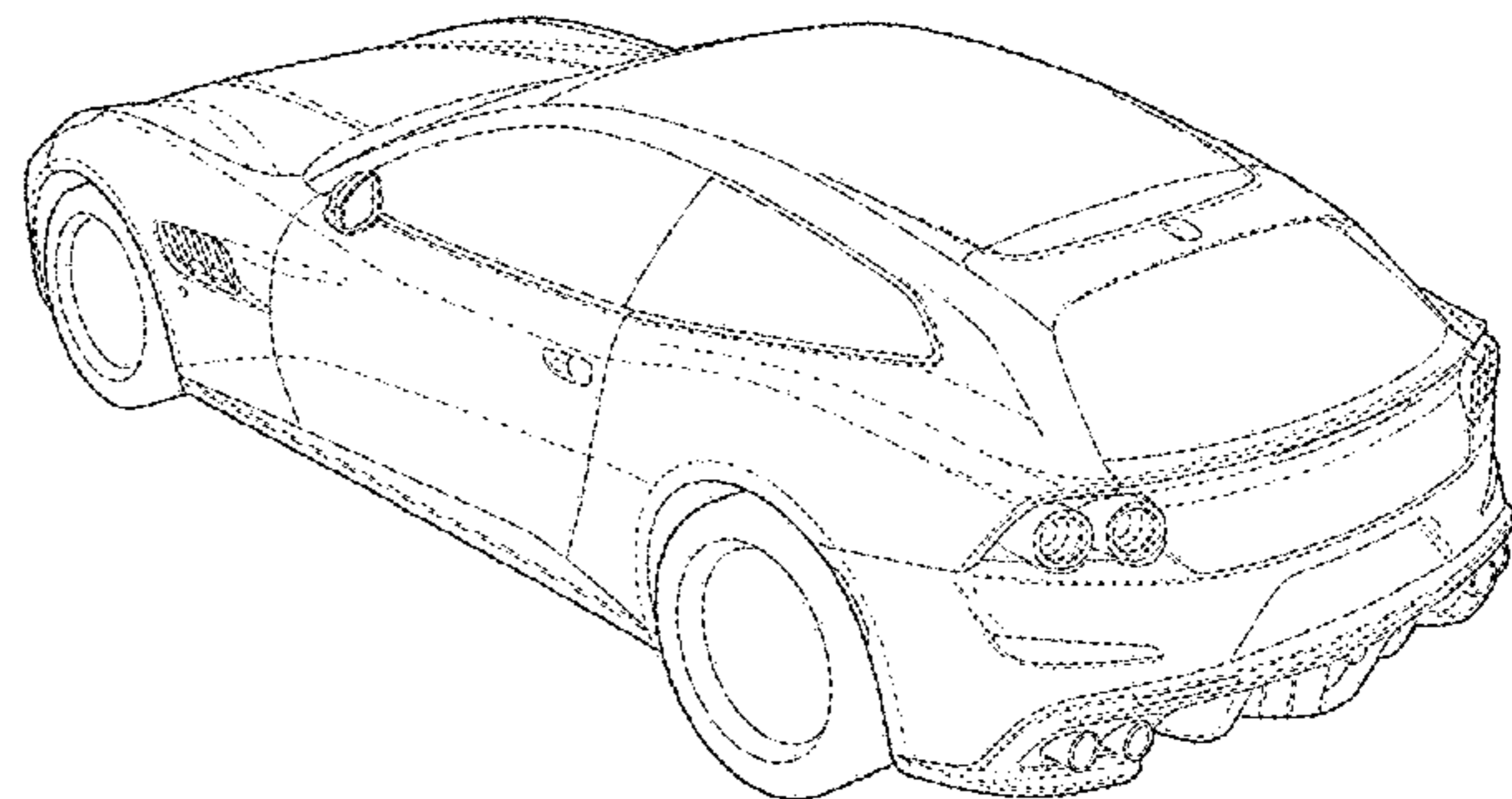
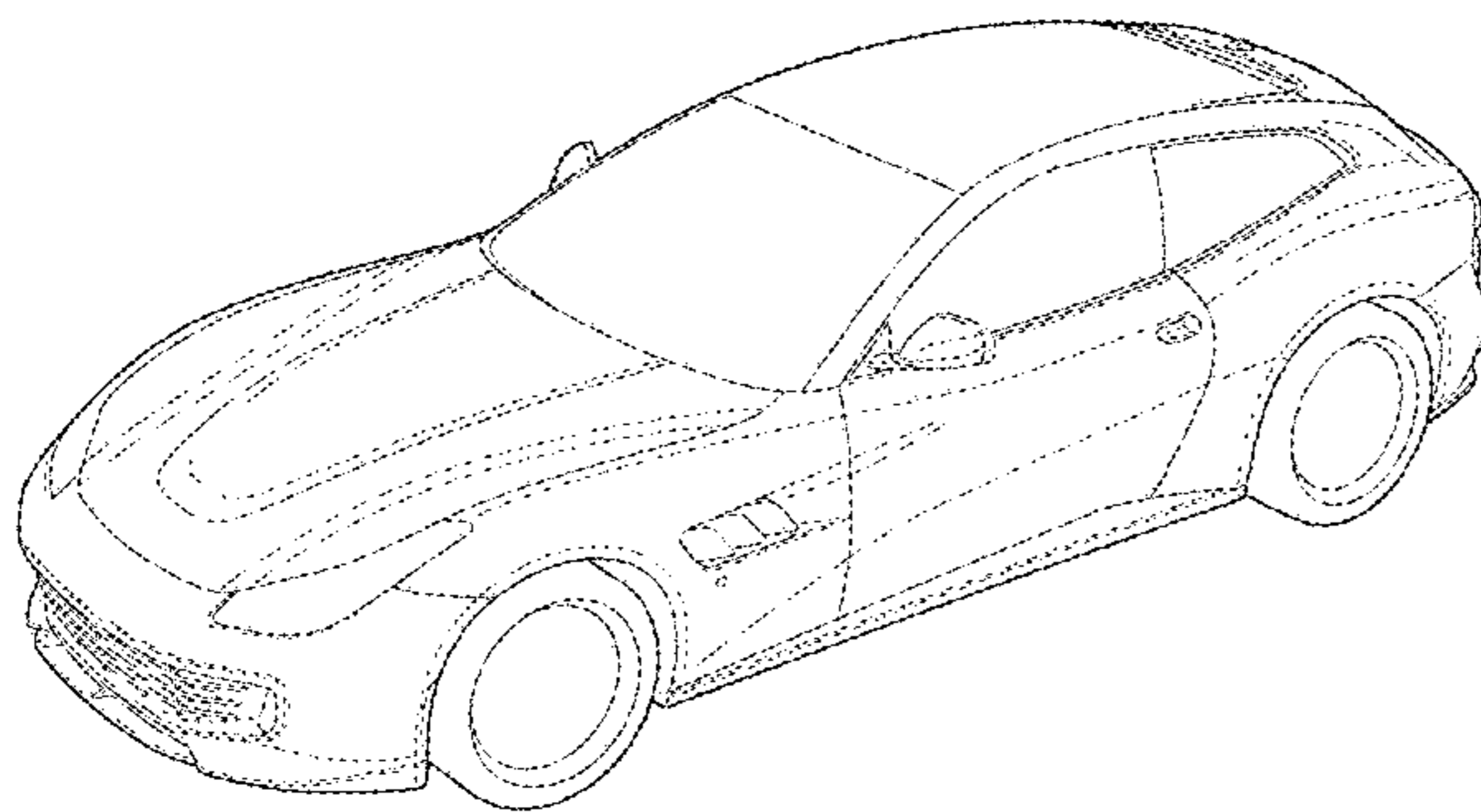

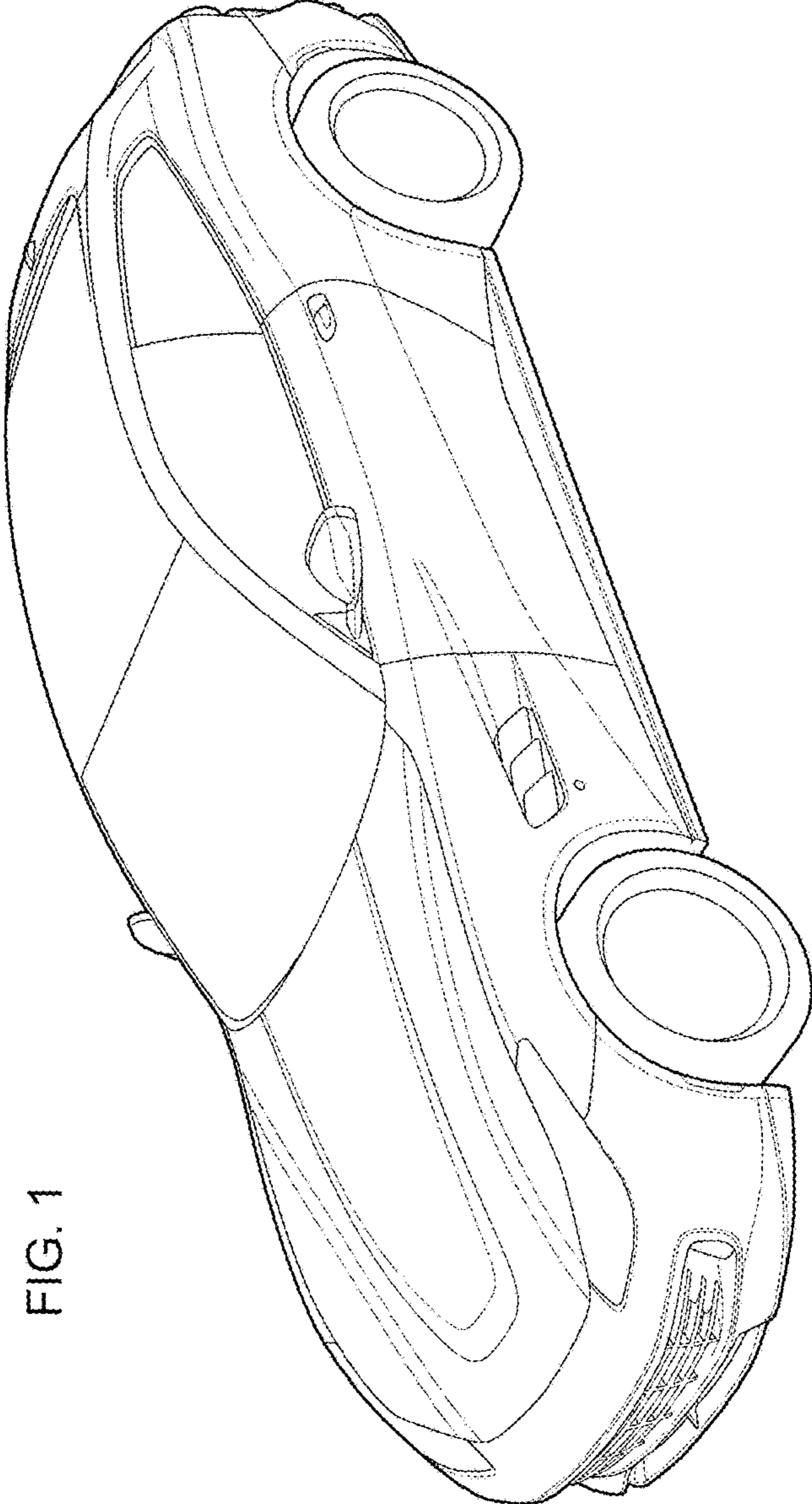

FIG. 1

FIG. 2

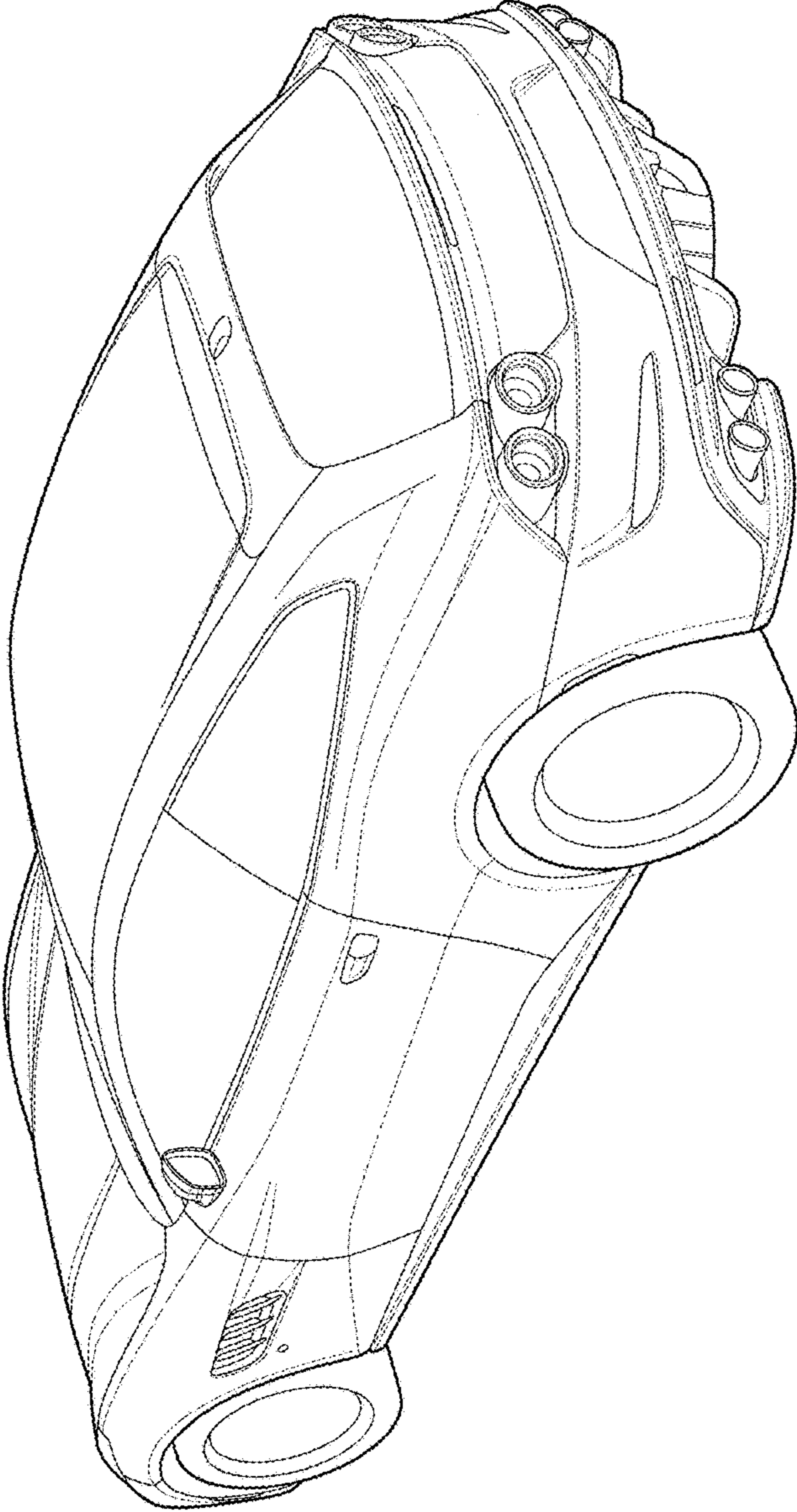

FIG. 3

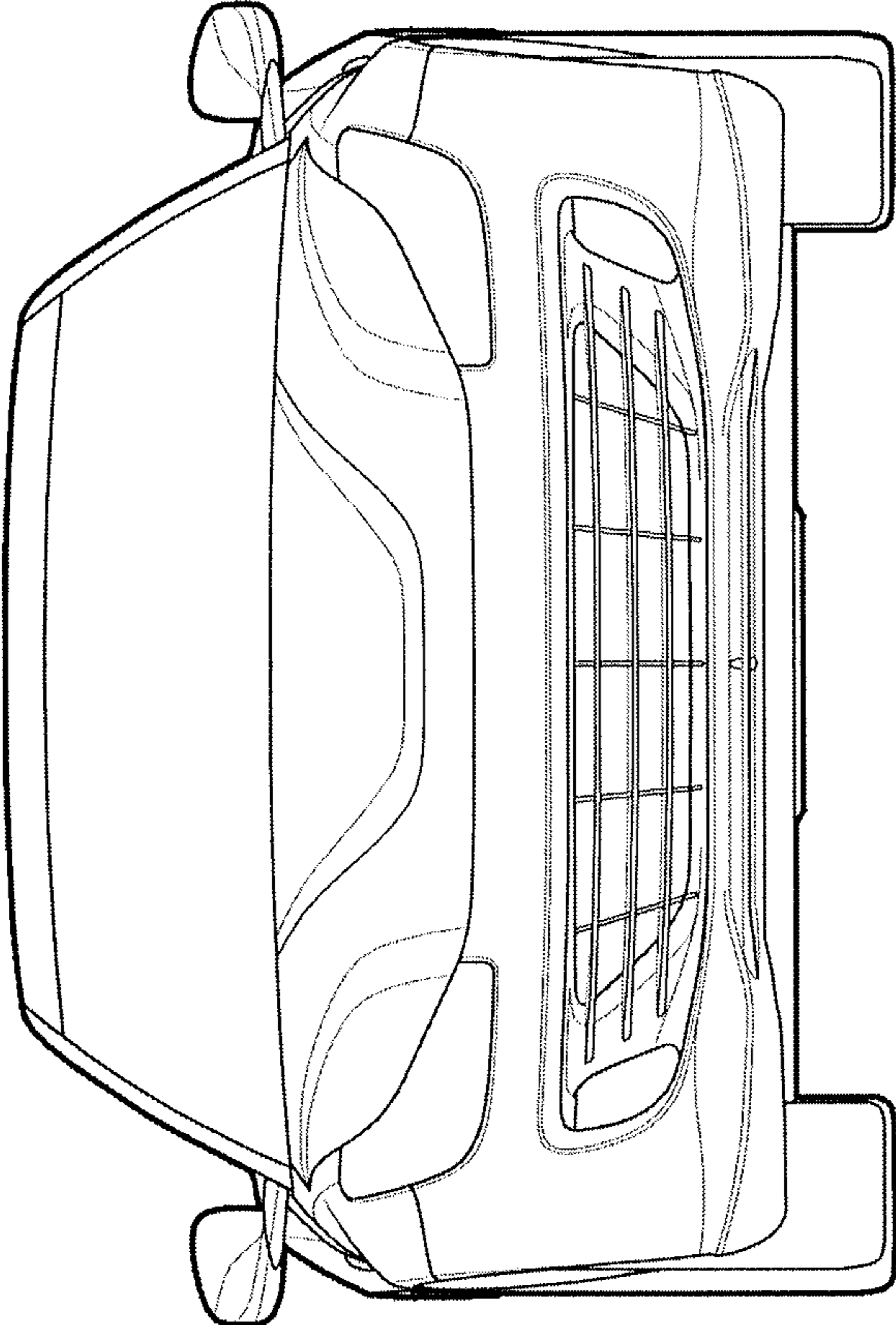

FIG. 4

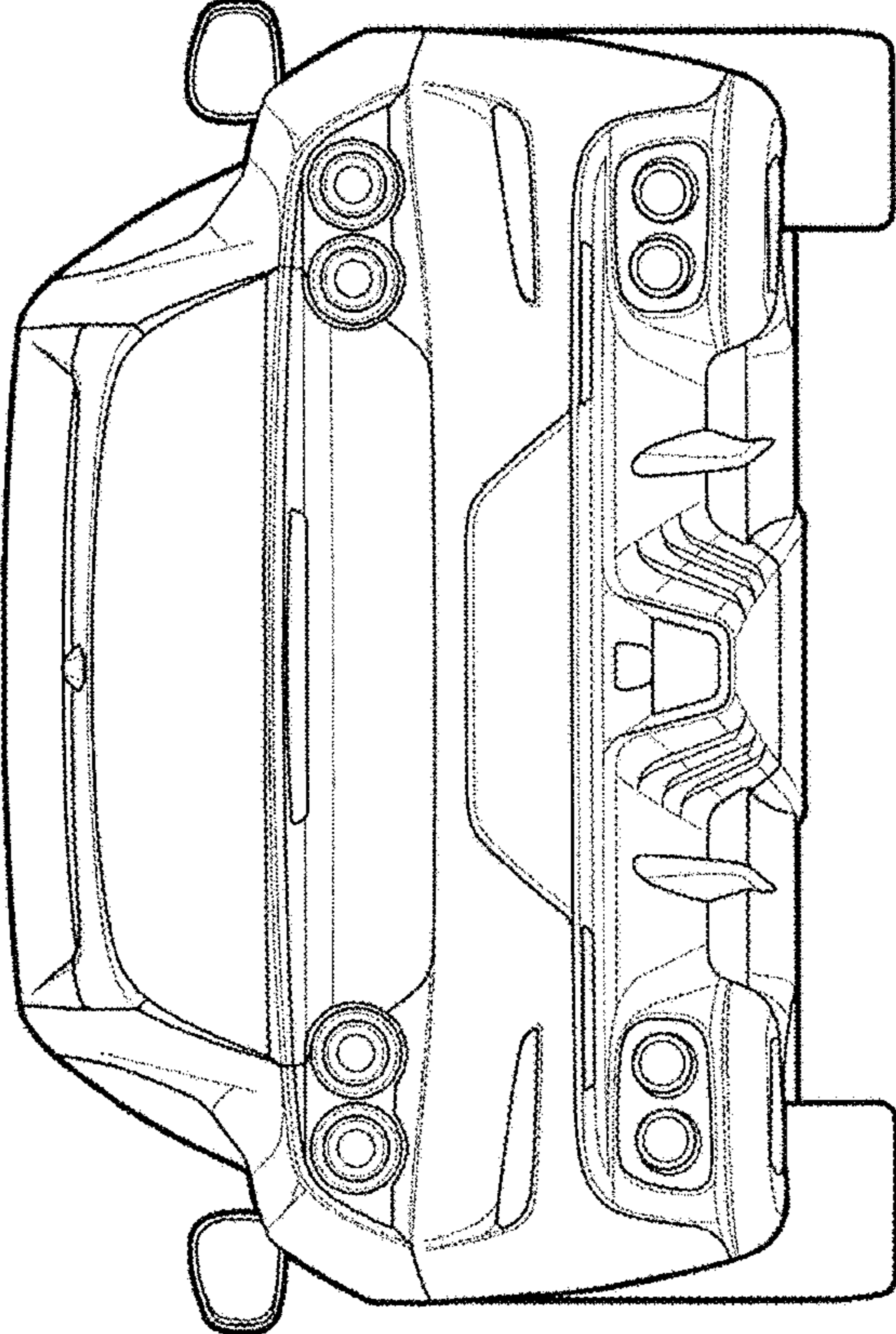

FIG. 5

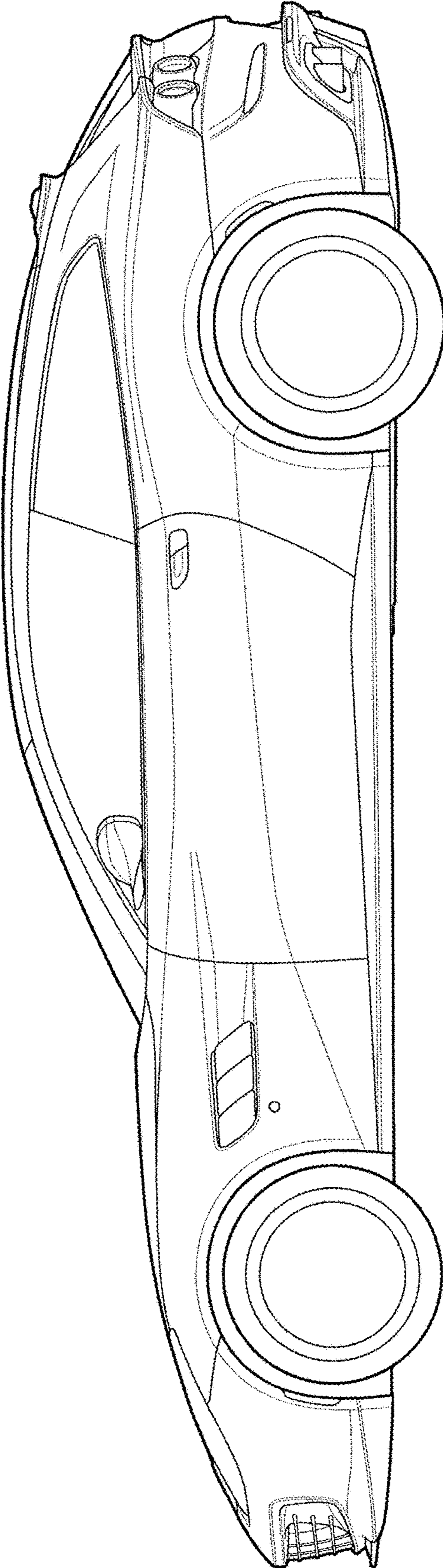

FIG. 6

