



US00D799973S

(12) **United States Design Patent**  
**Sorensen et al.**

(10) **Patent No.:** **US D799,973 S**  
(45) **Date of Patent:** **\*\* Oct. 17, 2017**

- (54) **CONTAINER**
- (71) Applicant: **RUNWAY BLUE, LLC**, Lehi, UT (US)
- (72) Inventors: **Steven M. Sorensen**, Alpine, UT (US);  
**Kim L. Sorensen**, Apline, UT (US);  
**David O. Meyers**, East Layton, UT (US)
- (73) Assignee: **Runway Blue, LLC.**, Alpine, UT (US)

6,494,056 B1 \* 12/2002 Roth ..... A45F 3/16  
62/457.3  
D519,843 S \* 5/2006 Forte ..... D9/556  
8,028,847 B2 \* 10/2011 Klaver ..... A61J 9/00  
215/11.1  
8,061,158 B2 \* 11/2011 Roth ..... F25D 3/08  
62/457.3  
D653,082 S \* 1/2012 George ..... D7/510  
8,113,364 B1 \* 2/2012 Asadi ..... A61J 9/008  
215/11.1

(\*\*) Term: **15 Years**

(21) Appl. No.: **29/539,279**

(22) Filed: **Sep. 11, 2015**

(51) **LOC (10) Cl.** ..... **09-01**

(52) **U.S. Cl.**  
USPC ..... **D9/529**; D9/549

(58) **Field of Classification Search**  
USPC ..... D7/300.1, 312, 619, 622; D9/516, 530,  
D9/537, 540, 547-549, 550, 552, 557,  
D9/575; D24/197; 132/293;  
215/381-385, 396, 398; 220/296, 288,  
220/300, 669, 675  
CPC ..... A61J 9/00; A61J 9/008; A61J 9/08; A61J  
11/04; B65D 1/00; B65D 1/02; B65D  
1/16; B65D 1/0223; B65D 1/0246; B65D  
41/00; B65D 41/02; B65D 41/04; B65D  
50/00; B65D 81/3211; B65D 2501/00;  
B65D 2501/0009

See application file for complete search history.

(56) **References Cited**

**U.S. PATENT DOCUMENTS**

D283,920 S \* 5/1986 Chen ..... D24/197  
4,778,068 A \* 10/1988 Kohus ..... A61J 9/00  
215/11.1  
6,247,586 B1 \* 6/2001 Herzog ..... B65D 81/3211  
206/221  
D447,004 S \* 8/2001 Green ..... D7/510

(Continued)

**OTHER PUBLICATIONS**

Office Action from Korean Application No. 30-2016-0006267 dated May 27, 2016.

(Continued)

*Primary Examiner* — Derrick Holland

*Assistant Examiner* — Janice Lim

(74) *Attorney, Agent, or Firm* — Maschoff Brennan

(57) **CLAIM**

The ornamental design for a container, as shown and described.

**DESCRIPTION**

FIG. 1 is an exploded top perspective view of a container, showing our new design;  
FIG. 2 is a top perspective view of the container;  
FIG. 3 is a bottom perspective view of the container;  
FIG. 4 is a front view of the container;  
FIG. 5 is a rear view of the container;  
FIG. 6 is a left side view of the container;  
FIG. 7 is a right side view of the container;  
FIG. 8 is a top view of the container; and,  
FIG. 9 is a bottom view of the container.

The broken line portions are included to show unclaimed subject matter only and form no part of the claimed design.

**1 Claim, 8 Drawing Sheets**

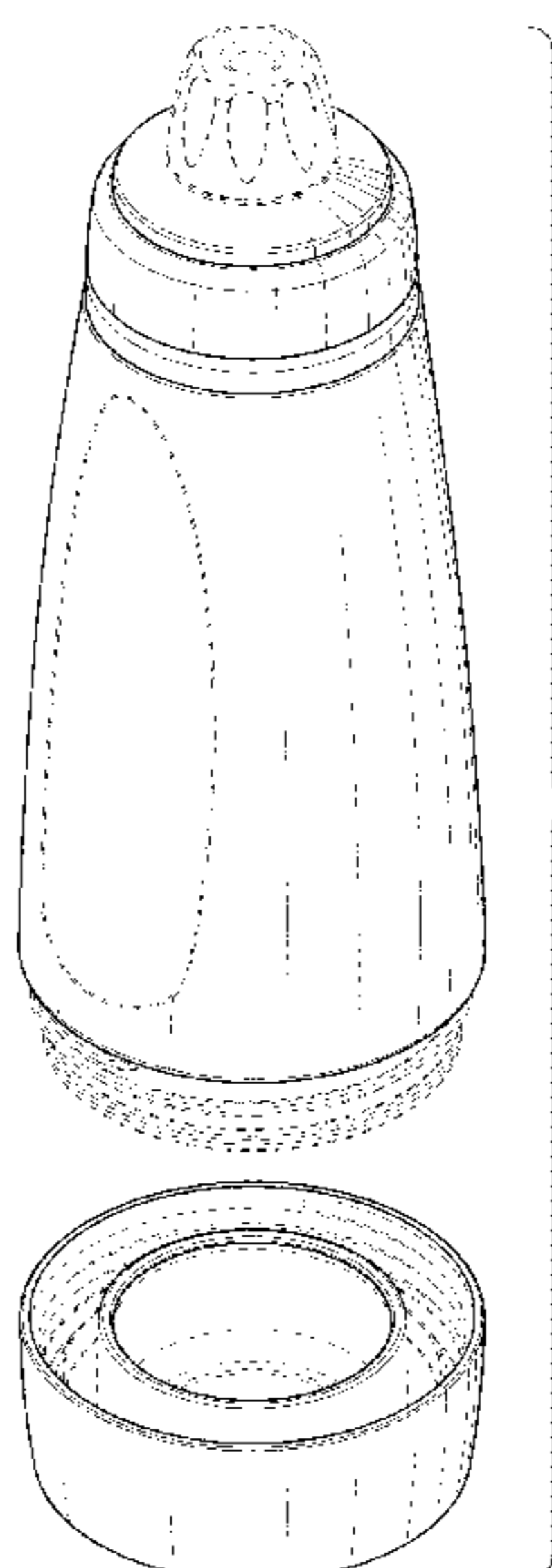

(56)

**References Cited**

U.S. PATENT DOCUMENTS

2013/0206762 A1\* 8/2013 Smith ..... B65D 1/0223  
220/214

OTHER PUBLICATIONS

Notice of Allowance from Japanese Patent Application No. 2016-005242 dated Sep. 30, 2016 (with English translation).

\* cited by examiner

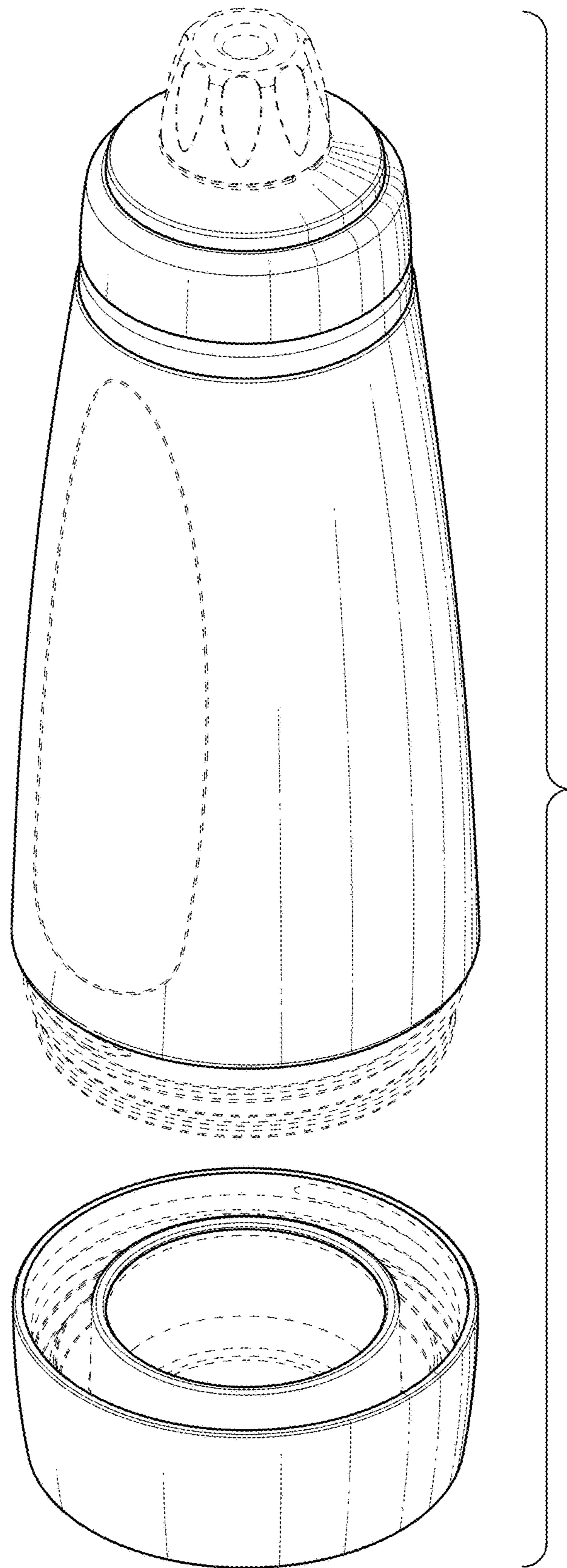

**Fig. 1**

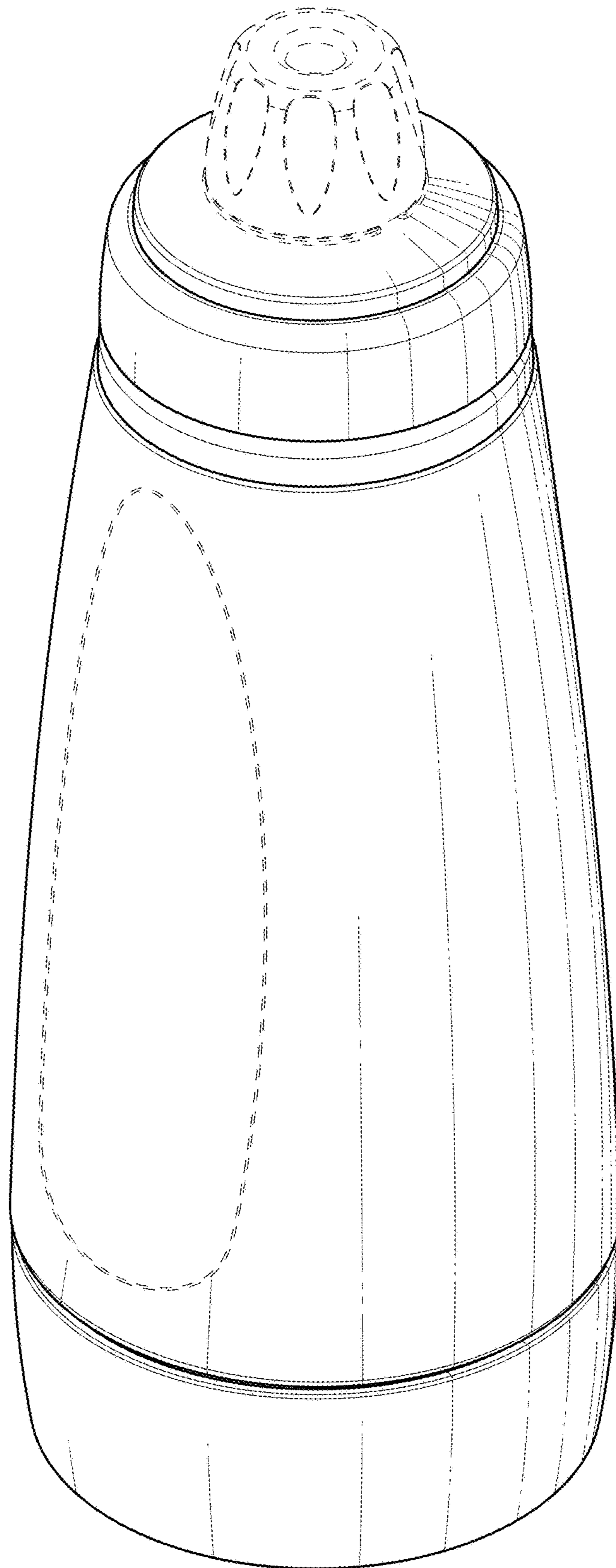

**Fig. 2**

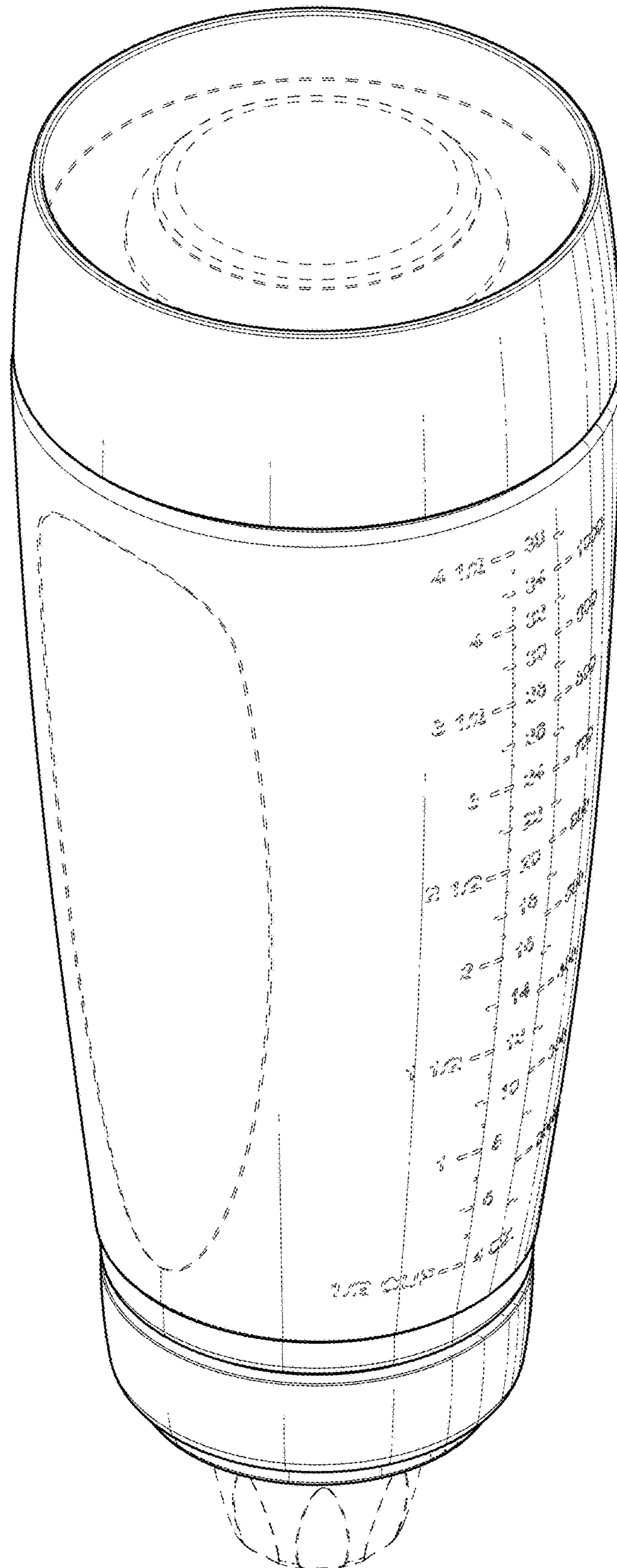

Fig. 3

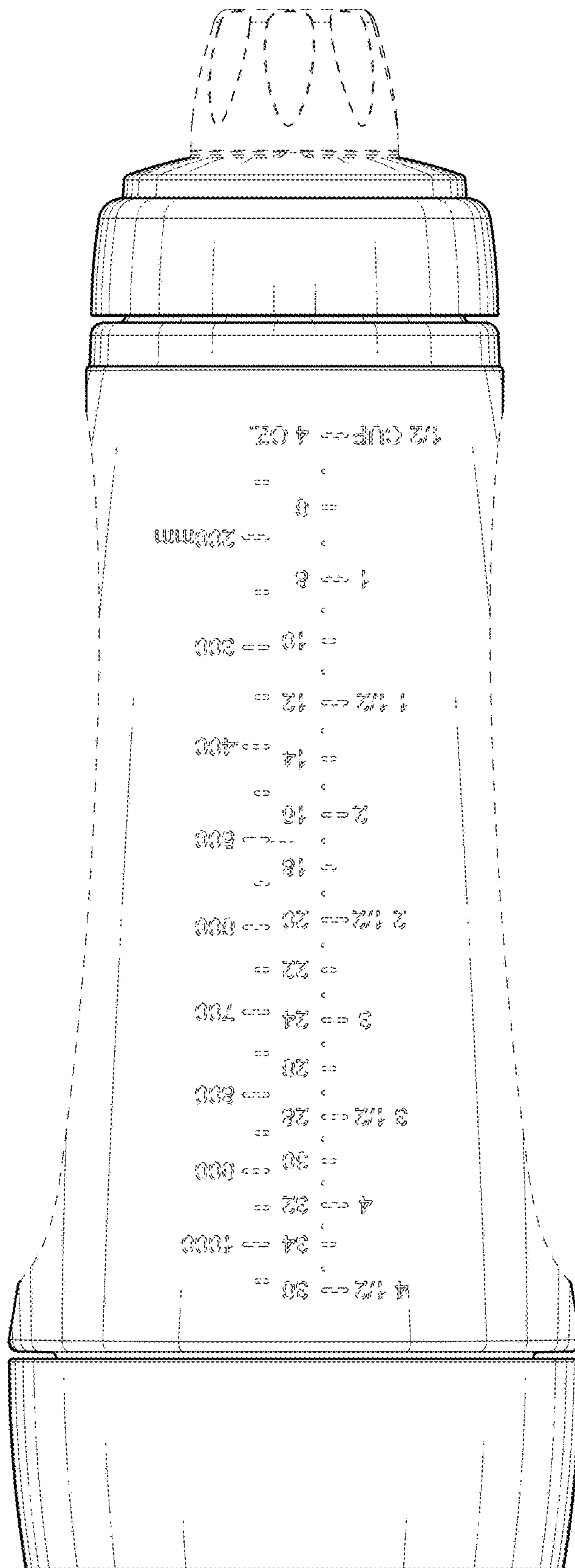
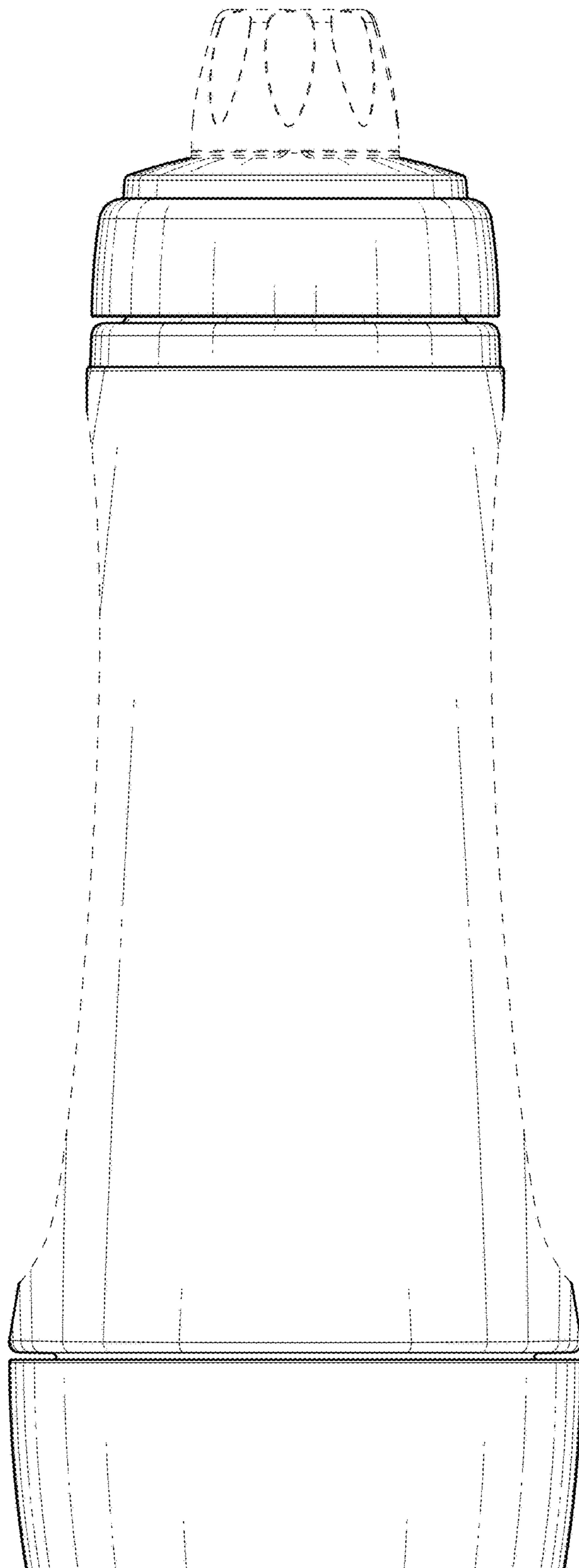
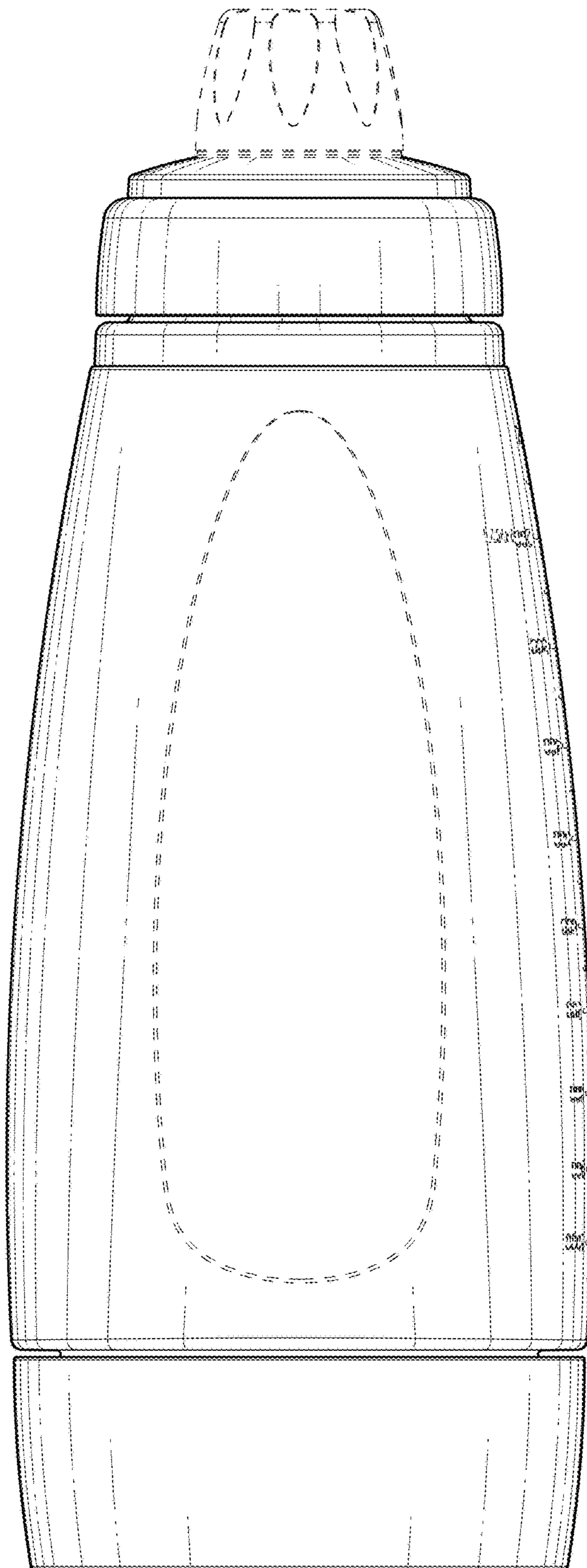

Fig. 4

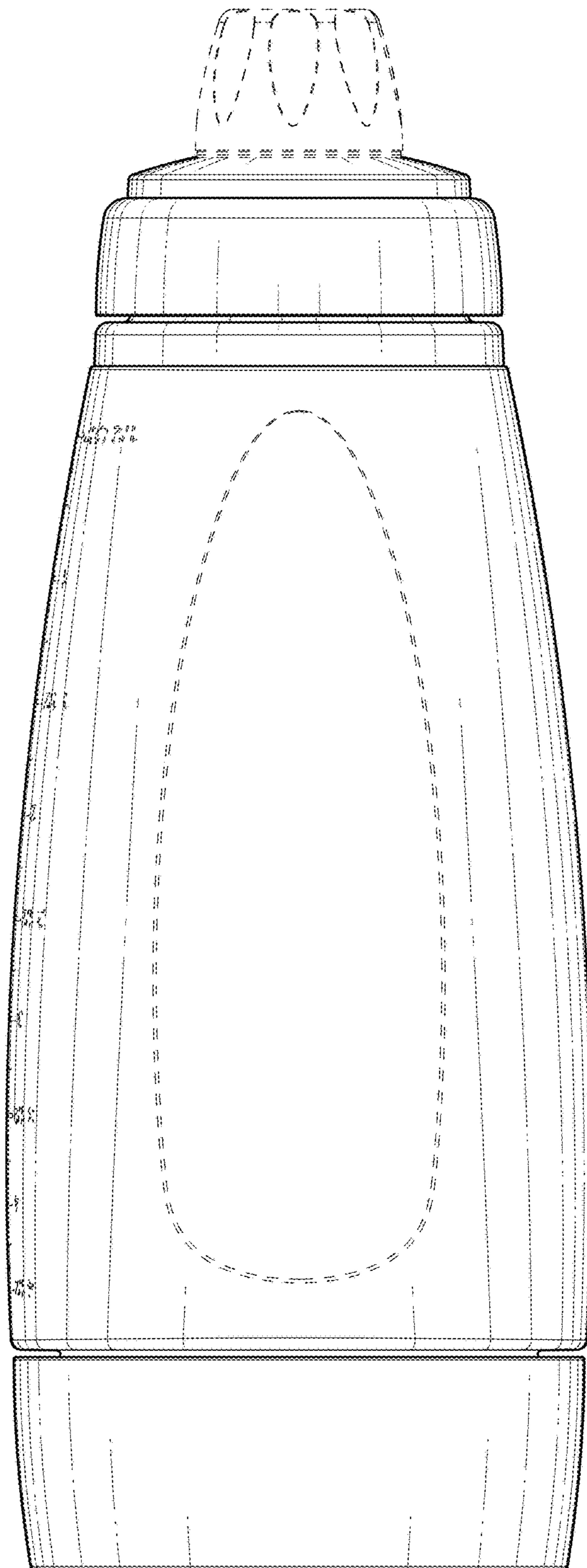

**Fig. 5**

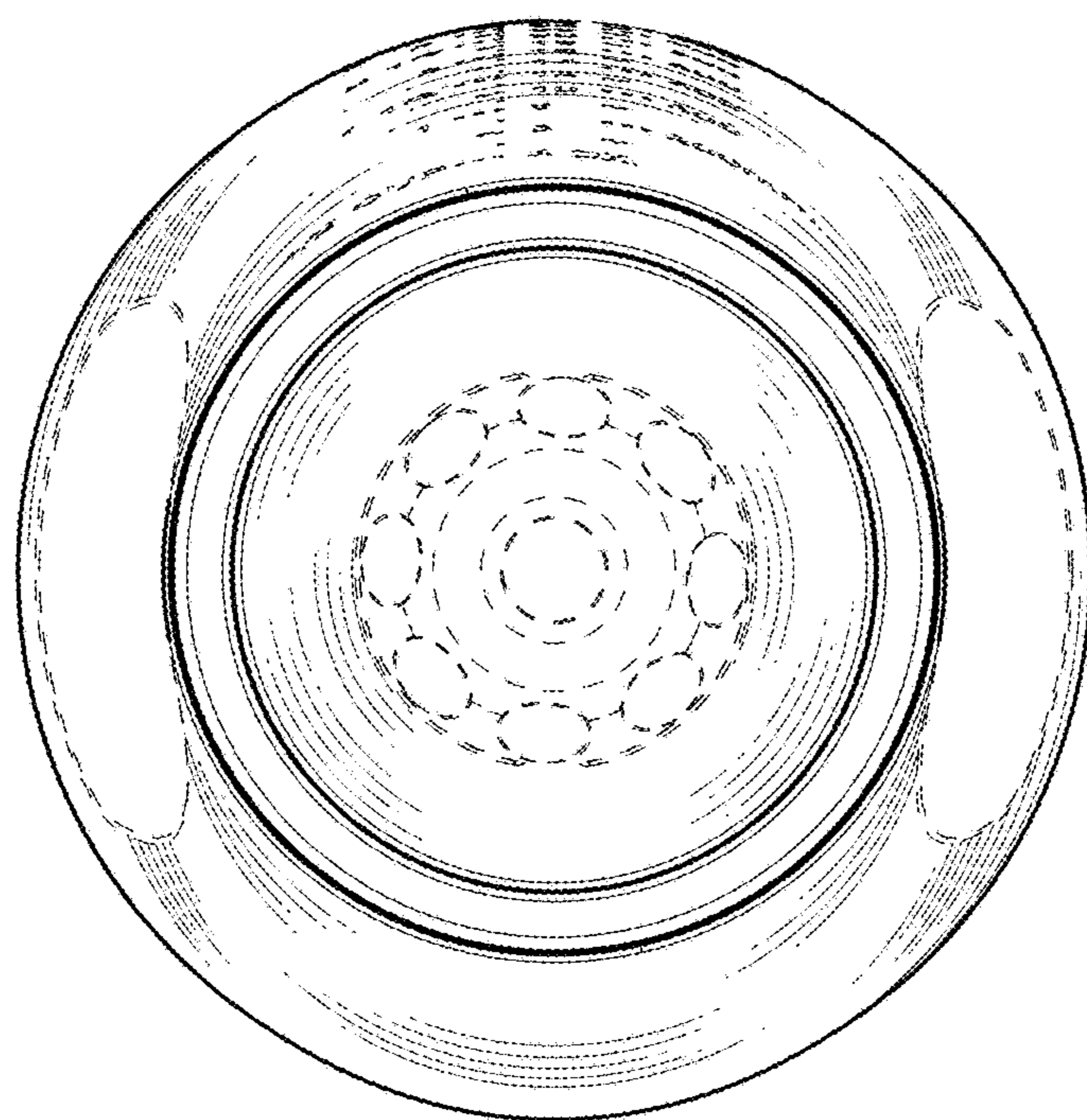

**Fig. 6**

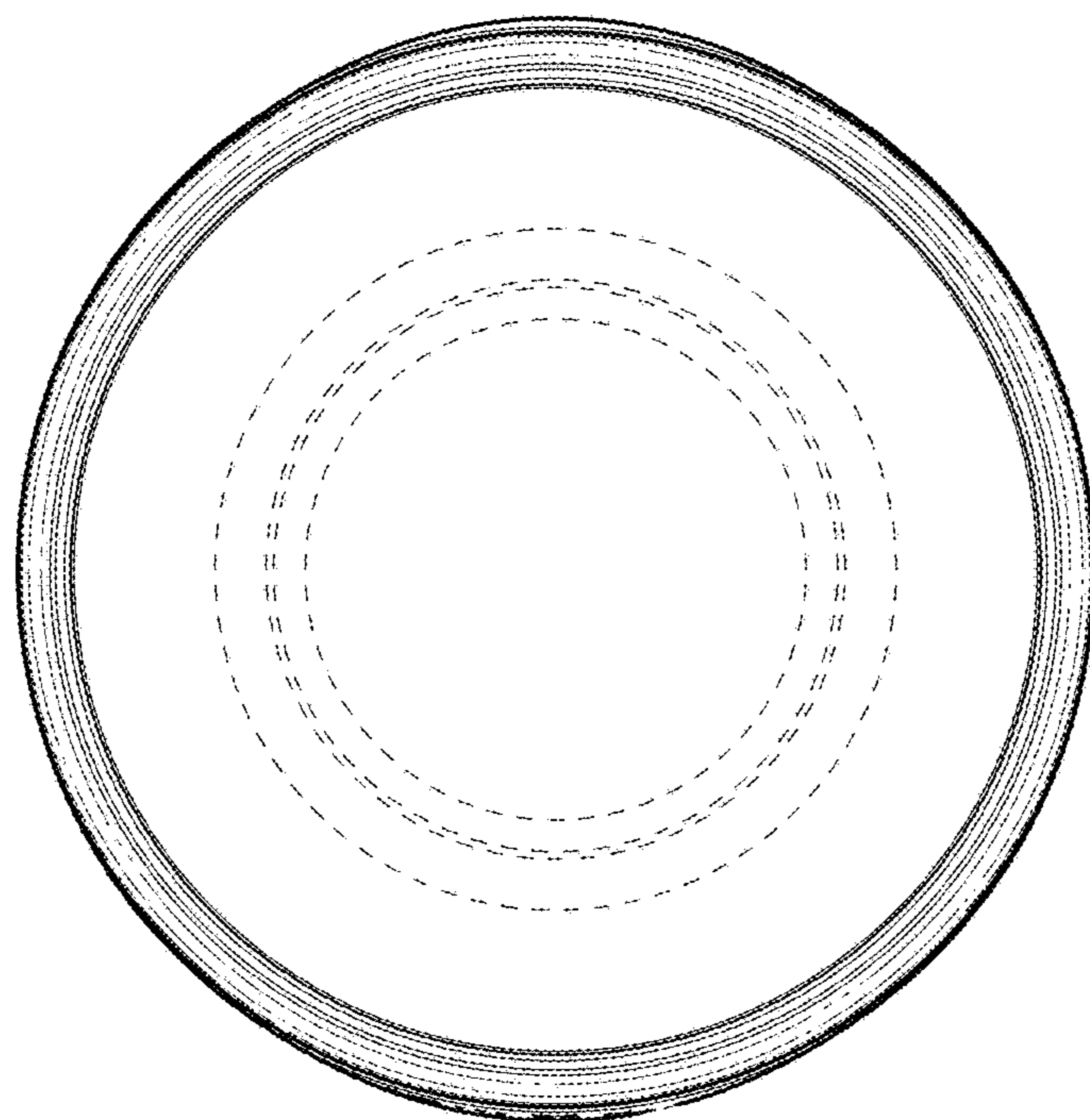



**Fig. 7**



**Fig. 8**



**Fig. 9**

UNITED STATES PATENT AND TRADEMARK OFFICE  
**CERTIFICATE OF CORRECTION**

PATENT NO. : D799,973 S  
APPLICATION NO. : 29/539279  
DATED : October 17, 2017  
INVENTOR(S) : Sorensen et al.

Page 1 of 1

It is certified that error appears in the above-identified patent and that said Letters Patent is hereby corrected as shown below:

On the Title Page

Item (72) Inventors, Line 2, delete "Apline" and insert -- Alpine --, therefor.

Signed and Sealed this  
Ninth Day of January, 2018

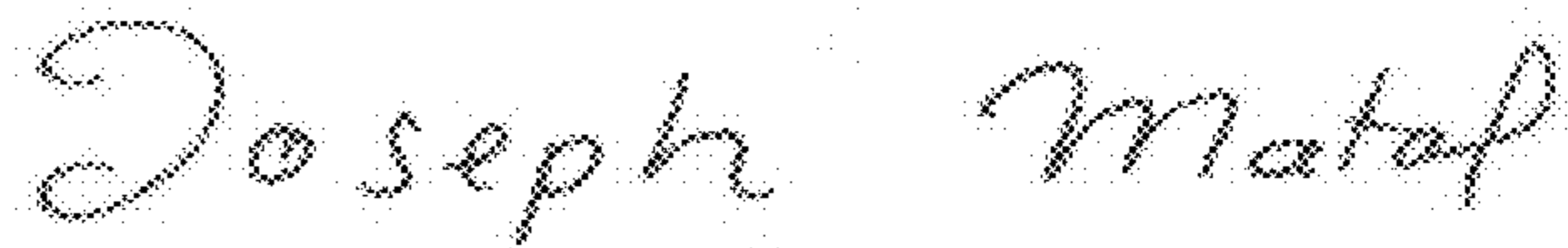

Joseph Matal

*Performing the Functions and Duties of the  
Under Secretary of Commerce for Intellectual Property and  
Director of the United States Patent and Trademark Office*