



US00D799956S

(12) **United States Design Patent** (10) **Patent No.:** **US D799,956 S**
Karmi et al. (45) **Date of Patent:** **** Oct. 17, 2017**

(54) **RETAIL-DISPLAYABLE COSMETICS PACKAGE**

(71) Applicant: **Agora, LLC**, Las Vegas, NV (US)

(72) Inventors: **Moshe Karmi**, Las Vegas, NV (US);
Amit Elfaci, Las Vegas, NV (US)

(73) Assignee: **Agora, LLC**, Las Vegas, NV (US)

(**) Term: **15 Years**

(21) Appl. No.: **29/560,270**

(22) Filed: **Apr. 5, 2016**

(51) **LOC (10) Cl.** **09-03**

(52) **U.S. Cl.**
USPC **D9/420**

(58) **Field of Classification Search**
USPC D9/420, 711, 416, 418, 504, 500, 436,
D9/428, 733, 424, 715, 721, 757, 714,
(Continued)

(56) **References Cited**

U.S. PATENT DOCUMENTS

D125,152 S * 2/1941 Hahn 206/766
2,831,948 A * 4/1958 Fraser H02B 1/048
174/110 R

(Continued)

Primary Examiner — Rhea Shields

(74) *Attorney, Agent, or Firm* — Lance M Pritikin

(57) **CLAIM**

The ornamental design for a retail-displayable cosmetics package, as shown and described.

DESCRIPTION

FIG. 1 is a front perspective view of a first embodiment of the retail displayable cosmetics package, showing our new design in a closed configuration;

FIG. 2 is front view of the retail-displayable cosmetics package in FIG. 1;

FIG. 3 is a rear view thereof;

FIG. 4 is a right side view thereof;

FIG. 5 is a left side view thereof;

FIG. 6 is a top view thereof;

FIG. 7 is a bottom view thereof;

FIG. 8 is a front perspective view of the retail-displayable cosmetics package, showing our new design in open configuration;

FIG. 9 is a front view of the retail-displayable cosmetics package in FIG. 8;

FIG. 10 is a rear view thereof;

FIG. 11 is a right side view thereof;

FIG. 12 is a left side view thereof;

FIG. 13 is top view thereof;

FIG. 14 is a bottom view thereof;

FIG. 15 is a front perspective view of a second embodiment of the retail displayable cosmetics package, showing our new design in a closed configuration;

FIG. 16 is front view of the retail-displayable cosmetics package in FIG. 15;

FIG. 17 is a rear view thereof;

FIG. 18 is a right side view thereof;

FIG. 19 is a left side view thereof;

FIG. 20 is a top view thereof;

FIG. 21 is a bottom view thereof;

FIG. 22 is a front perspective view of the further embodiment of a retail-displayable cosmetics package, showing our new design in open configuration;

FIG. 23 is a front view thereof;

FIG. 24 is a rear view thereof;

FIG. 25 is a right side view thereof;

FIG. 26 is a left side view thereof;

FIG. 27 is top view thereof; and,

FIG. 28 is a bottom view thereof.

In the drawings, the broken lines are for the purpose of illustrating environment only and form no part of the claimed design.

1 Claim, 18 Drawing Sheets

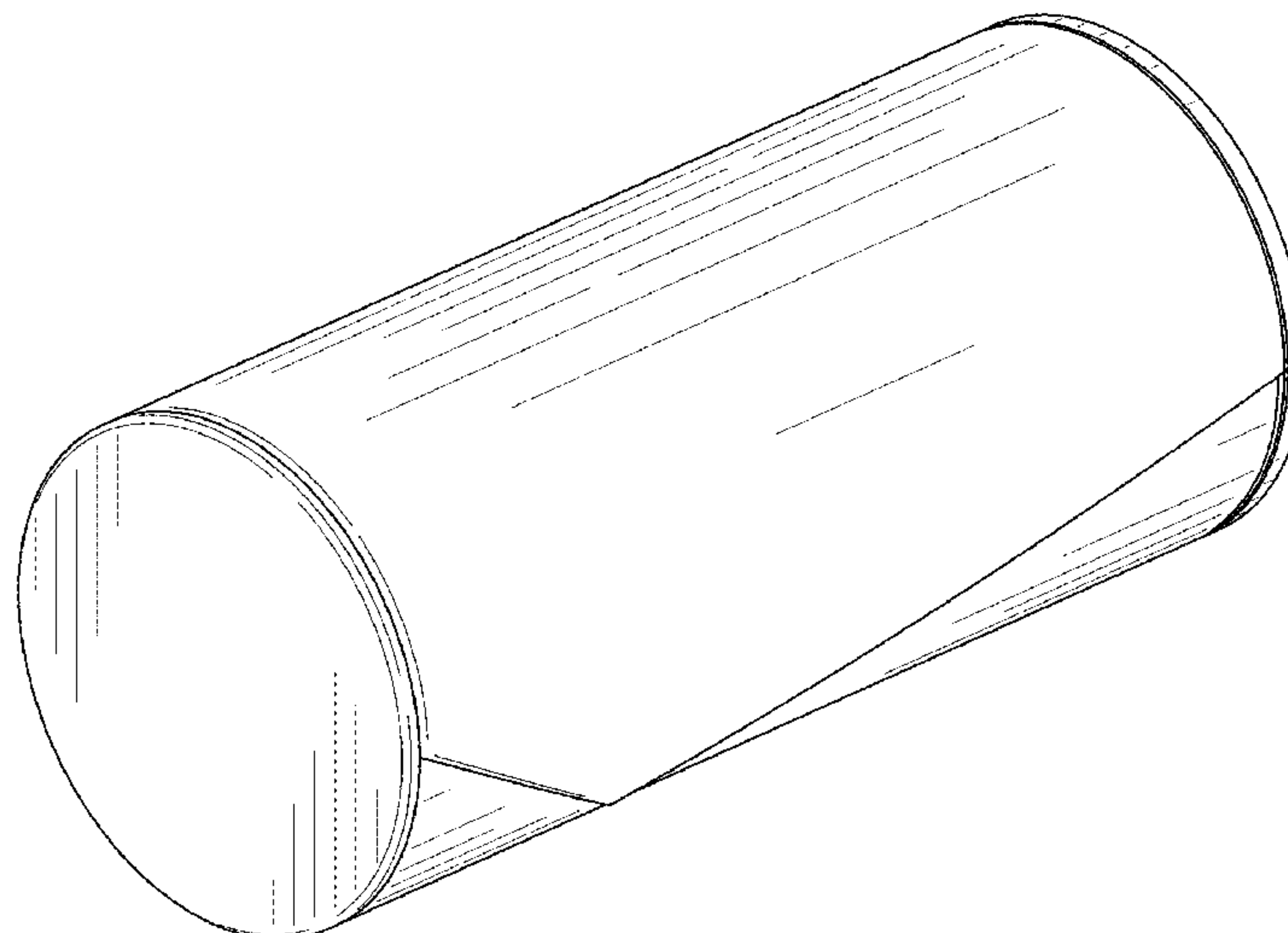

(58) **Field of Classification Search**

USPC D9/734; D7/538, 392, 523, 509;
 D11/152; D10/46.2; D22/122;
 D21/324; D28/73, 76, 4, 77; D20/8;
 D3/304, 273; 206/766; 138/141;
 174/110 R
 CPC H02B 1/048; B32B 29/00
 See application file for complete search history.

(56) **References Cited**

U.S. PATENT DOCUMENTS

D285,128 S * 8/1986 Yuen D28/77
 D314,912 S * 2/1991 Rey Pascual D9/500
 D396,631 S * 8/1998 DuGrenier D9/436
 D419,298 S * 1/2000 Bramsiepe D3/273
 D424,431 S * 5/2000 Suzuki D21/324
 D431,322 S * 9/2000 Lemoine D28/73
 D434,980 S * 12/2000 Suzuki D9/418
 D439,472 S * 3/2001 Wang D7/509
 6,309,717 B1 * 10/2001 Qiu B32B 29/00
 138/141
 D466,809 S * 12/2002 Sagel D9/428
 D469,578 S * 1/2003 Thorpe D28/4
 D469,579 S * 1/2003 Thorpe D28/76
 D509,733 S * 9/2005 Jongens D9/420
 D529,819 S * 10/2006 Jackson D9/733

D531,517 S * 11/2006 Hillard D9/715
 D542,316 S * 5/2007 Jackson D9/733
 D543,842 S * 6/2007 Jackson D9/420
 D555,473 S * 11/2007 Lilly D9/424
 D593,871 S * 6/2009 Schmidt D9/721
 D599,655 S * 9/2009 Friebe D9/420
 D636,275 S * 4/2011 Stapleton D9/757
 D654,373 S * 2/2012 Czarny D9/714
 D671,837 S * 12/2012 Rosenberg D9/416
 D672,647 S * 12/2012 Hora D9/434
 D672,661 S * 12/2012 Hora D9/734
 D675,442 S * 2/2013 Hawkins D3/304
 D685,261 S * 7/2013 Hunter D9/420
 D685,262 S * 7/2013 Hunter D9/420
 D698,641 S * 2/2014 Theisen D9/418
 D722,113 S * 2/2015 Knight D20/8
 D727,104 S * 4/2015 Ke D7/523
 D745,319 S * 12/2015 Melzer D7/392
 D756,216 S * 5/2016 El-Debs D9/420
 D763,086 S * 8/2016 Kalagher D9/504
 D764,905 S * 8/2016 Banerjee D9/420
 D774,889 S * 12/2016 Nam D9/416
 D776,228 S * 1/2017 Caruso D22/122
 D776,563 S * 1/2017 Suphachadiwong D11/152
 D778,669 S * 2/2017 Kestenbaum D10/46.2
 D786,699 S * 5/2017 Shipulin D9/711
 D790,394 S * 6/2017 Suphachadiwong D11/152
 D794,394 S * 8/2017 Karussi D7/538

* cited by examiner

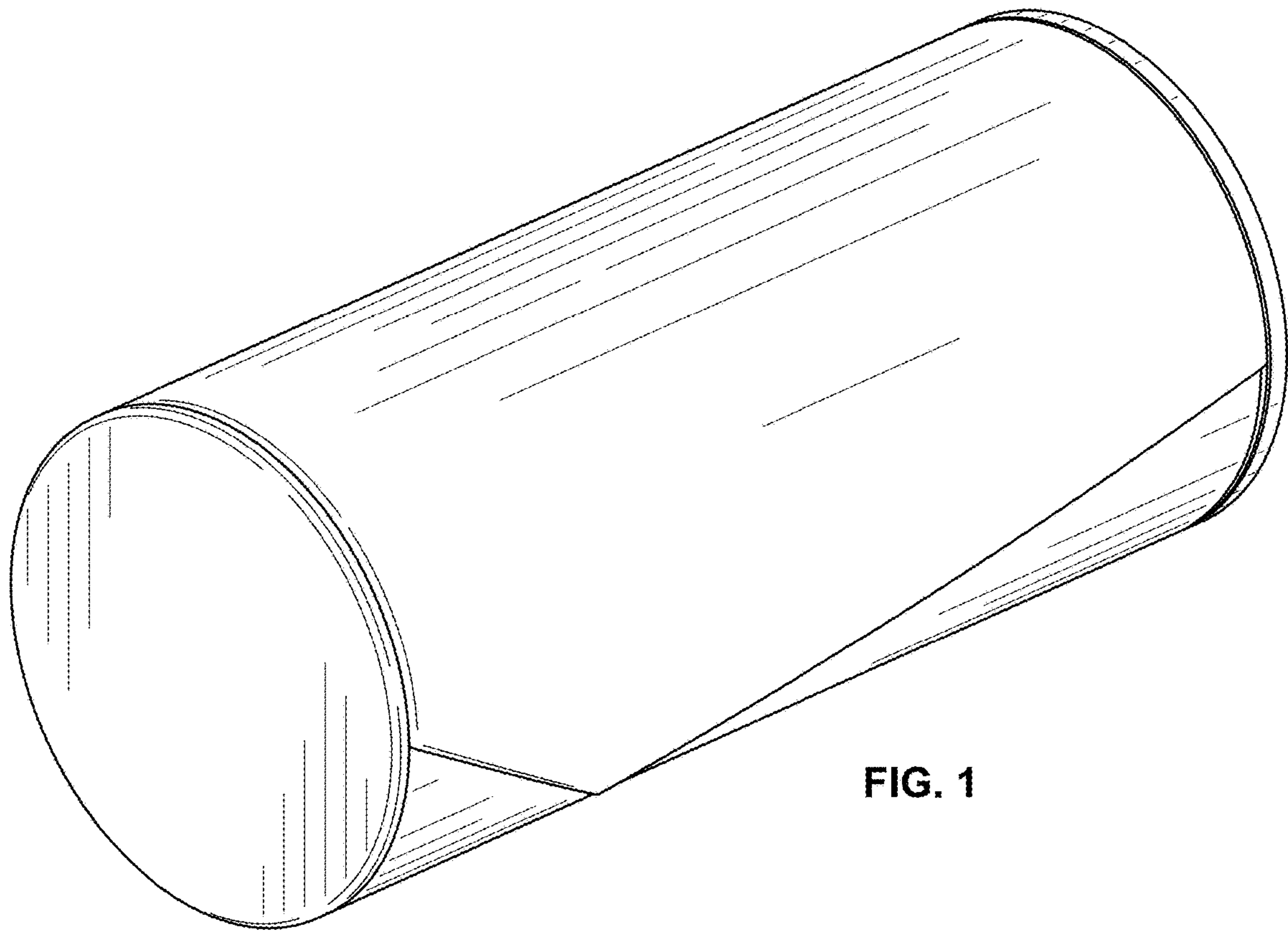

FIG. 1

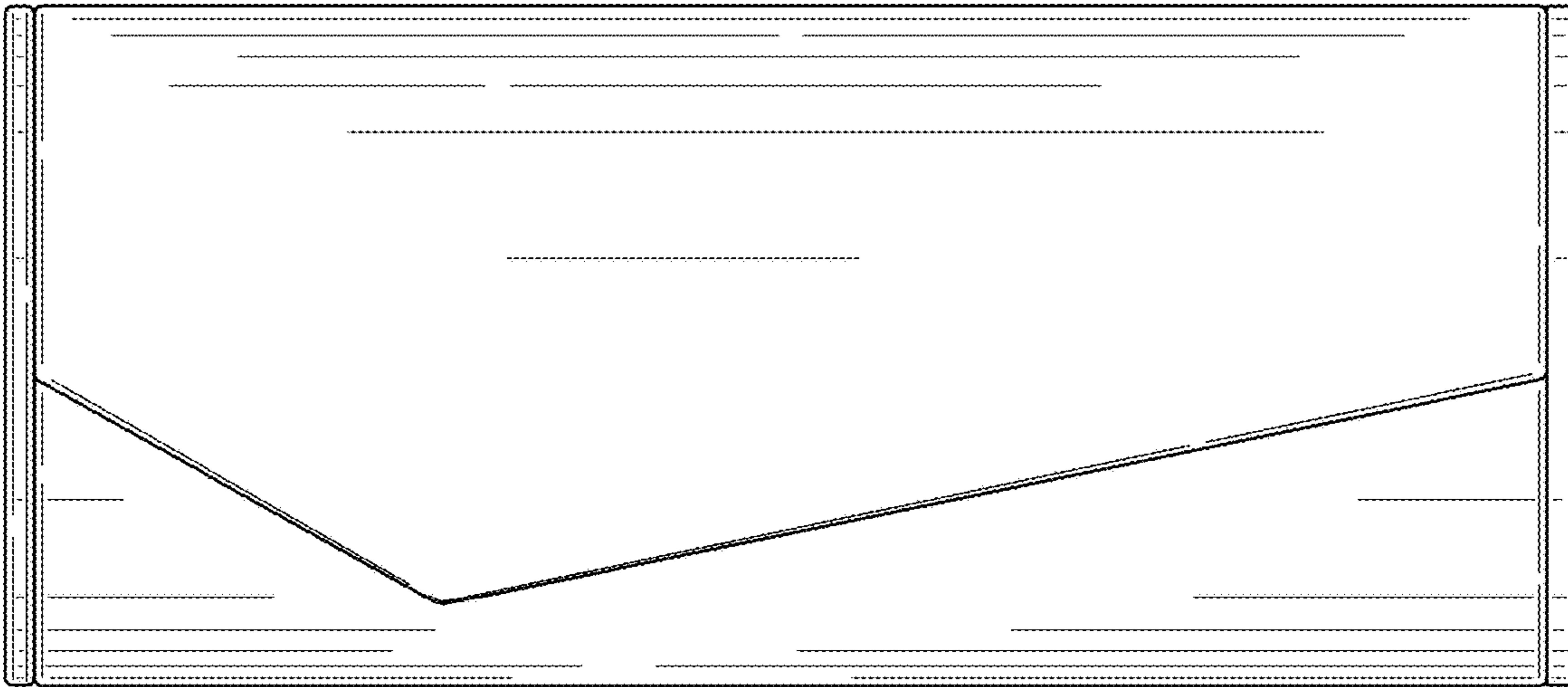

FIG. 2

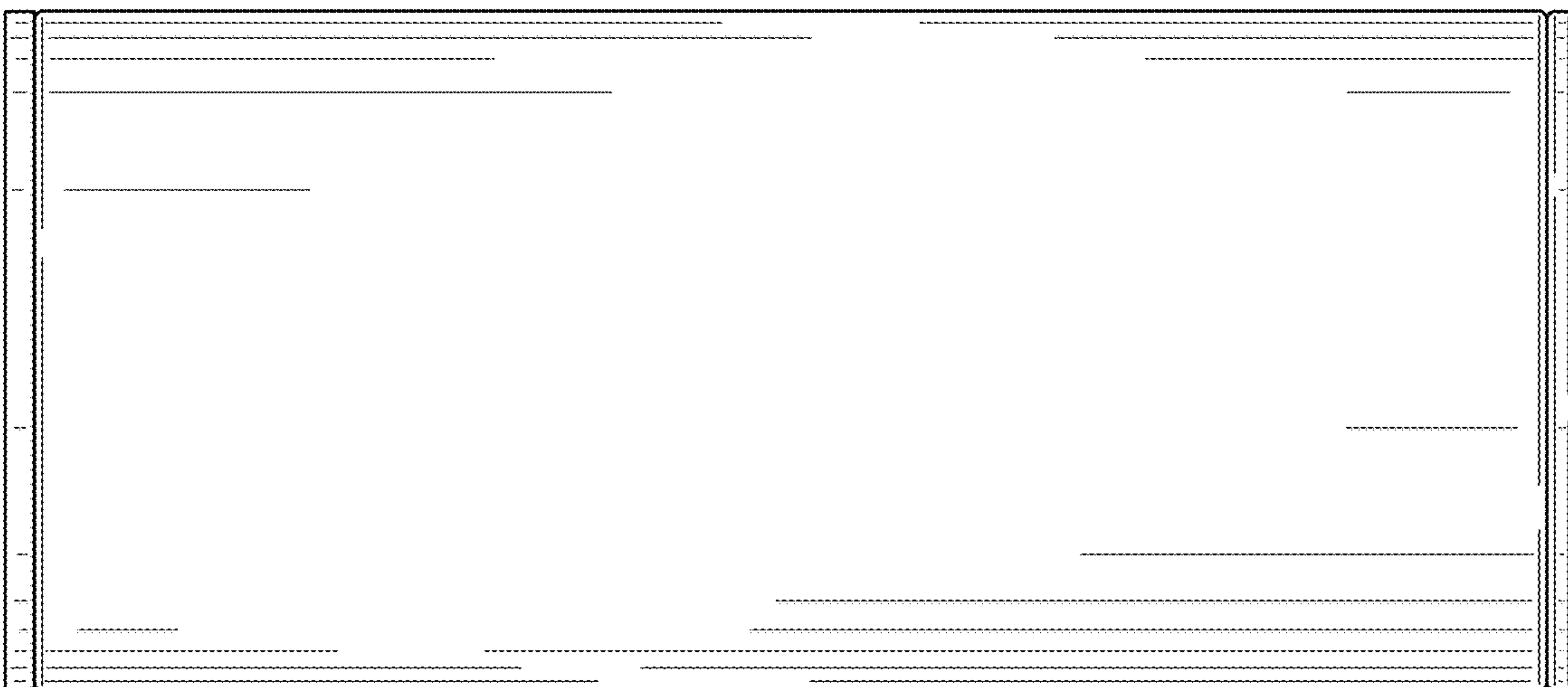

FIG. 3

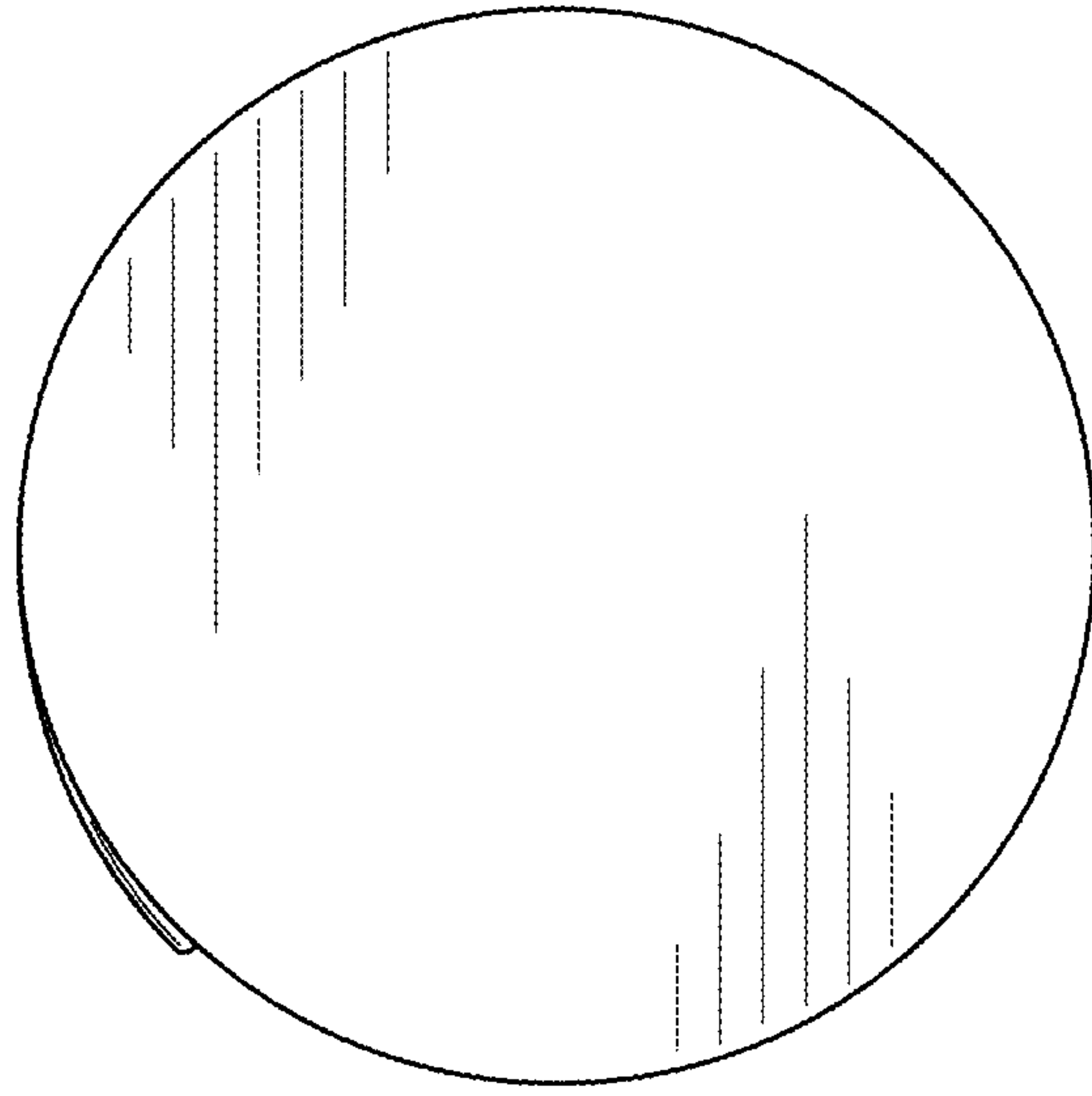

FIG. 4

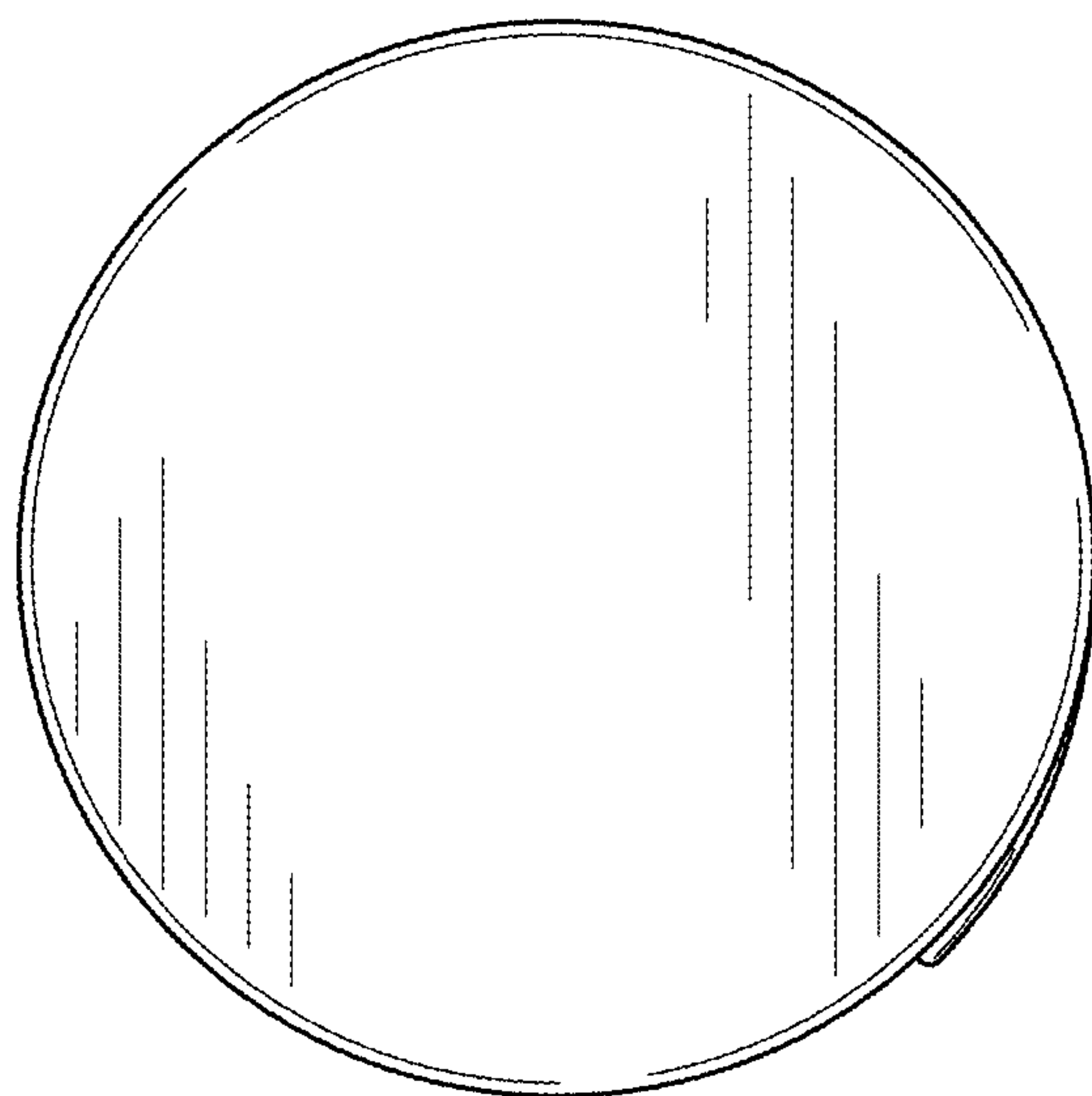

FIG. 5

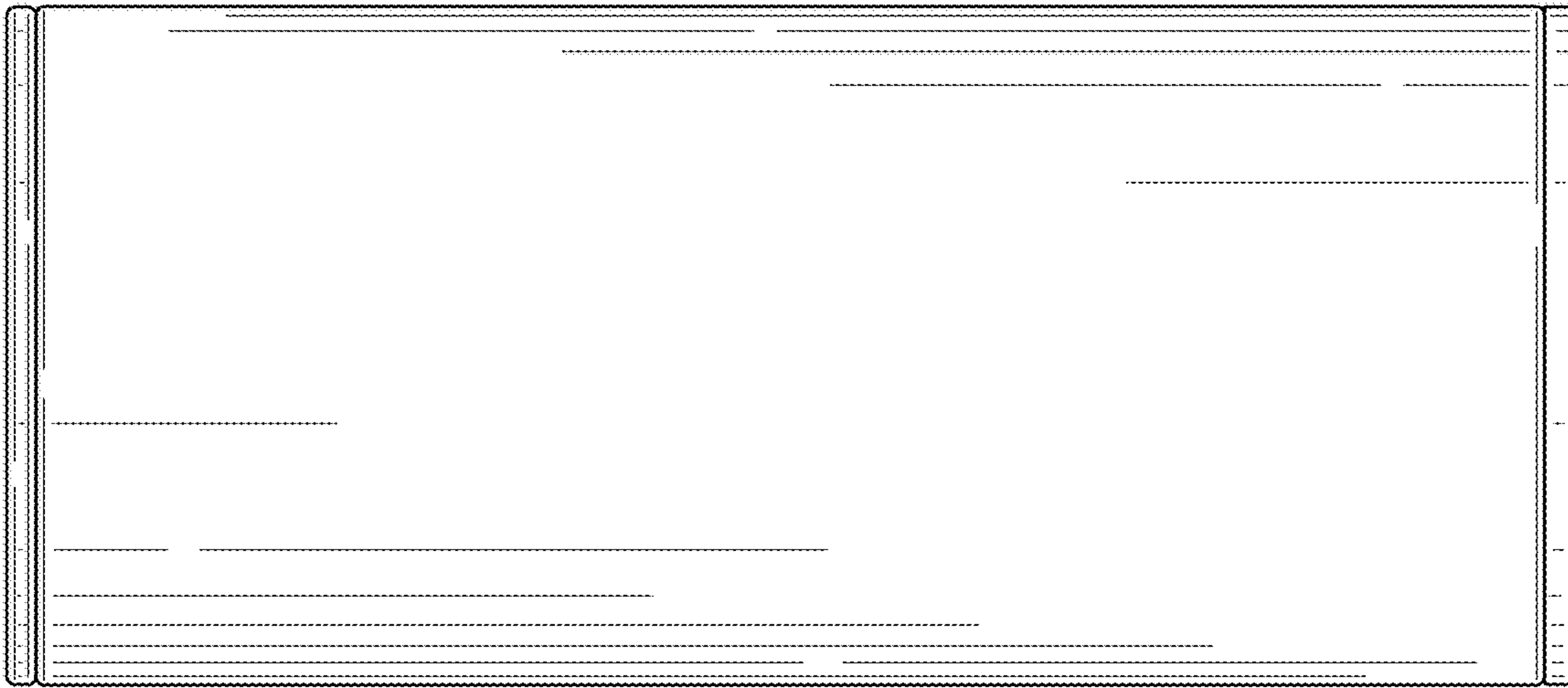

FIG. 6

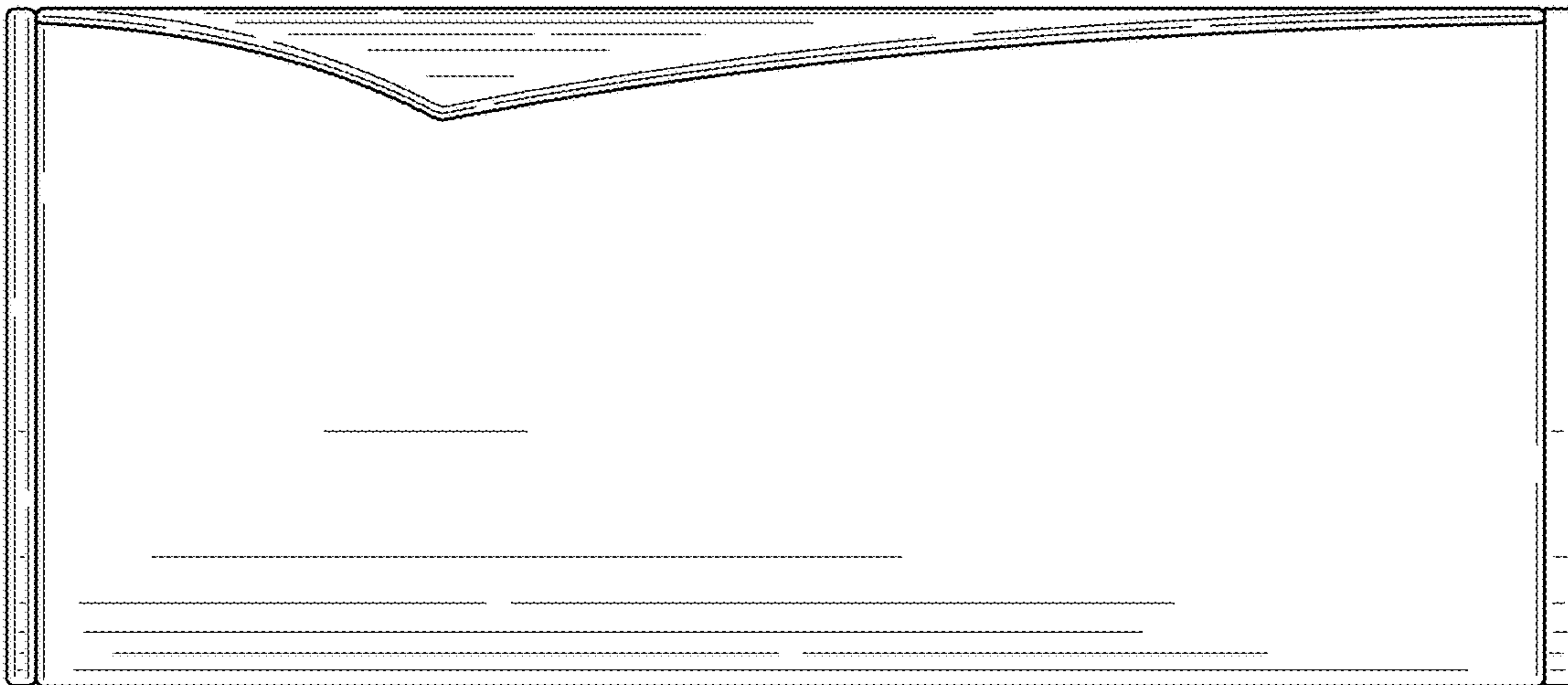

FIG. 7

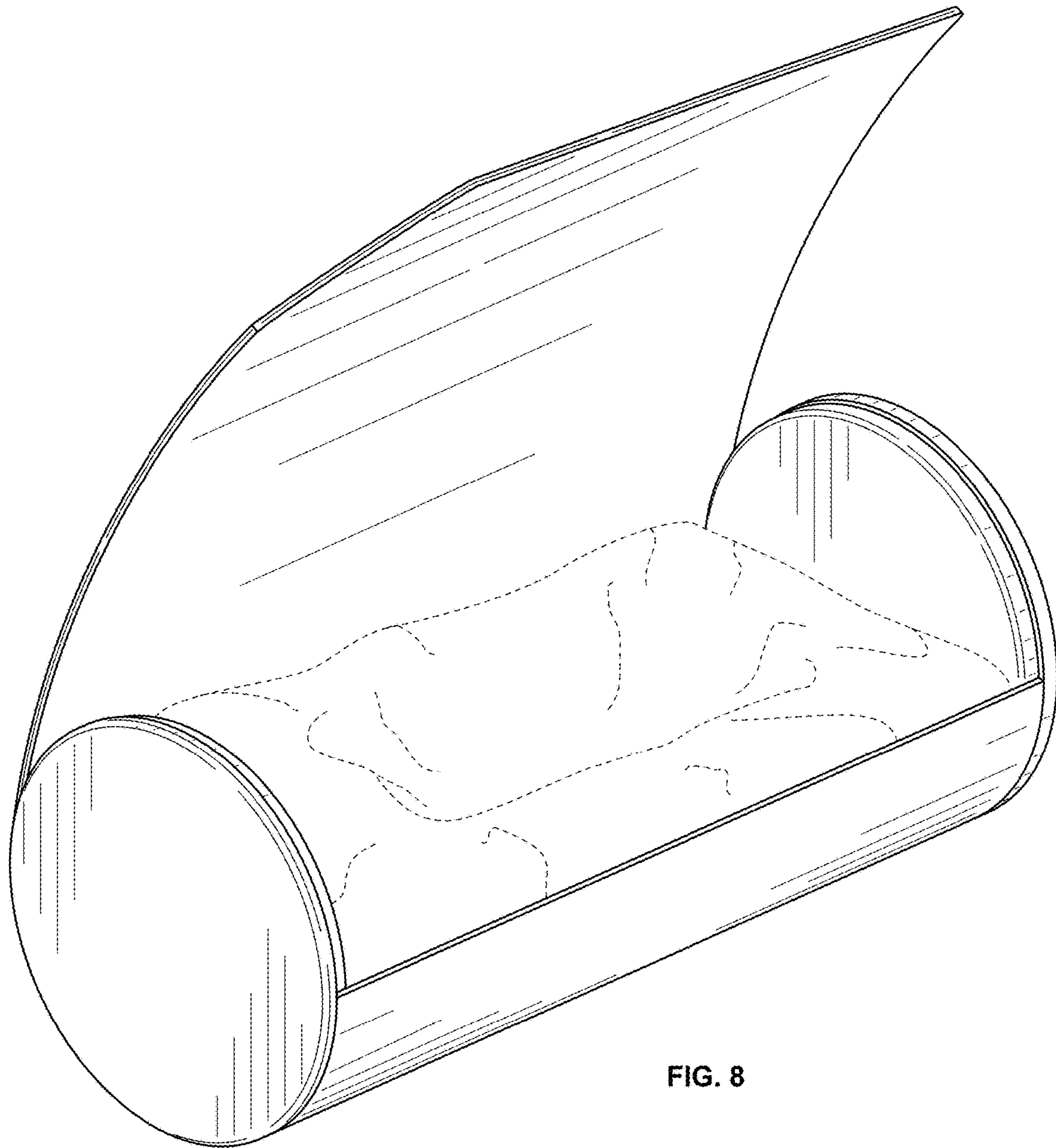

FIG. 8

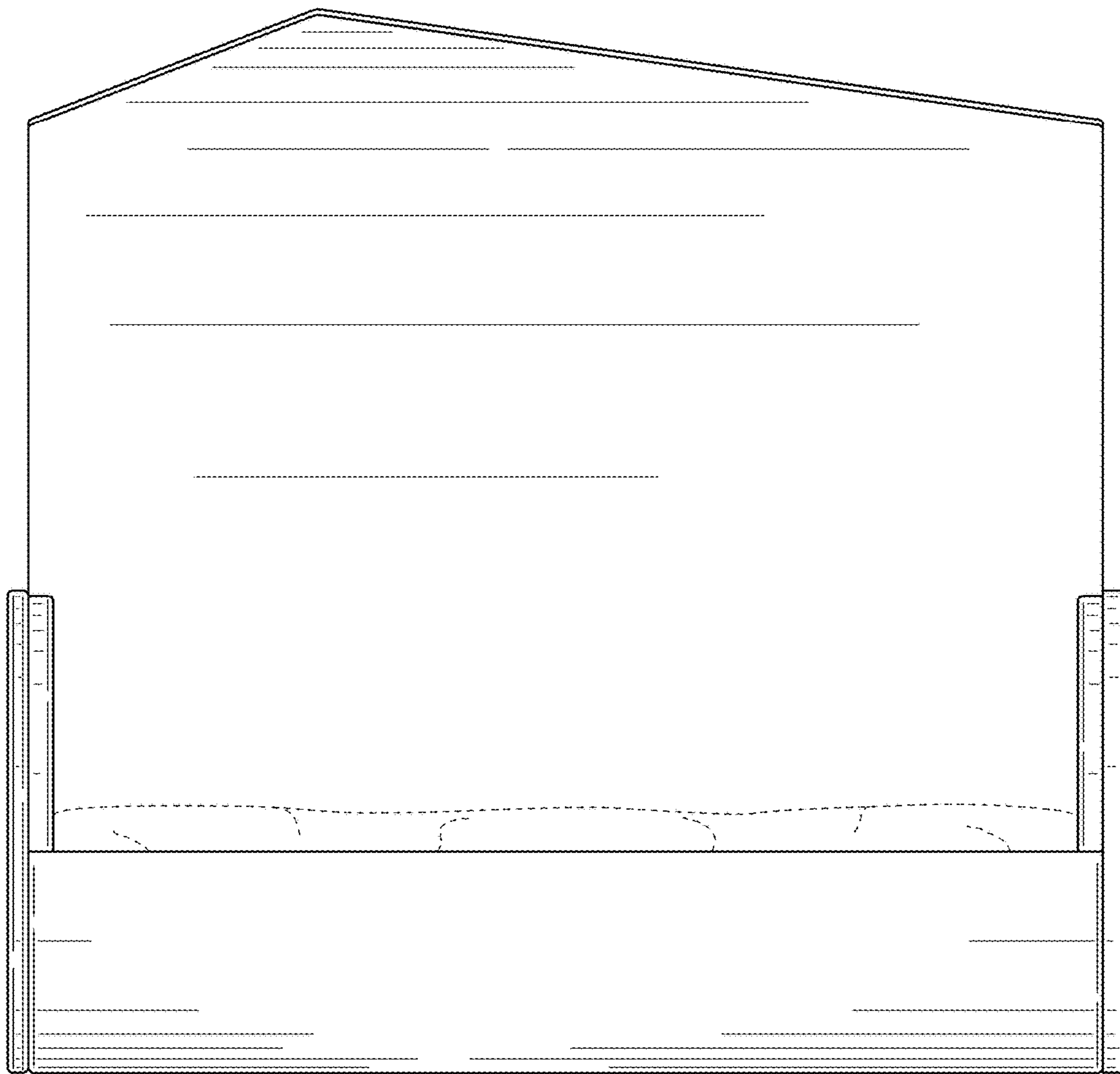

FIG. 9

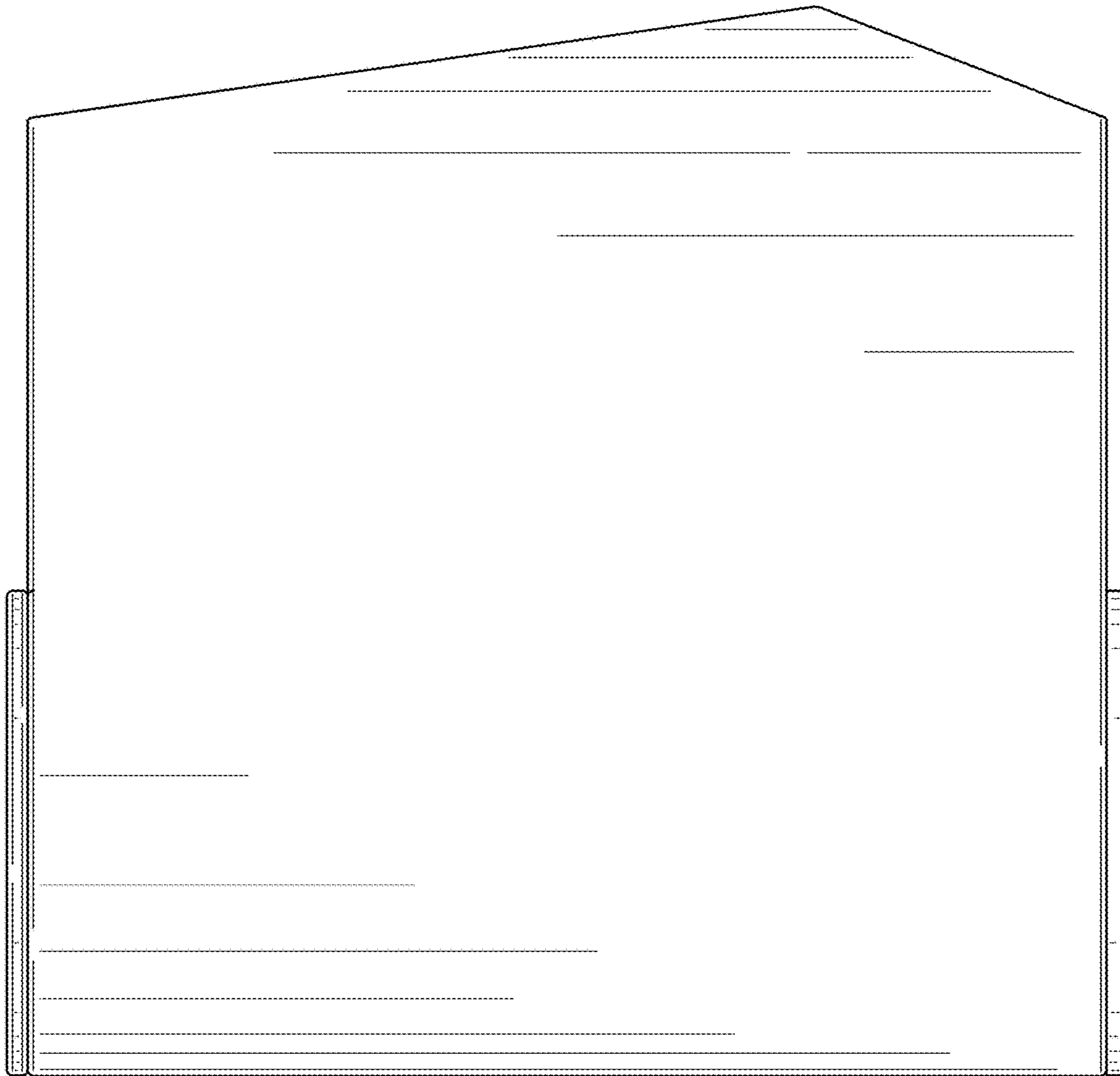

FIG. 10

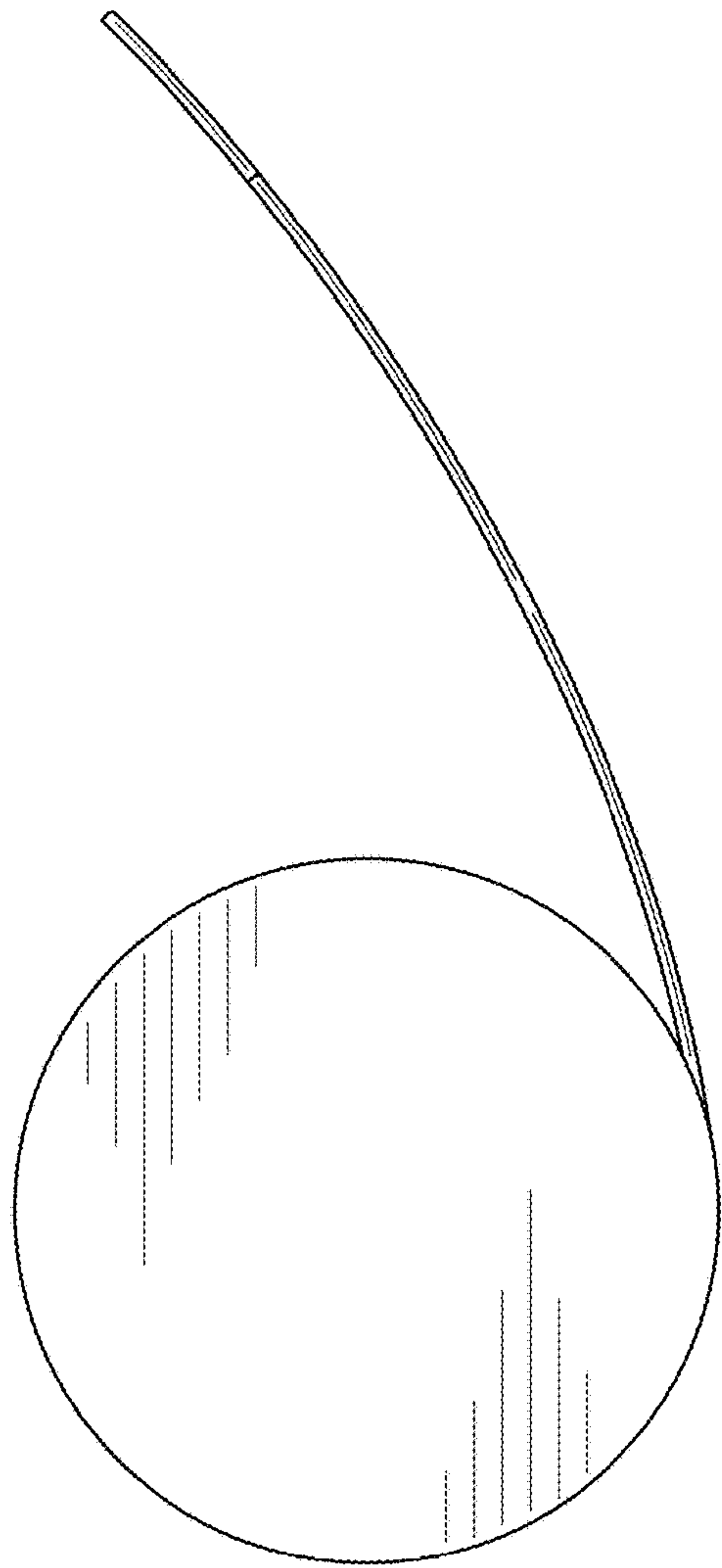

FIG. 11

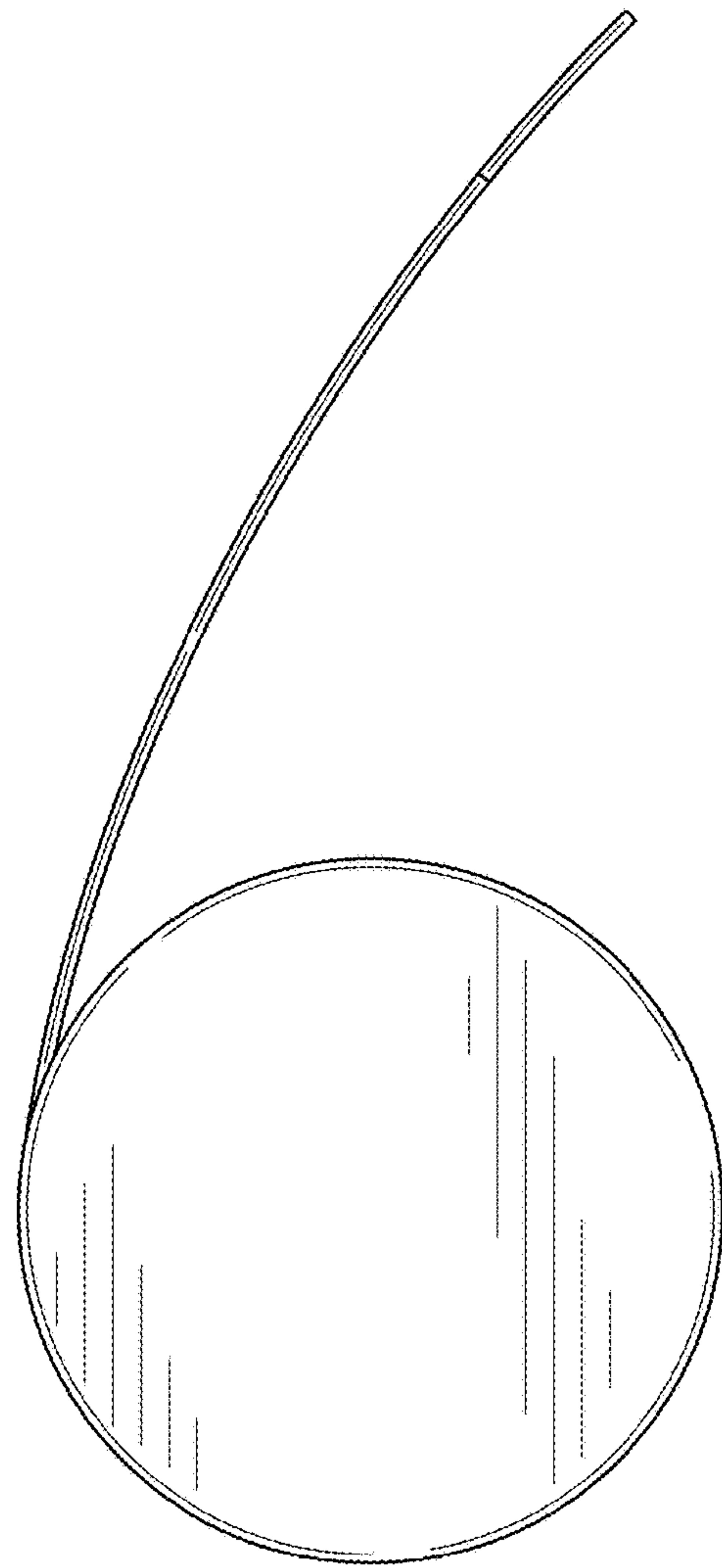

FIG. 12

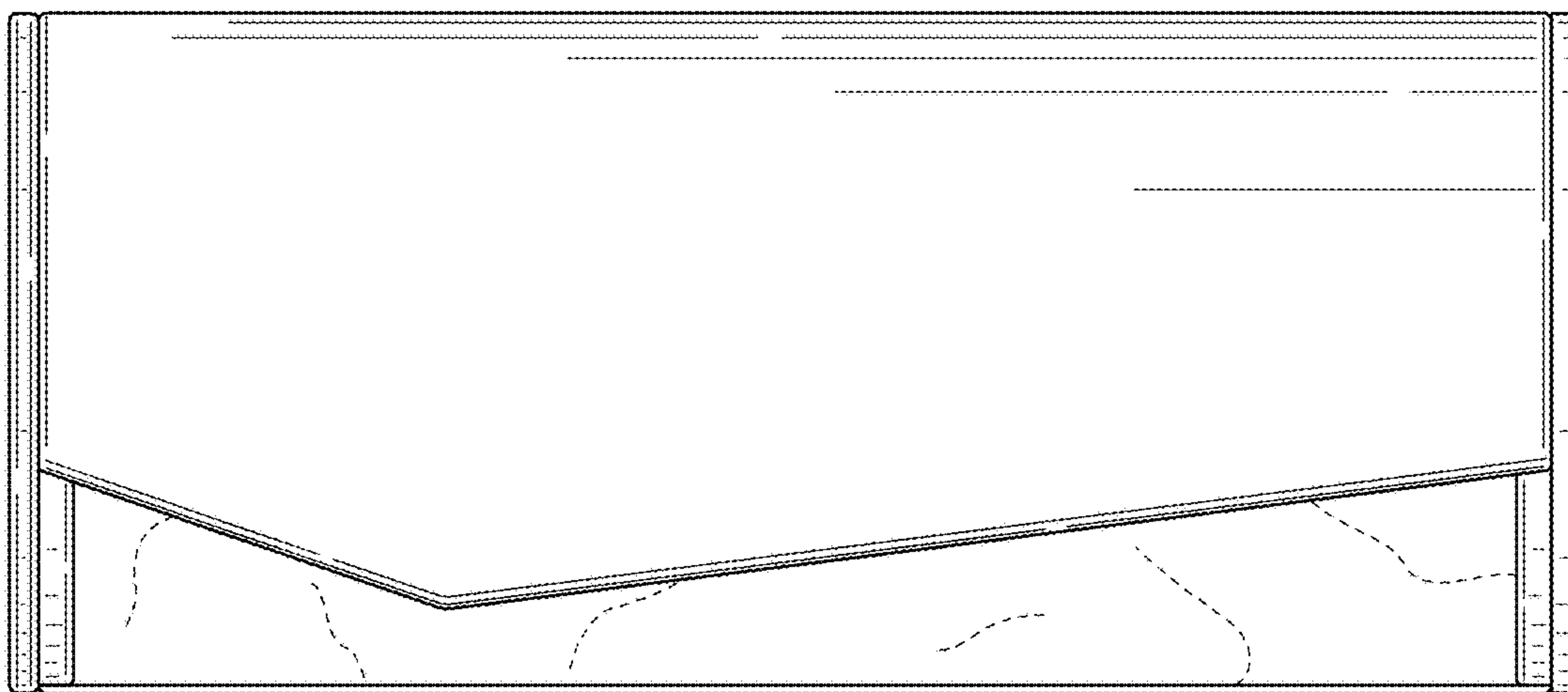

FIG. 13

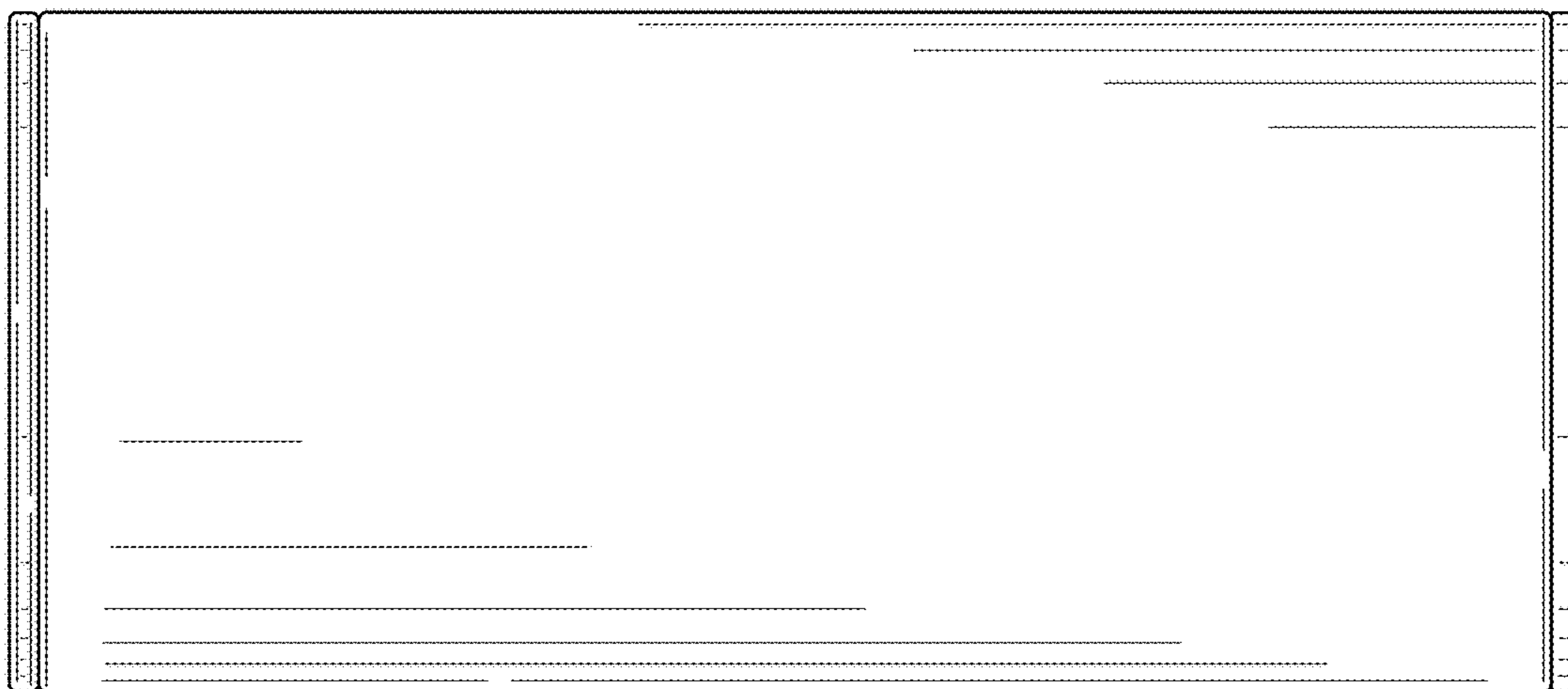

FIG. 14

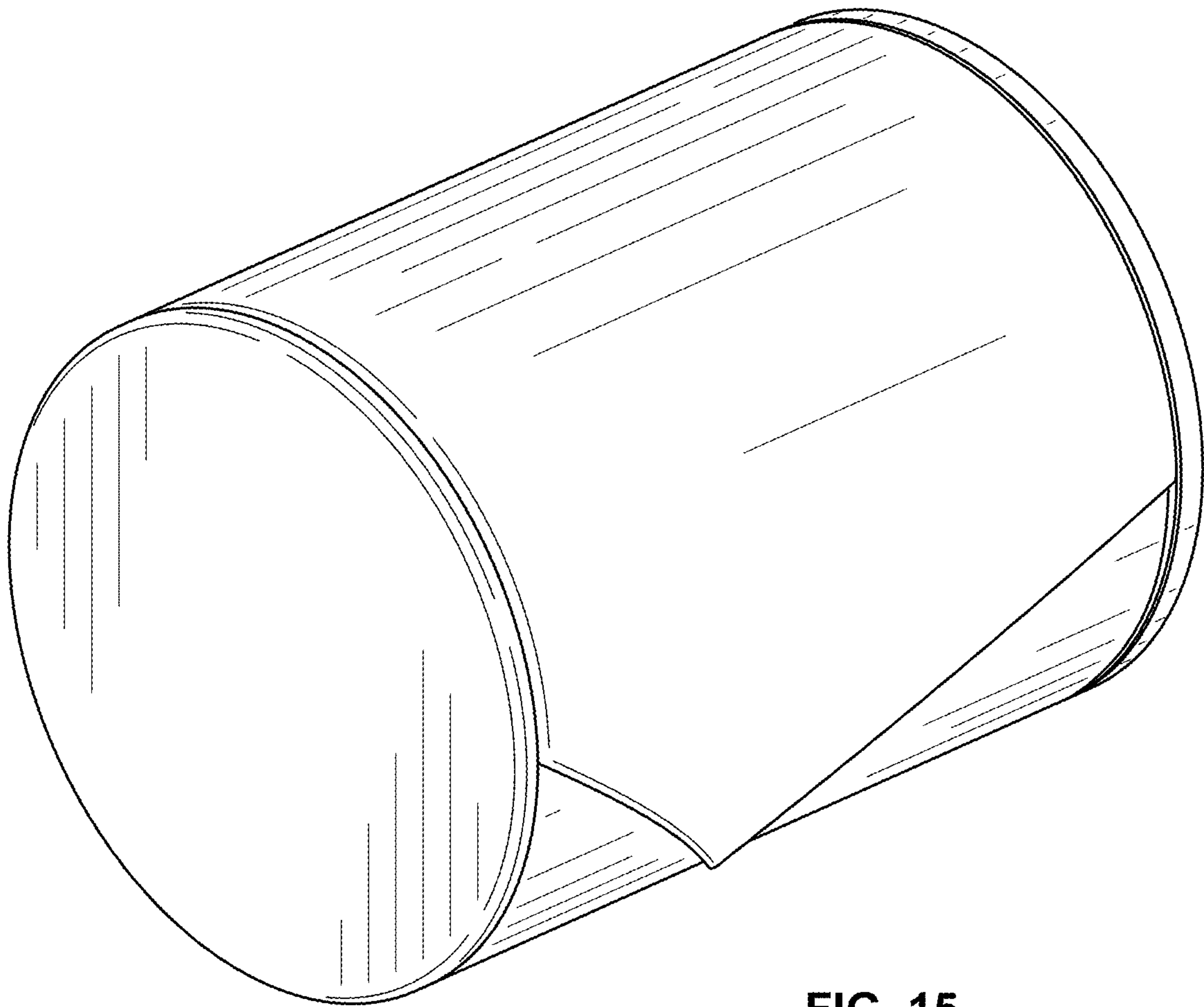

FIG. 15

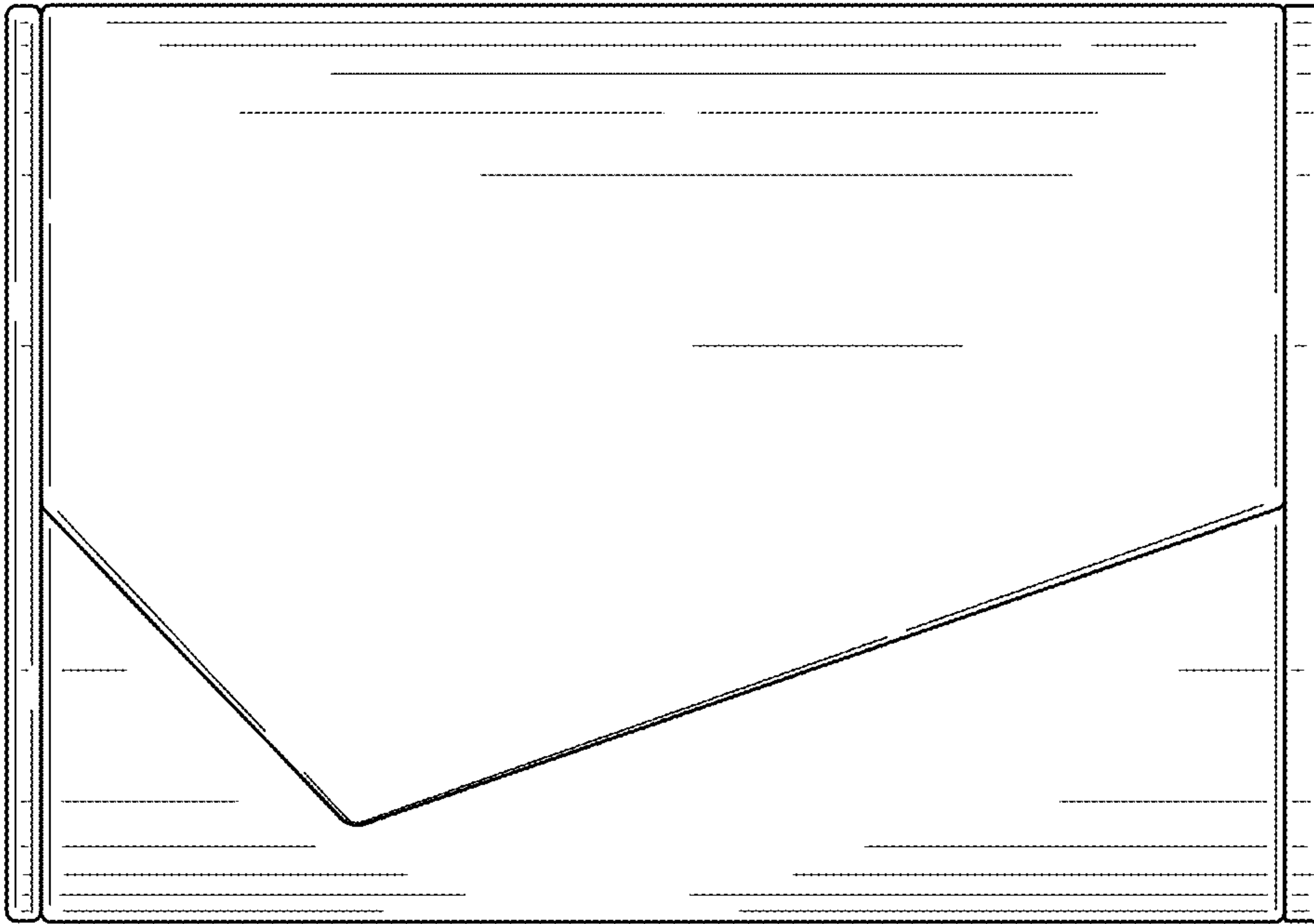

FIG. 16

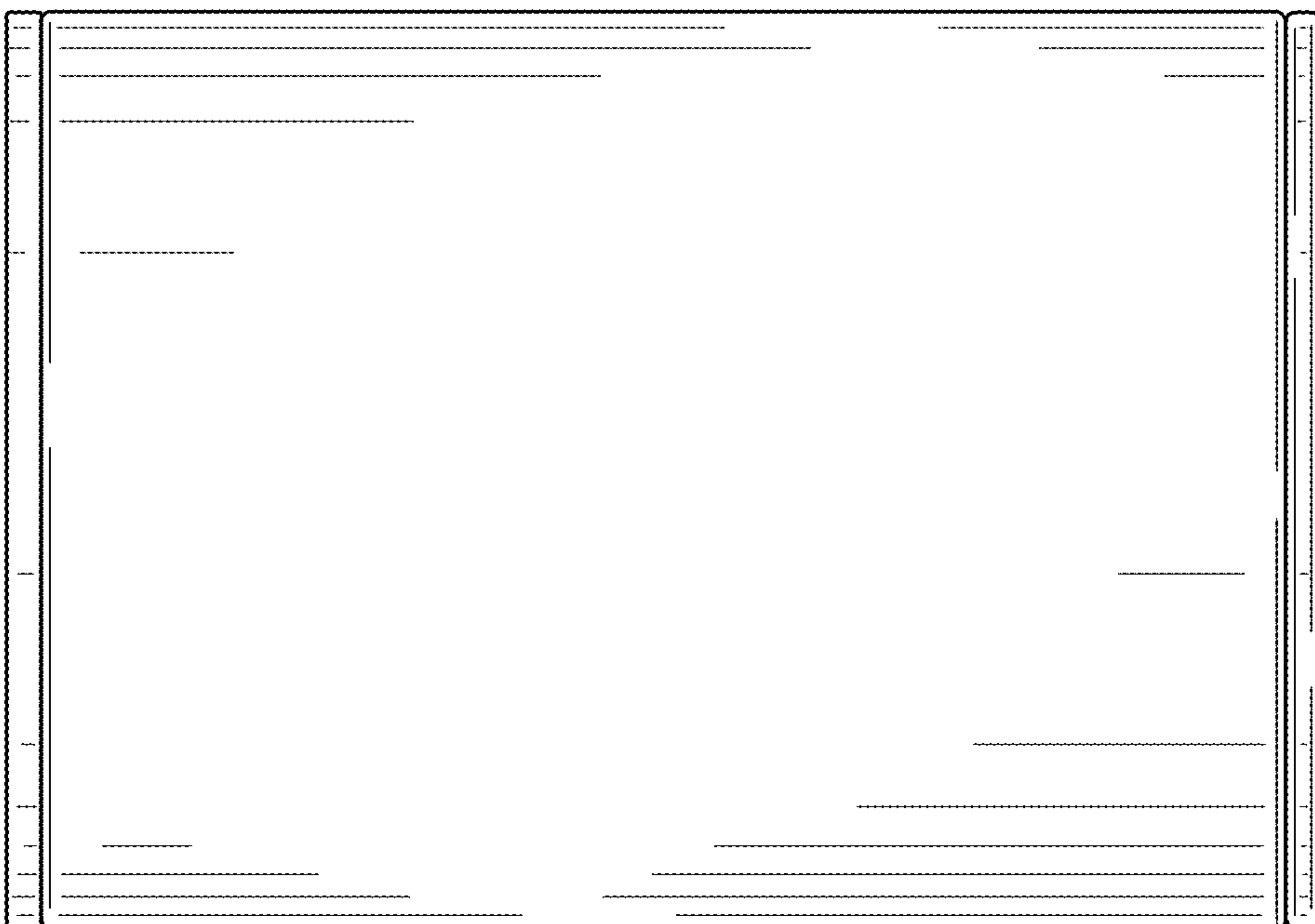

FIG. 17

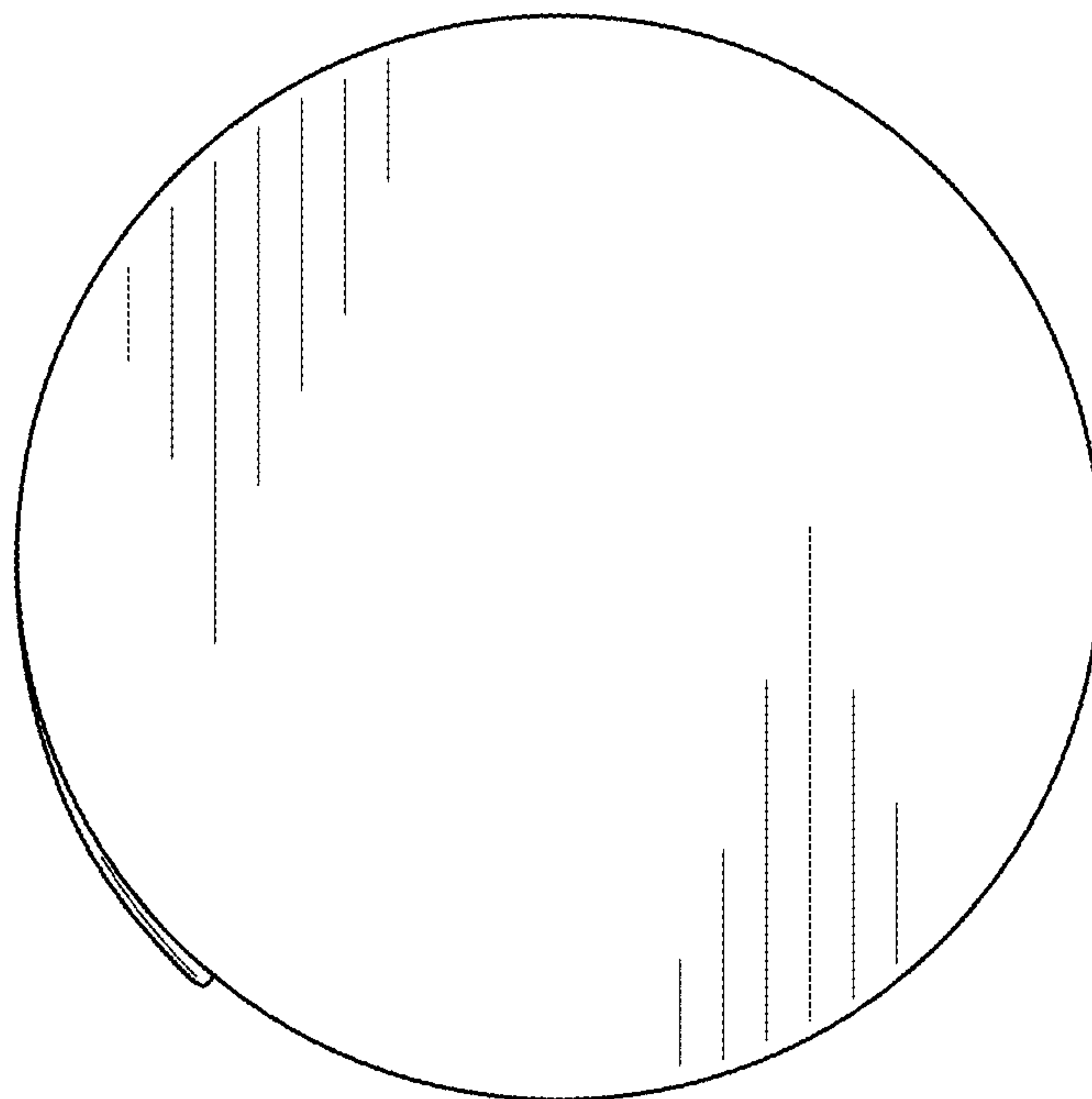

FIG. 18

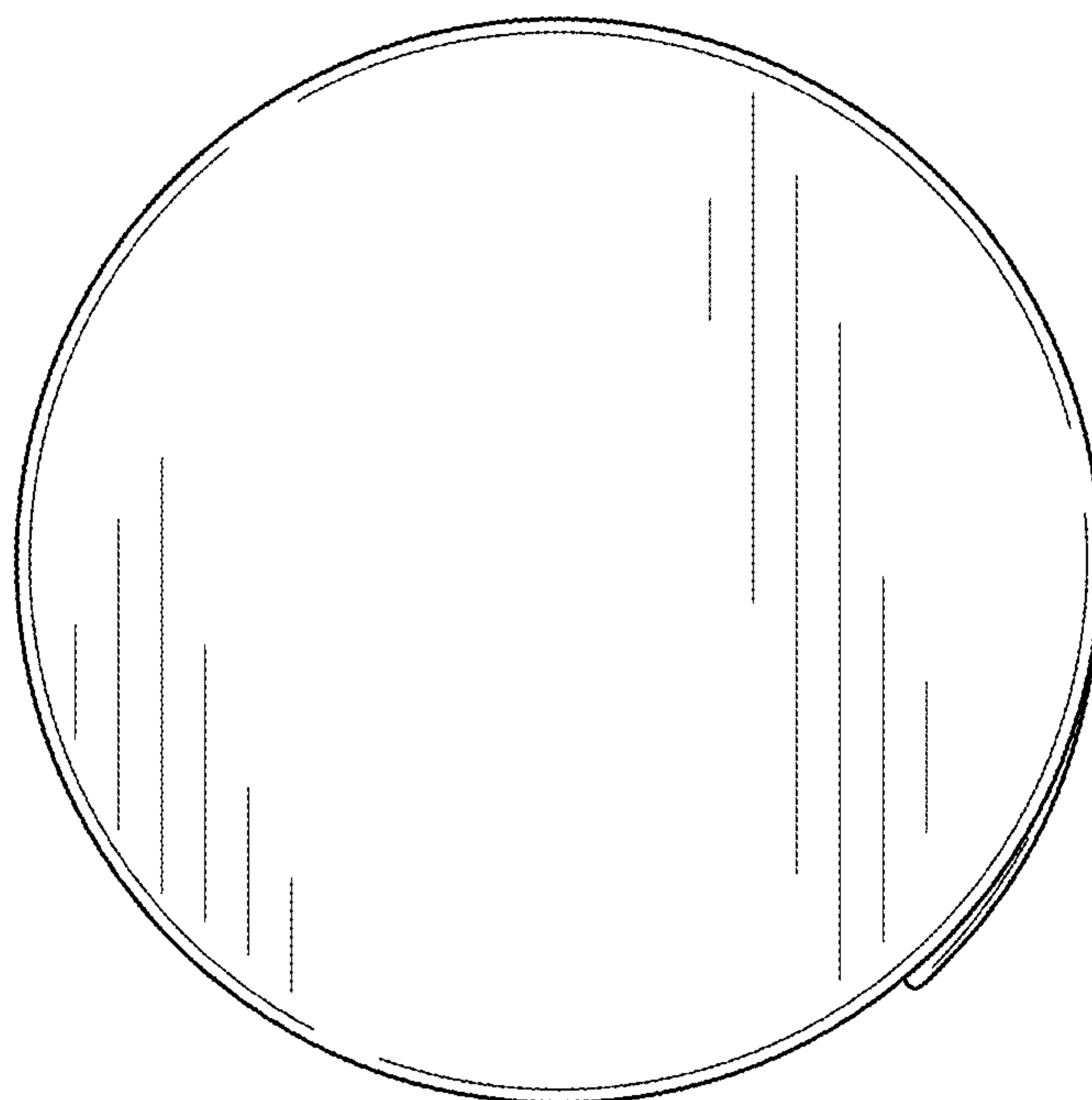

FIG. 19

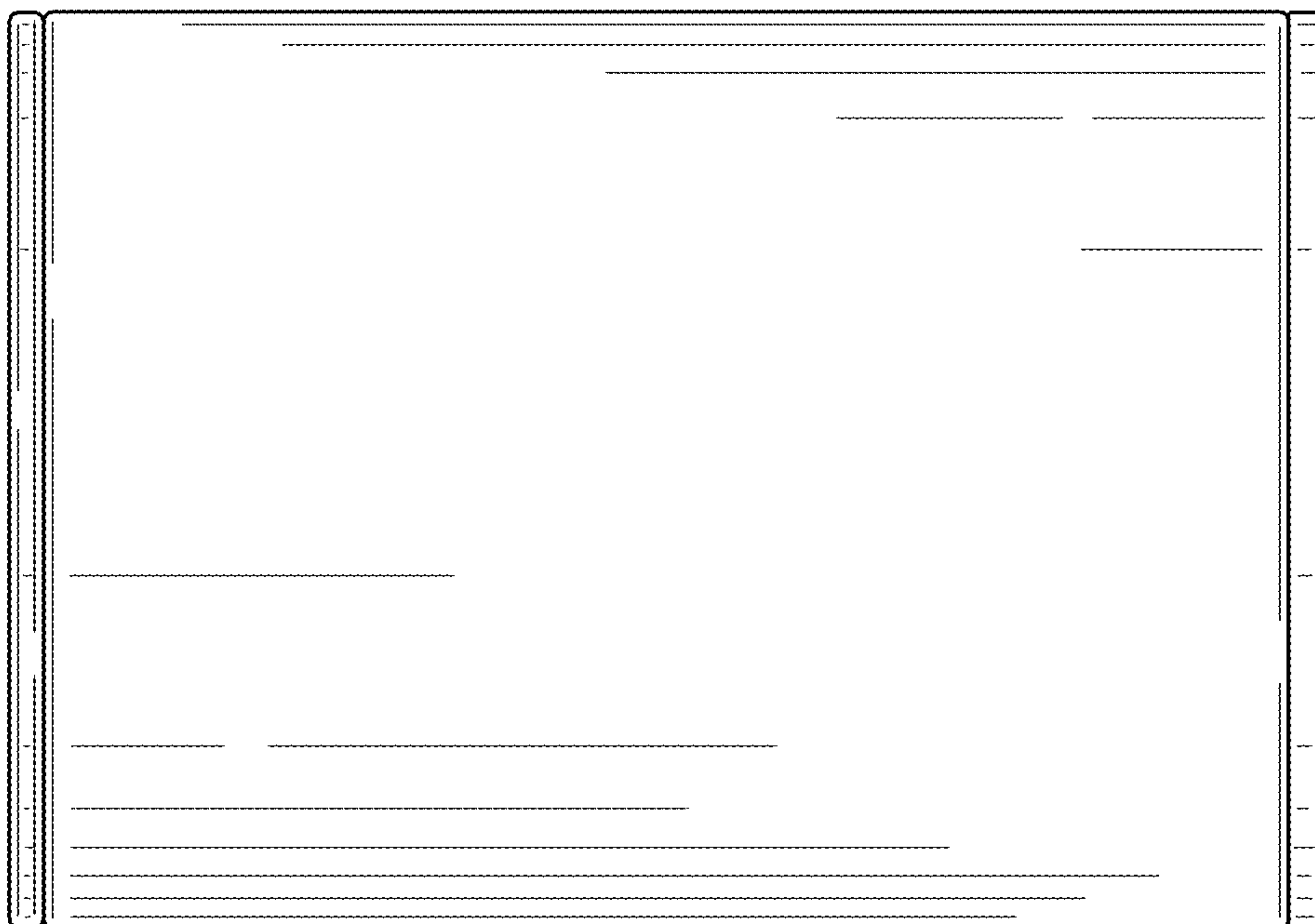

FIG. 20

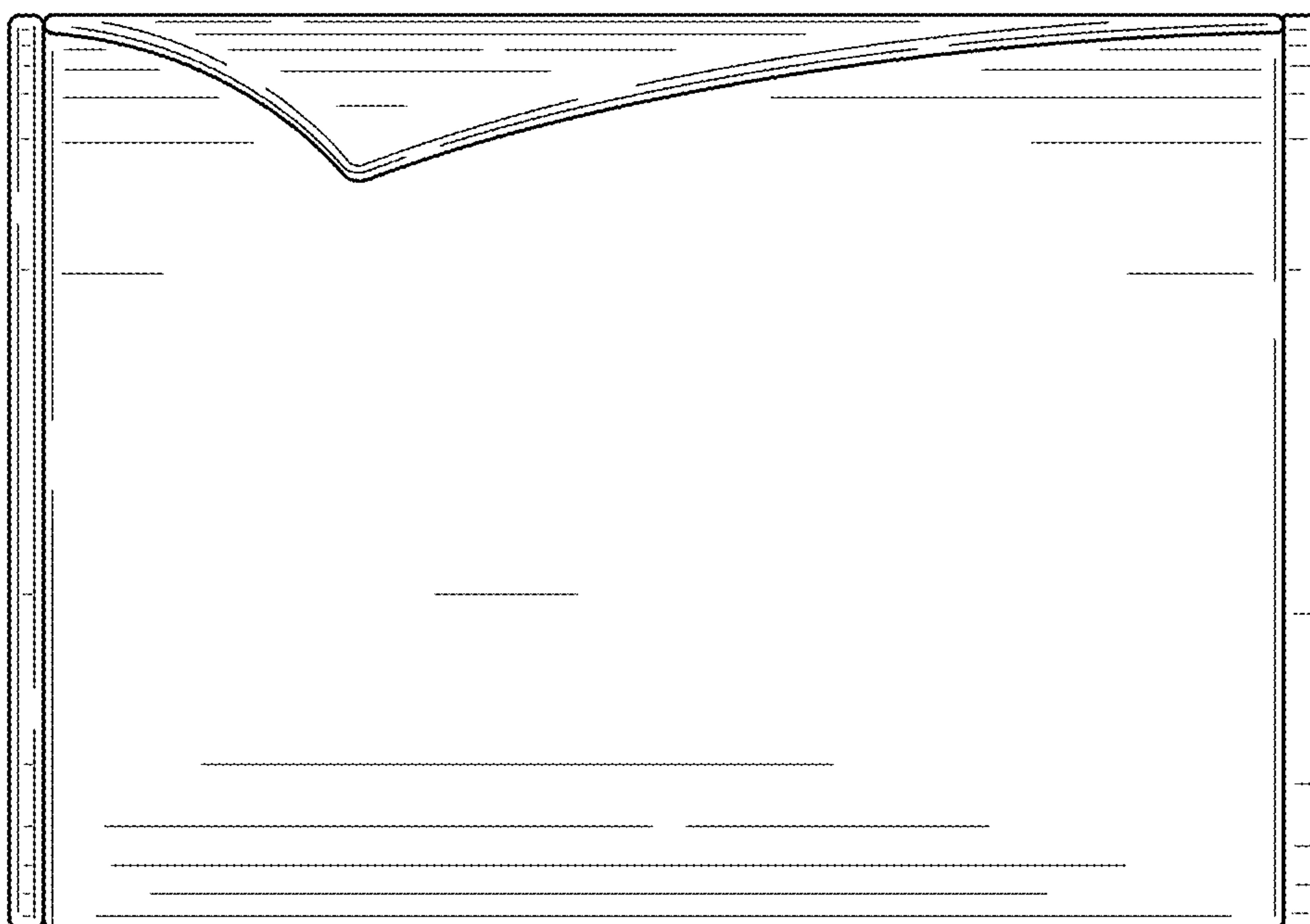

FIG. 21

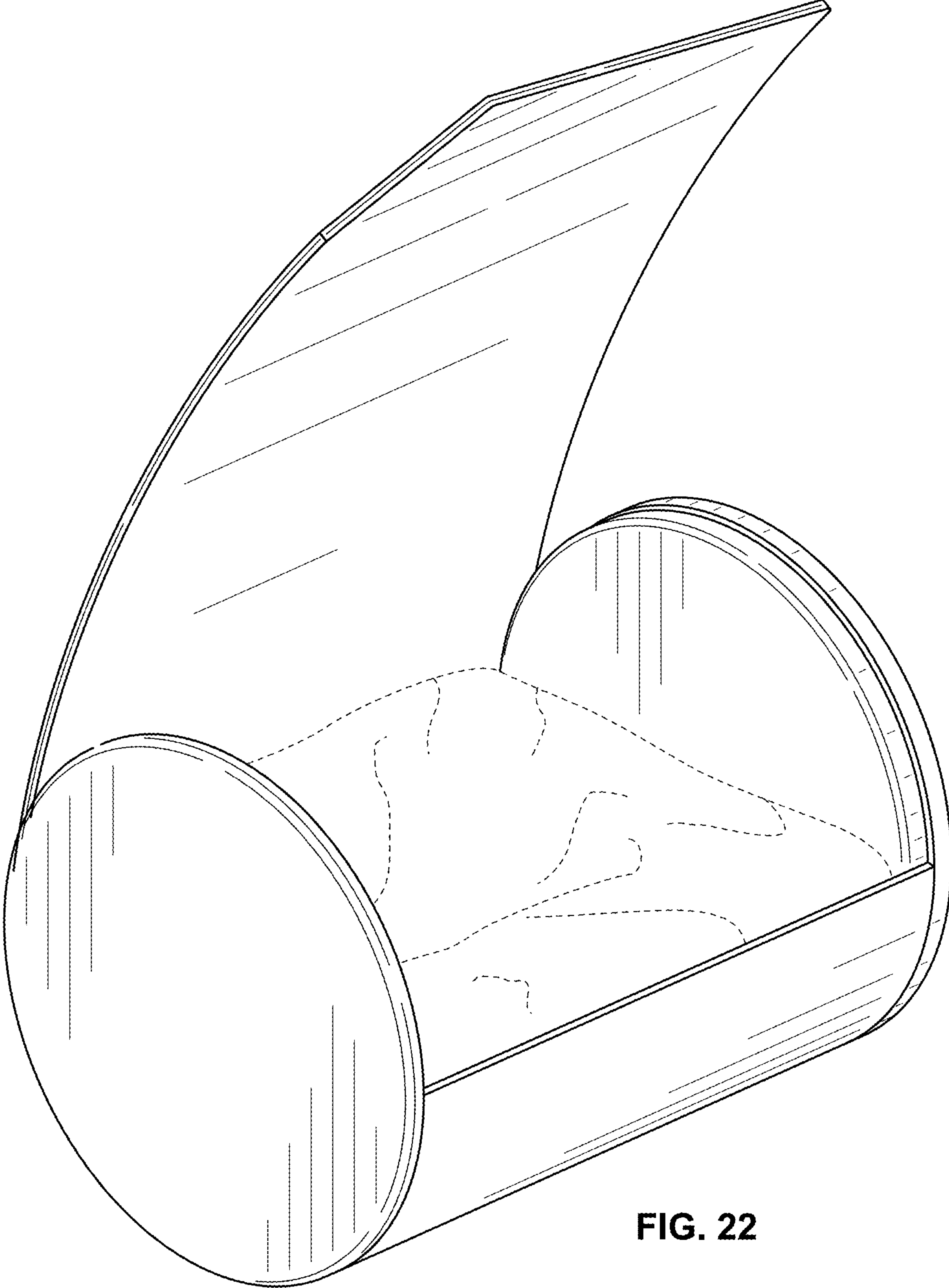

FIG. 22

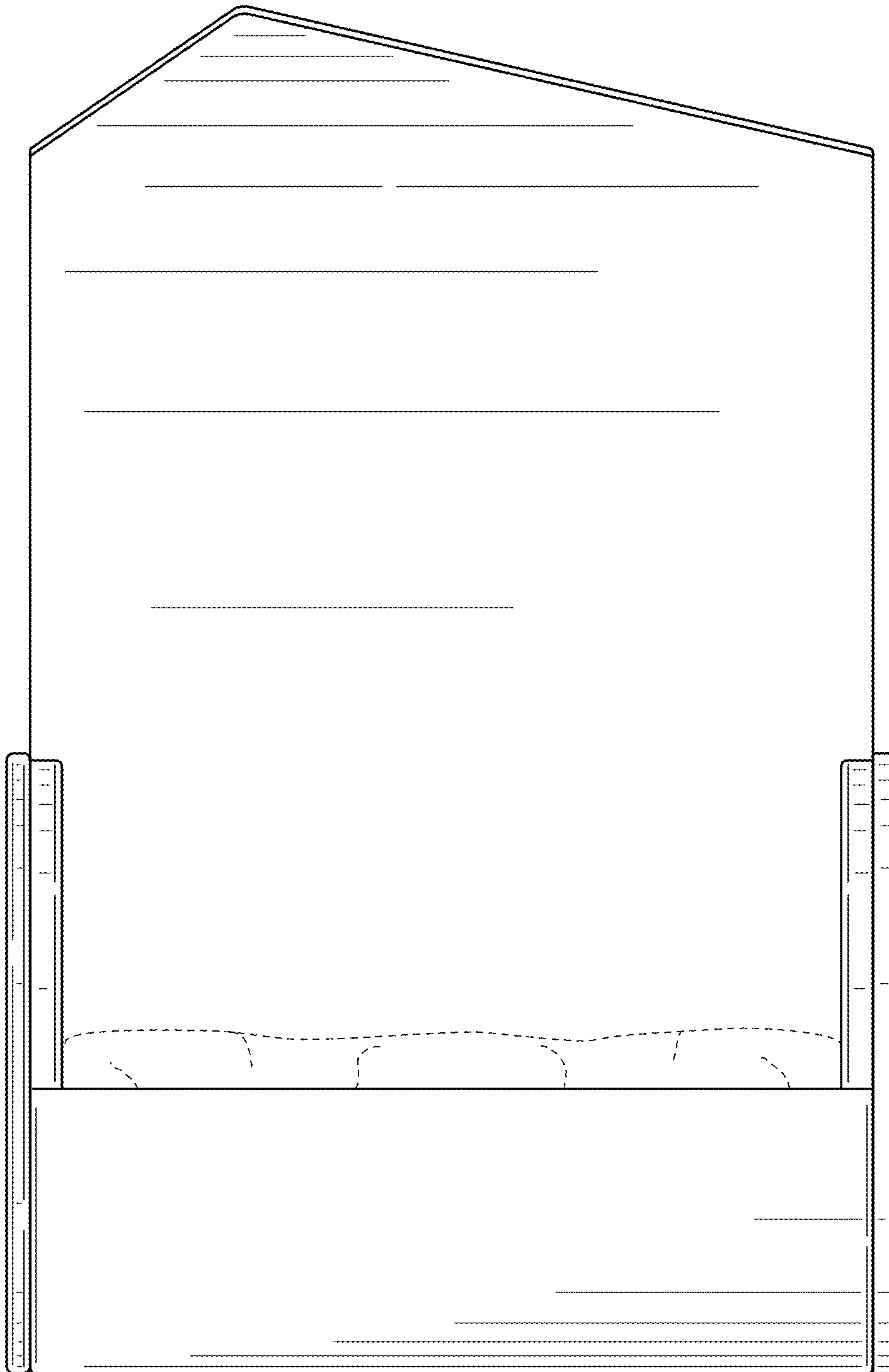

FIG. 23

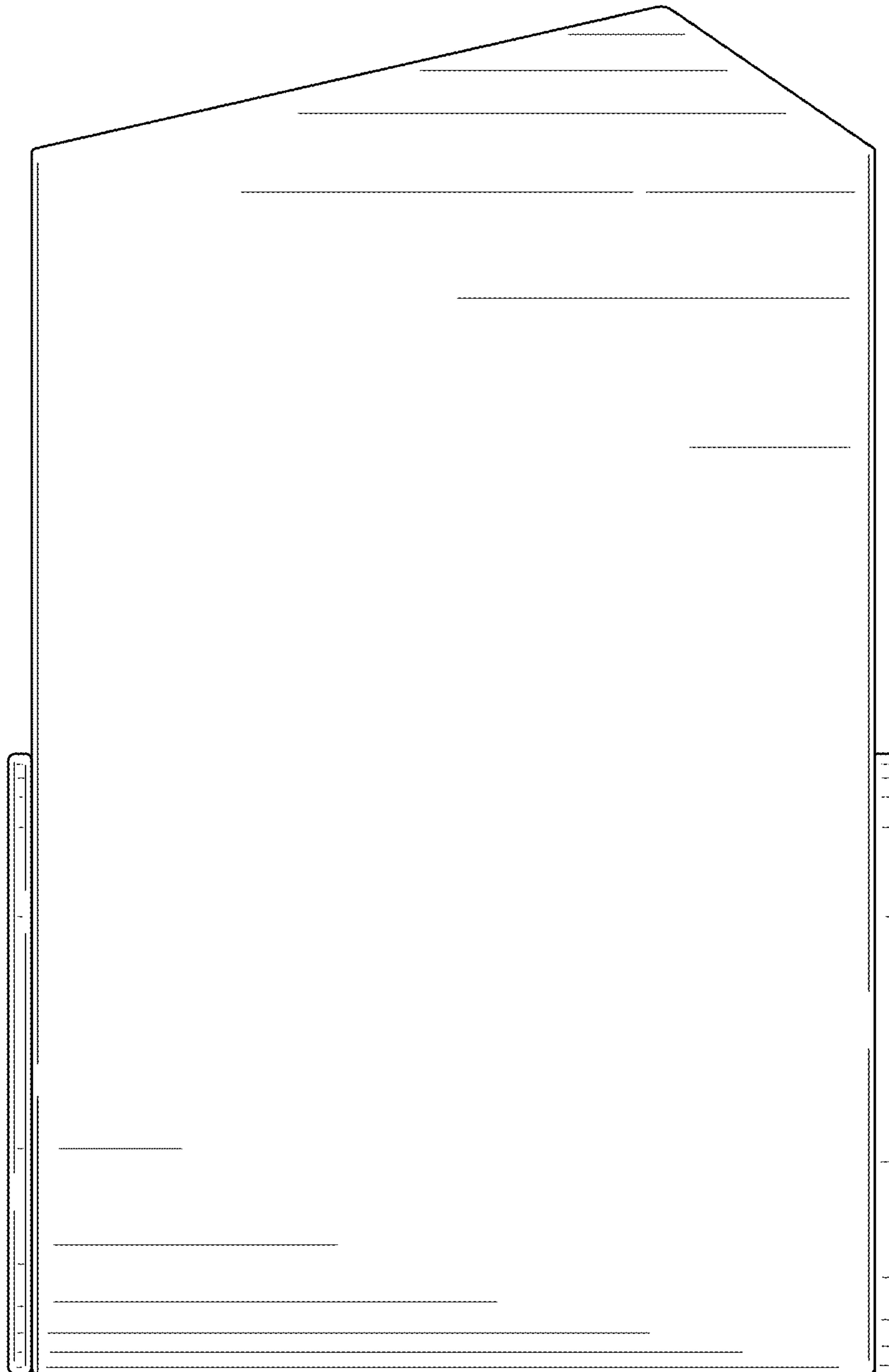

FIG. 24

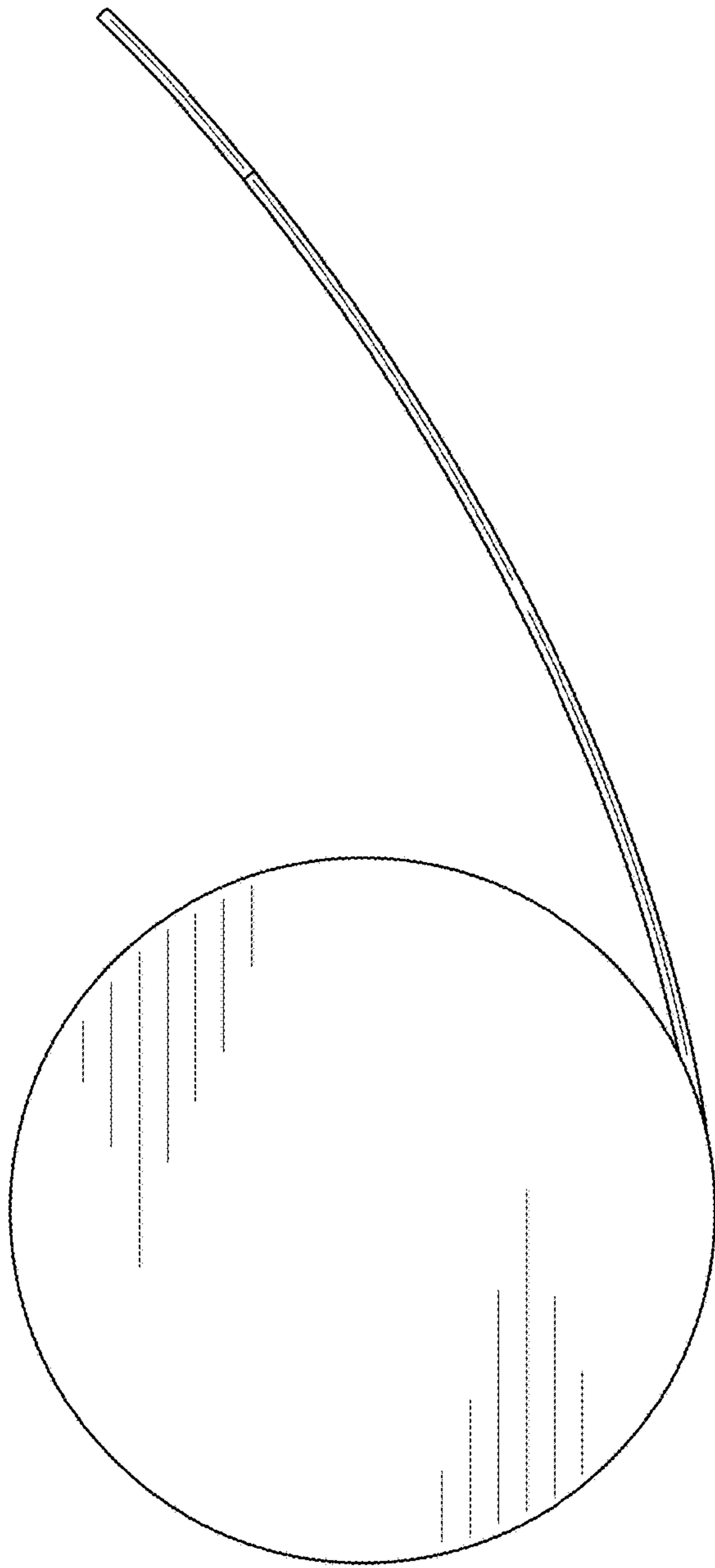

FIG. 25

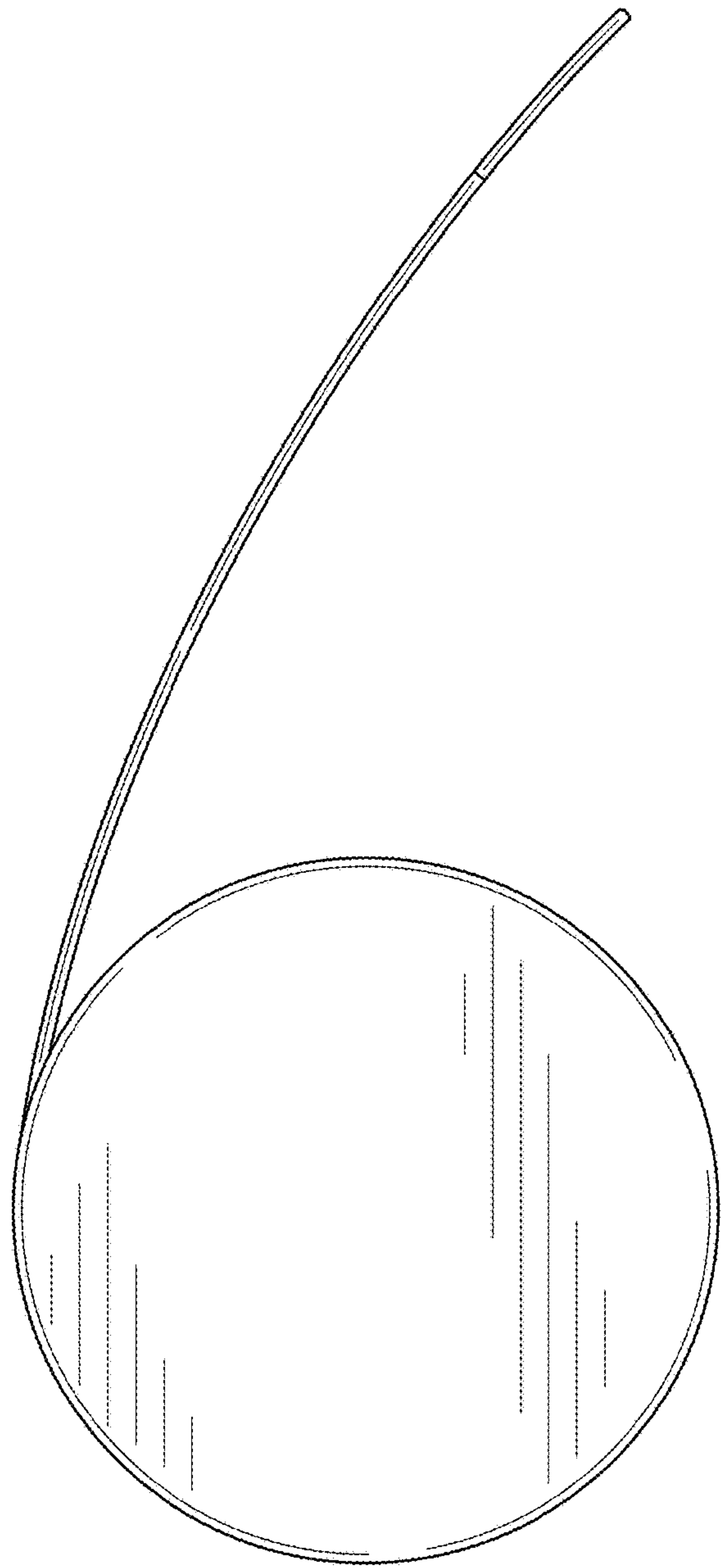

FIG. 26

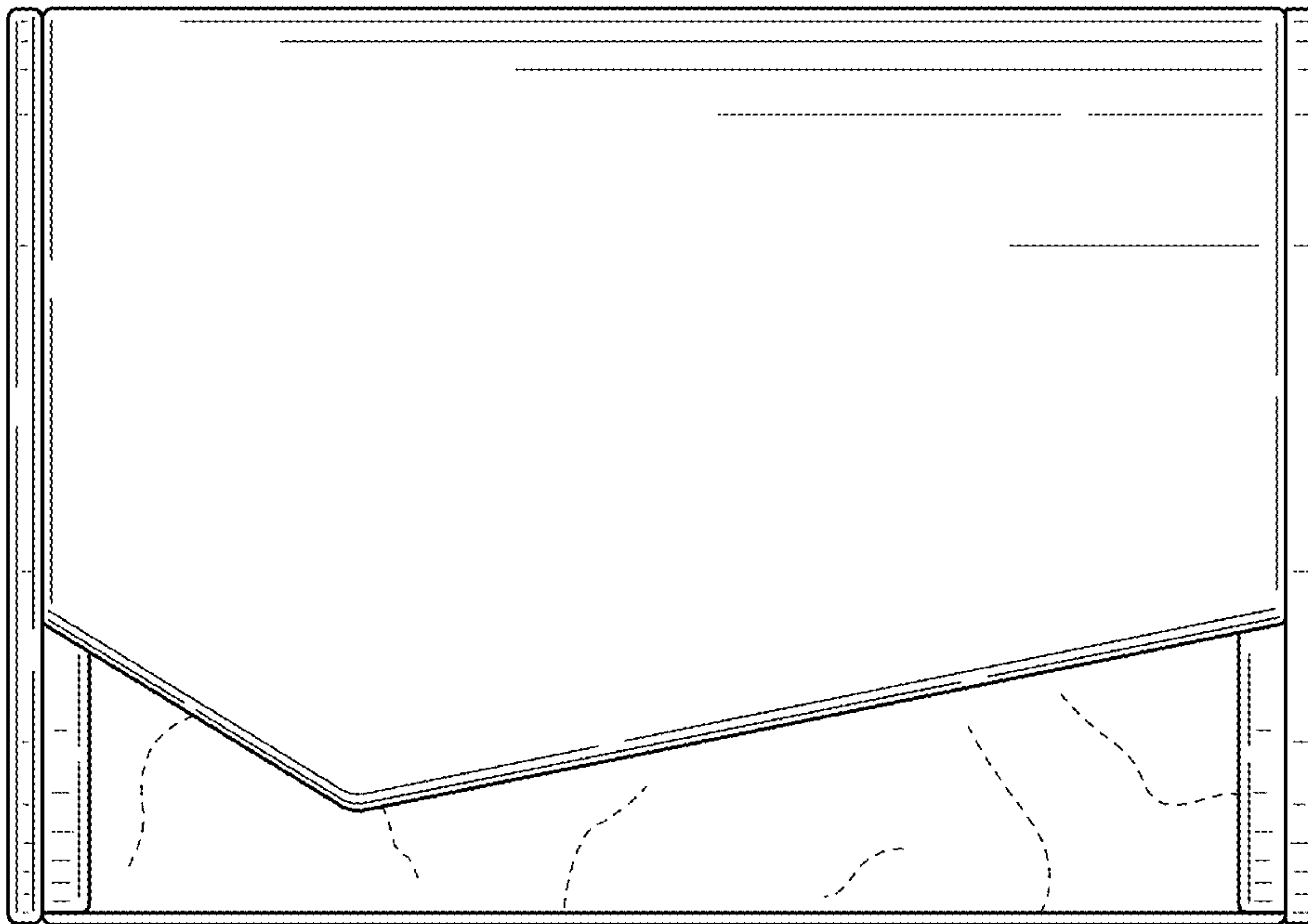

FIG. 27

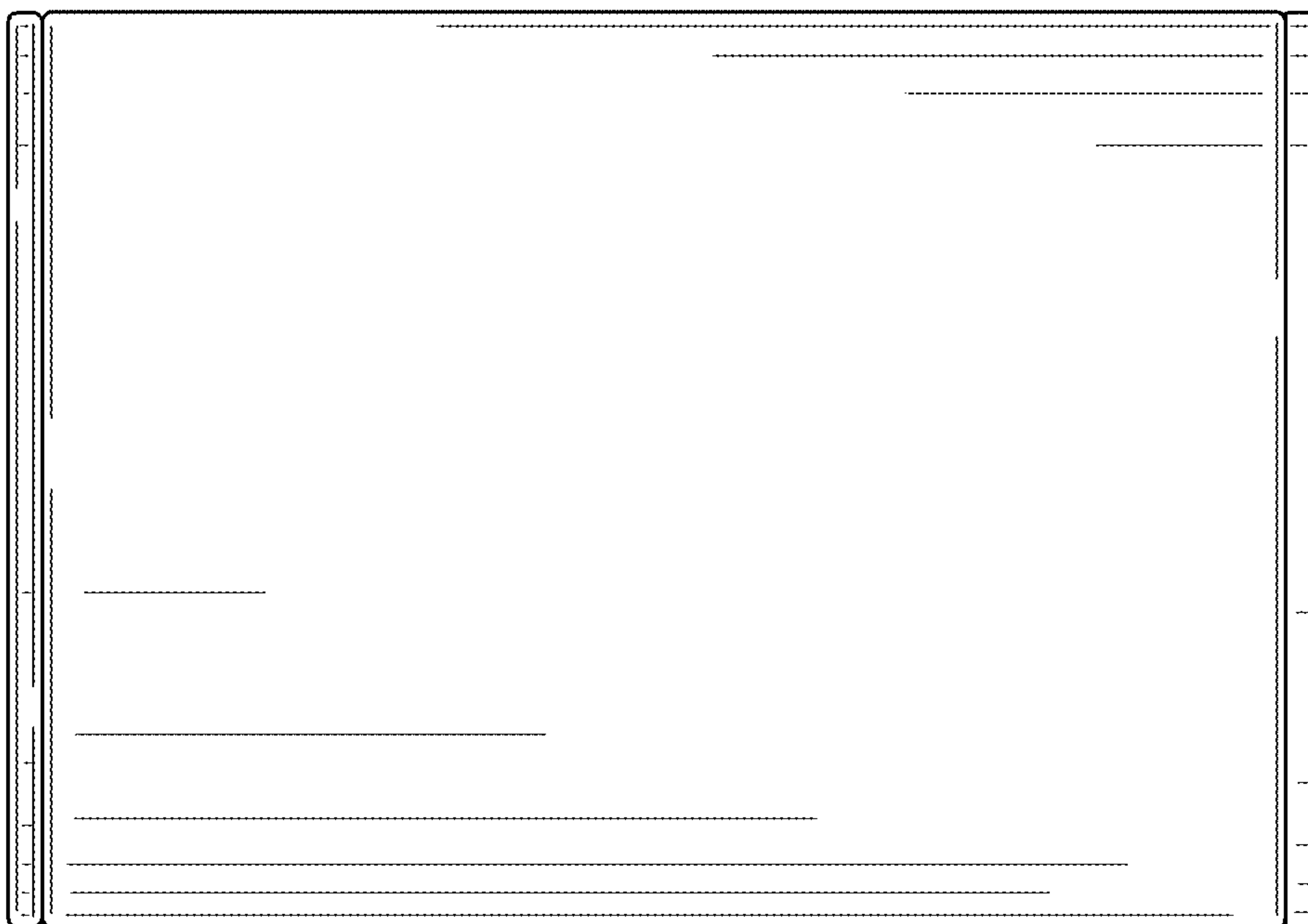

FIG. 28