



US00D799951S

(12) **United States Design Patent**
Habraken

(10) **Patent No.:** **US D799,951 S**

(45) **Date of Patent:** **** Oct. 17, 2017**

(54) **LADYBUG BAG CLIP**

(71) Applicant: **Kikkerland Design, Inc.**, New York, NY (US)

(72) Inventor: **Jan Habraken**, New York, NY (US)

(73) Assignee: **Kikkerland Design, Inc.**, New York, NY (US)

(**) Term: **15 Years**

(21) Appl. No.: **29/544,377**

(22) Filed: **Nov. 3, 2015**

(51) **LOC (10) Cl.** **08-08**

(52) **U.S. Cl.**
USPC **D8/395**

(58) **Field of Classification Search**
USPC D8/71, 354, 373, 383, 394-396; D19/95, D19/68; D7/571, 573
CPC A47G 25/483; A47G 25/485; B65D 33/1658; B65D 33/1675
See application file for complete search history.

(56) **References Cited**

U.S. PATENT DOCUMENTS

- 462,358 A * 11/1891 Knowles A47G 25/485 211/89.01
- D406,170 S * 2/1999 Wolff D19/65
- D505,635 S * 5/2005 McGee D11/78.1

- D512,137 S * 11/2005 Chen D23/367
- D550,074 S * 9/2007 Lam D3/206
- D559,673 S * 1/2008 Dash D8/395
- D627,152 S * 11/2010 Williams D3/203.3
- D640,807 S * 6/2011 Weiser D22/120
- D671,822 S * 12/2012 van der Lande D8/395
- D684,849 S * 6/2013 Bylsma D8/395
- D687,385 S * 8/2013 Ott D13/156
- D740,111 S * 10/2015 Espinoza D8/395
- D755,516 S * 5/2016 Krenkler D3/264
- D755,620 S * 5/2016 Li D8/395
- D794,437 S * 8/2017 Zinser D8/395
- D795,050 S * 8/2017 Kim D8/395

* cited by examiner

Primary Examiner — Melanie H Tung

Assistant Examiner — Bao-Yen Nguyen

(74) *Attorney, Agent, or Firm* — Charles H. Jew

(57) **CLAIM**

The ornamental design for a ladybug bag clip, as shown and described.

DESCRIPTION

FIG. 1 is a top view of the ladybug bag clip showing my design;

FIG. 2 is a bottom view thereof;

FIG. 3 is a front view thereof;

FIG. 4 is a rear view thereof;

FIG. 5 is a left side view thereof;

FIG. 6 is a right side view thereof; and,

FIG. 7 is a top front perspective view thereof.

1 Claim, 2 Drawing Sheets

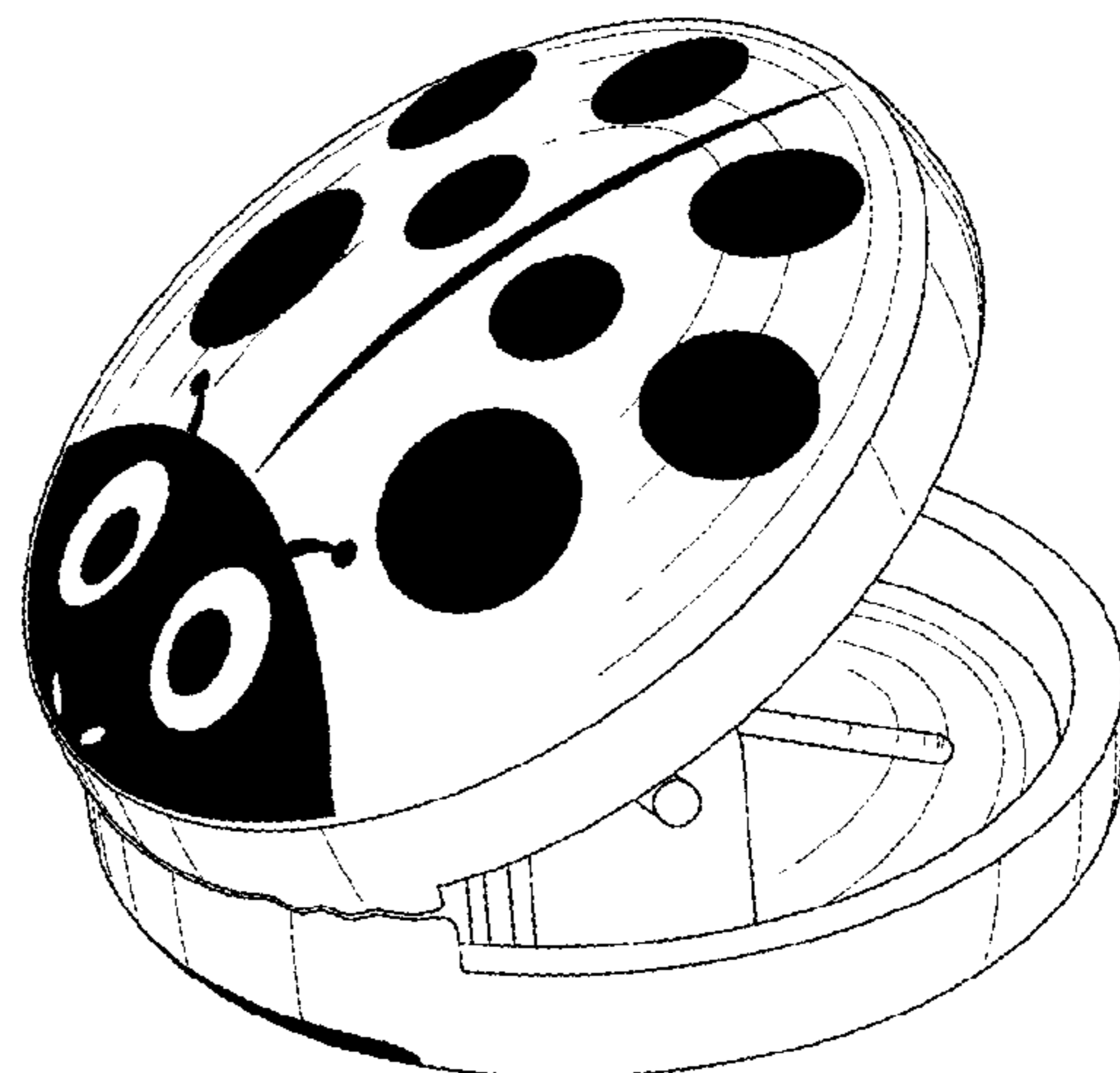
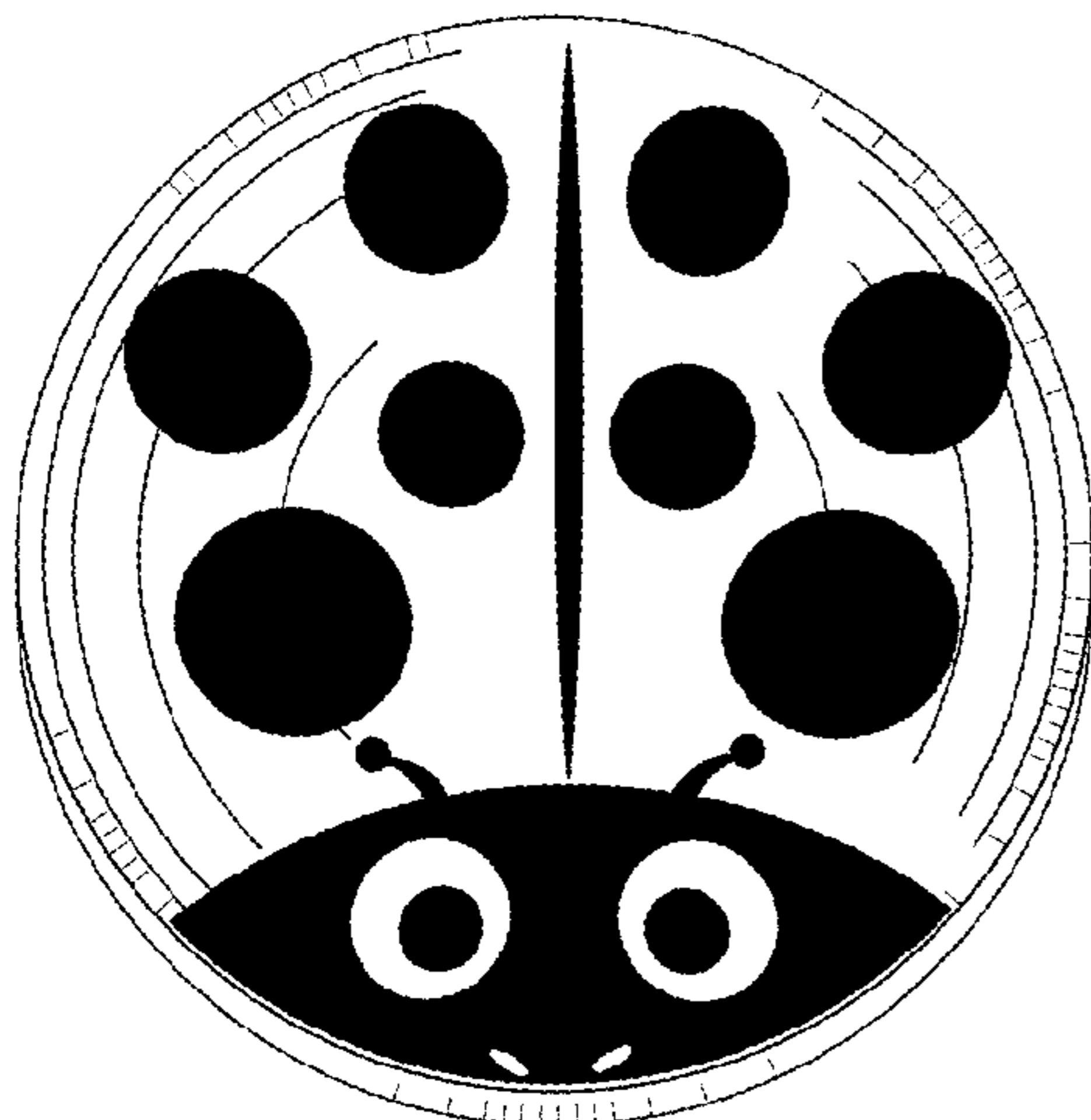

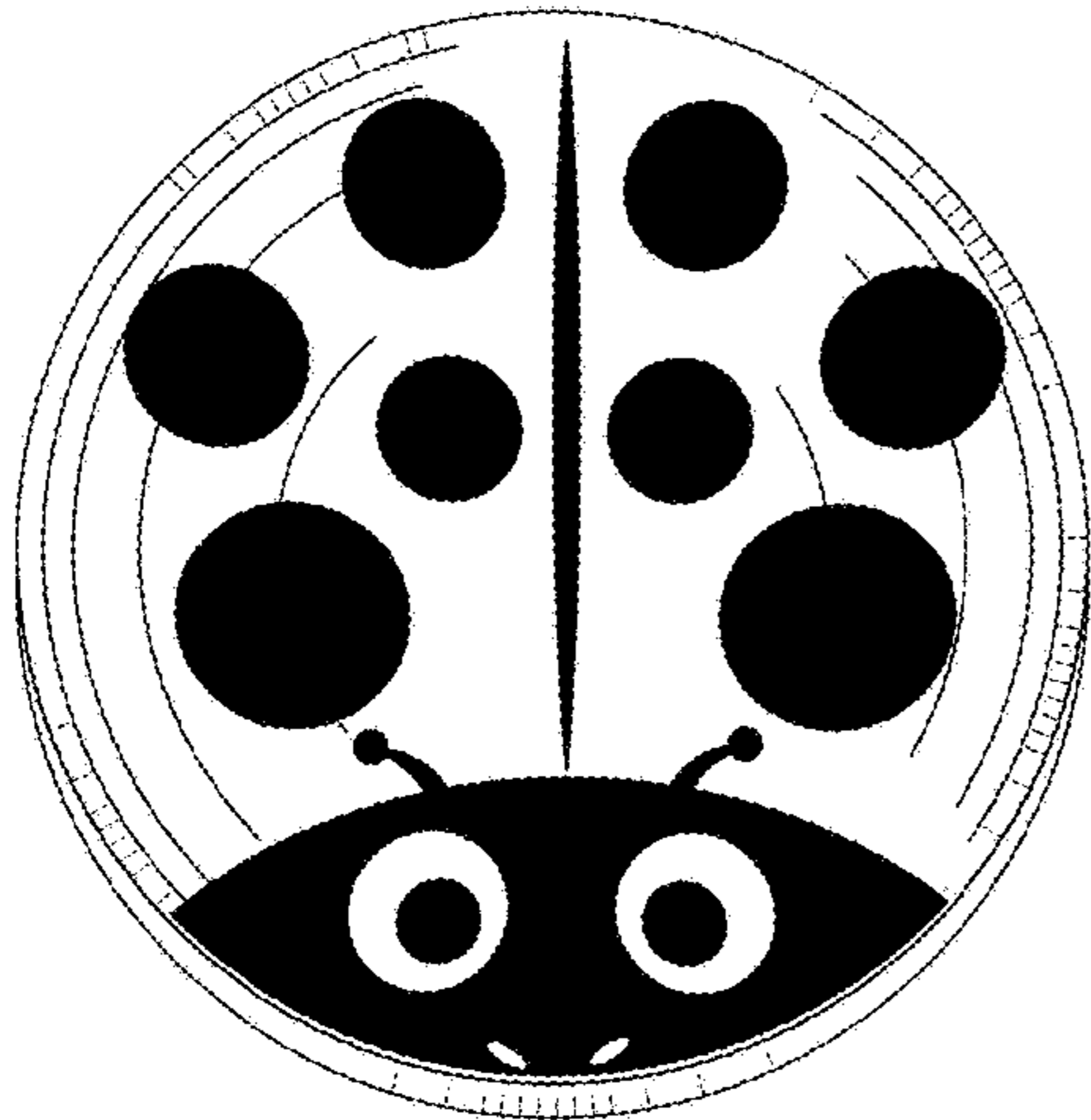

FIG. 1

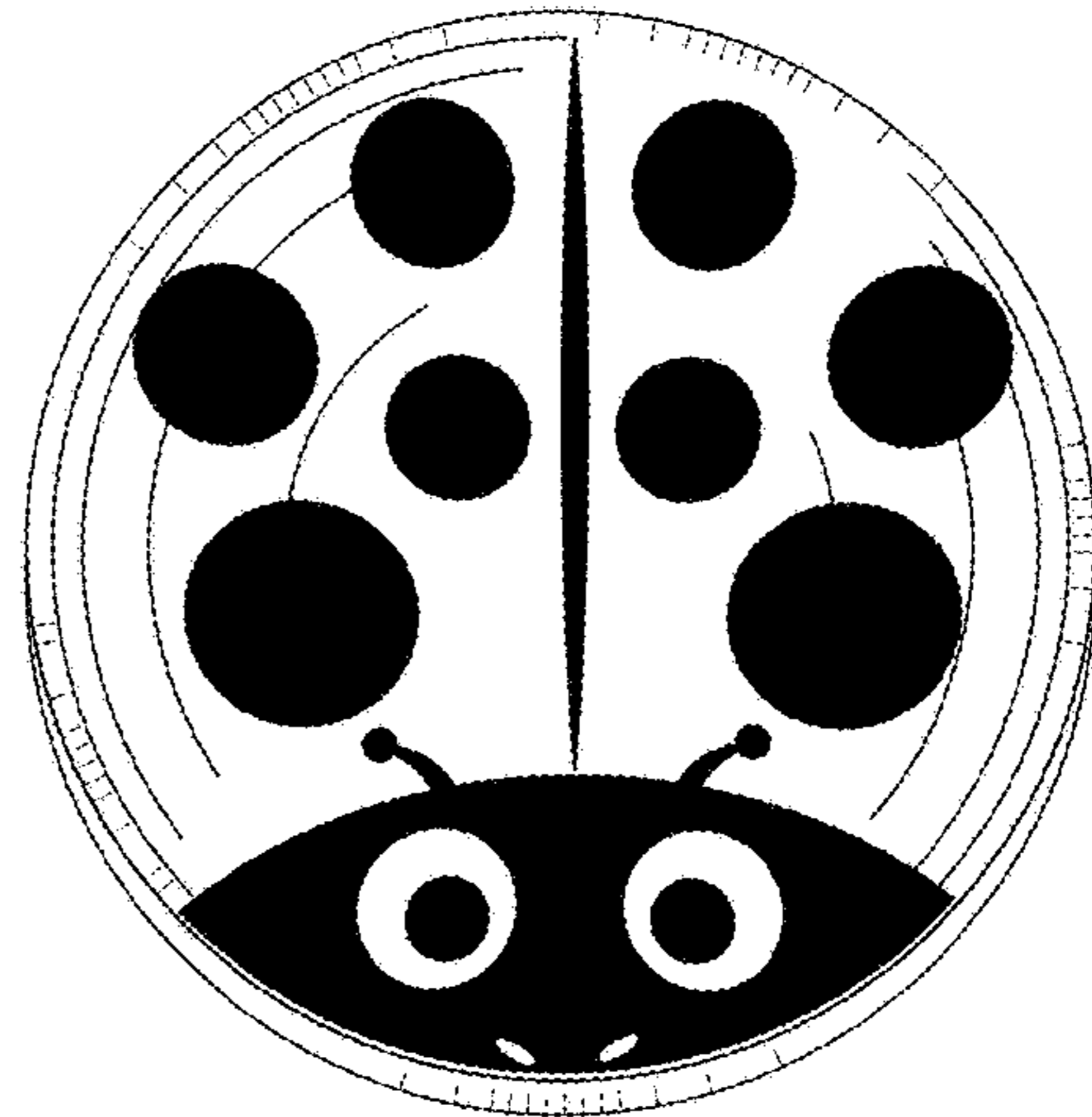

FIG. 2

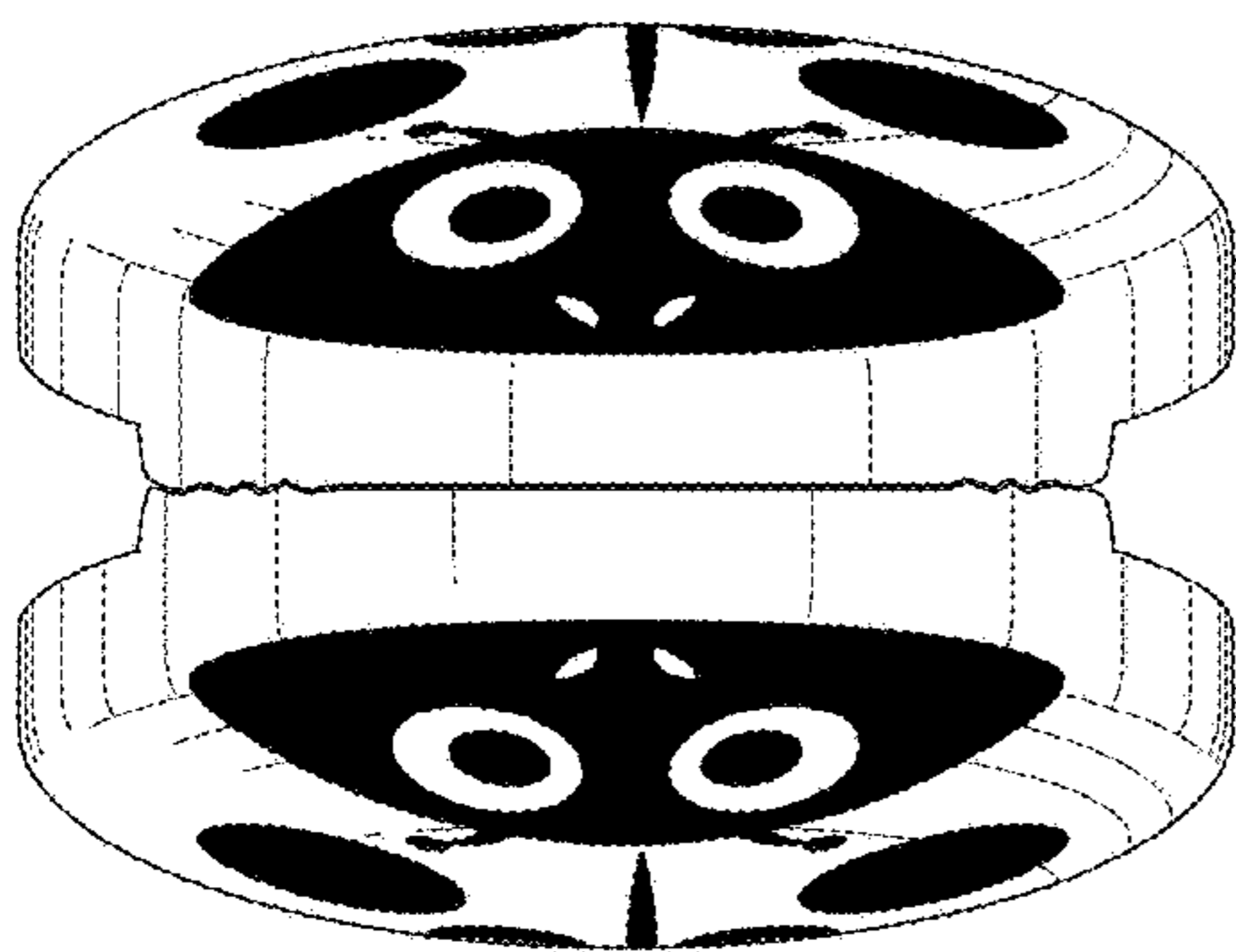

FIG. 3

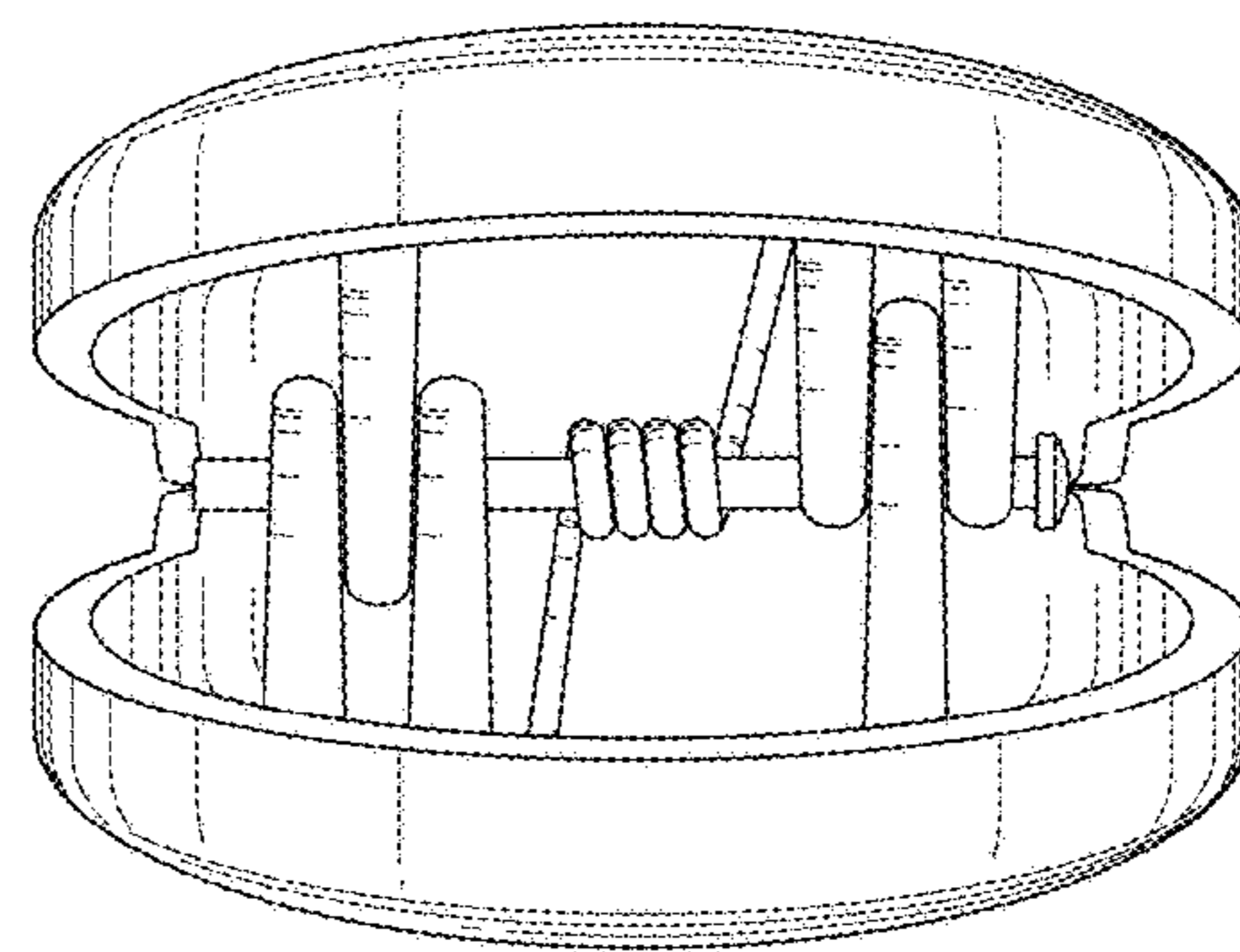

FIG. 4

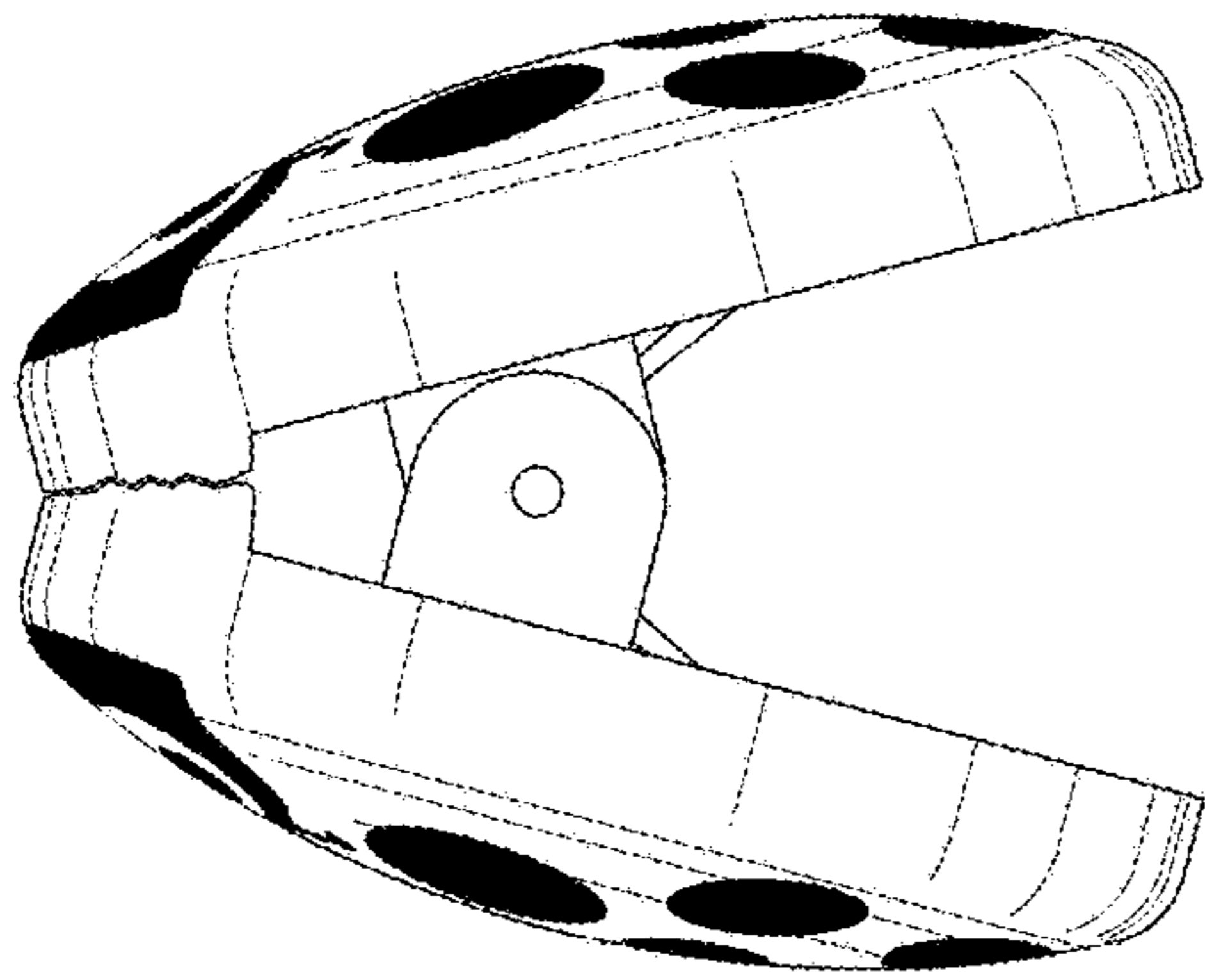

FIG. 5

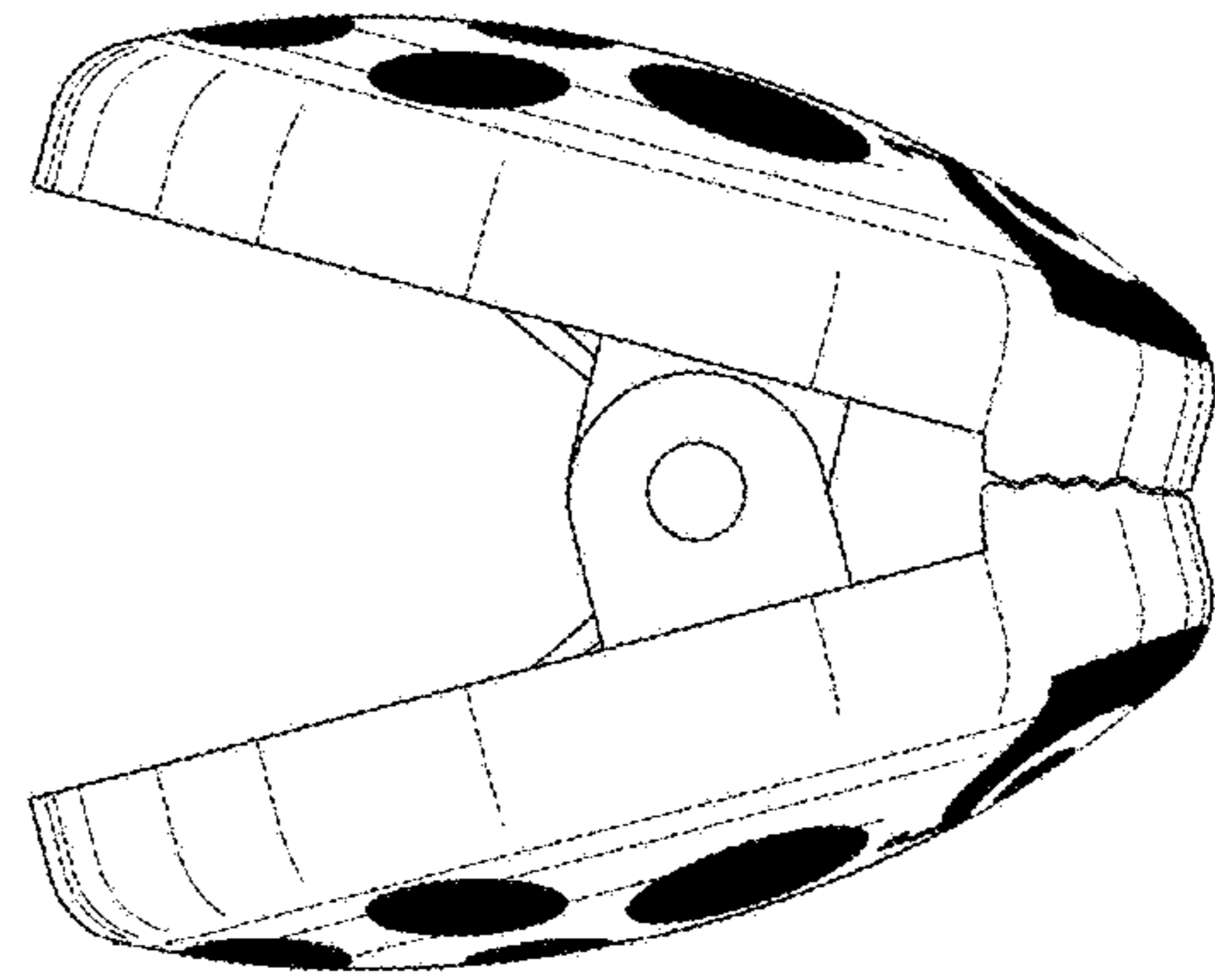

FIG. 6

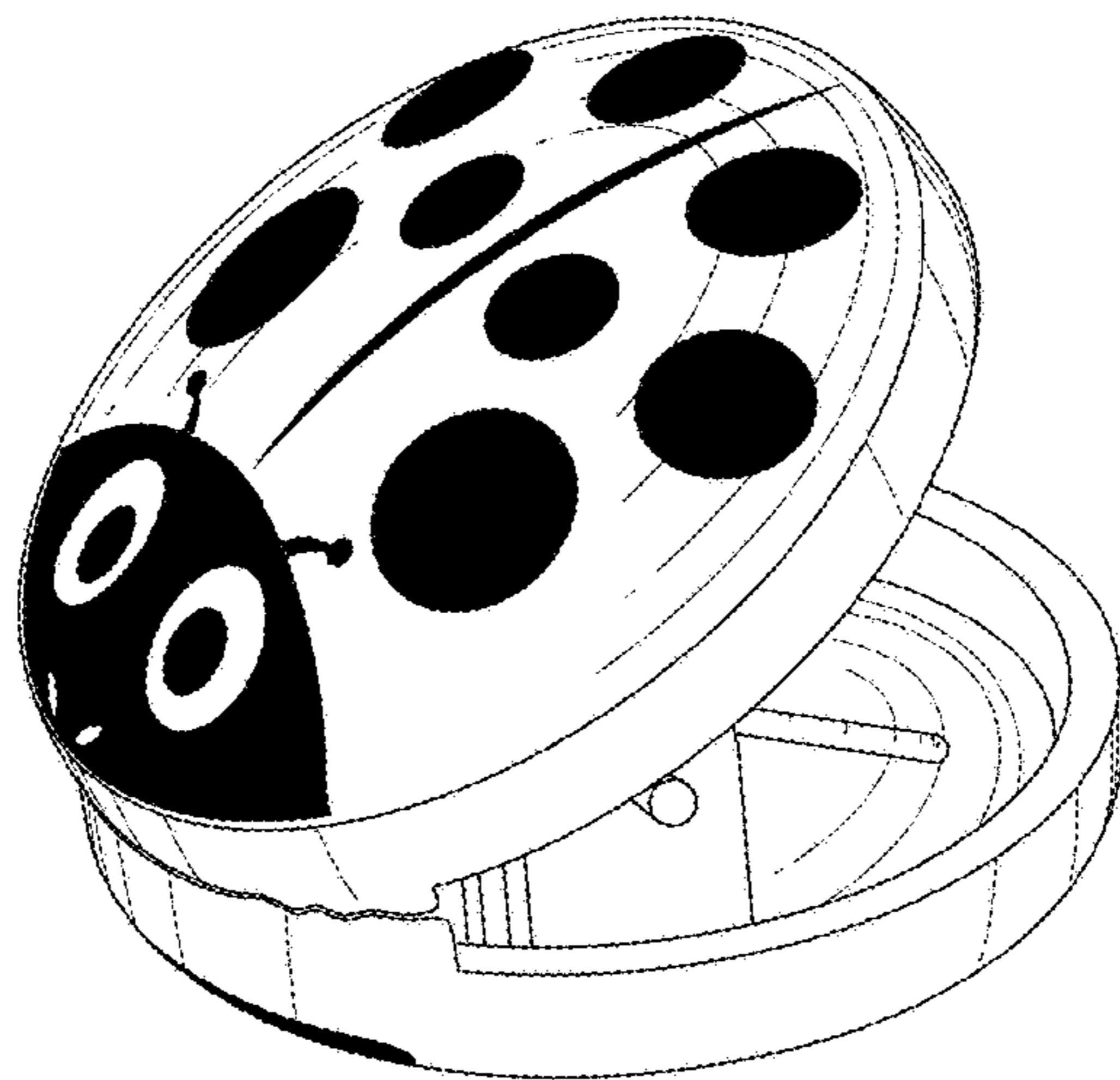

FIG. 7