



US00D799893S

(12) **United States Design Patent** (10) **Patent No.:** **US D799,893 S**  
**Westrick** (45) **Date of Patent:** **\*\* Oct. 17, 2017**

(54) **GLASS CHARM**

(71) Applicant: **True Fabrications, Inc.**, Seattle, WA (US)

(72) Inventor: **Amy Jo Westrick**, Seattle, WA (US)

(73) Assignee: **TRUE FABRICATIONS, INC.**, Seattle, WA (US)

(\*\*) Term: **15 Years**

(21) Appl. No.: **29/586,261**

(22) Filed: **Dec. 1, 2016**

(51) **LOC (10) Cl.** ..... **07-99**

(52) **U.S. Cl.**  
USPC ..... **D7/396.2; D7/389; D7/387**

(58) **Field of Classification Search**  
USPC .... **D7/387, 389, 396.2, 396.6, 213; D9/434; D11/40, 48, 79, 81**  
CPC ..... **A47G 19/22**  
See application file for complete search history.

(56) **References Cited**

**U.S. PATENT DOCUMENTS**

D484,360 S	*	12/2003	Lombardi	.....	D7/396.1
D530,744 S	*	10/2006	Harrison	.....	D19/116
D585,297 S	*	1/2009	Nielsen	.....	D9/646
D625,163 S	*	10/2010	Moman	.....	D8/38
D675,866 S	*	2/2013	Wisniewski	.....	D7/213

\* cited by examiner

*Primary Examiner* — Daniel Bui  
*Assistant Examiner* — Andrew Kerr  
(74) *Attorney, Agent, or Firm* — Vicky Kaur Bajwa

(57) **CLAIM**

The ornamental design for a glass charm, as shown and described.

**DESCRIPTION**

FIG. 1 is a front elevation view of a glass charm showing my new design;  
FIG. 2 is a rear elevation view of the glass charm of FIG. 1;  
FIG. 3 is a left side elevation view of the glass charm of FIG. 1; the right side being a mirror image thereof;  
FIG. 4 is a top view of the glass charm of FIG. 1;  
FIG. 5 is a bottom view of the glass charm of FIG. 1;  
FIG. 6 is a bottom perspective view of the front of the glass charm of FIG. 1;  
FIG. 7 is a bottom perspective view of the rear of the glass charm of FIG. 1;  
FIG. 8 is a front elevation view of a second embodiment of the glass charm;  
FIG. 9 is a rear elevation view of the glass charm of FIG. 8;  
FIG. 10 is a left side elevation view of the glass charm of FIG. 8; the right side being a mirror image thereof;  
FIG. 11 is a top view of the glass charm of FIG. 8;  
FIG. 12 is a bottom view of the glass charm of FIG. 8;  
FIG. 13 is a bottom perspective view of the front of the glass charm of FIG. 8; and,  
FIG. 14 is a bottom perspective view of the rear of the glass charm of FIG. 8.

**1 Claim, 2 Drawing Sheets**

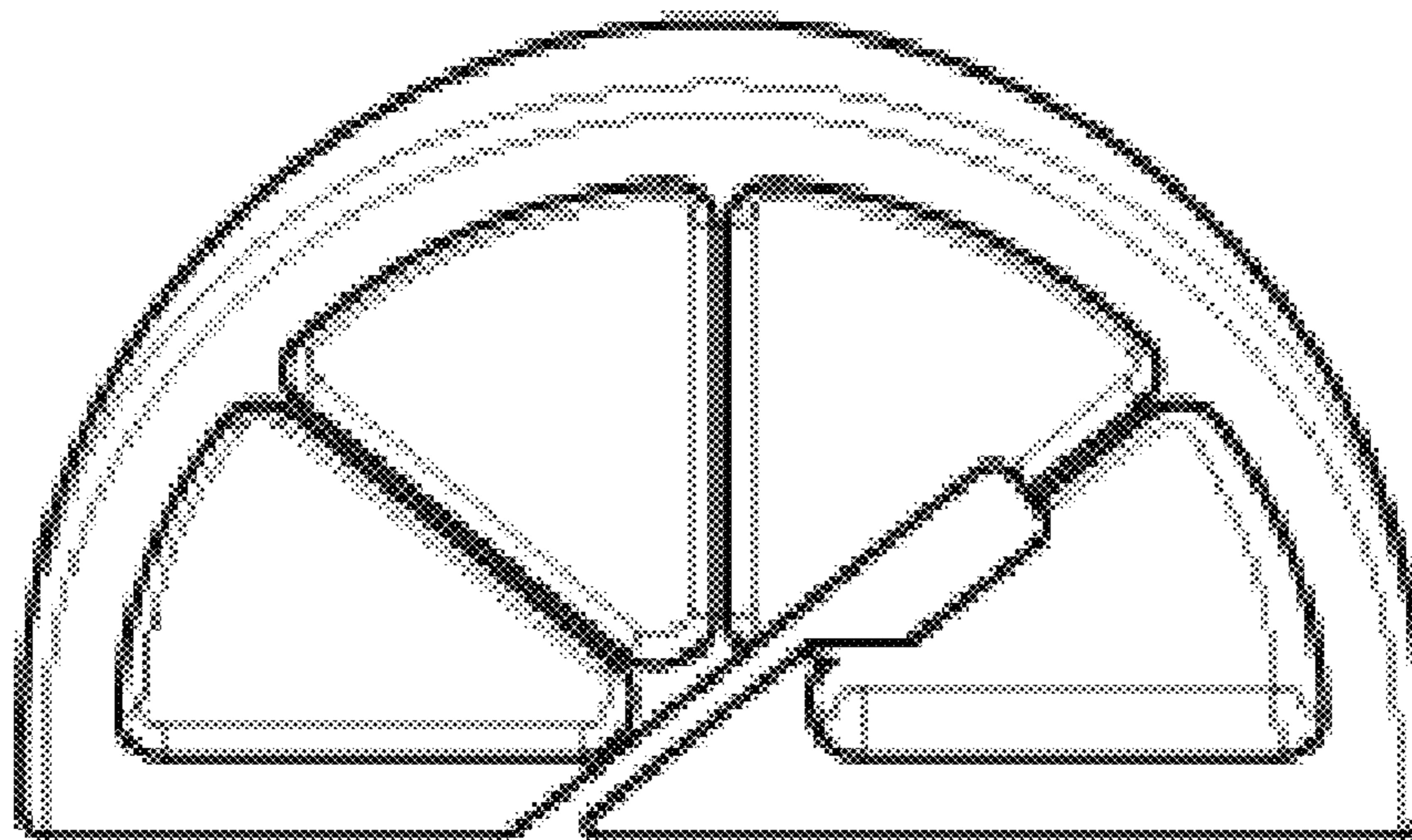

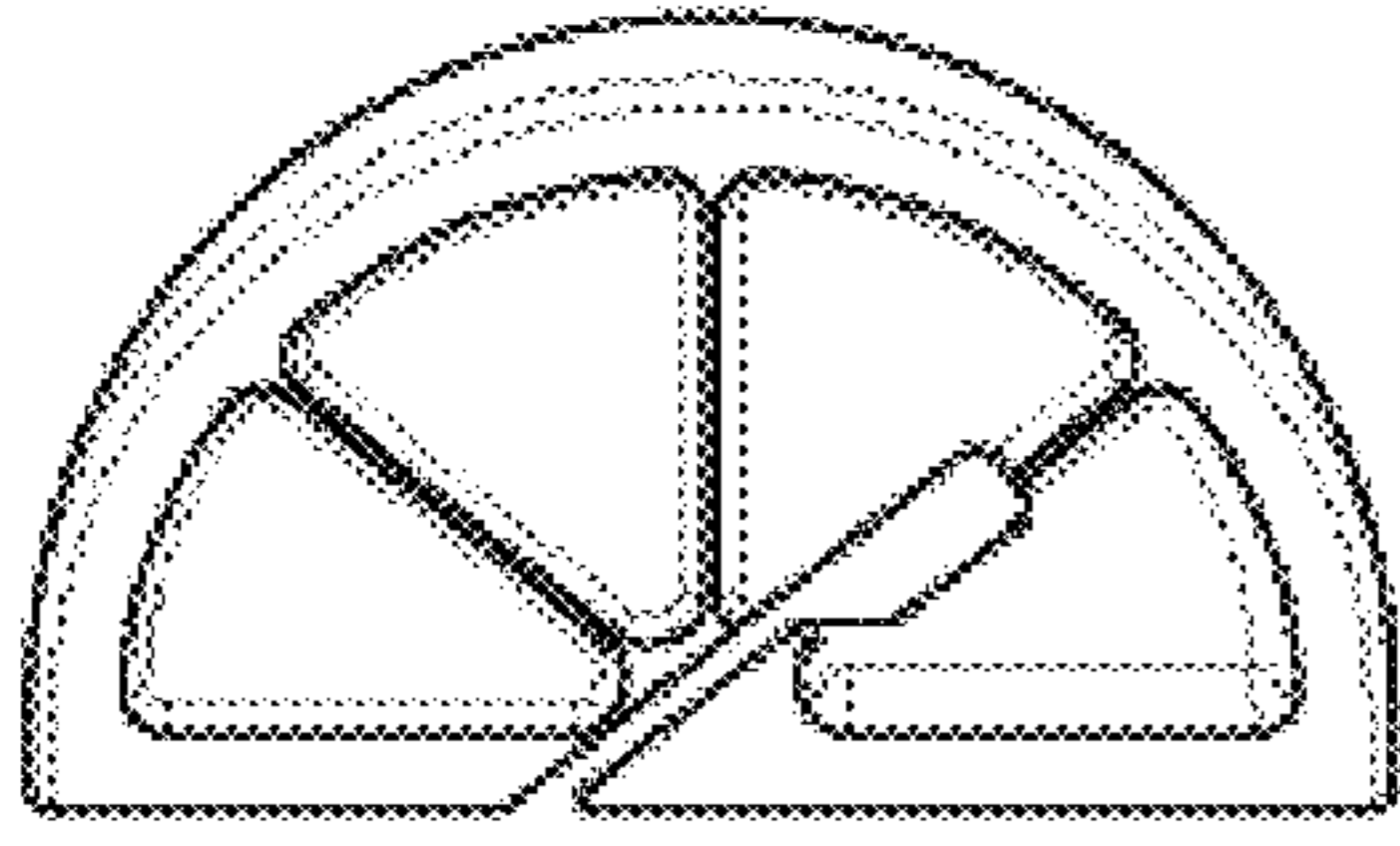

FIG. 1

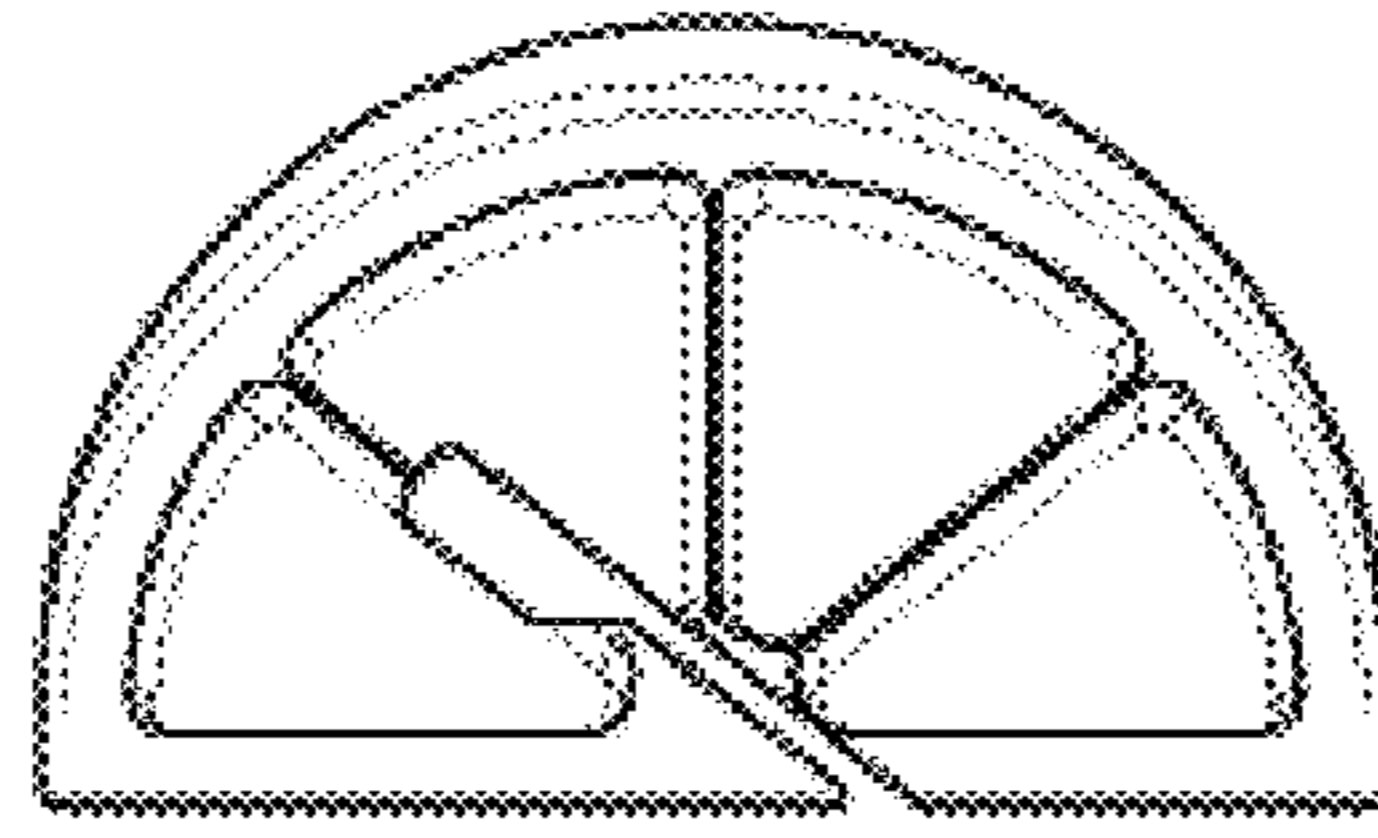

FIG. 2

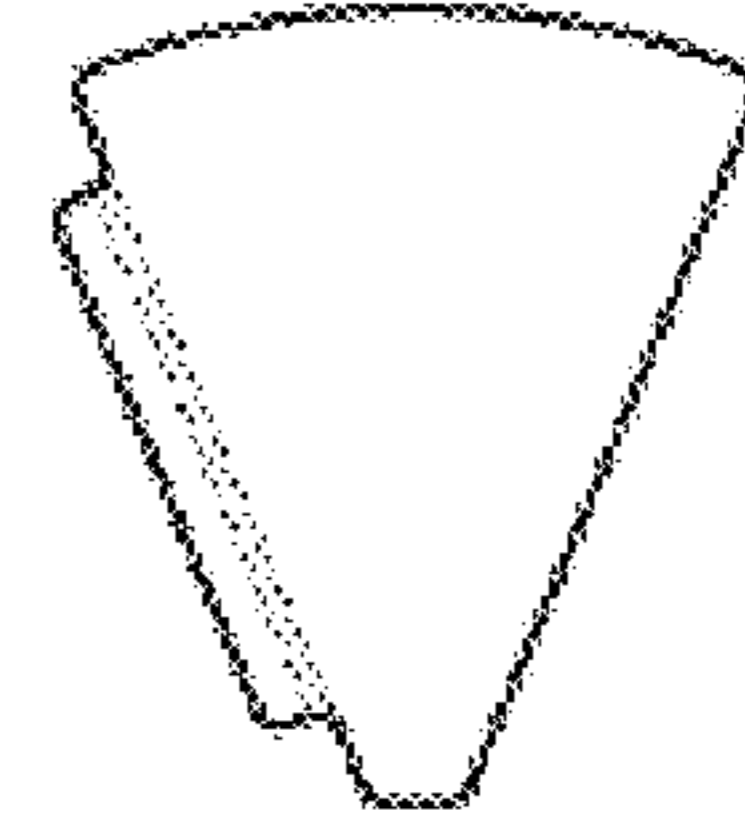

FIG. 3

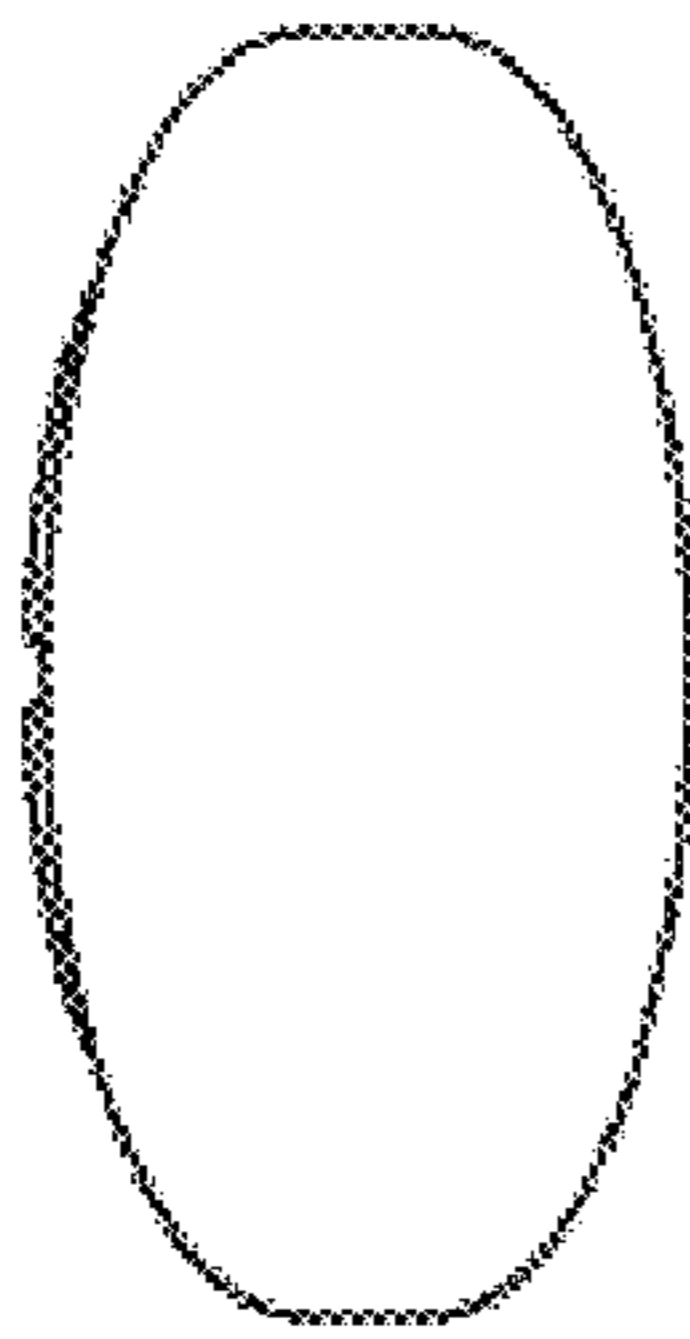

FIG. 4

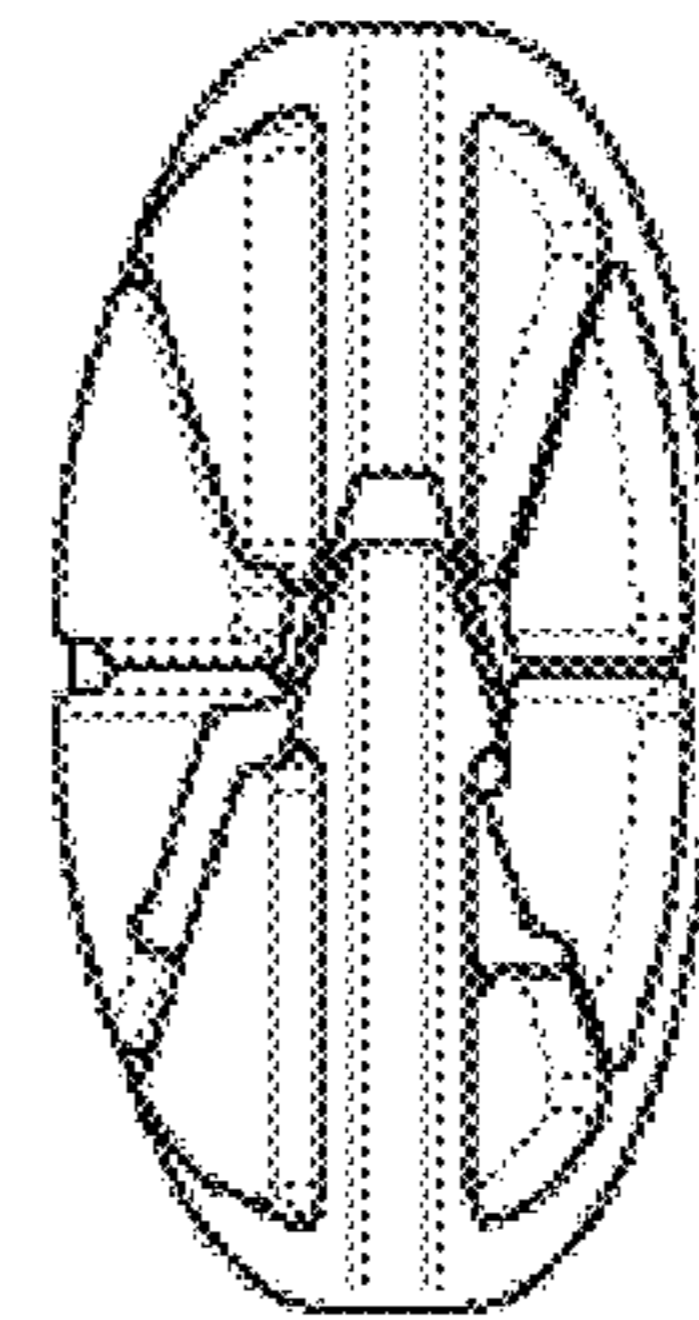

FIG. 5

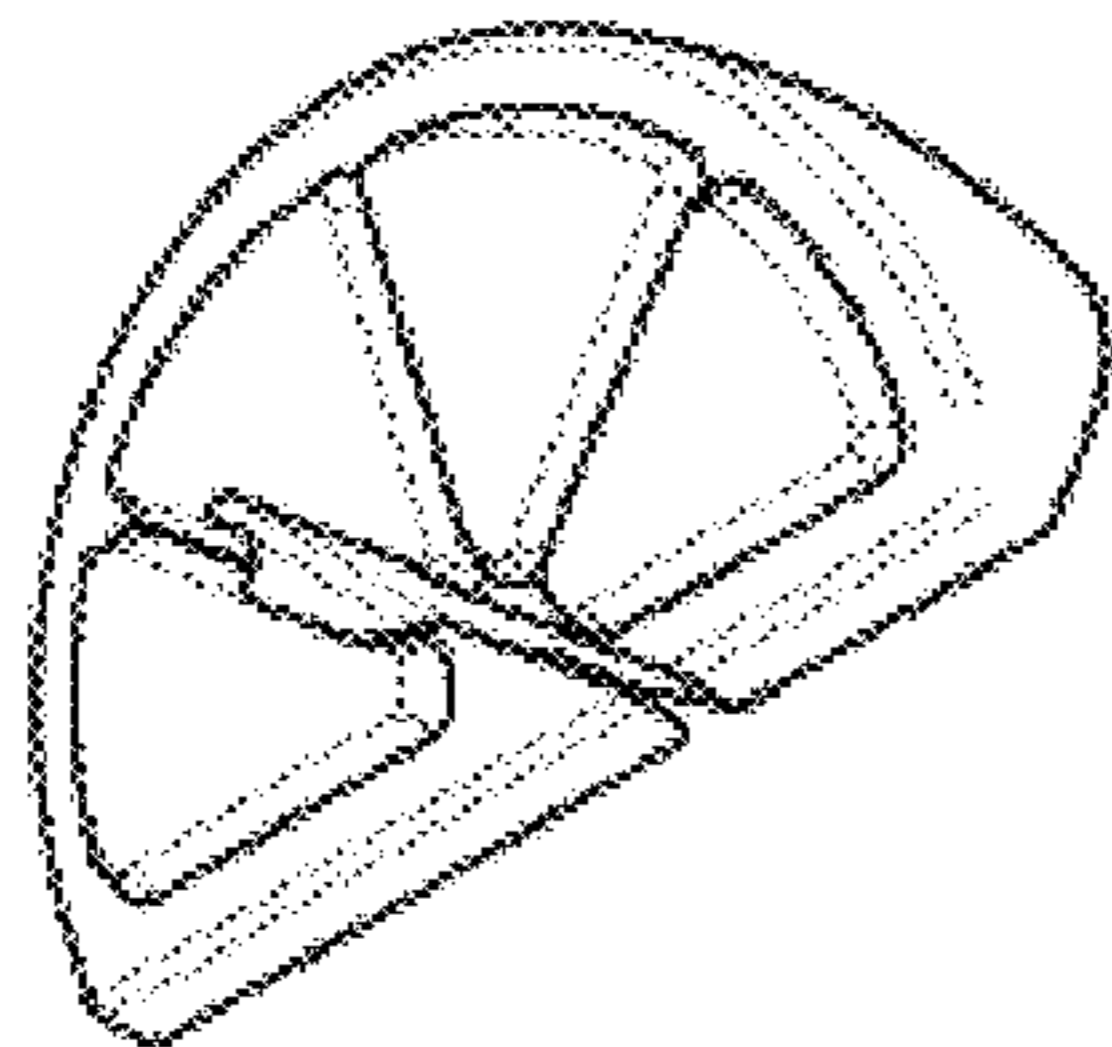

FIG. 6

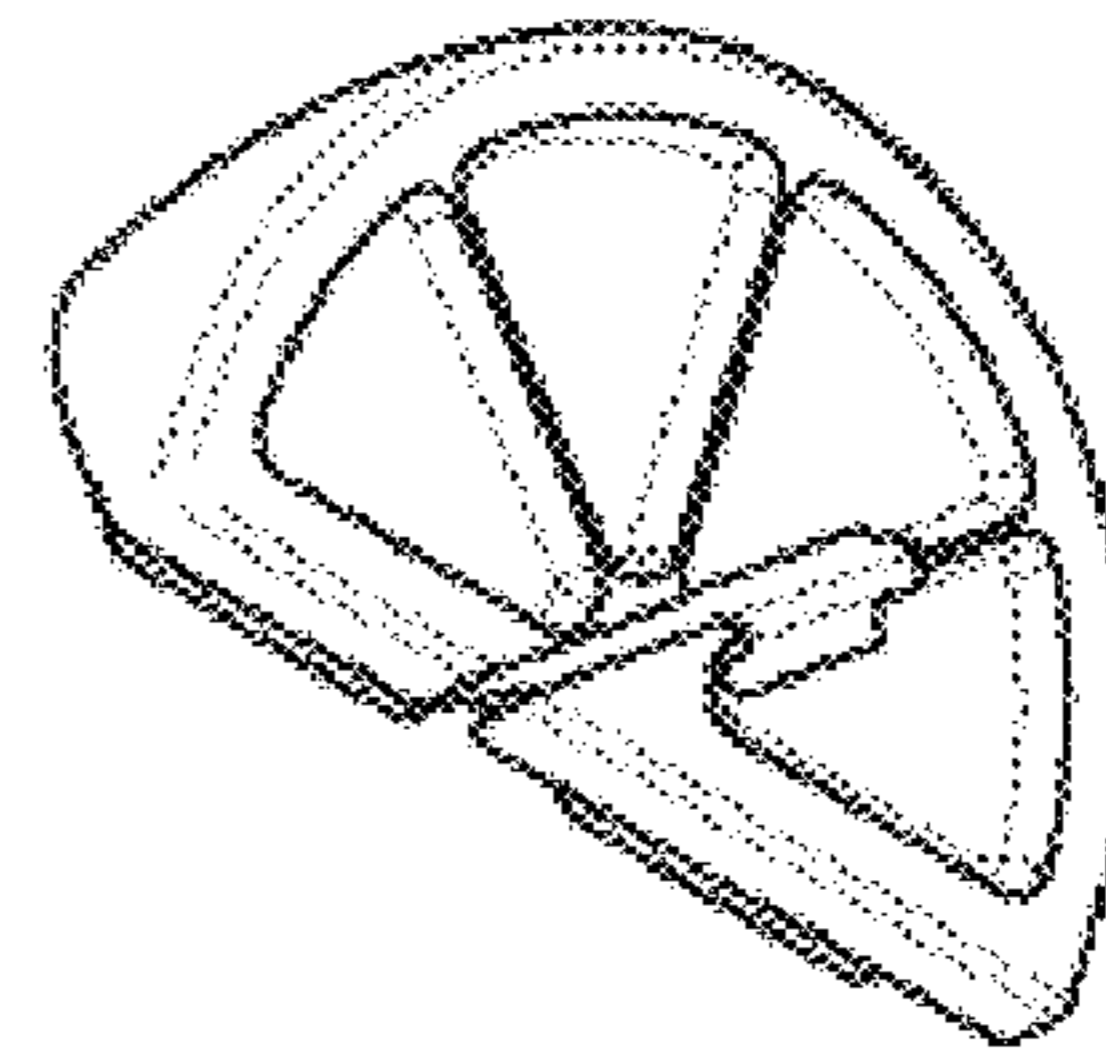

FIG. 7

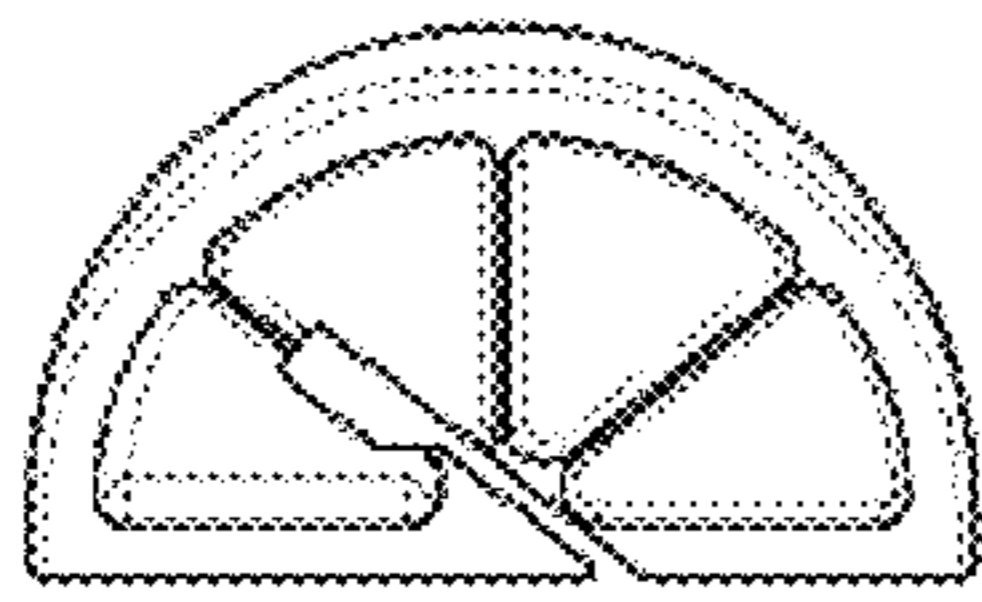

FIG. 8

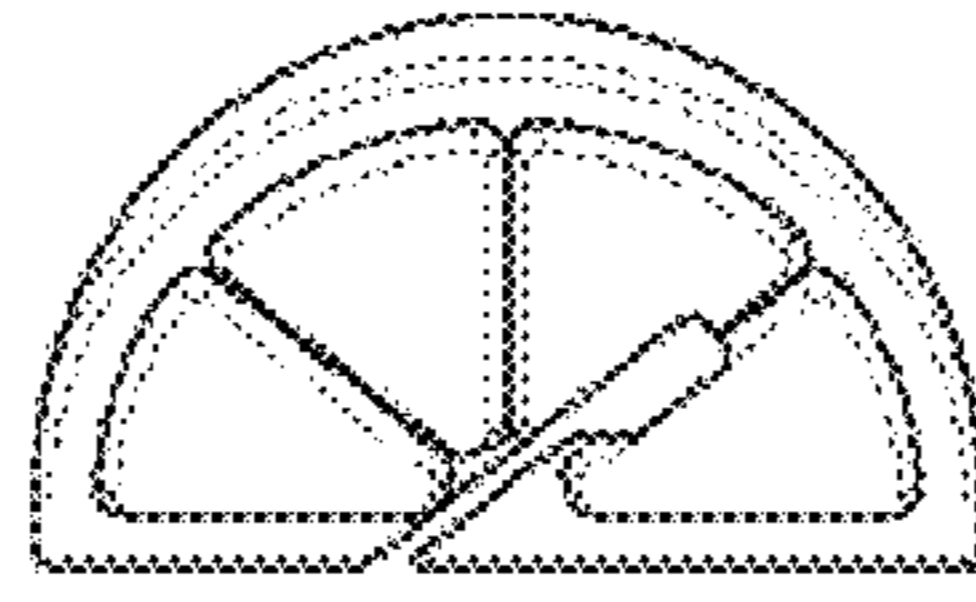

FIG. 9

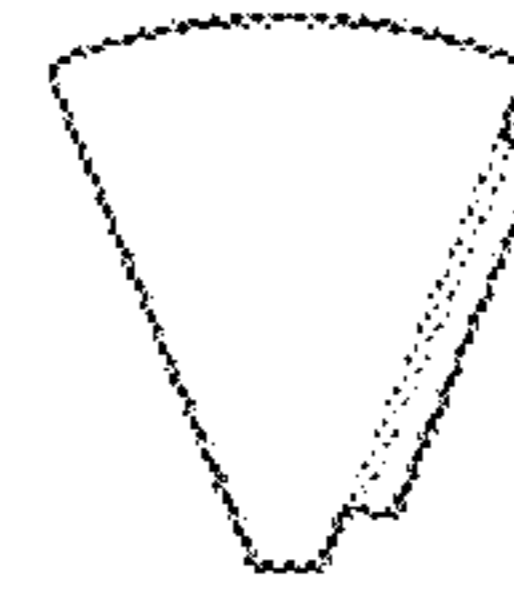

FIG. 10

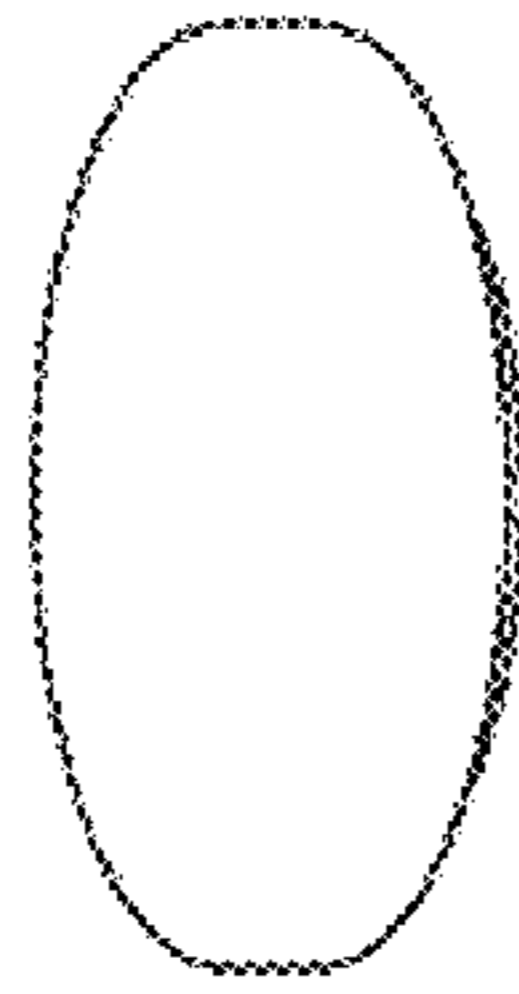

FIG. 11

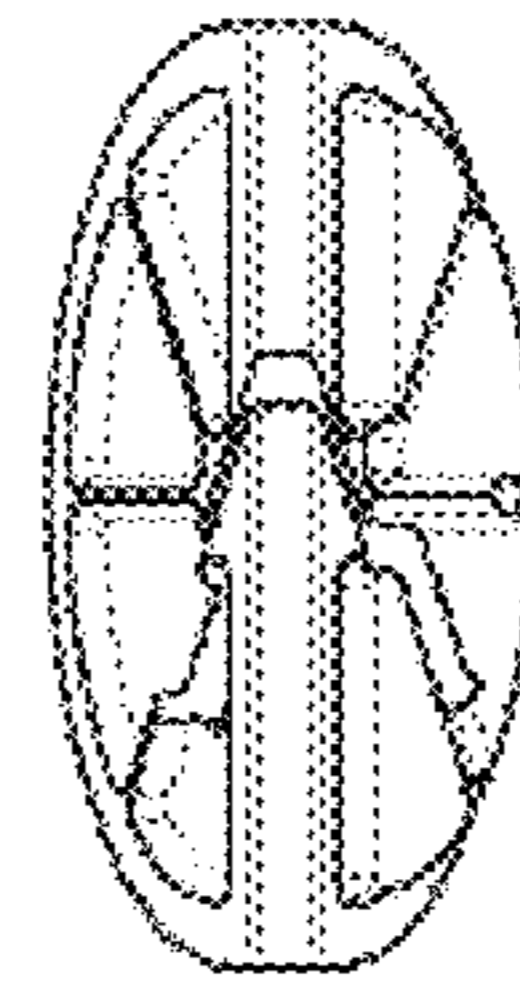

FIG. 12

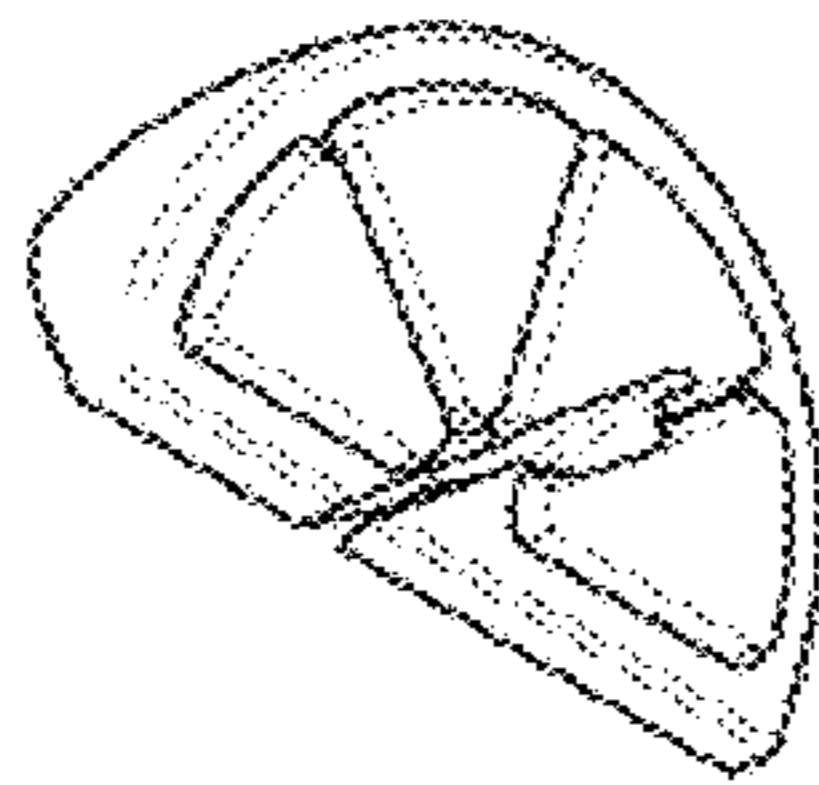

FIG. 13

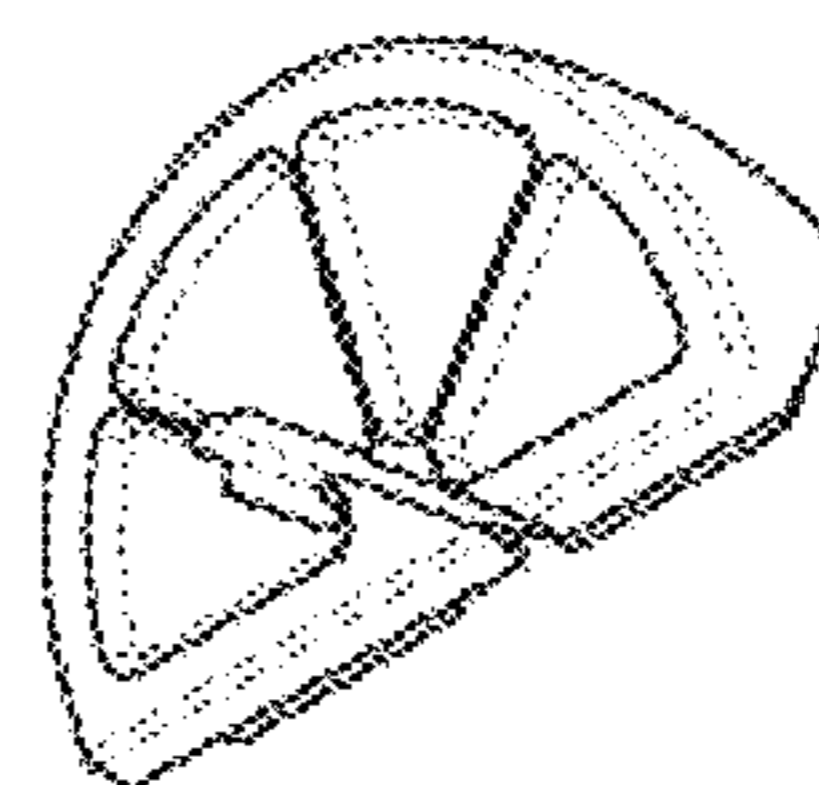

FIG. 14