



US00D799772S

(12) **United States Design Patent**
Choi

(10) **Patent No.:** **US D799,772 S**

(45) **Date of Patent:** **** Oct. 10, 2017**

(54) **UV STEAM IRON**

(71) Applicant: **Lung Wai Choi**, Hong Kong (HK)

(72) Inventor: **Lung Wai Choi**, Hong Kong (HK)

(**) Term: **15 Years**

(21) Appl. No.: **29/581,404**

(22) Filed: **Oct. 18, 2016**

(51) **LOC (10) Cl.** **07-05**

(52) **U.S. Cl.**
USPC **D32/70**

(58) **Field of Classification Search**
USPC D32/70, 71, 73, 72, 69, 68, 35; D8/71,
D8/373, 349, 396, 30; D15/144, 144.2;
D28/73; 219/231, 242, 229; 165/80.1;
126/414
CPC D06F 75/34; D06F 75/08; D06F 75/38;
D06F 75/00; F22B 27/14; B08B 3/006
See application file for complete search history.

(56) **References Cited**

U.S. PATENT DOCUMENTS

D629,989 S * 12/2010 Hollerich D32/70
D634,090 S * 3/2011 Massip D32/70

D645,629 S * 9/2011 Powell D32/70
D646,862 S * 10/2011 Choi D32/70
D668,413 S * 10/2012 Smith D32/70
D671,701 S * 11/2012 Tanoue D32/70
D676,209 S * 2/2013 Sirard D32/70
D743,662 S * 11/2015 Osborn D32/70
2008/0235998 A1 * 10/2008 Yeung H05B 3/265
38/93

* cited by examiner

Primary Examiner — Austin Murphy

(57) **CLAIM**

The ornamental design for an UV steam iron, as shown and described.

DESCRIPTION

FIG. 1 is a front elevational view of an UV steam iron showing my new design;
FIG. 2 is a rear elevational view thereof;
FIG. 3 is a left side view thereof;
FIG. 4 is a right side view thereof;
FIG. 5 is a top plan view thereof;
FIG. 6 is a bottom plan view thereof;
FIG. 7 is a first perspective view thereof;
FIG. 8 is a second perspective view thereof;
FIG. 9 is a third perspective view thereof; and,
FIG. 10 is fourth perspective view thereof.

1 Claim, 10 Drawing Sheets

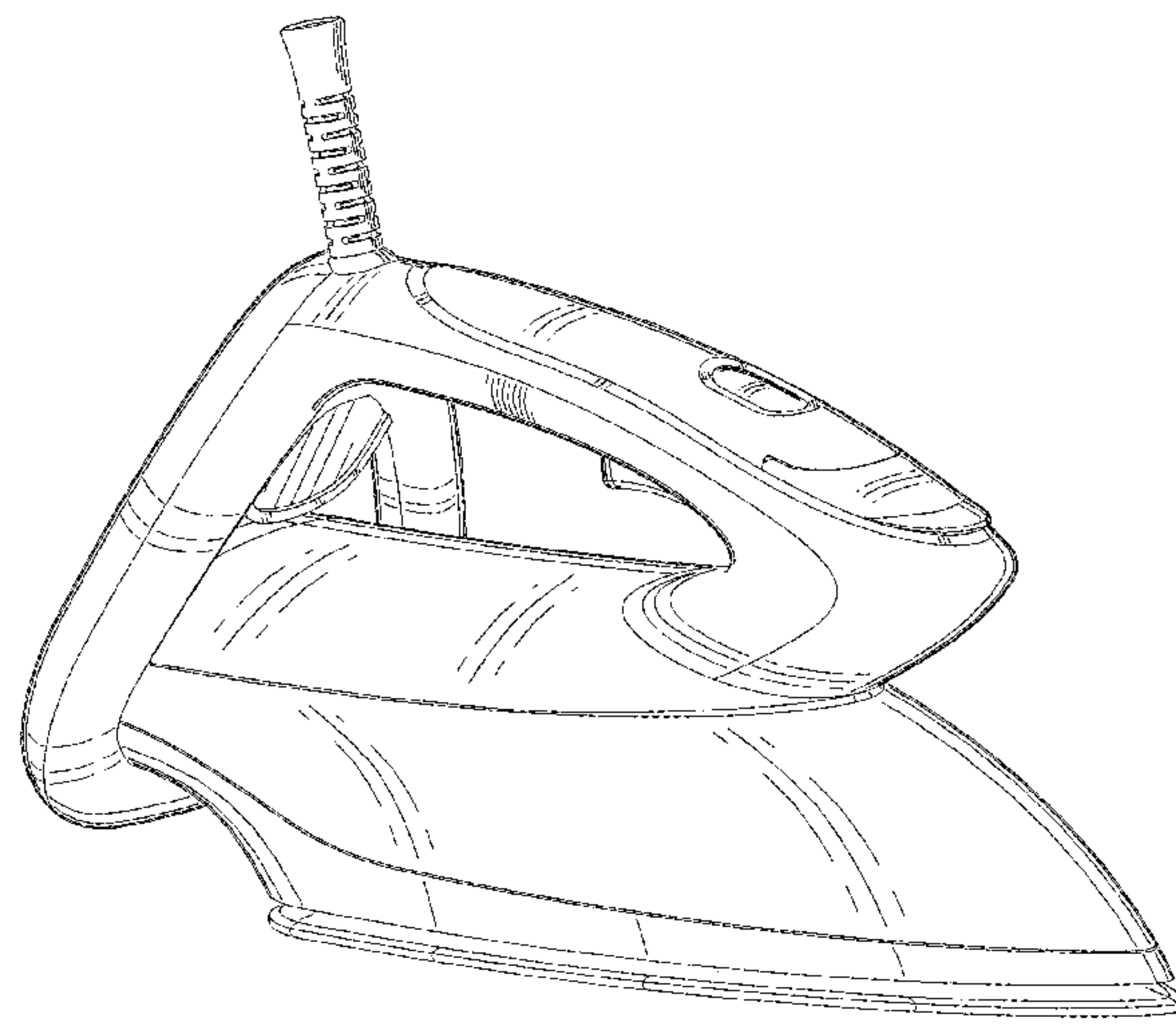
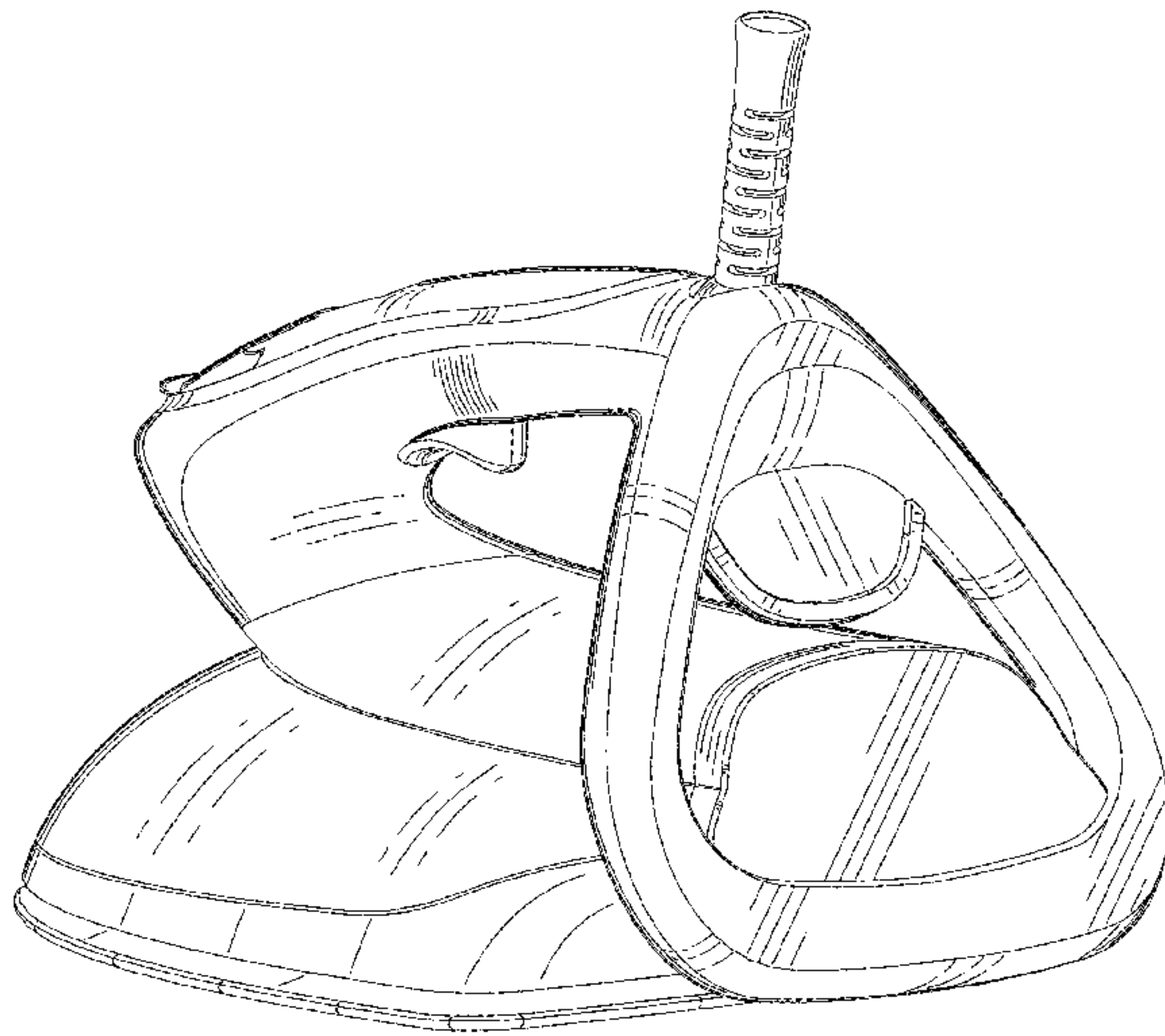

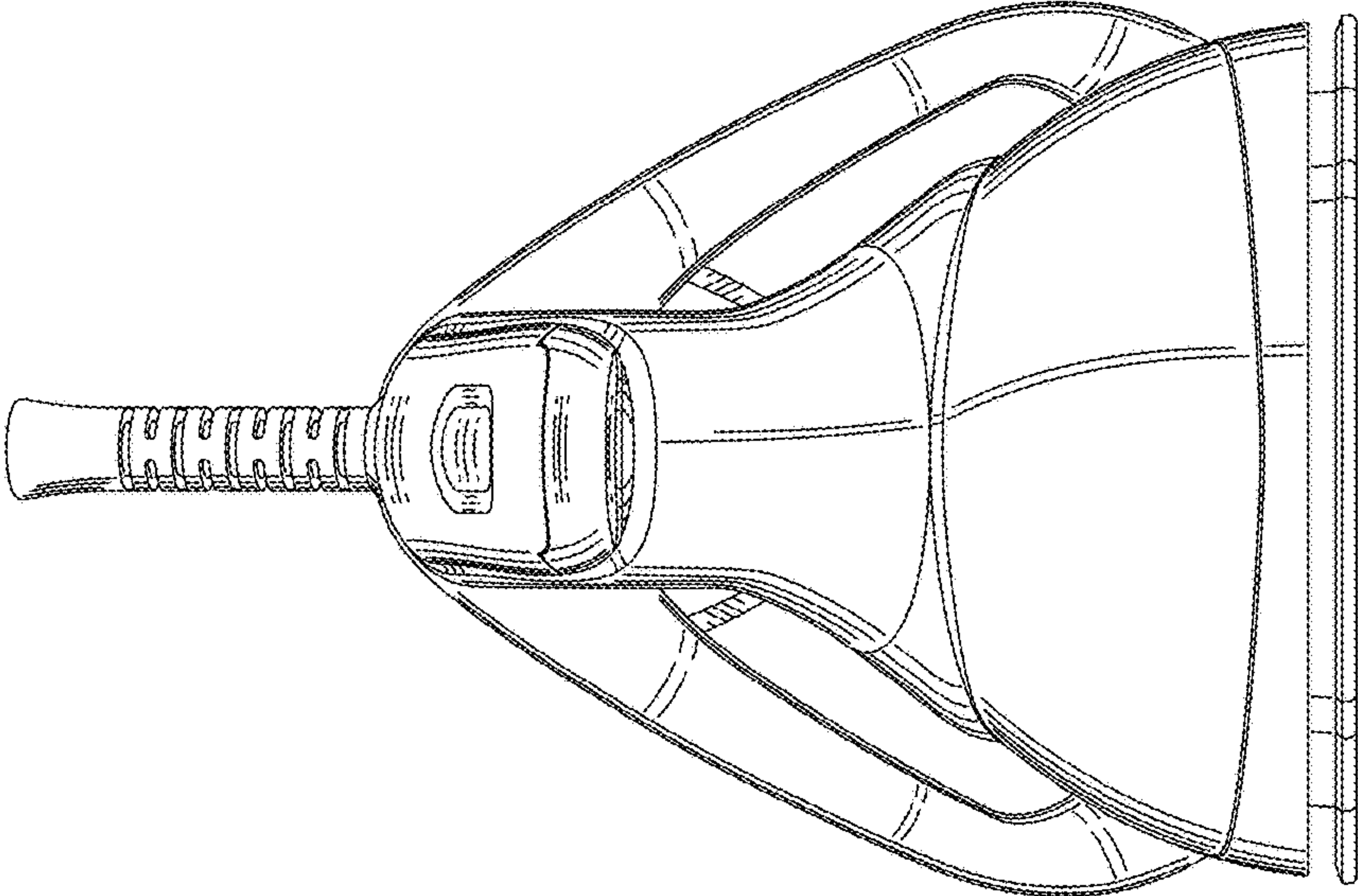

Fig. 1

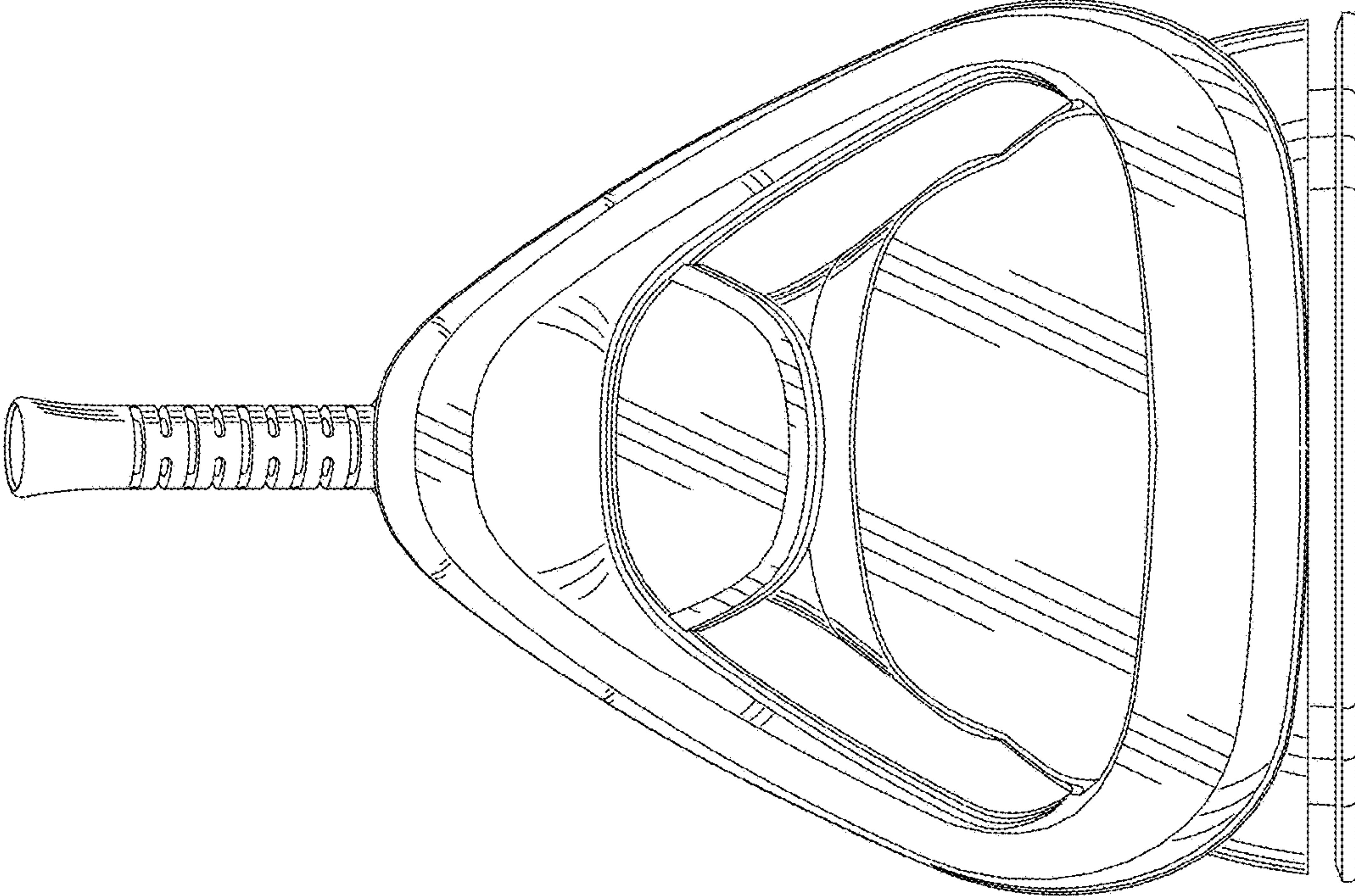

Fig. 2

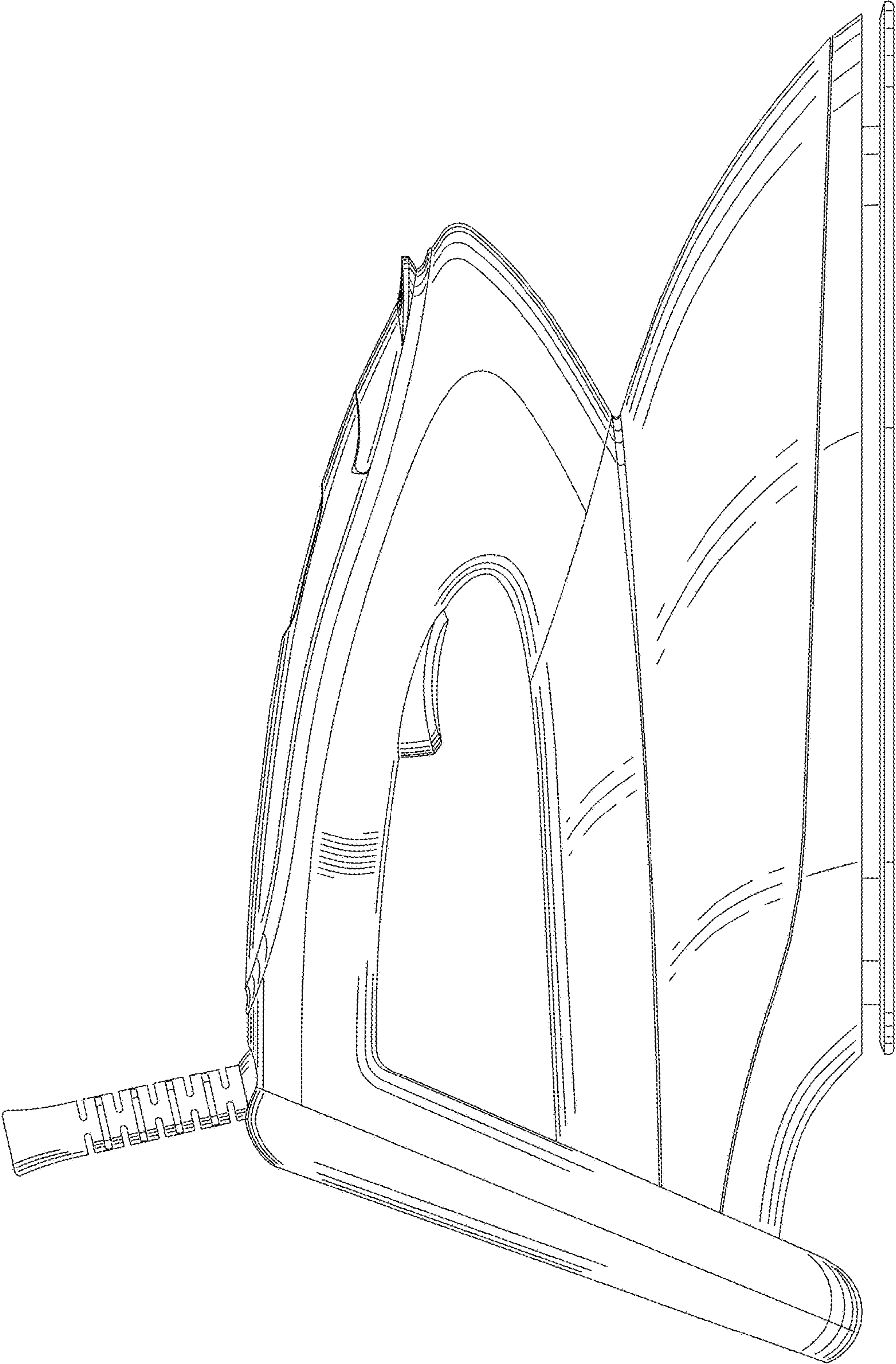

Fig. 3

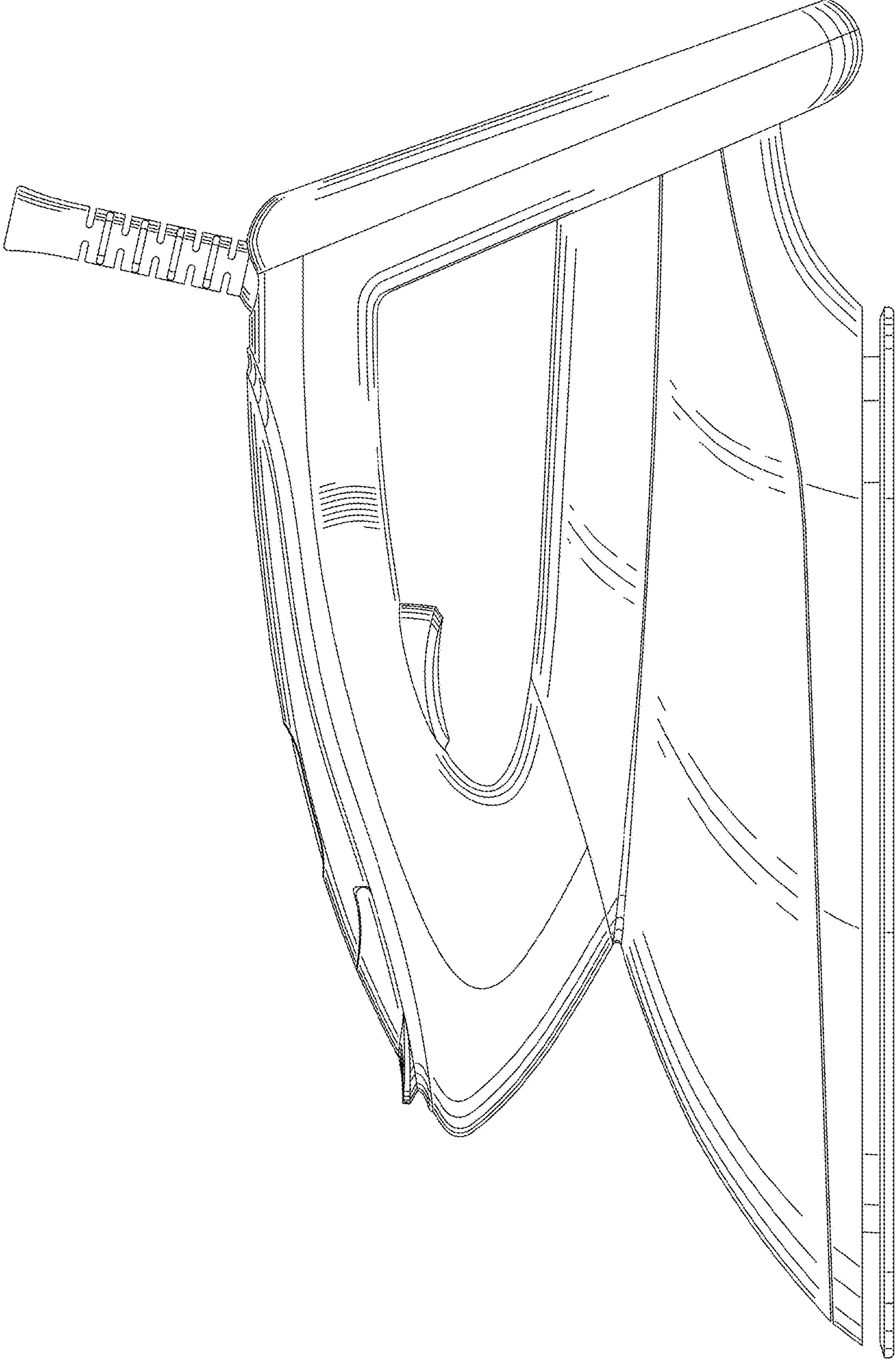

Fig. 4

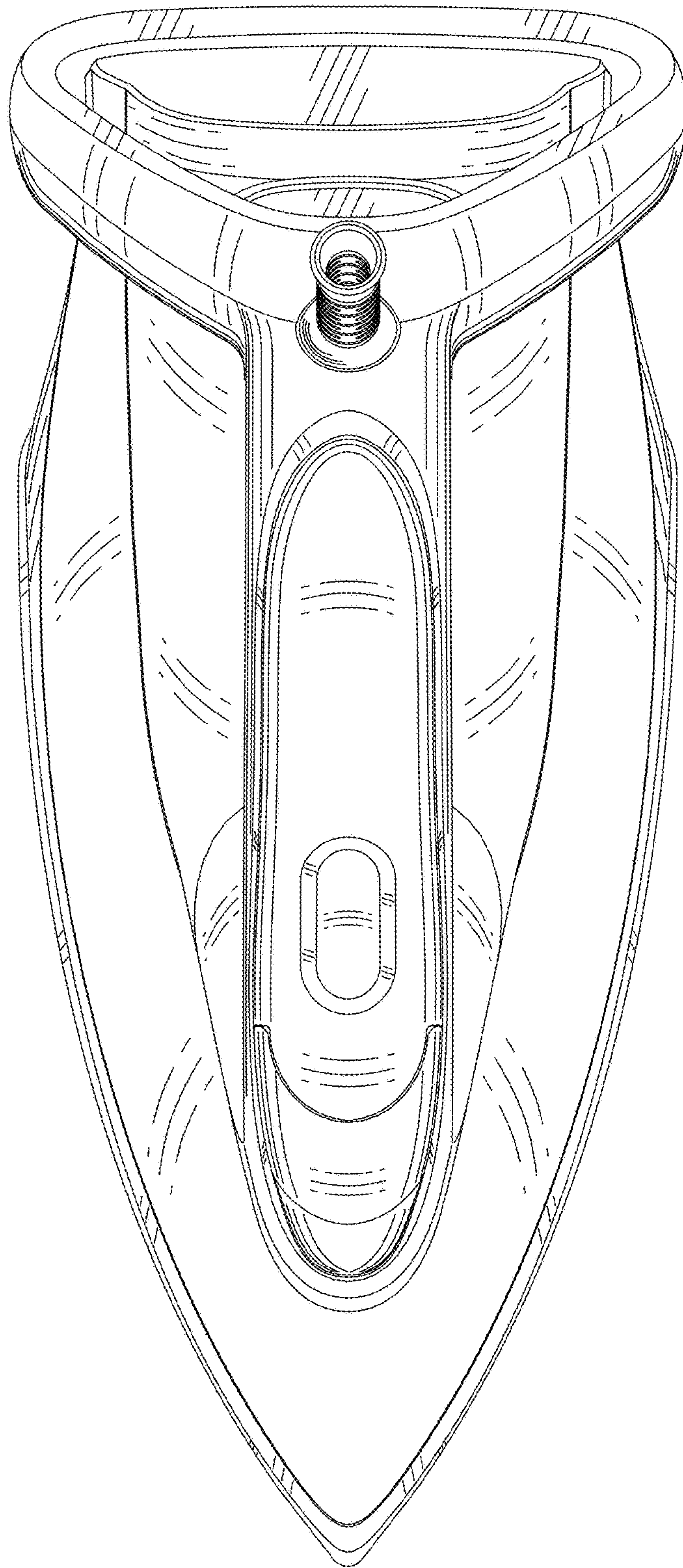

Fig. 5

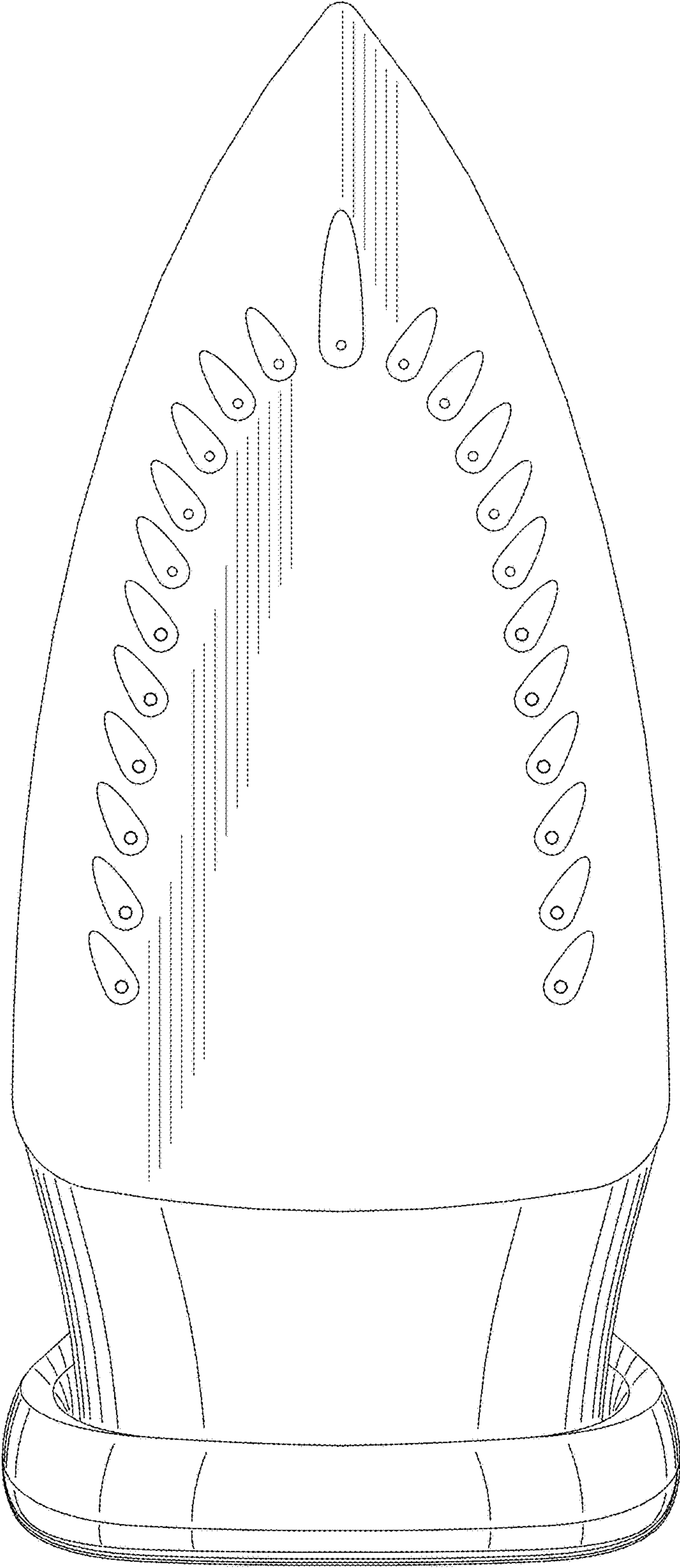

Fig. 6

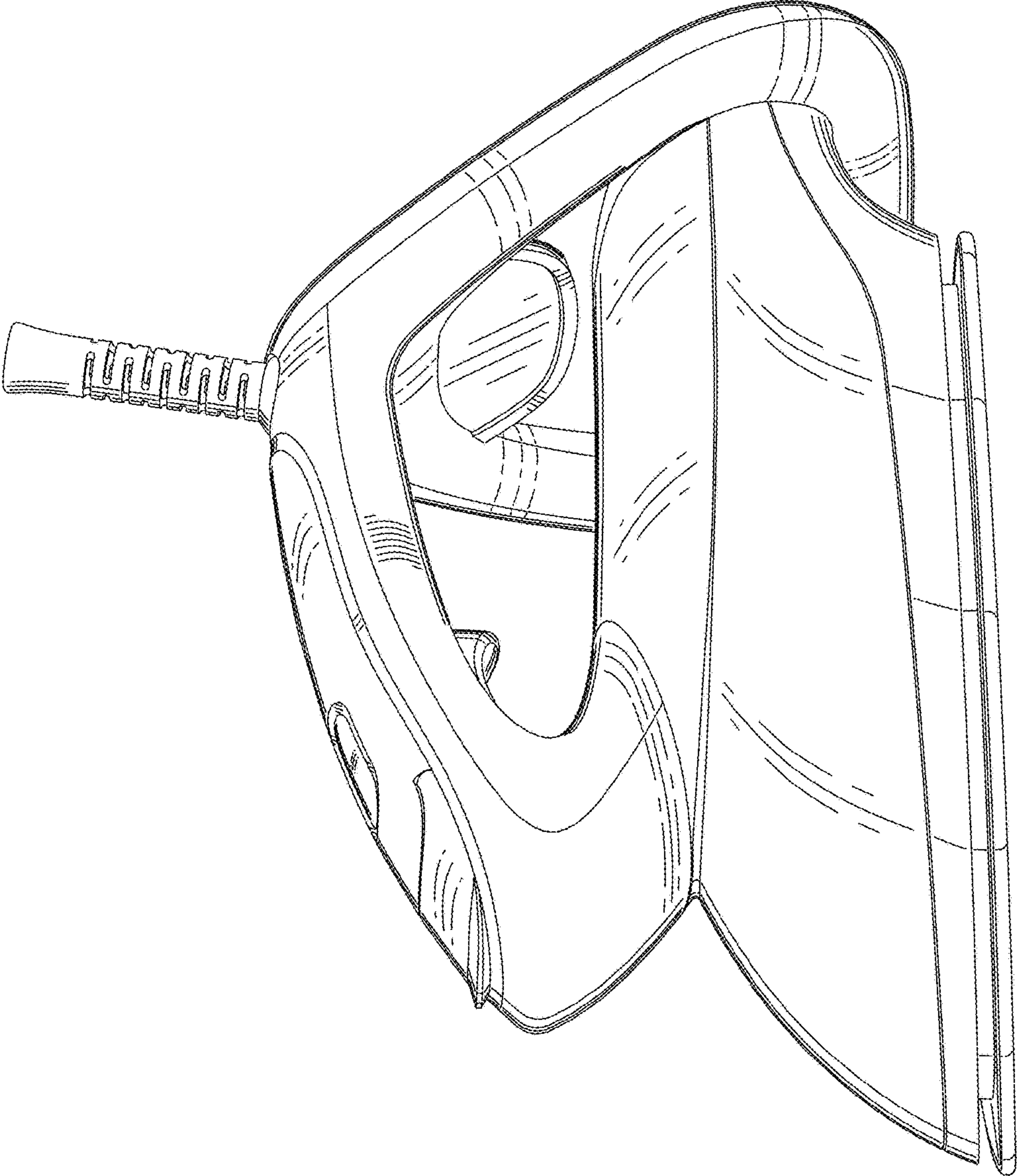

Fig. 7

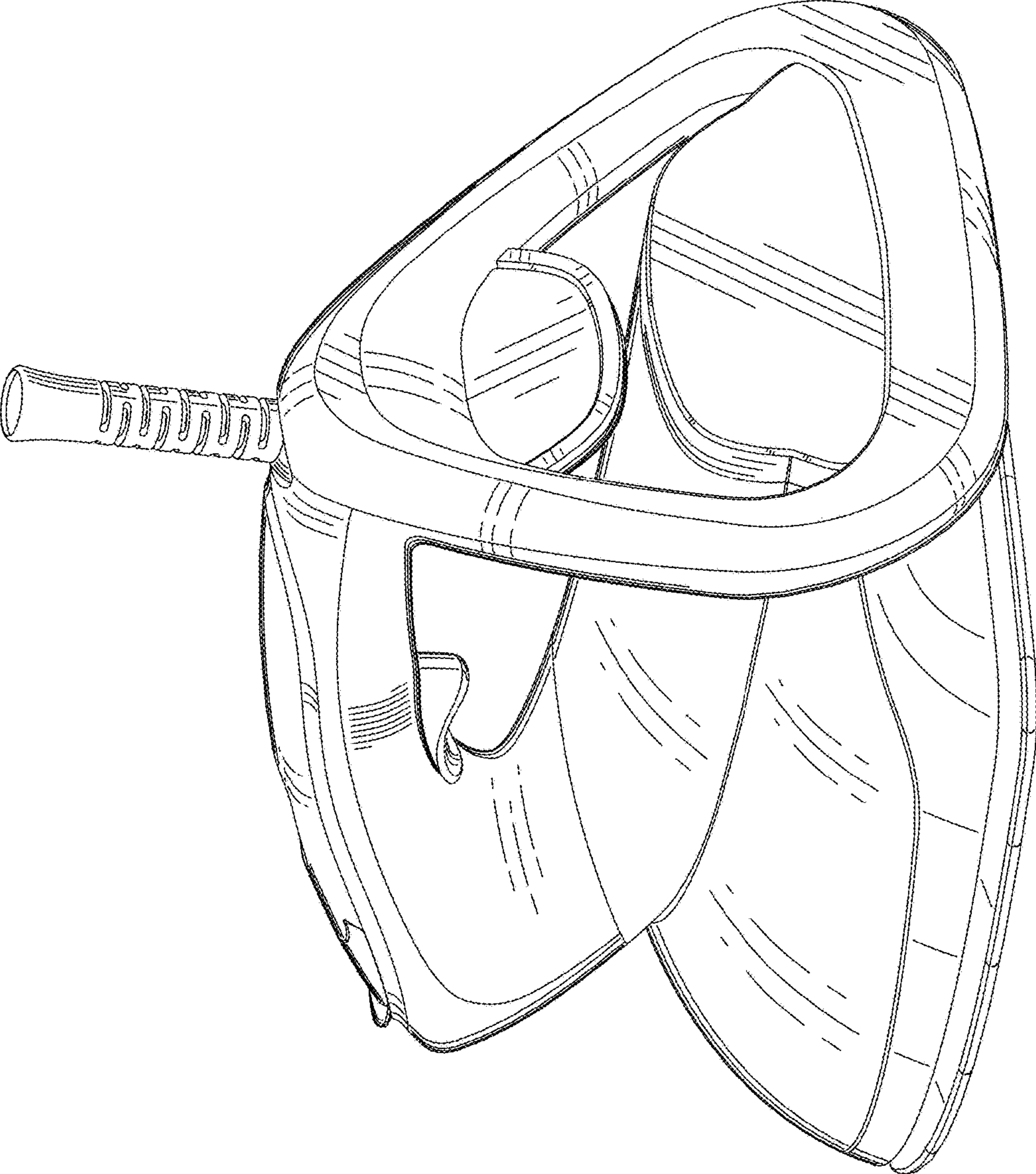

Fig. 8

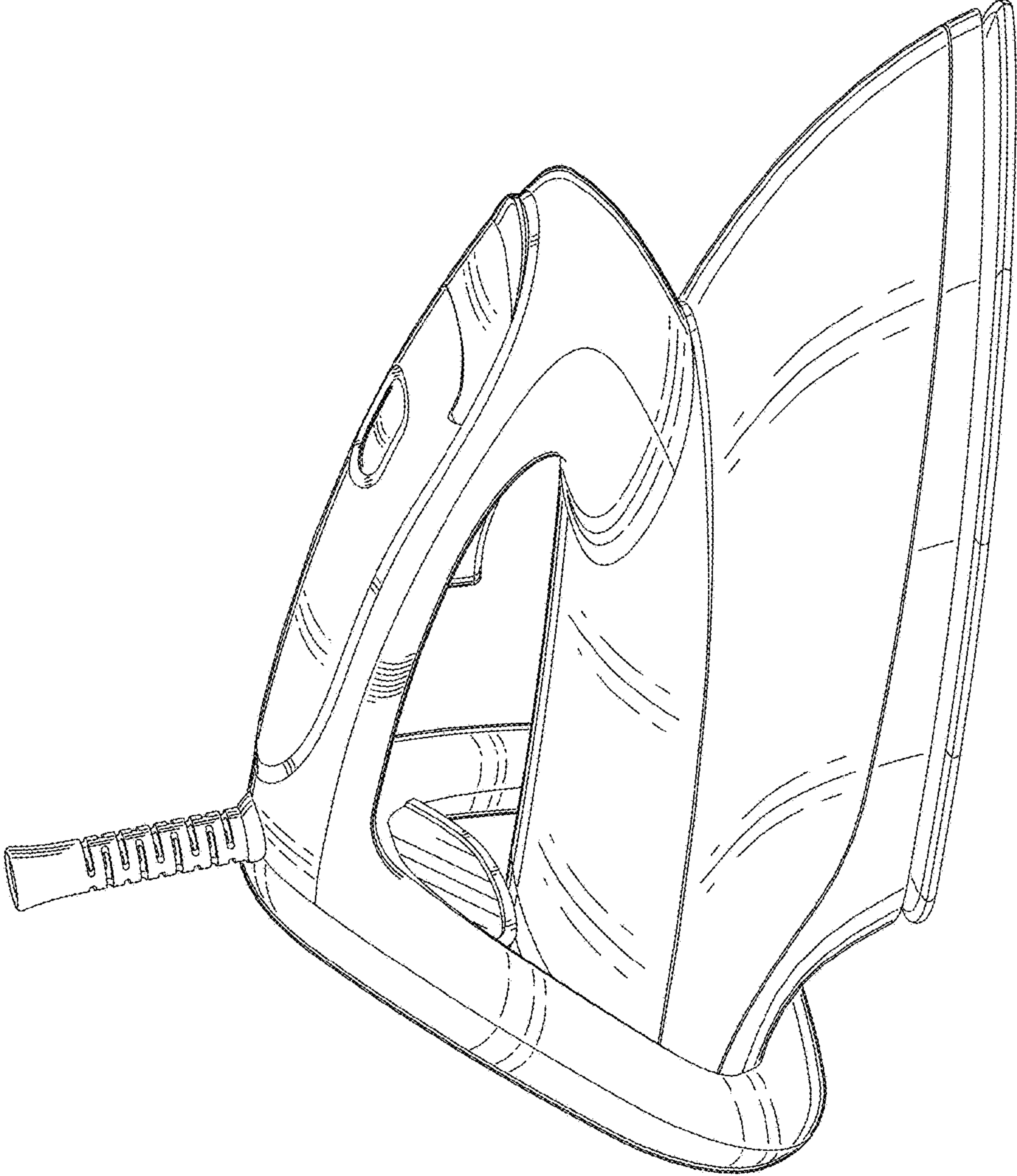

Fig. 9

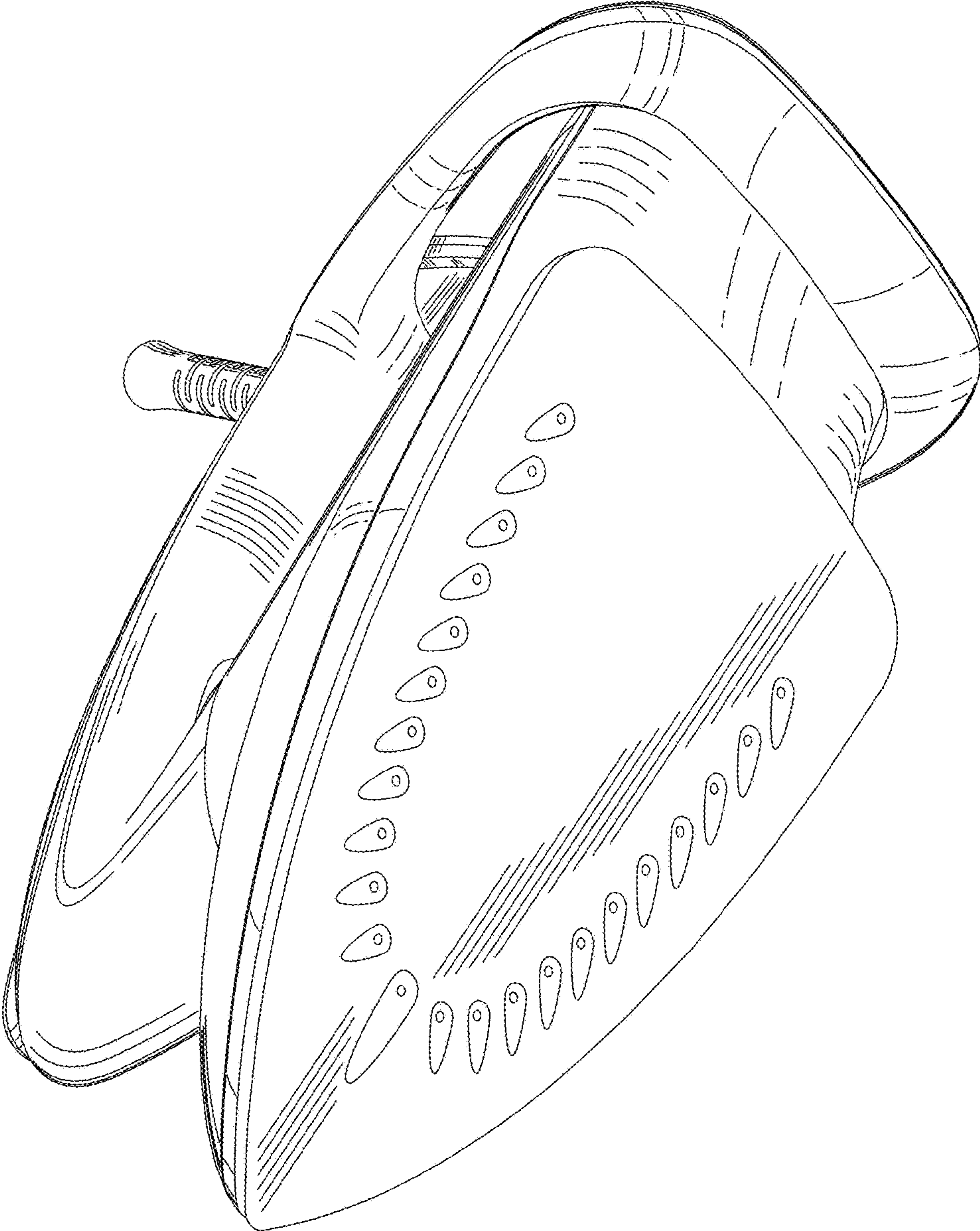

Fig. 10