



US00D799694S

(12) **United States Design Patent**
Mori et al.

(10) **Patent No.:** **US D799,694 S**
(45) **Date of Patent:** **** Oct. 10, 2017**

(54) **MOXIBUSTION INSTRUMENT**
(71) Applicant: **MURATA MANUFACTURING CO., LTD.**, Kyoto (JP)
(72) Inventors: **Taichi Mori**, Nagaokakyo (JP);
Yoshitaka Hane, Nagaokakyo (JP);
Rieko Ogura, Nagaokakyo (JP)
(**) Term: **15 Years**

(21) Appl. No.: **35/500,963**
(22) Filed: **Nov. 19, 2015**

(80) **Hague Agreement Data**
Int. Filing Date: **Nov. 19, 2015**
Int. Reg. No.: **DM/088859**
Int. Reg. Date: **Nov. 19, 2015**
Int. Reg. Pub. Date: **May 20, 2016**

(30) **Foreign Application Priority Data**
May 28, 2015 (JP) 2015-011862
May 28, 2015 (JP) 2015-011863

(51) **LOC (10) Cl.** **24-00**
(52) **U.S. Cl.**
USPC **D24/133**

(58) **Field of Classification Search**
USPC D24/133, 186, 206, 172, 187, 158, 146,
D24/113, 147, 215; D8/14; D28/58;
601/121; 128/907; 606/204
CPC A61H 39/04; A61N 1/36021; A61F 7/02
See application file for complete search history.

(56) **References Cited**
U.S. PATENT DOCUMENTS
4,122,852 A * 10/1978 Knetsch A61H 39/04
606/204
4,763,657 A * 8/1988 Chen A61N 1/36021
128/907
D363,129 S * 10/1995 Landers D24/200

D363,994 S * 11/1995 Cheng D24/215
6,793,636 B1 * 9/2004 Pepera A61F 7/02
601/121
D616,992 S * 6/2010 Kitayama D24/186
D650,909 S * 12/2011 Anderson D24/206
D695,408 S * 12/2013 Bott D24/172
D701,606 S * 3/2014 Ohmukai D24/187
D702,358 S * 4/2014 Shinohara D24/187

(Continued)

Primary Examiner — Rhea Shields

(57) **CLAIM**

The ornamental design for a moxibustion instrument, as shown and described.

DESCRIPTION

- 1.-2. Moxibustion instrument
- 1.1 is a front view;
- 1.2 is a back view;
- 1.3 is a top view;
- 1.4 is bottom view;
- 1.5 is a right side view;
- 1.6 is left side view;
- 1.7 is perspective view;
- 1.8 is a perspective view;
- 1.9 is a perspective view; and
- 1.10 is a perspective view.
- 2.1 is a front view;
- 2.2 is a back view;
- 2.3 is a top view;
- 2.4 is bottom view;
- 2.5 is a right side view;
- 2.6 is left side view;
- 2.7 is perspective view;
- 2.8 is a perspective view;
- 2.9 is a perspective view; and
- 2.10 is a perspective view.

The alternating dot and dash lines represent the bounds of the claim, and all other broken lines are included for the purpose of illustrating unclaimed portions of the moxibustion instrument.

1 Claim, 20 Drawing Sheets

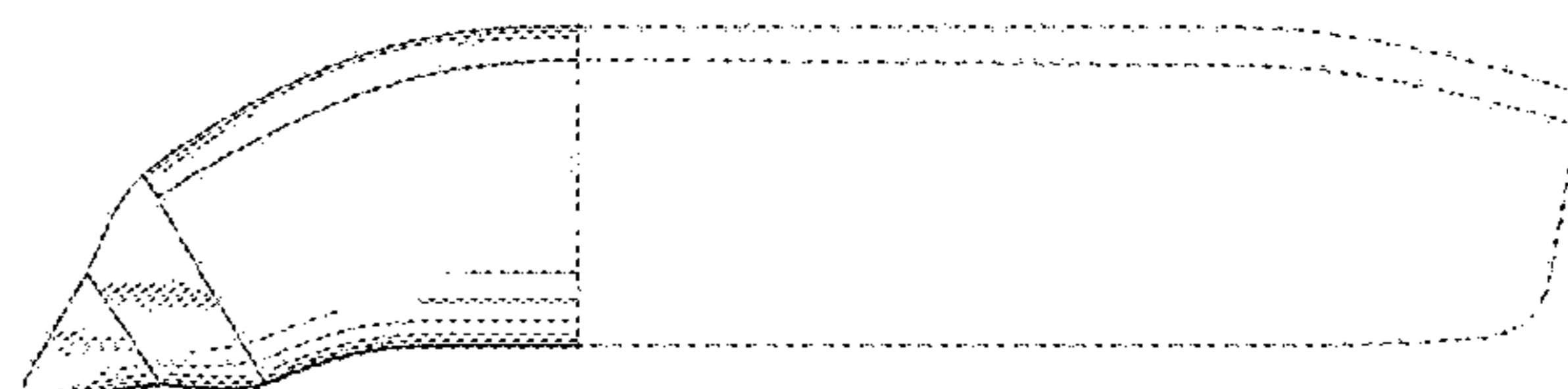
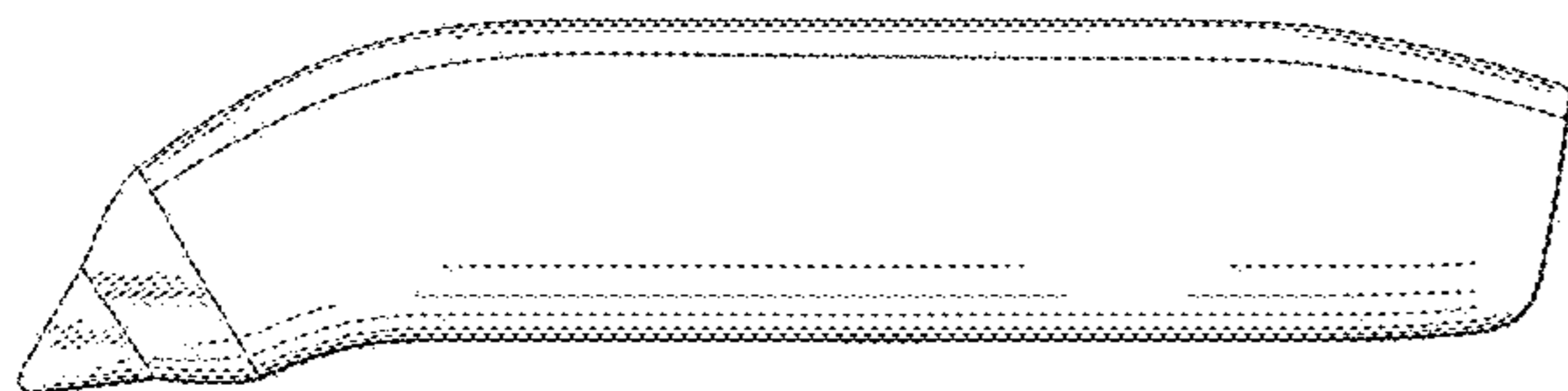

(56)

References Cited

U.S. PATENT DOCUMENTS

D703,331 S *	4/2014	Kitayama	D24/187
D724,726 S *	3/2015	Prokop	D24/133
D734,479 S *	7/2015	Youngquist	D24/158
D744,309 S *	12/2015	Rose	D8/14
D749,731 S *	2/2016	Wegener	D24/146
D764,657 S *	8/2016	Bokelman	D24/113
D781,497 S *	3/2017	Butler	D28/58
D785,796 S *	5/2017	Efinger	D24/147
D786,423 S *	5/2017	Jones	D24/113

* cited by examiner

1.1

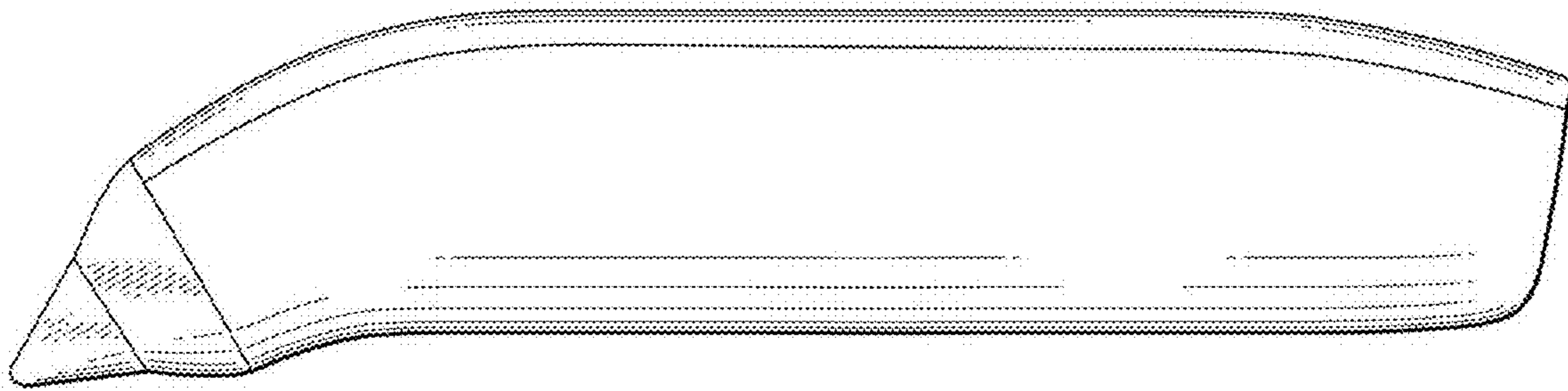

1.2

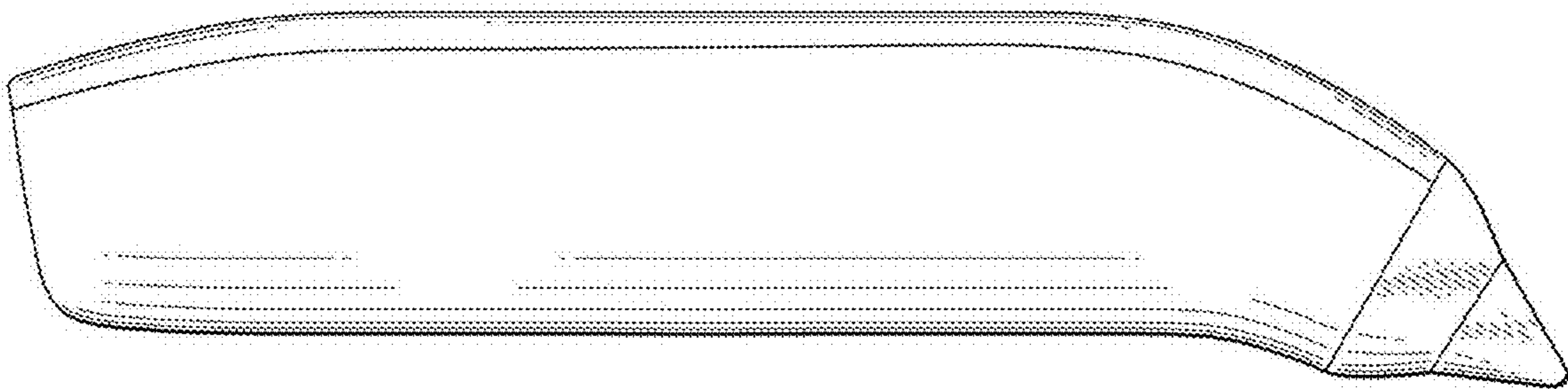

1.3

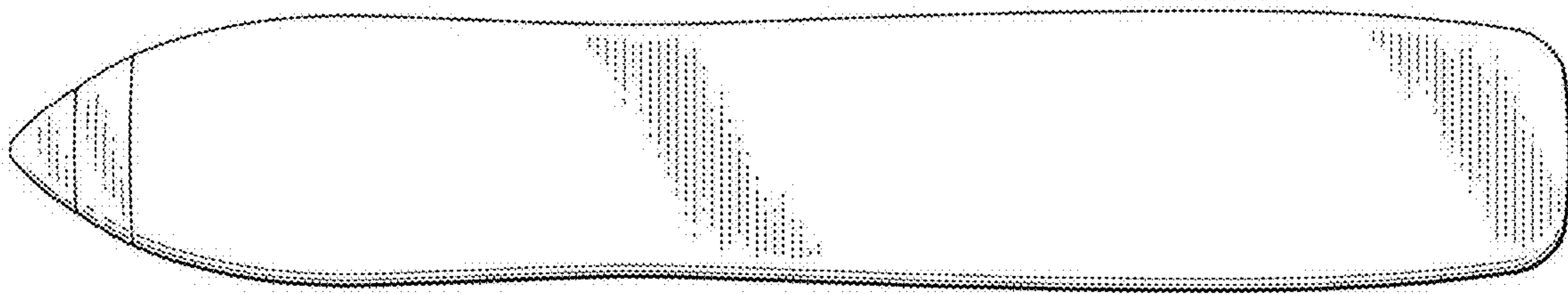

1.4

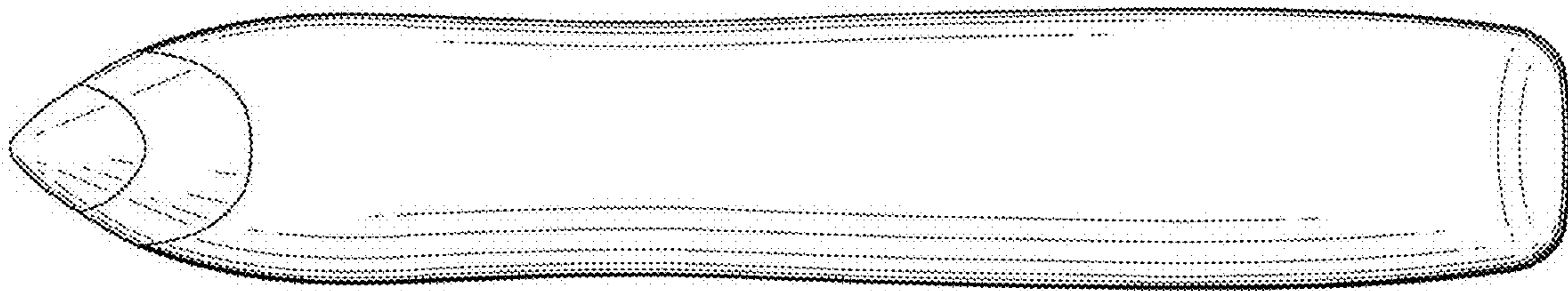

1.5

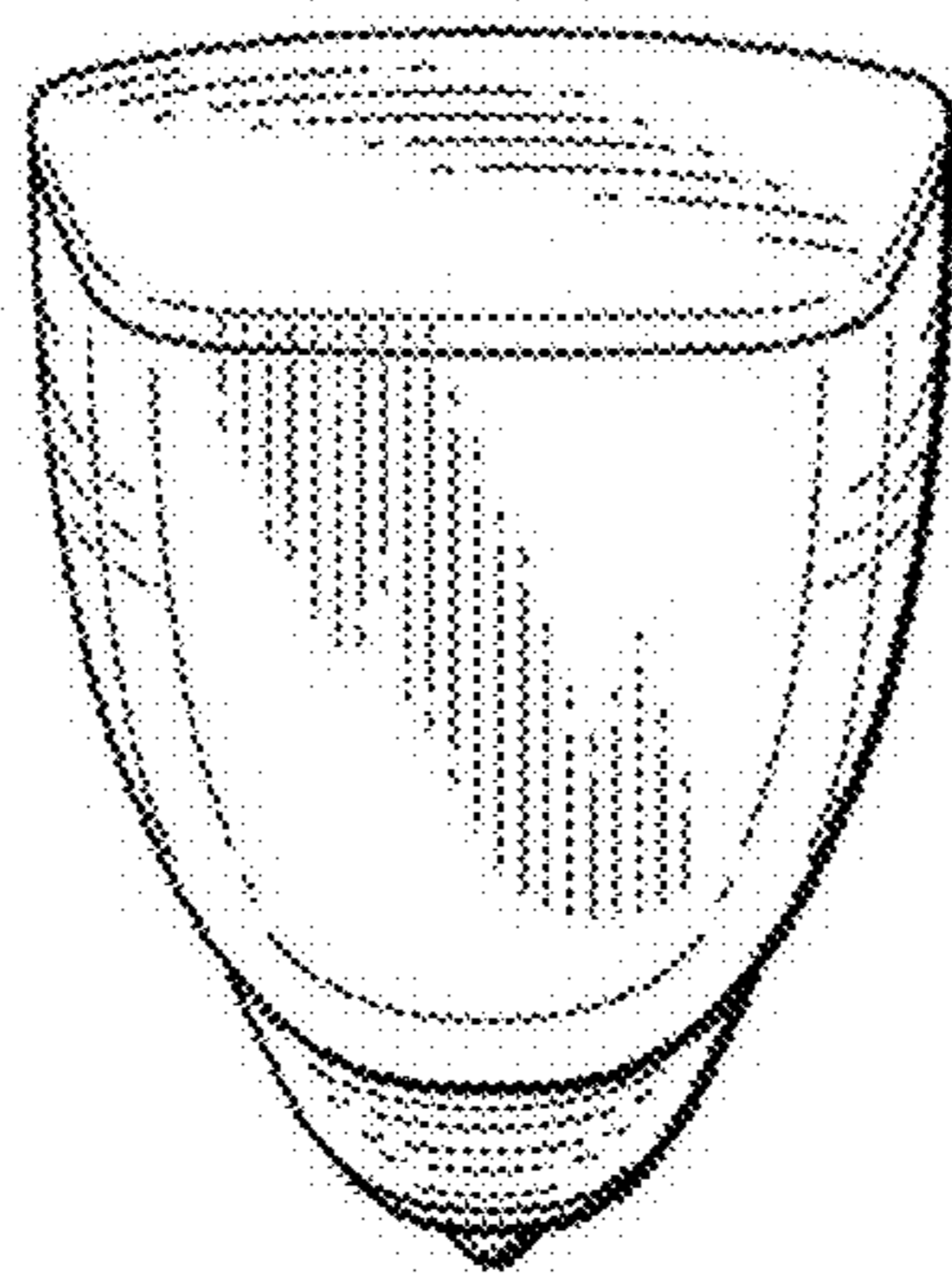

1.6

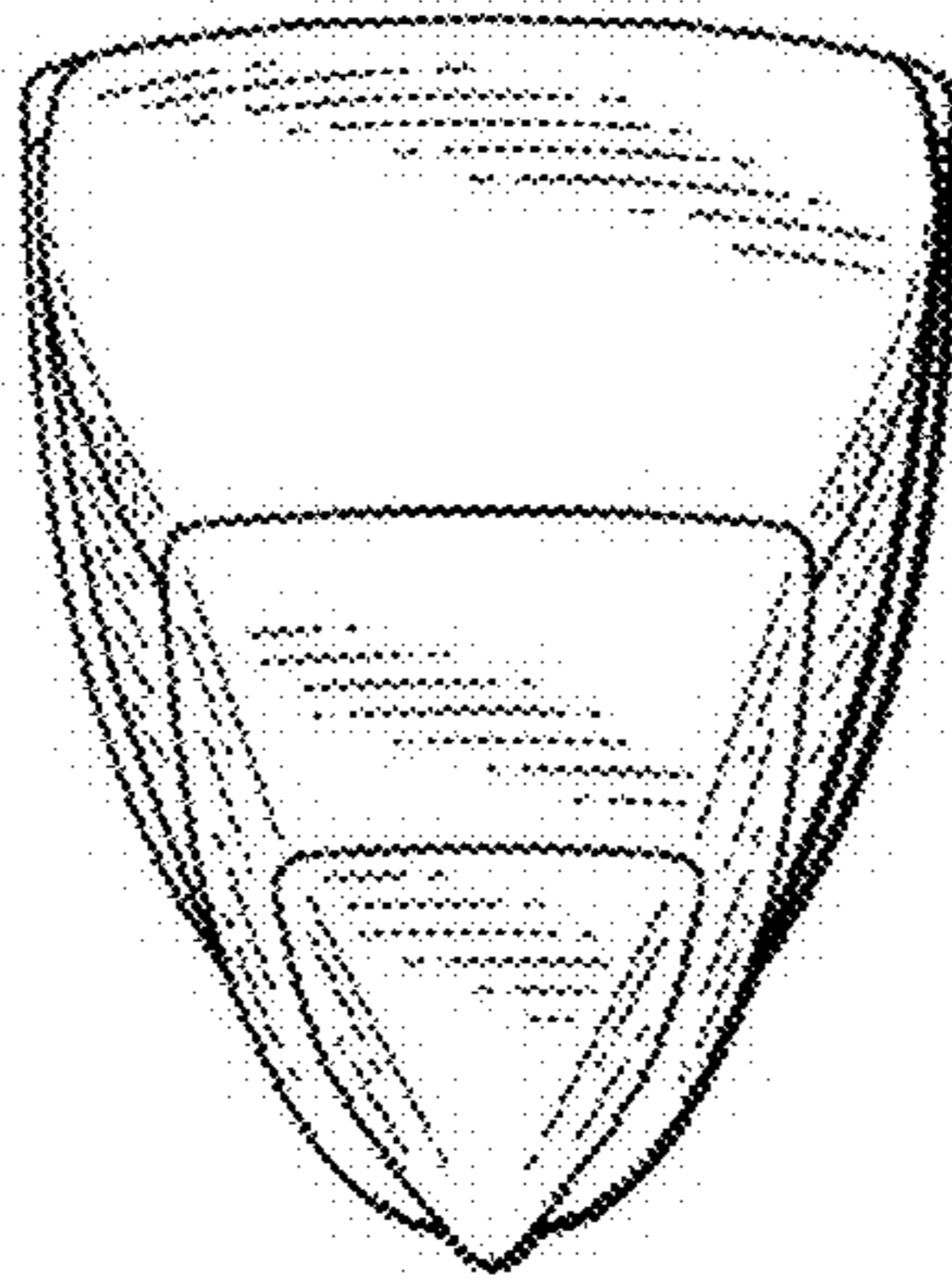

1.7

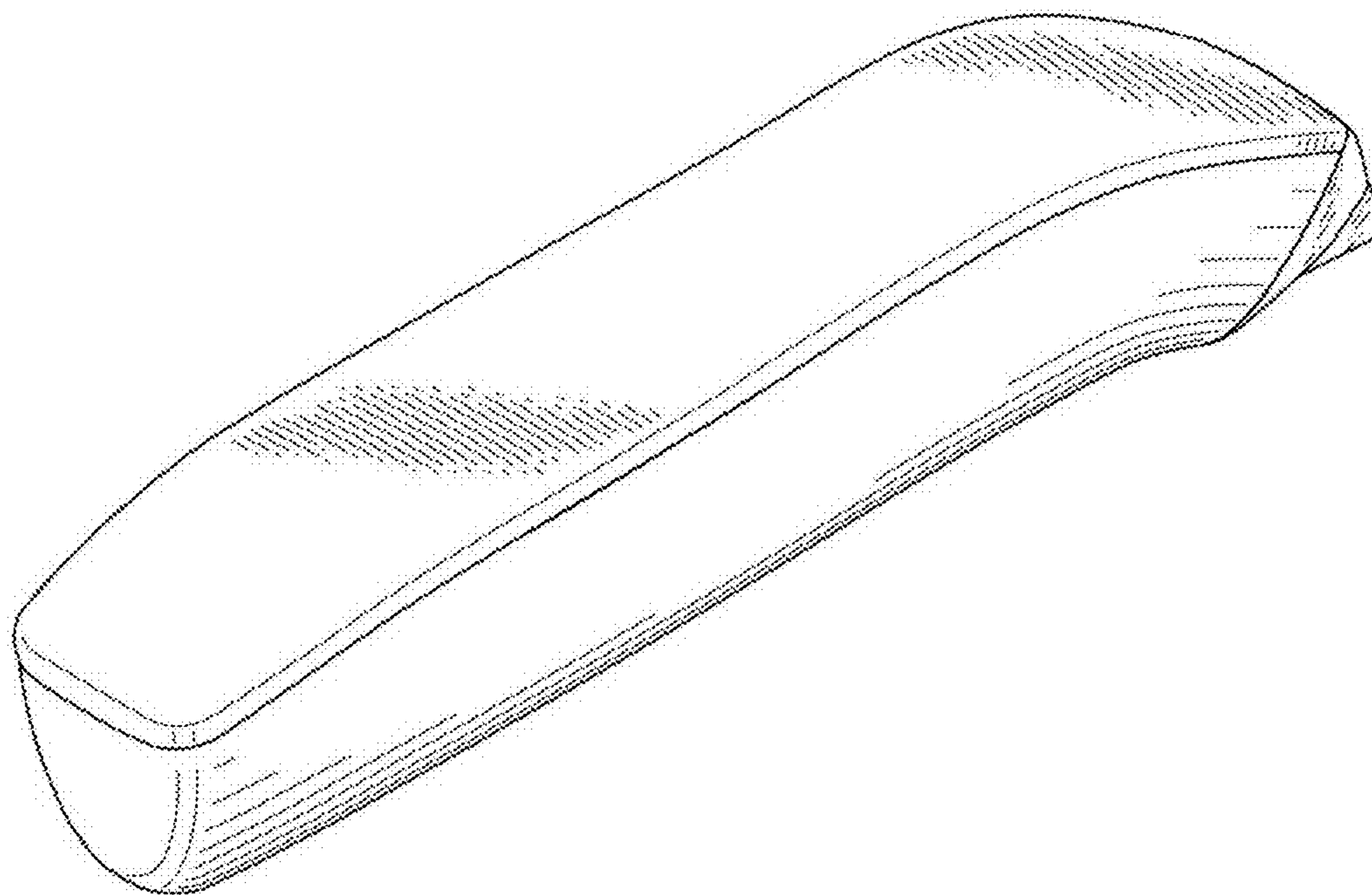

1.8

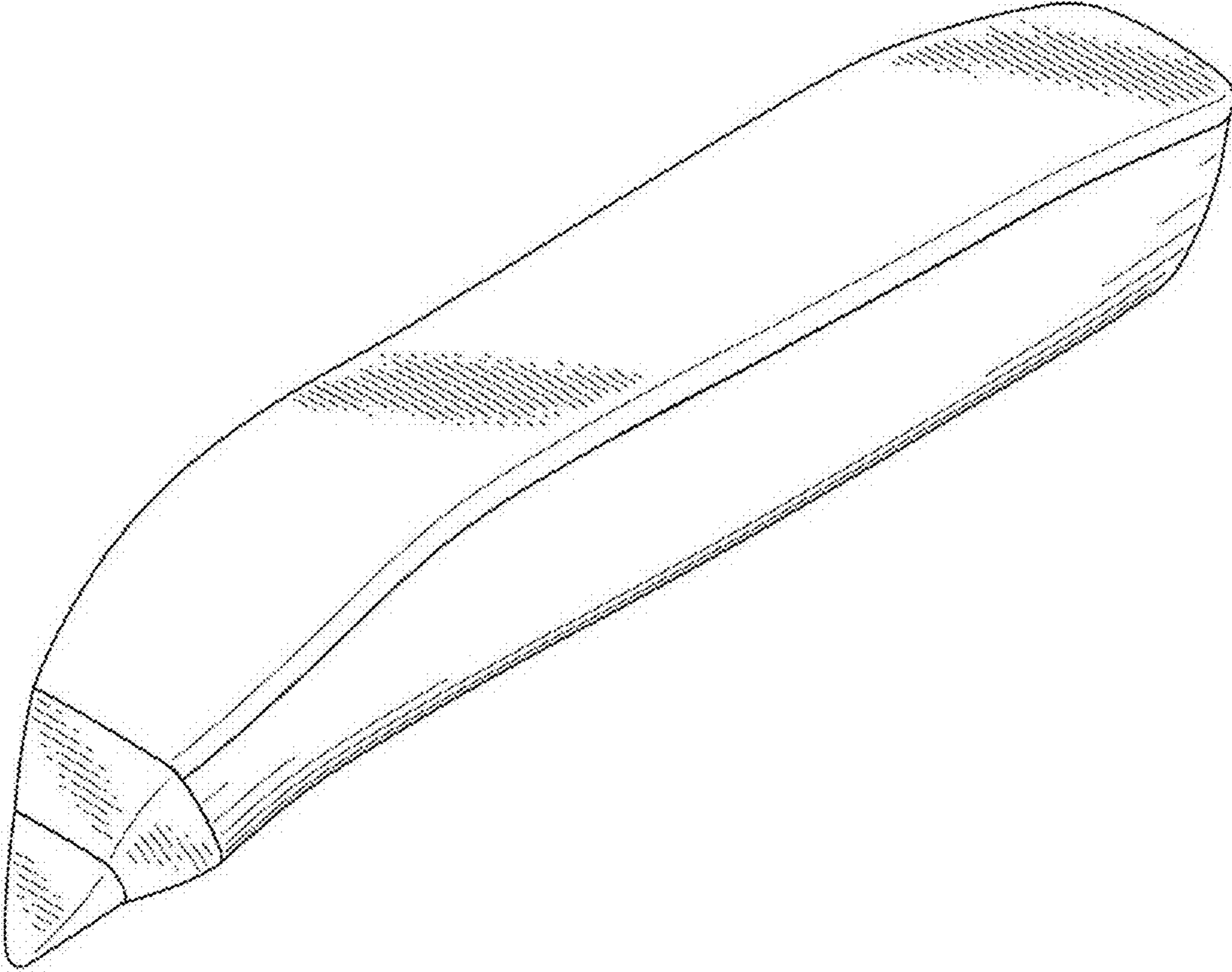

1.9

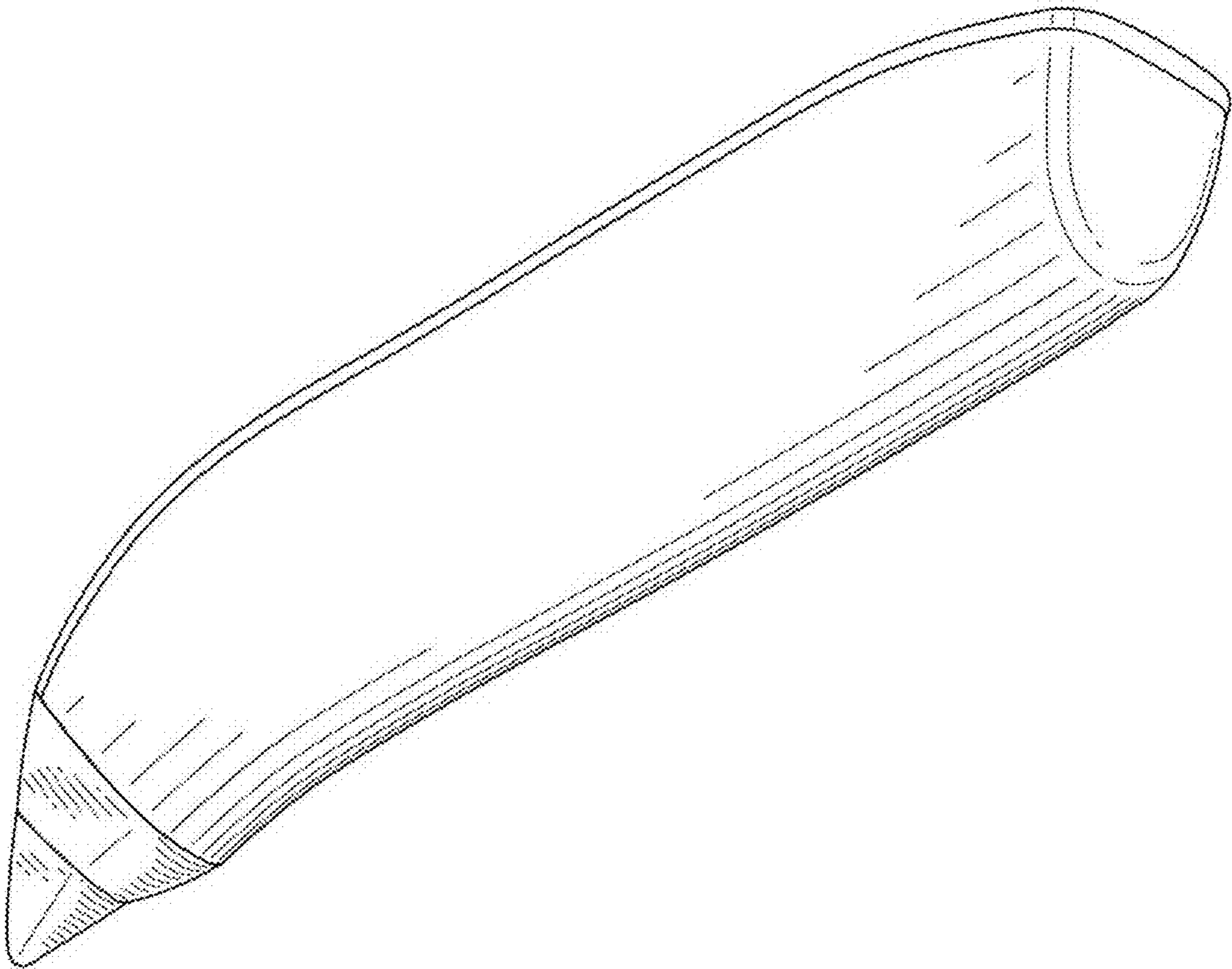

1.10

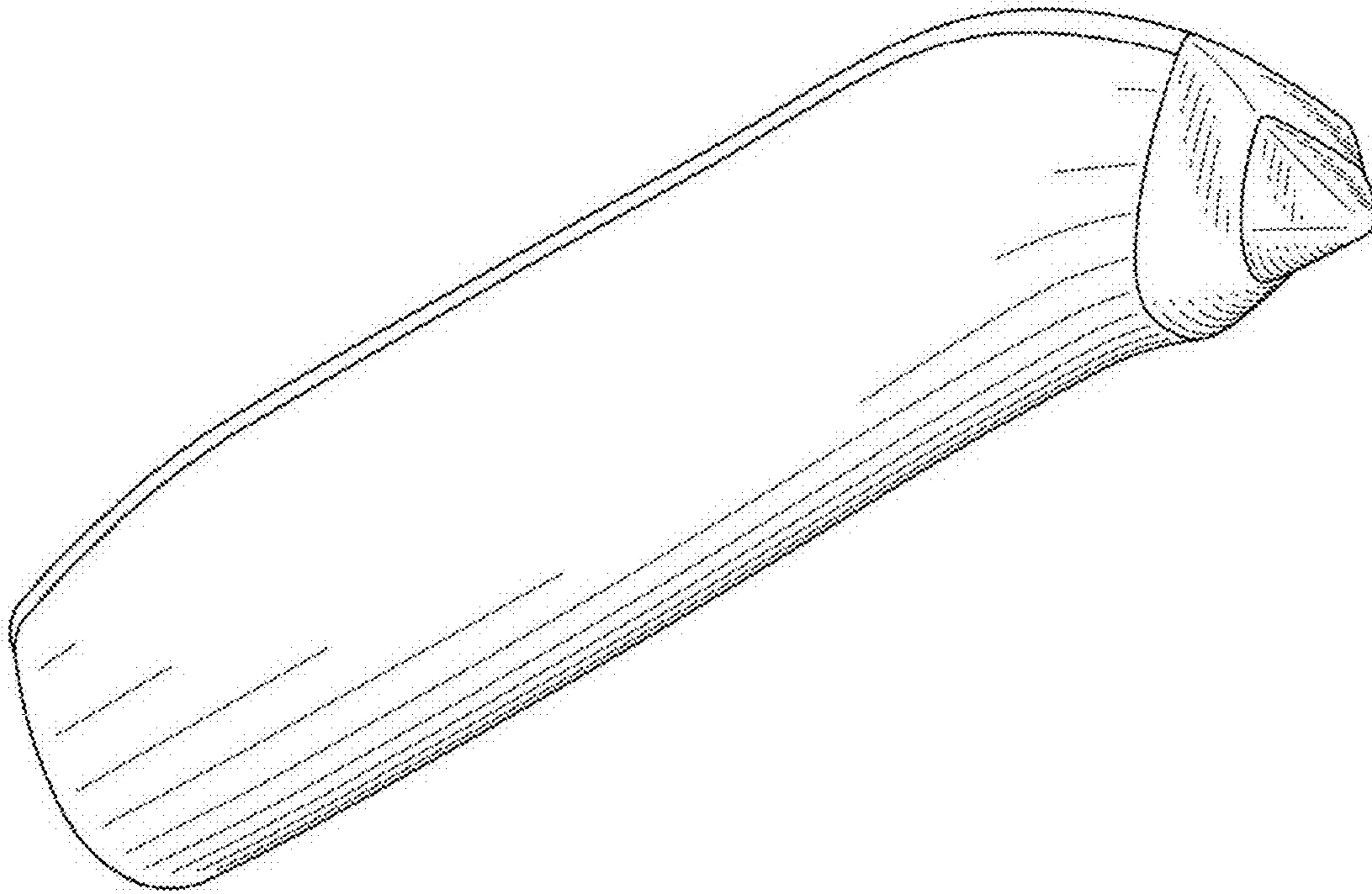

2.1



2.2

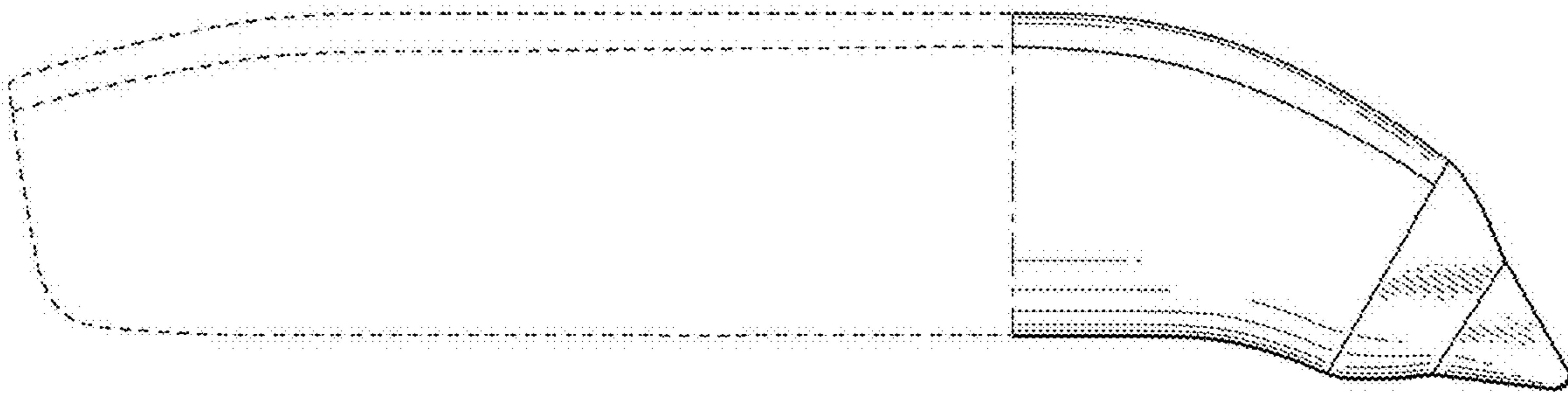

2.3

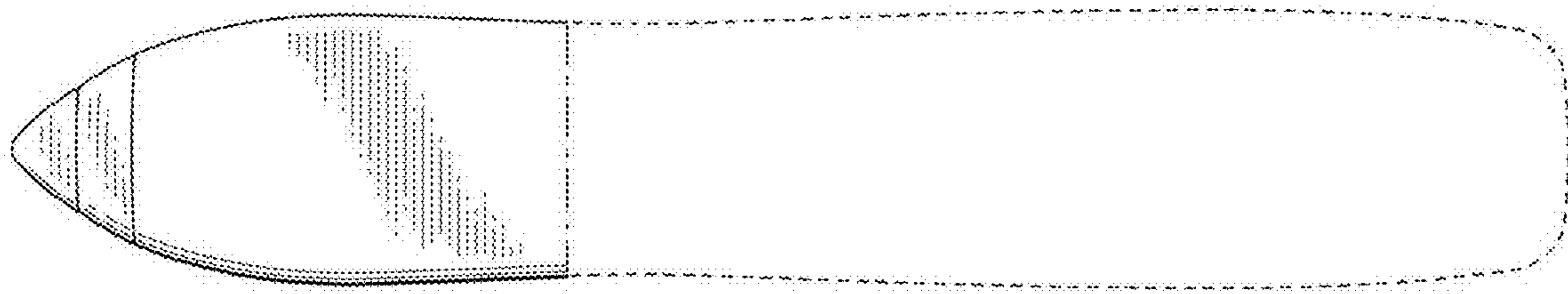

2.4

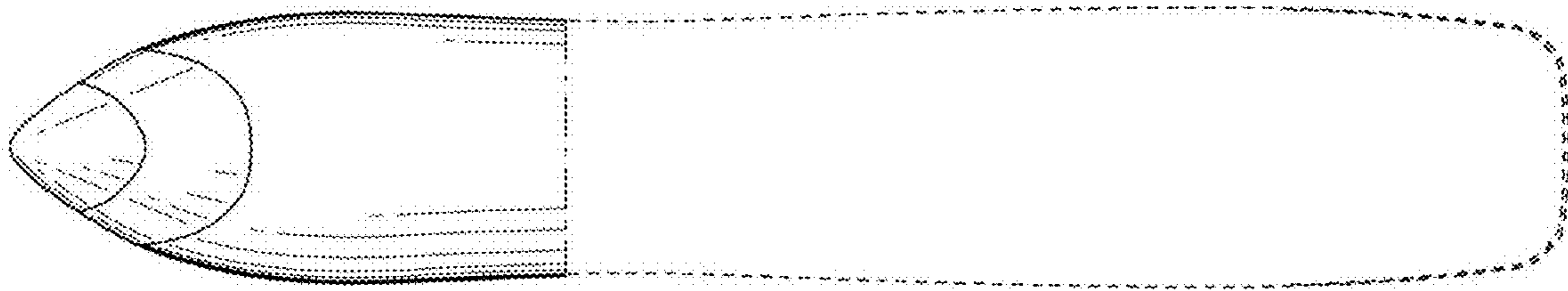

2.5

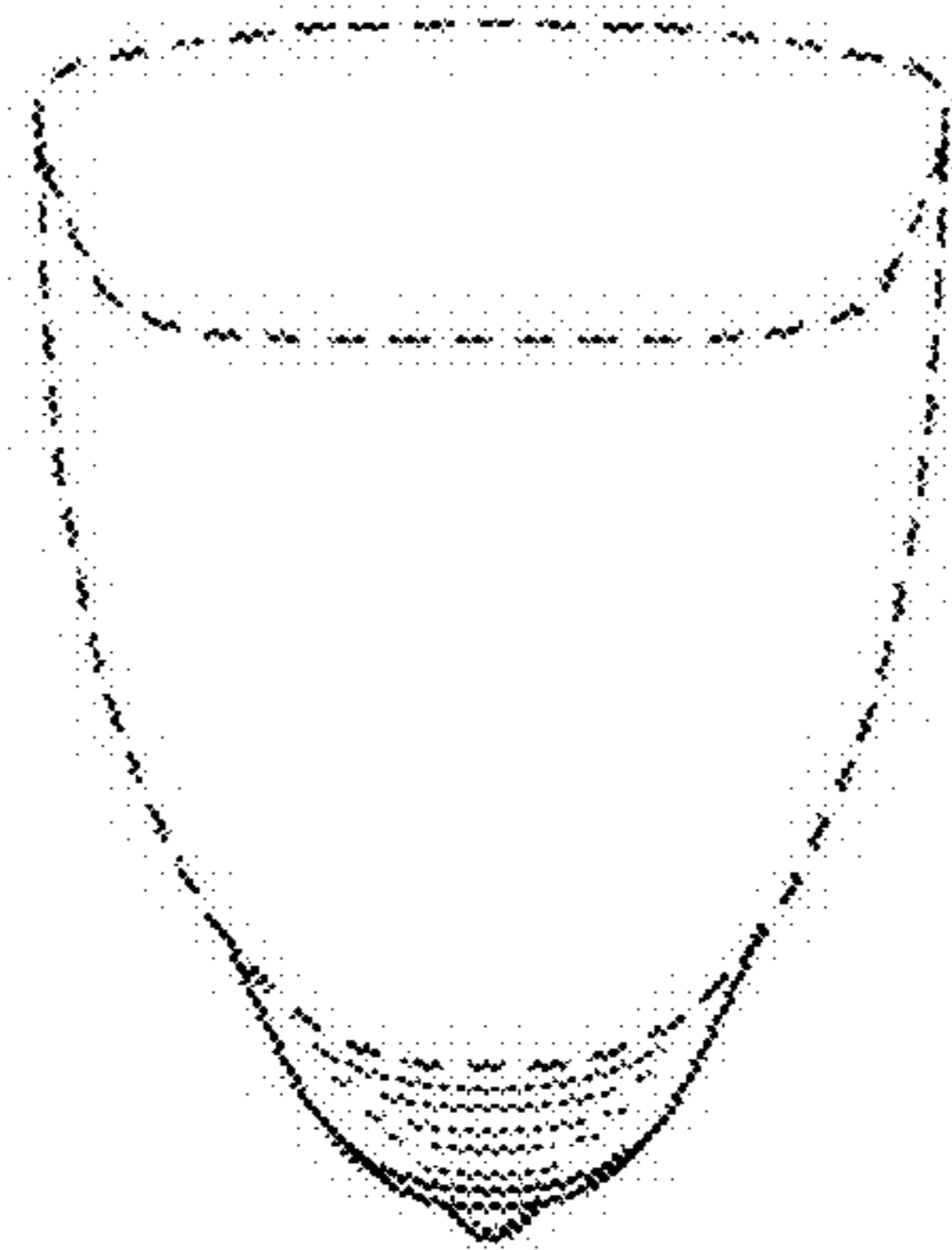

2.6

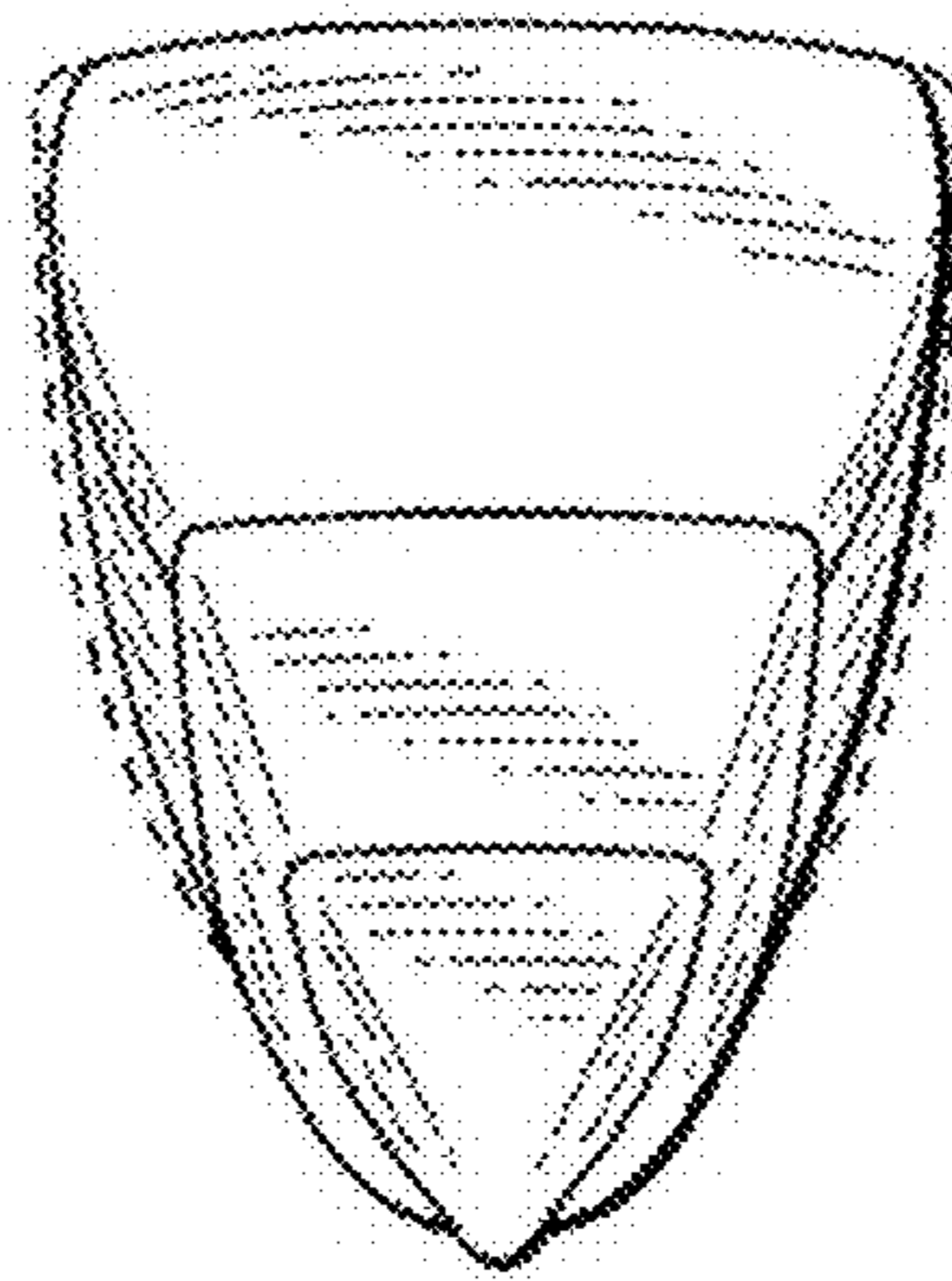

2.7

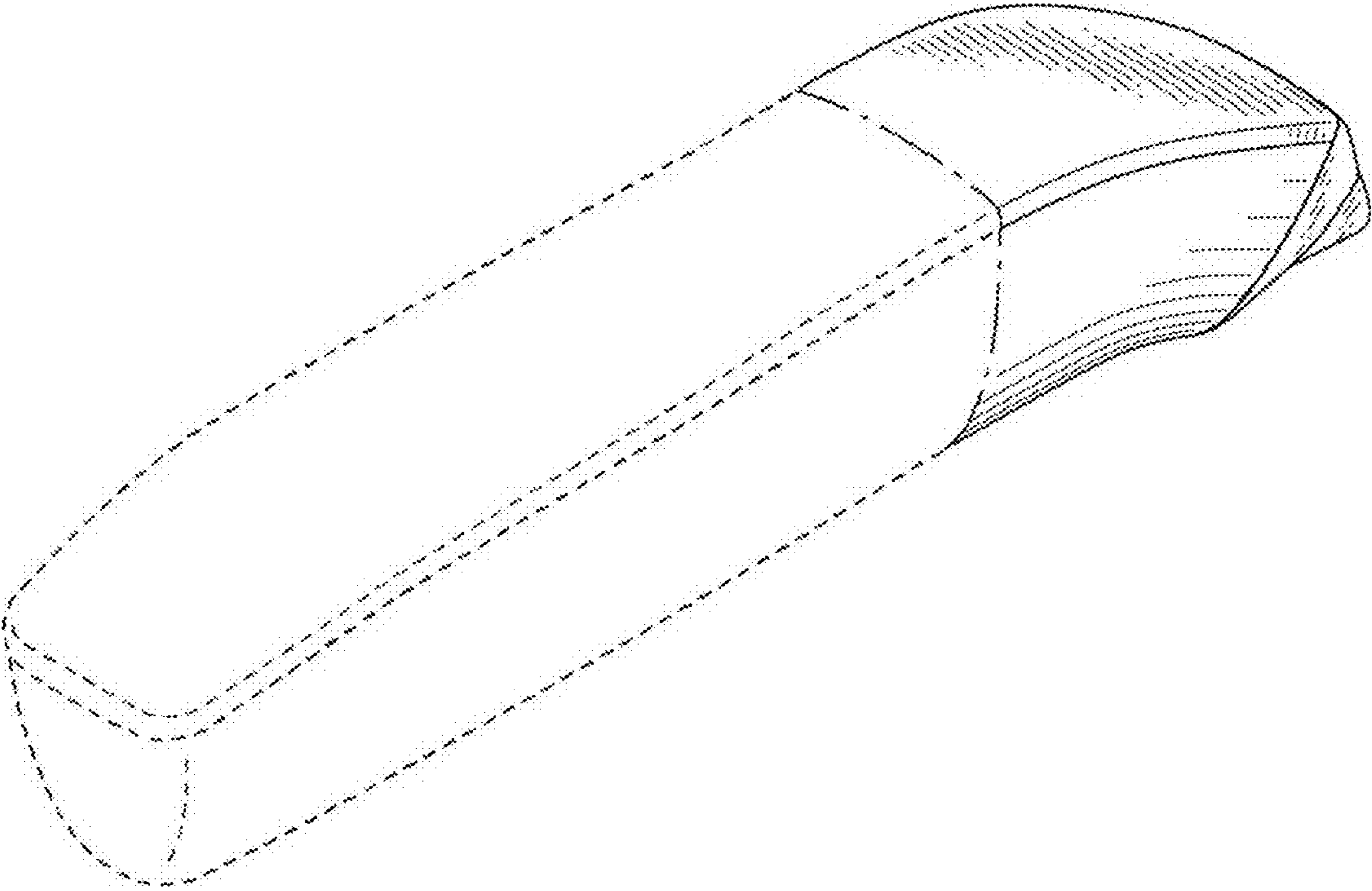

2.8

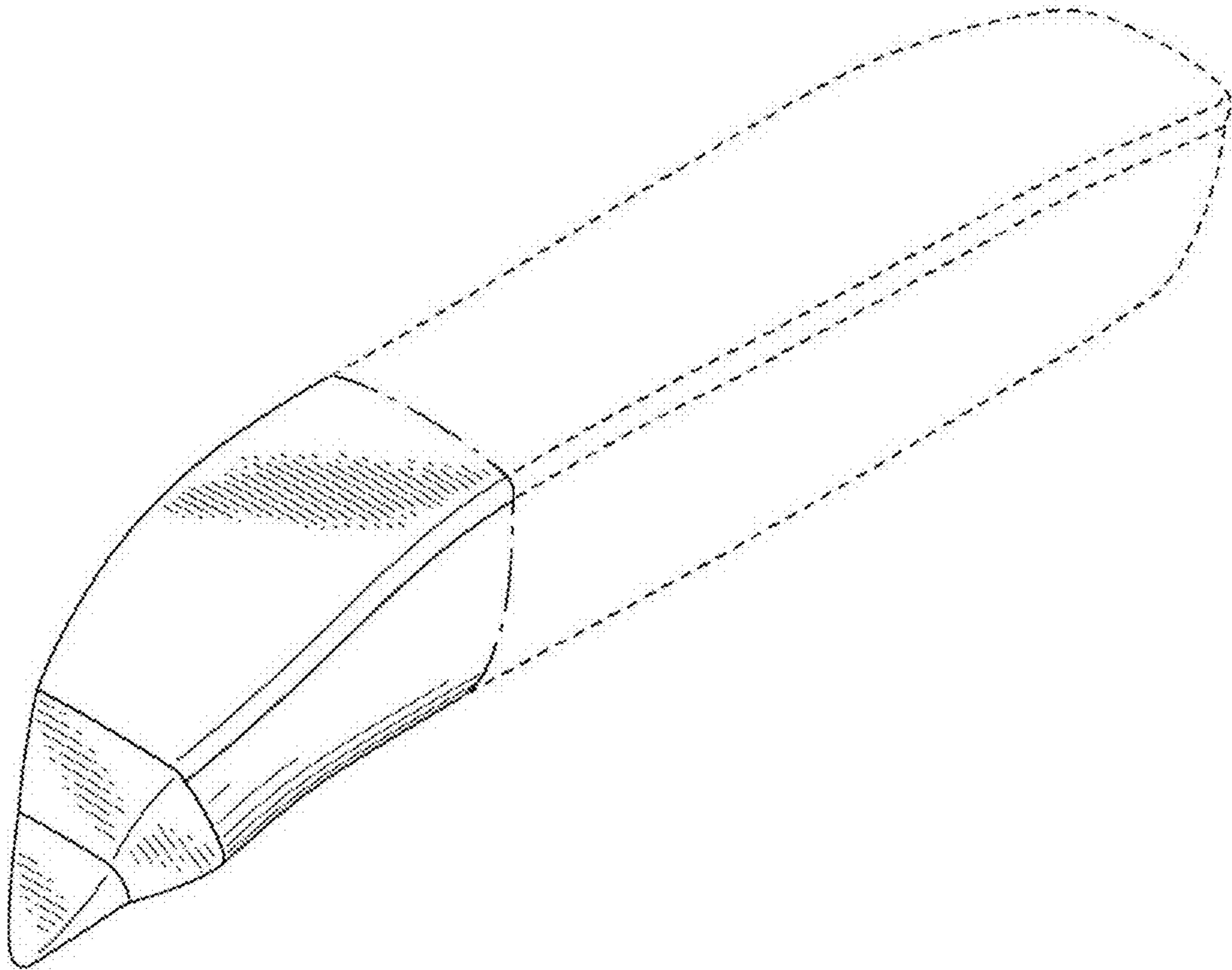

2.9

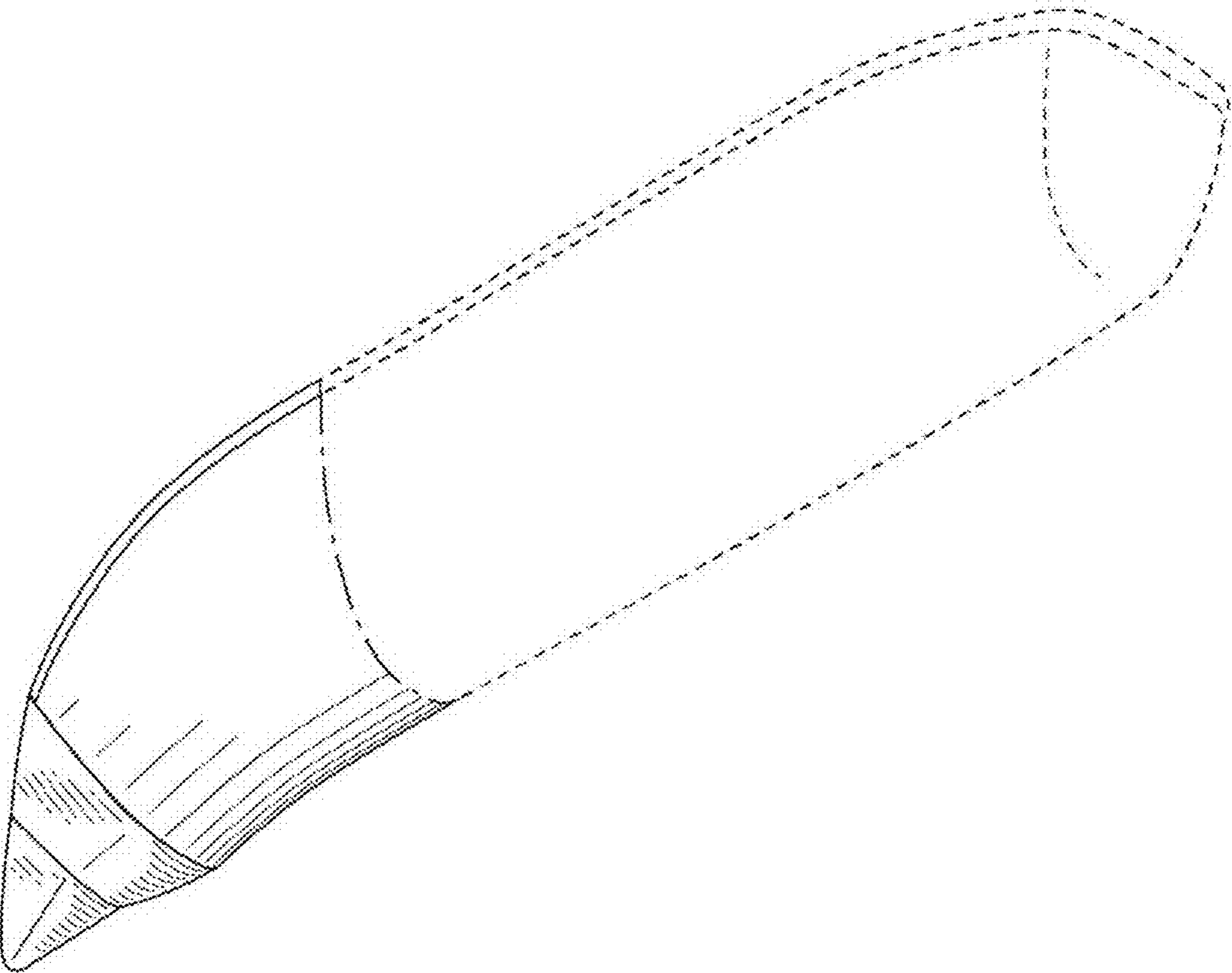

2.10

