



US00D799688S

(12) **United States Design Patent**
Wang

(10) **Patent No.:** **US D799,688 S**

(45) **Date of Patent:** **** Oct. 10, 2017**

(54) **CEILING FAN BLADE**

(71) Applicant: **AIR COOL INDUSTRIAL CO., LTD.**, Taichung (TW)

(72) Inventor: **Cliff Wang**, Taichung (TW)

(73) Assignee: **AIR COOL INDUSTRIAL CO., LTD.**, Taichung (TW)

(**) Term: **15 Years**

(21) Appl. No.: **29/578,835**

(22) Filed: **Sep. 25, 2016**

(51) **LOC (10) Cl.** **23-04**

(52) **U.S. Cl.**
USPC **D23/413**

(58) **Field of Classification Search**
USPC D23/370, 371, 373, 377-379, 380-382,
D23/385-388, 411-414; D26/59;
D12/214

CPC F04D 25/088; F04D 29/005; F04D 29/601;
F04D 29/324; F21V 33/0096; F21V
33/0092; F24F 13/078

See application file for complete search history.

(56) **References Cited**

U.S. PATENT DOCUMENTS

- 2,011,821 A * 8/1935 Meyer B63H 1/26
416/223 R
- 2,022,417 A * 11/1935 Gilbert F04D 29/325
416/221
- D117,860 S * 11/1939 Upson 416/244 R
- 2,222,118 A * 11/1940 Newnham B63H 1/20
416/214 R
- D125,957 S * 3/1941 Moeller D23/413

- D130,032 S * 10/1941 Perston D23/413
- D141,589 S * 6/1945 Logsdon 416/210 R
- D165,246 S * 11/1951 Roffy D23/413
- D180,777 S * 8/1957 Ganger D23/413
- D189,300 S * 11/1960 McLean D23/413
- D206,695 S * 1/1967 Dickinson 416/245 A
- D442,906 S * 5/2001 Prokop D12/214
- D456,502 S * 4/2002 Small D23/413
- D509,295 S * 9/2005 Stauffer D23/413
- D562,215 S * 2/2008 Schulze D12/214
- D675,313 S * 1/2013 Lindgren D23/413
- D677,611 S * 3/2013 Janecke D12/214
- D715,421 S * 10/2014 Schulzman D23/413
- D721,800 S * 1/2015 Busta D23/413
- D741,989 S * 10/2015 Wang D23/413

* cited by examiner

Primary Examiner — Janice Hallmark

(74) *Attorney, Agent, or Firm* — Pai Patent & Trademark Law Firm; Chao-Chang David Pai

(57) **CLAIM**

The ornamental design for a ceiling fan blade, as shown and described.

DESCRIPTION

FIG. 1 is a front top perspective view of a ceiling fan blade showing my new design;

FIG. 2 is a front elevational view thereof;

FIG. 3 is a rear elevational view thereof;

FIG. 4 is a left side elevational view thereof;

FIG. 5 is a right side elevational view thereof;

FIG. 6 is a top plan view thereof;

FIG. 7 is a bottom plan view thereof; and,

FIG. 8 is a front bottom perspective view thereof.

The broken lines are for the purpose of illustrating environmental structure and form no part of the claimed design.

1 Claim, 6 Drawing Sheets

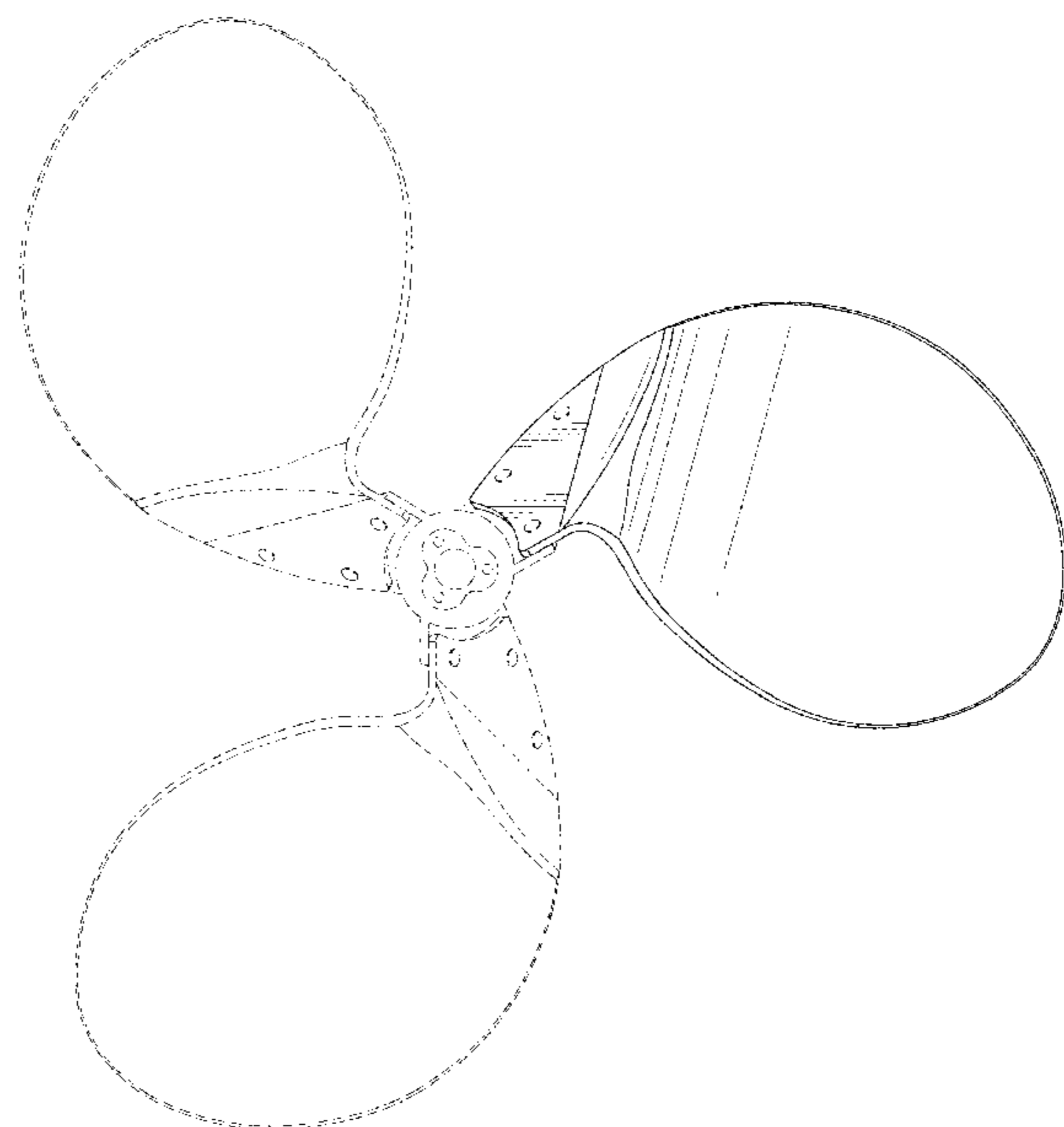
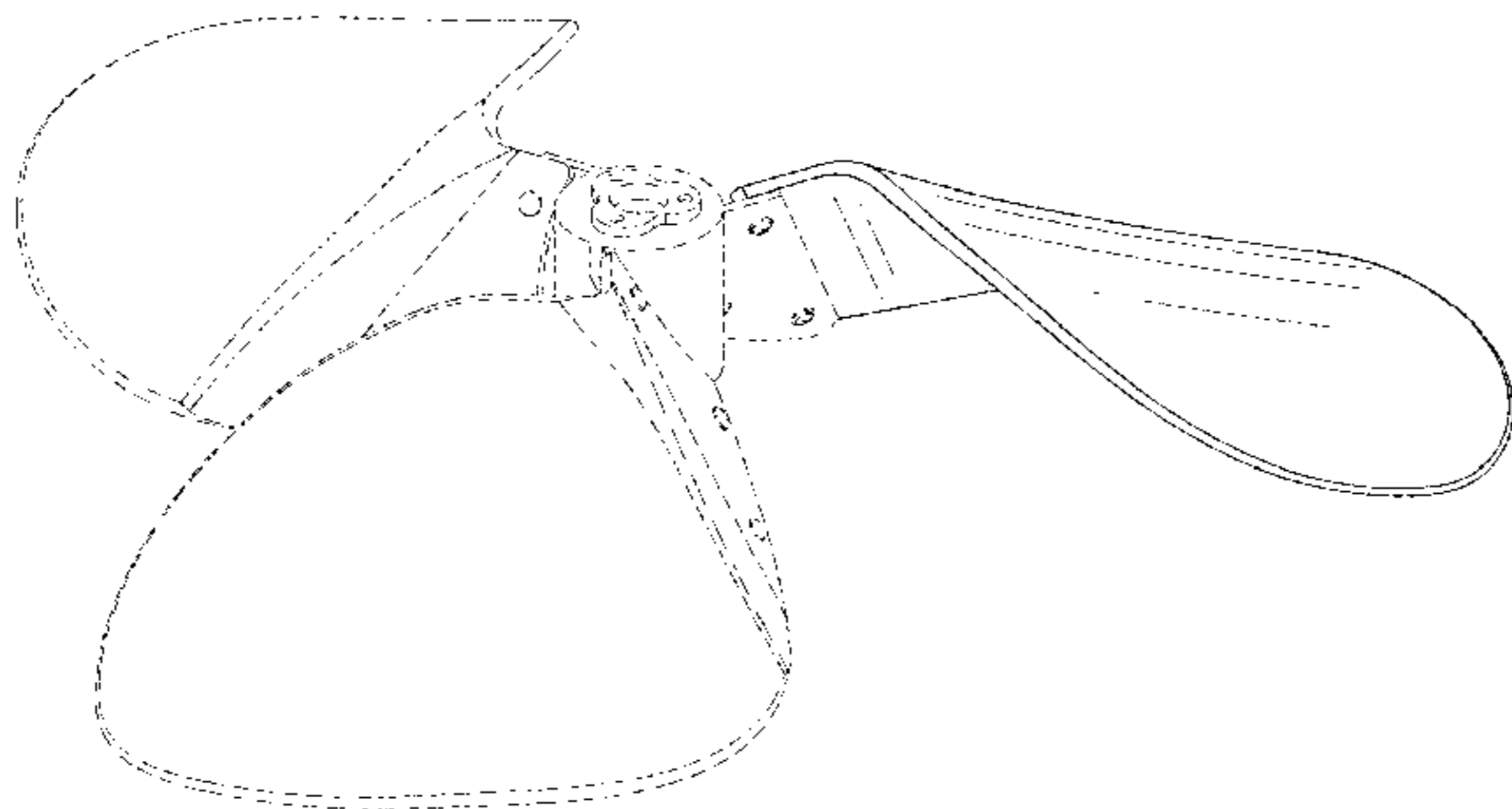

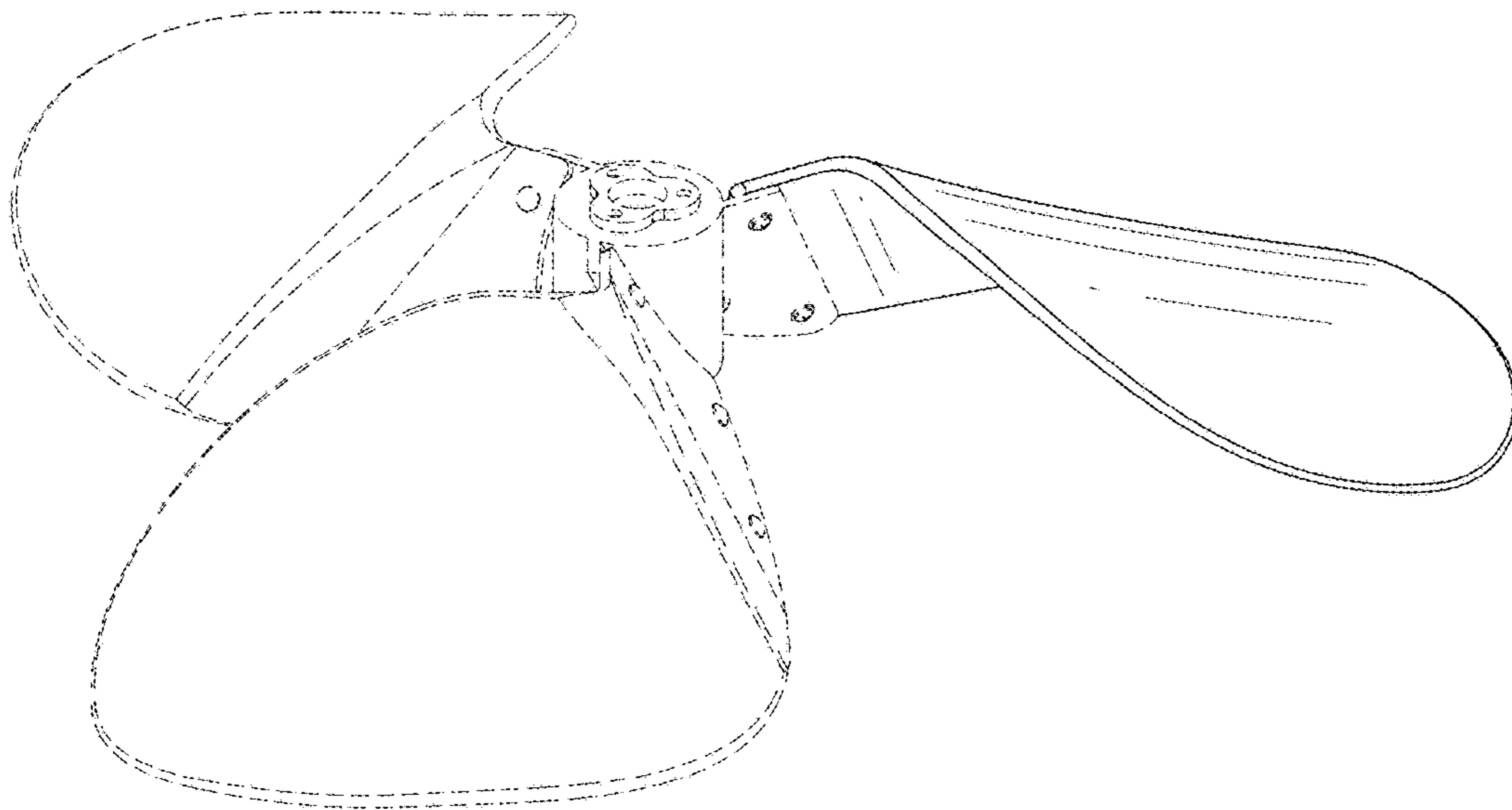

FIG. 1

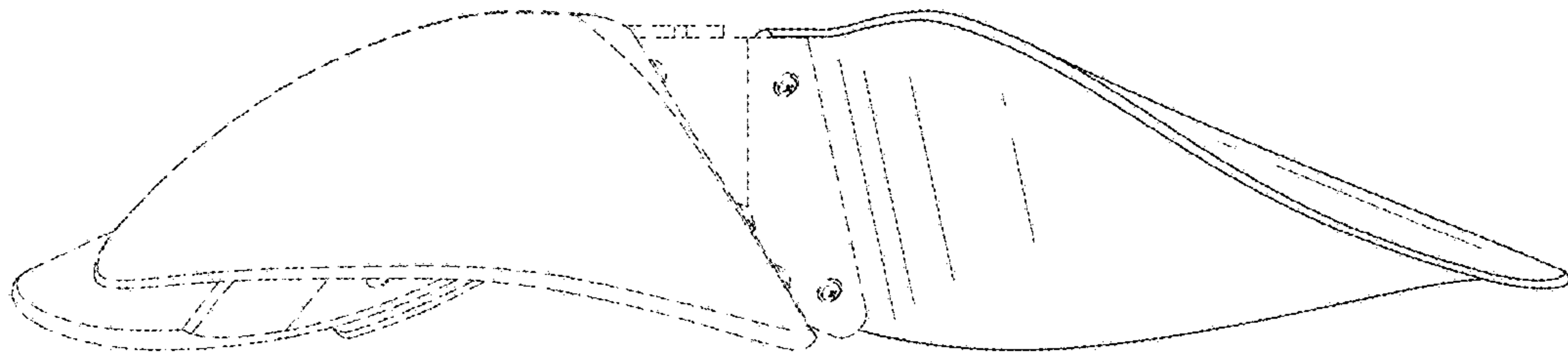

FIG. 2

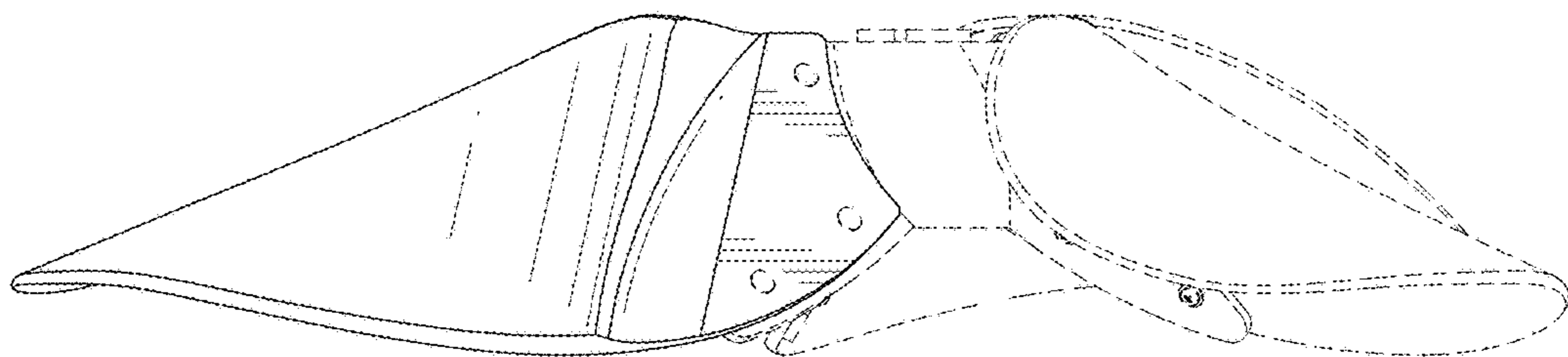

FIG. 3

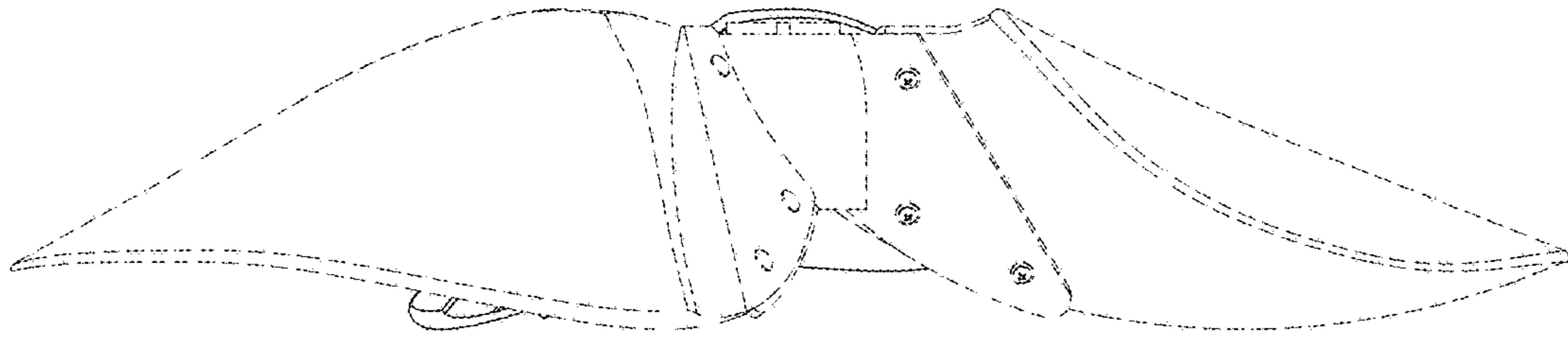

FIG. 4

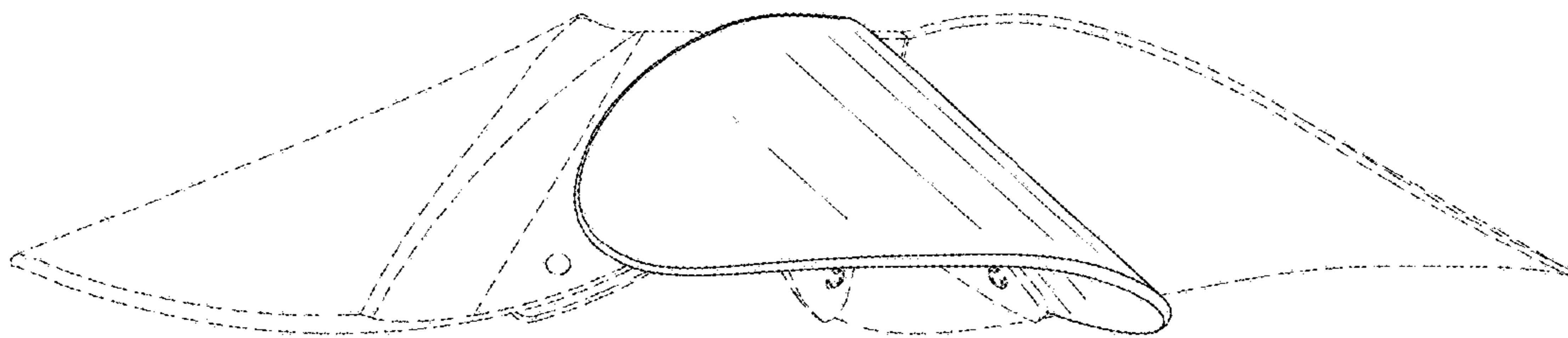

FIG. 5

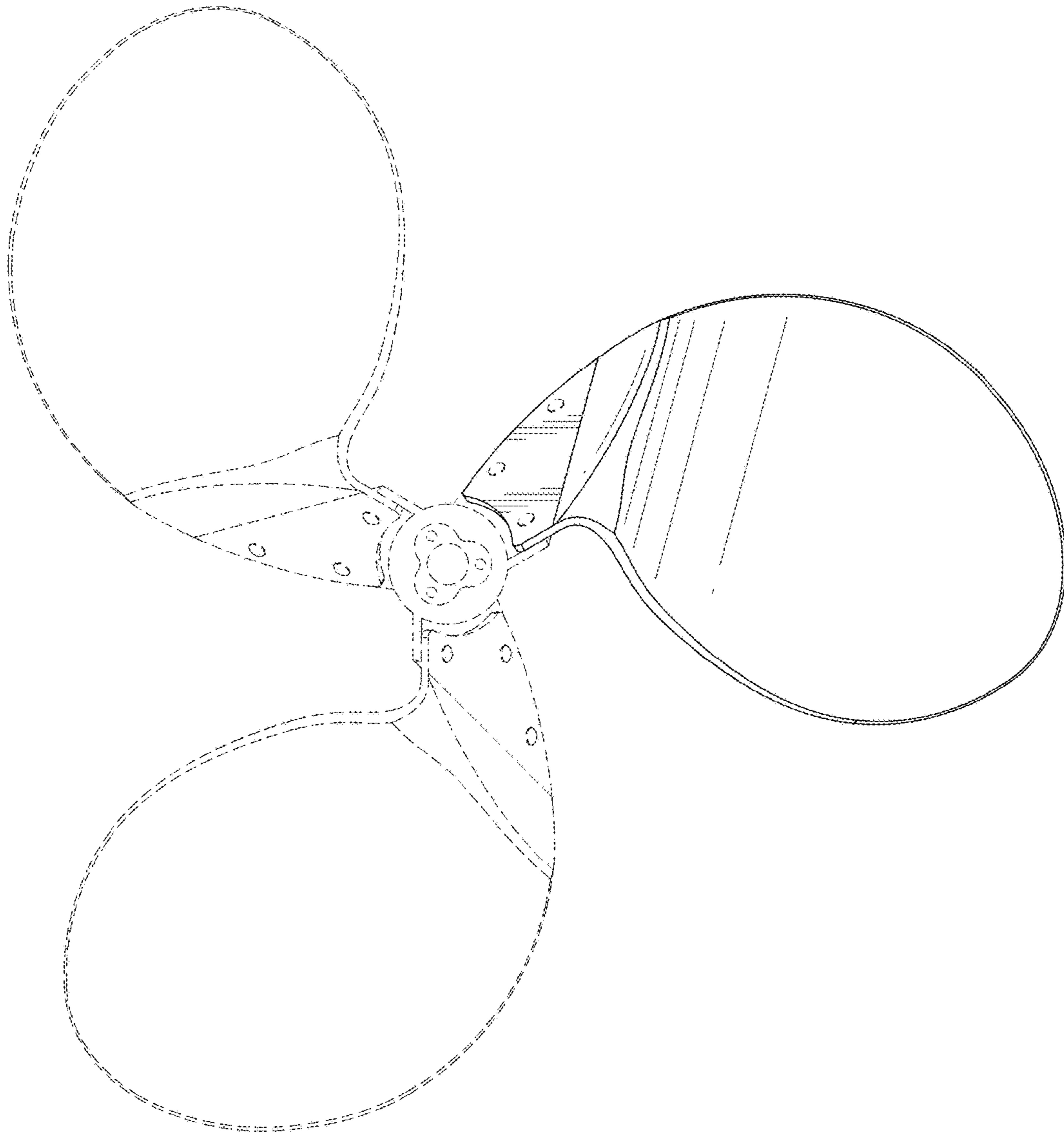

FIG. 6

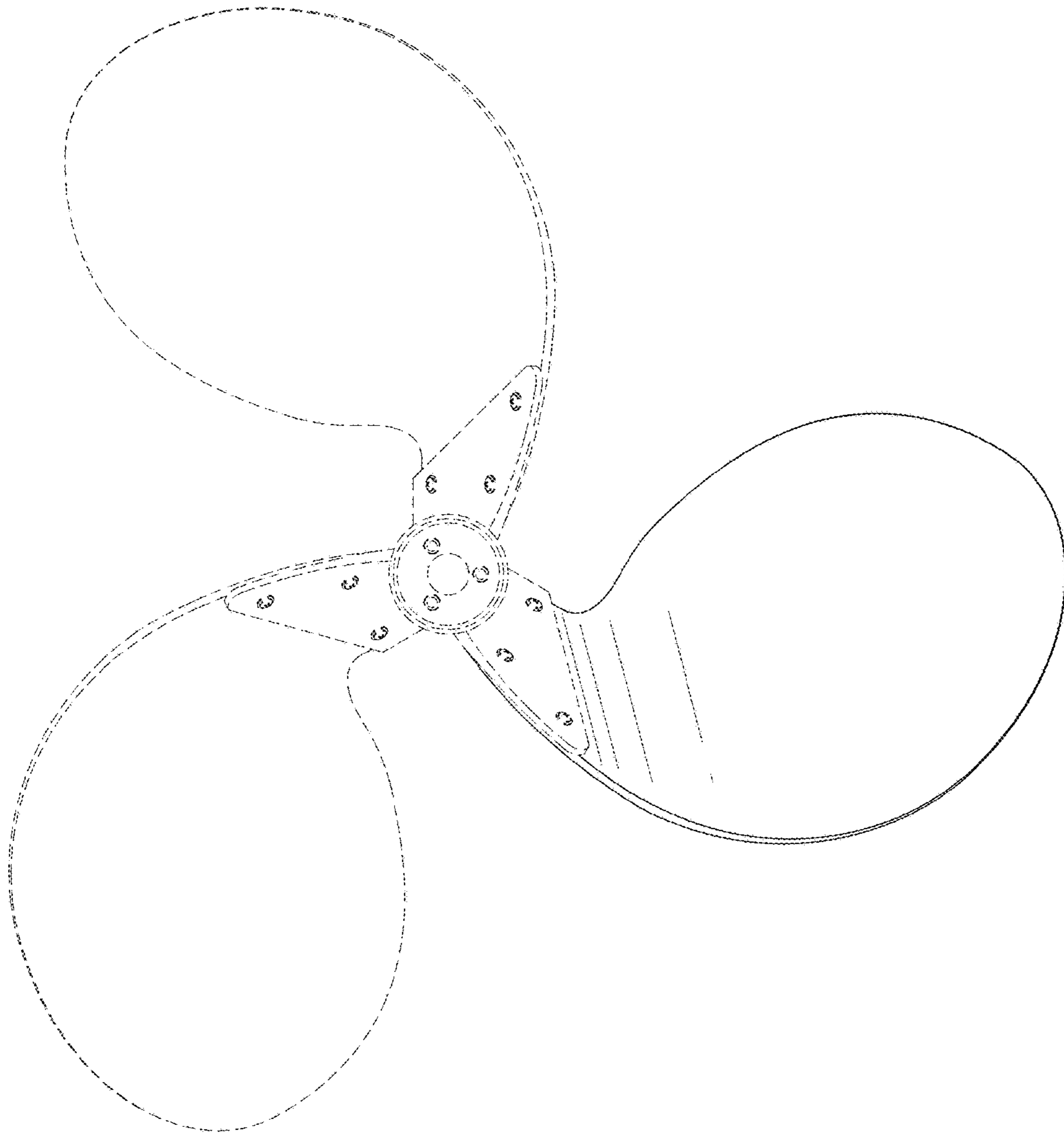

FIG. 7

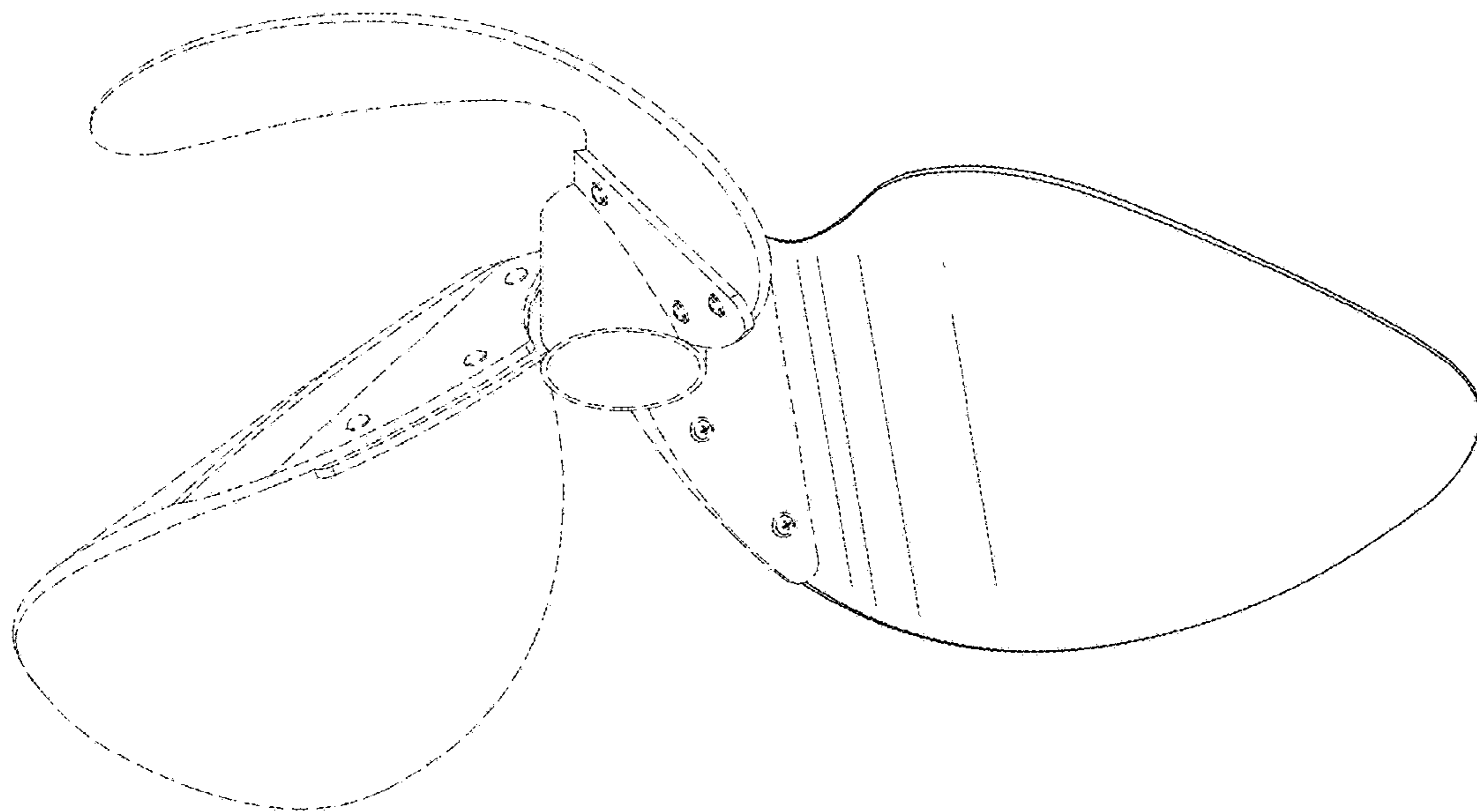

FIG. 8