



US00D799648S

(12) **United States Design Patent**
Chong

(10) **Patent No.:** **US D799,648 S**

(45) **Date of Patent:** **** Oct. 10, 2017**

(54) **SINK**

(71) Applicant: **Elkay Manufacturing Company**, Oak Brook, IL (US)

(72) Inventor: **Jonathan Chee Yeen Chong**, Chicago, IL (US)

(73) Assignee: **Elkay Manufacturing Company**, Oak Brook, IL (US)

(**) Term: **15 Years**

(21) Appl. No.: **29/554,211**

(22) Filed: **Feb. 9, 2016**

(51) **LOC (10) Cl.** **23-01**

(52) **U.S. Cl.**

USPC **D23/284**

(58) **Field of Classification Search**

USPC D23/284, 293.1, 287-292, 303, 308

(Continued)

(56) **References Cited**

U.S. PATENT DOCUMENTS

D363,627 S 10/1995 North

D481,894 S 11/2003 Hunt

(Continued)

OTHER PUBLICATIONS

“004091 Classic+ Worktop Stainless Steel Kitchen Sink”, Home Refinements—Julien, Inc., <http://www.homerefinelements.ca/en/product/model/004091>. (Downloaded from internet Sep. 21, 2016).

(Continued)

Primary Examiner — Robert M Spear

Assistant Examiner — John Voytek

(74) *Attorney, Agent, or Firm* — Leydig, Voit & Mayer, Ltd.

(57) **CLAIM**

The ornamental design for a sink, as shown and described.

DESCRIPTION

FIG. 1 is an isometric view taken from the top, front, and right side of a first embodiment of a sink showing our new design;

FIG. 2 is an isometric view taken from the top, front, and left side of a first embodiment of a sink showing our new design;

FIG. 3 is a top plan view of the sink shown in FIG. 1;

FIG. 4 is a bottom view of the sink shown in FIG. 1;

FIG. 5 is a cross-section view of the sink taken in the direction of line 5-5 in FIG. 3;

FIG. 6 is a cross-section view of the sink taken in the direction of line 6-6 in FIG. 3;

FIG. 7 is a cross-section view of the sink taken in the direction of line 7-7 in FIG. 3;

FIG. 8 is a cross-section view of the sink taken in the direction of line 8-8 in FIG. 3;

FIG. 9 is an isometric view taken from the top, front, and left side of a second embodiment of a sink showing our new design;

FIG. 10 is an isometric view taken from the top, front, and right side of a second embodiment of a sink showing our new design;

FIG. 11 is a top plan view of the sink shown in FIG. 9;

FIG. 12 is a bottom view of the sink shown in FIG. 9;

FIG. 13 is a cross-section view of the sink taken in the direction of line 13-13 in FIG. 11;

FIG. 14 is a cross-section view of the sink taken in the direction of line 14-14 in FIG. 11;

FIG. 15 is a cross-section view of the sink taken in the direction of line 15-15 in FIG. 11; and,

FIG. 16 is a cross-section view of the sink taken in the direction of line 16-16 in FIG. 11.

In the drawings, the broken lines depict environmental subject matter only and form no part of the claimed design.

1 Claim, 16 Drawing Sheets

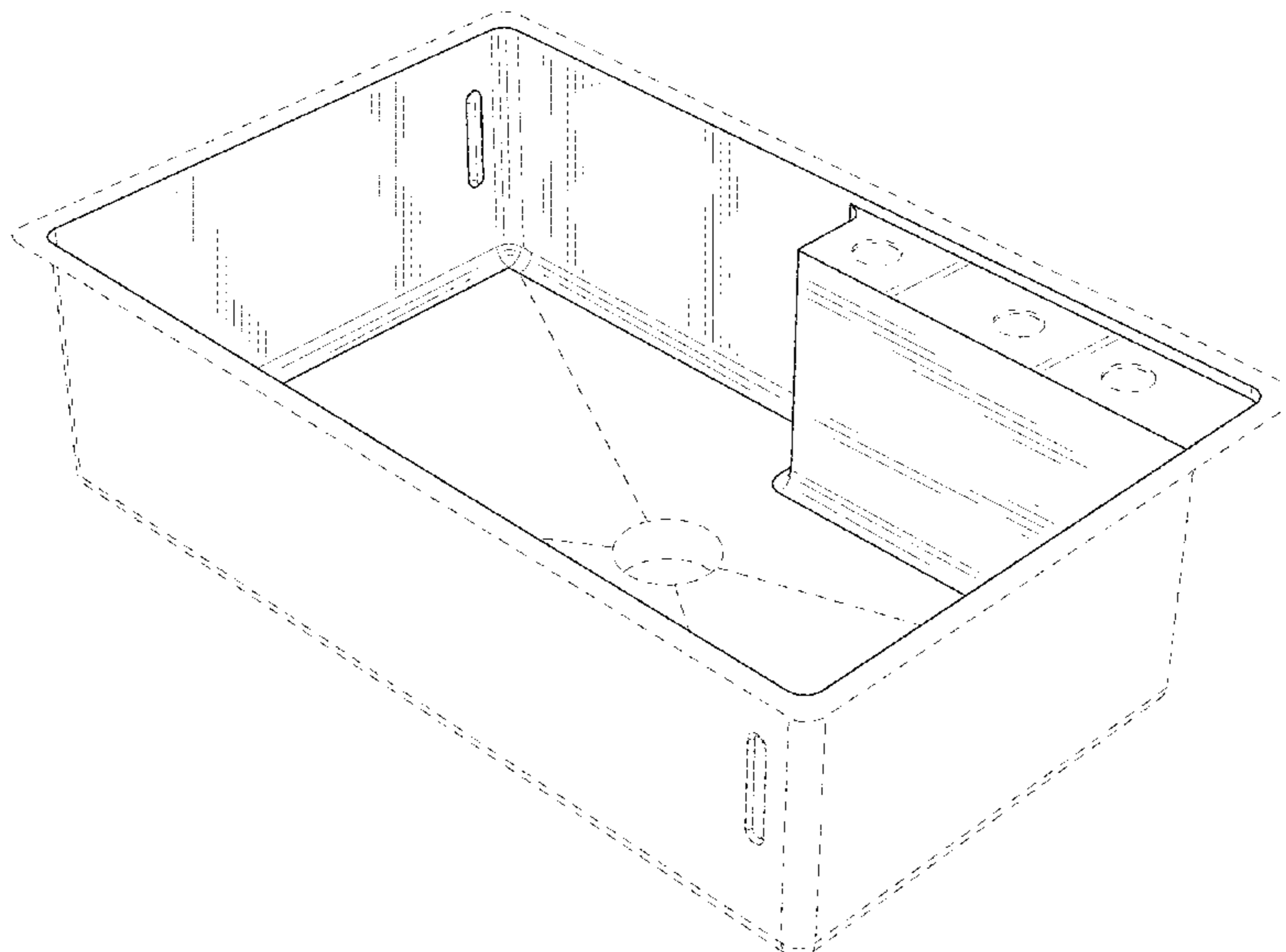

- (58) **Field of Classification Search**
 CPC A47K 1/04; A47B 77/06; A47J 47/20
 See application file for complete search history.

(56) **References Cited**

U.S. PATENT DOCUMENTS

D486,644 S	2/2004	Claypool	
D504,169 S *	4/2005	Gross	D23/284
D546,593 S	7/2007	Bergin	
D549,806 S *	8/2007	Taylor	D23/284
D552,721 S *	10/2007	Kurth	D23/284
D577,913 S	10/2008	Thompson et al.	
D595,775 S	7/2009	Weinstein	
D603,025 S *	10/2009	Mahon	D23/284
D679,528 S	4/2013	Gilboe et al.	
D682,401 S *	5/2013	Mustee	D23/284
D694,377 S *	11/2013	Mustee	D23/284
D697,309 S	1/2014	Baldwin et al.	
D711,665 S	8/2014	Mattei	
D717,411 S *	11/2014	Kuch	D23/284
D723,302 S	3/2015	Goodman et al.	
D725,911 S	4/2015	McManus et al.	
D726,446 S	4/2015	Tollasepp et al.	
9,022,266 B1	5/2015	Kleppin	
D731,728 S	6/2015	Evans et al.	
D764,315 S	8/2016	Rachocki et al.	
D770,020 S *	10/2016	Lilly	D23/284

OTHER PUBLICATIONS

- “À la Carte Options,” Home Refinements—Julien, Inc., http://www.homerefinements.ca/en/a_la_carte/options/. (Downloaded from internet Sep. 21, 2016).
- “Innovative Kitchen Sinks—Interior Design Inspiration,” Eva Designs, <http://www.evadesigns.com/interior-design/kitchen/innovative-kitchen-sinks>. (Jul. 20, 2010).
- “OL-320L,” Oulin, <http://www.oulin.com.ok/my-product/sink-21/>. (Jul. 9, 2014).
- “One™ Stainless Steel Sink Accessories,” Blanco, http://www.blanco-germany.com/en_us/en_us/sinks/sink_accessories/one_acc/sets.html. (Downloaded from internet Sep. 21, 2016).
- “Strive Under-Mount Kitchen Sink, K-5281-NA,” Kohler, <http://www.us-kohler.com/us/Strive%E2%84%A2-32-x-18-1-4-x-9-5-16-under-mount-double-equal-kitchen-sink-with-basin-rack/productDetail/Under-Mount-Sinks/941424.htm?brandId=969700&skufd=941401&categoryId=651473&hash=id%3Dfilters%26startIndex%3D20%26scrollTop%3D300>. (Downloaded from internet Sep. 21, 2016).
- “The BLANCO QUATRUS™ Collection,” Blanco, http://www.blanco-germany.com/en_us/en_us/sinks/new_sinks/new_accessories/quatrus_accessories.html. (Downloaded from internet Sep. 21, 2016).

* cited by examiner

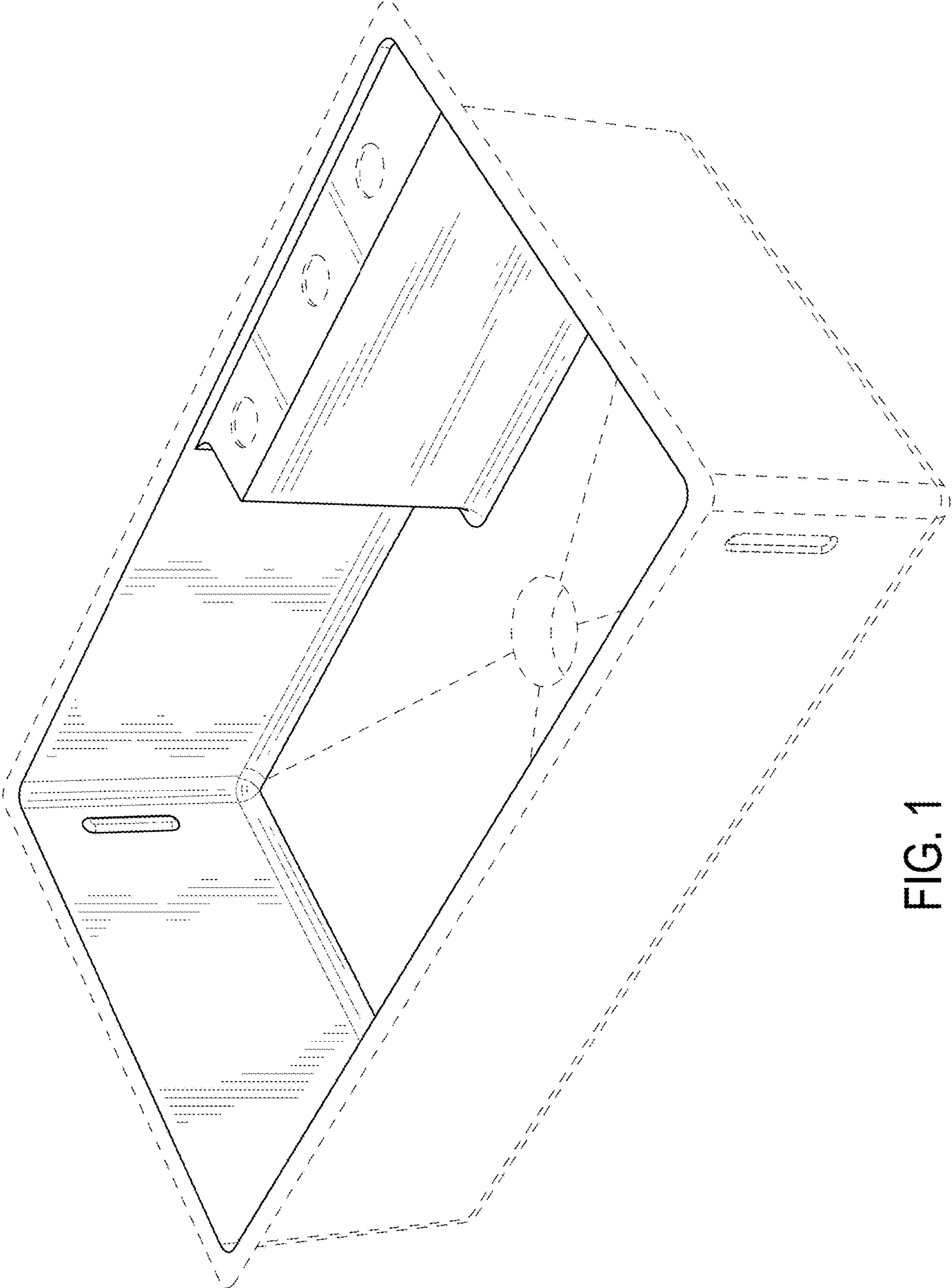

FIG. 1

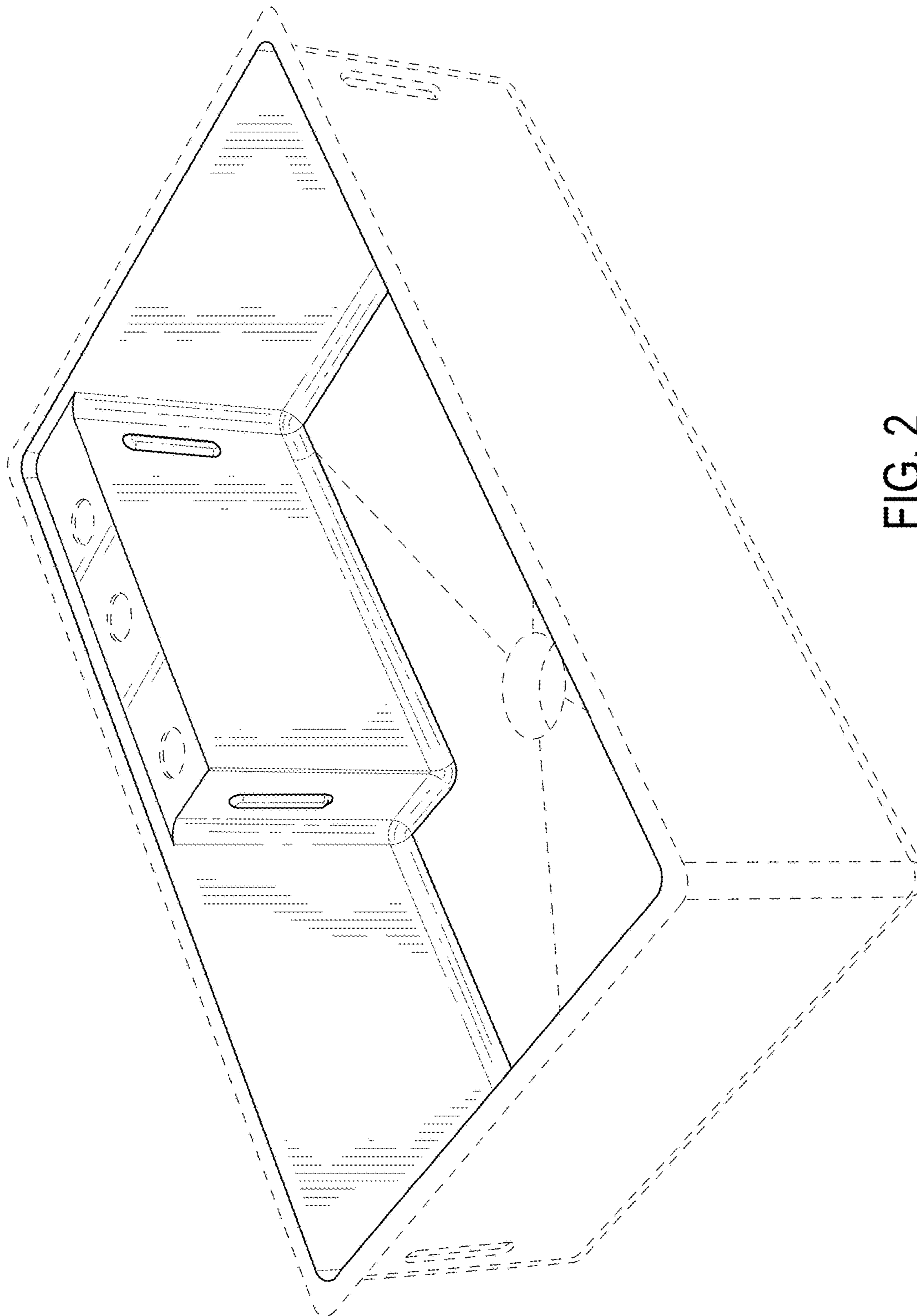

FIG. 2

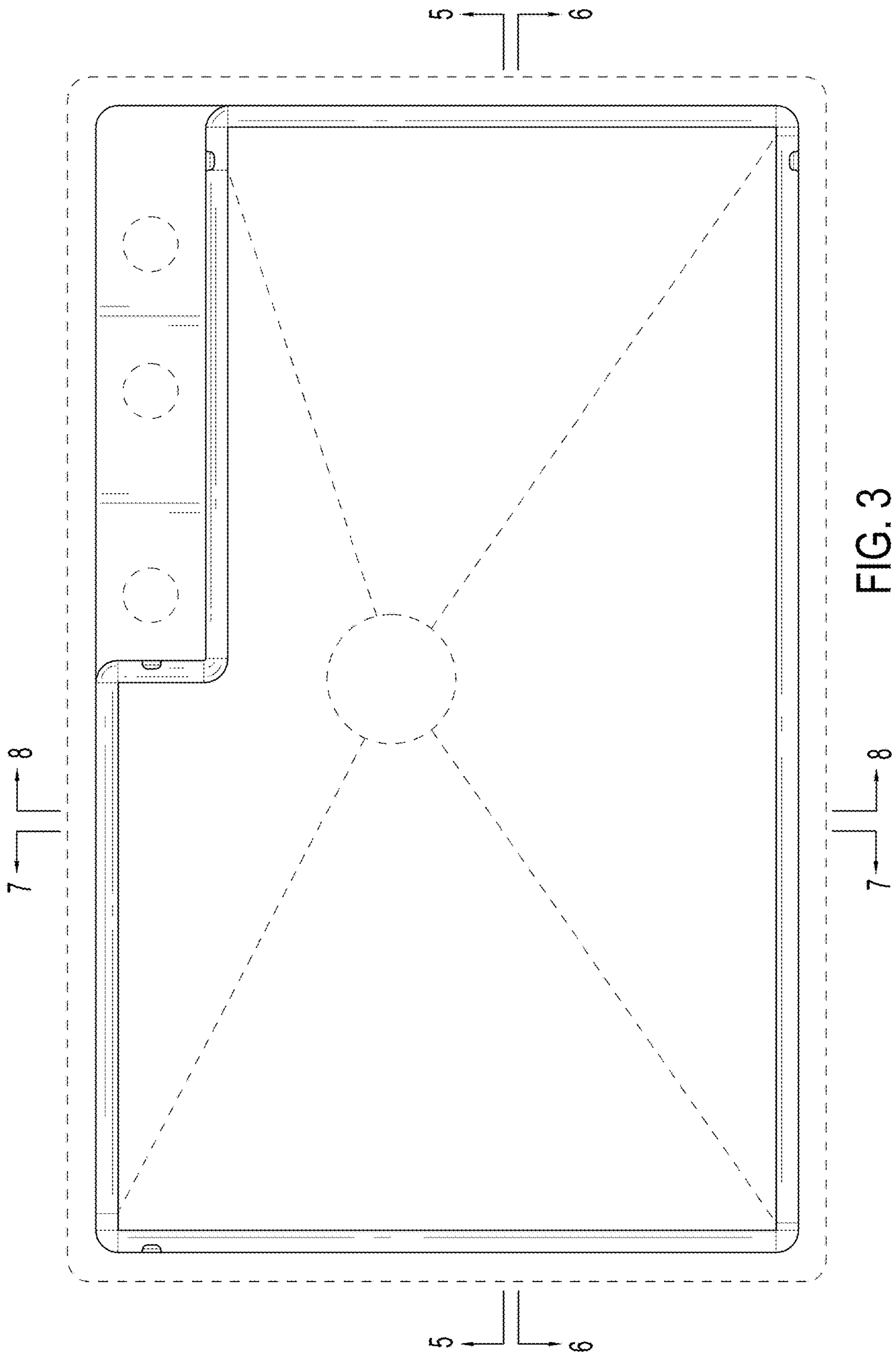

FIG. 3

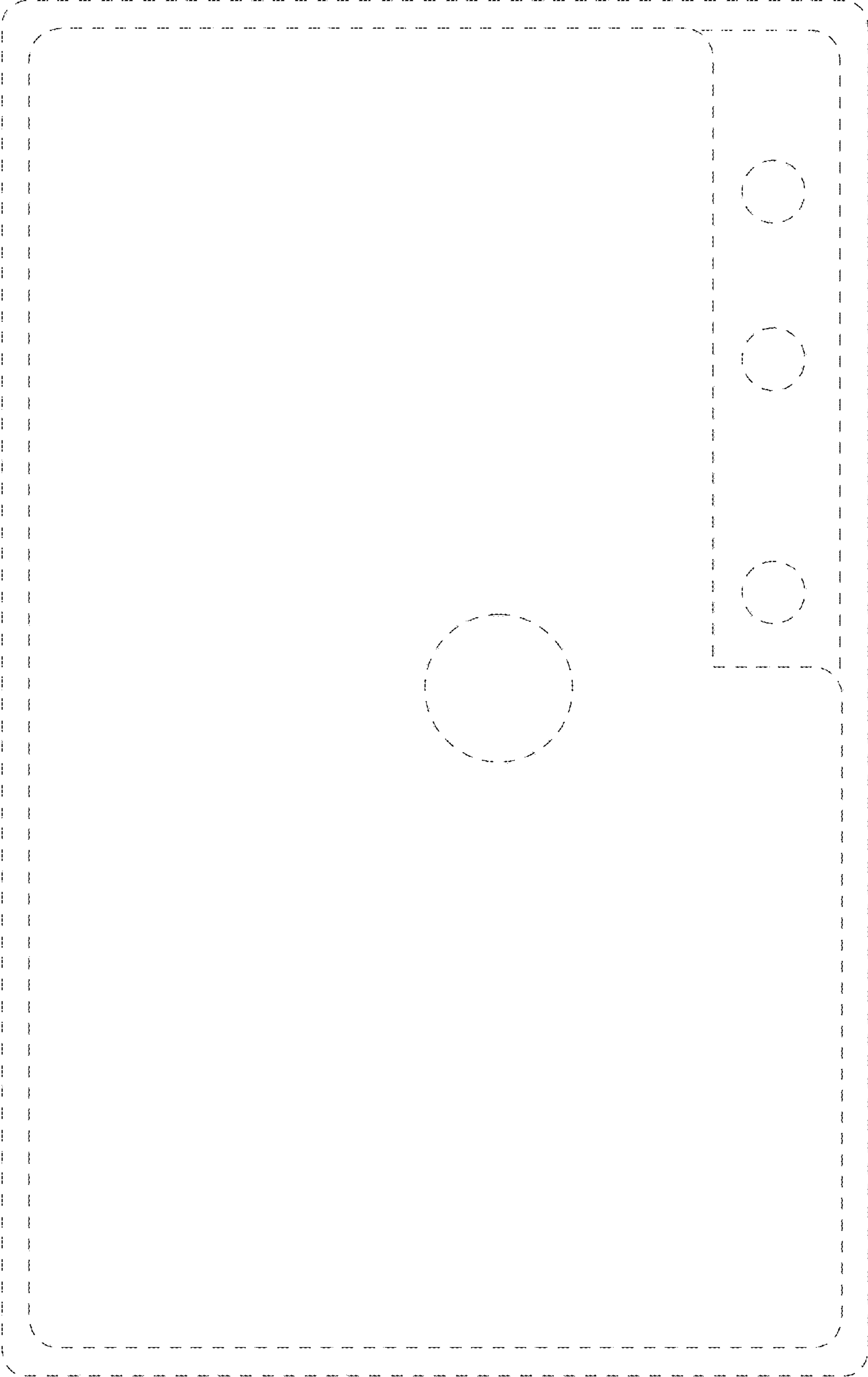

FIG. 4

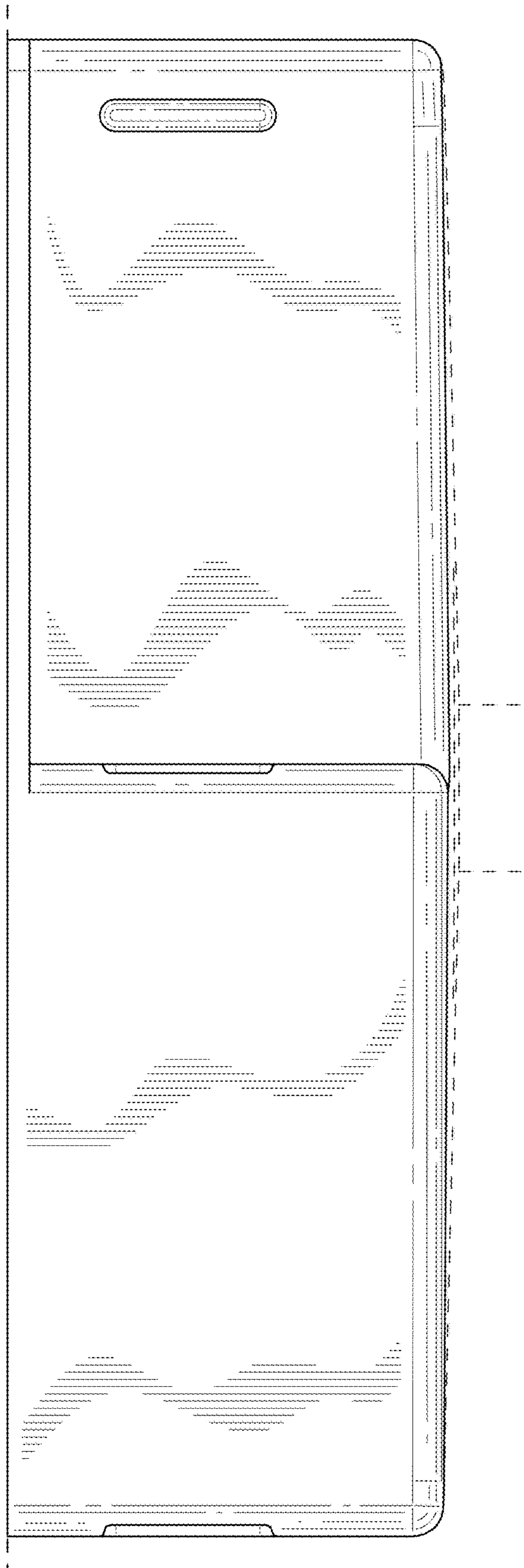

FIG. 5

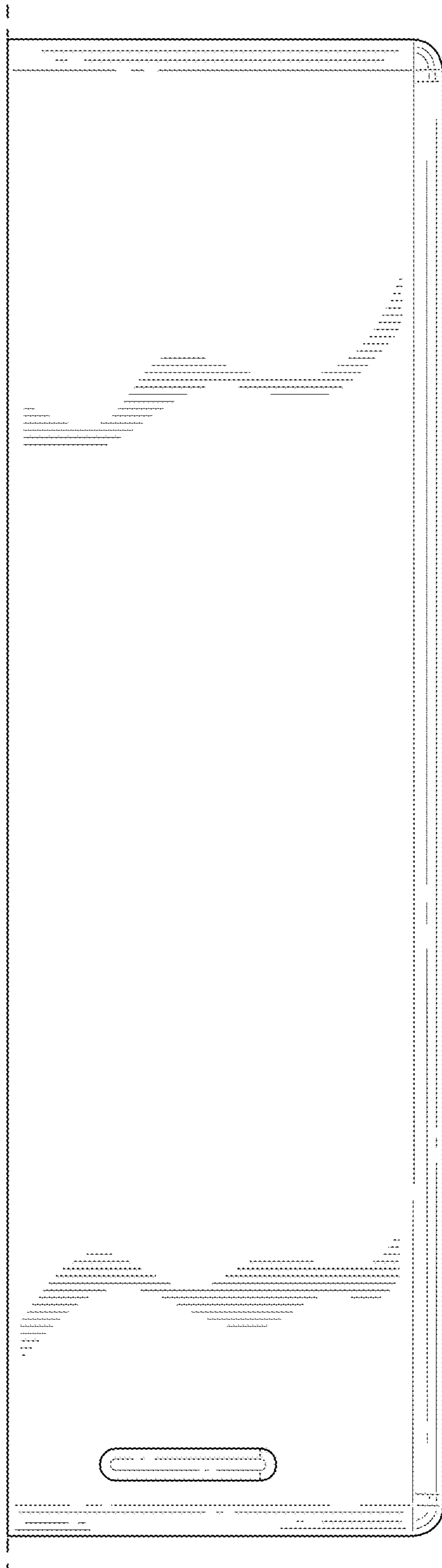

FIG. 6

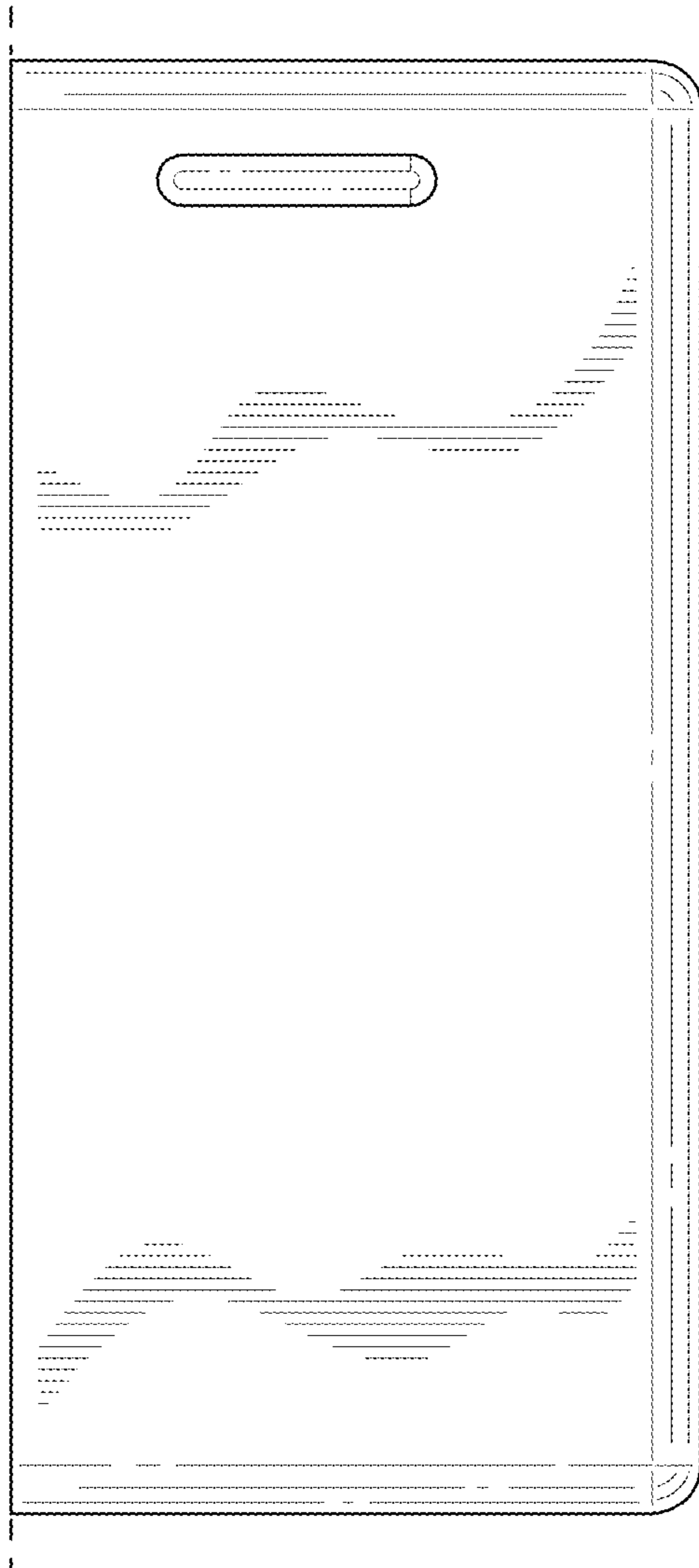

FIG. 7

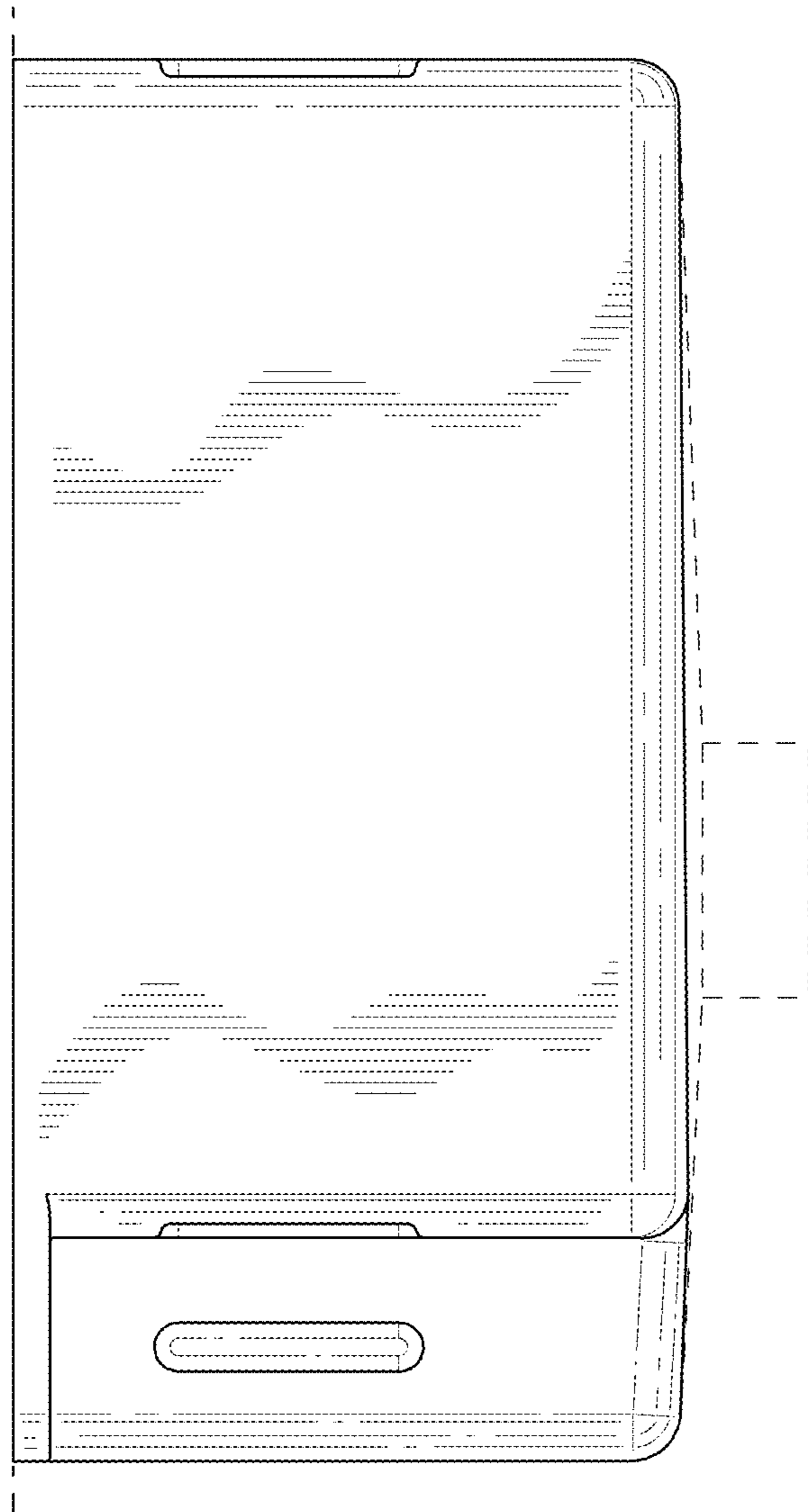

FIG. 8

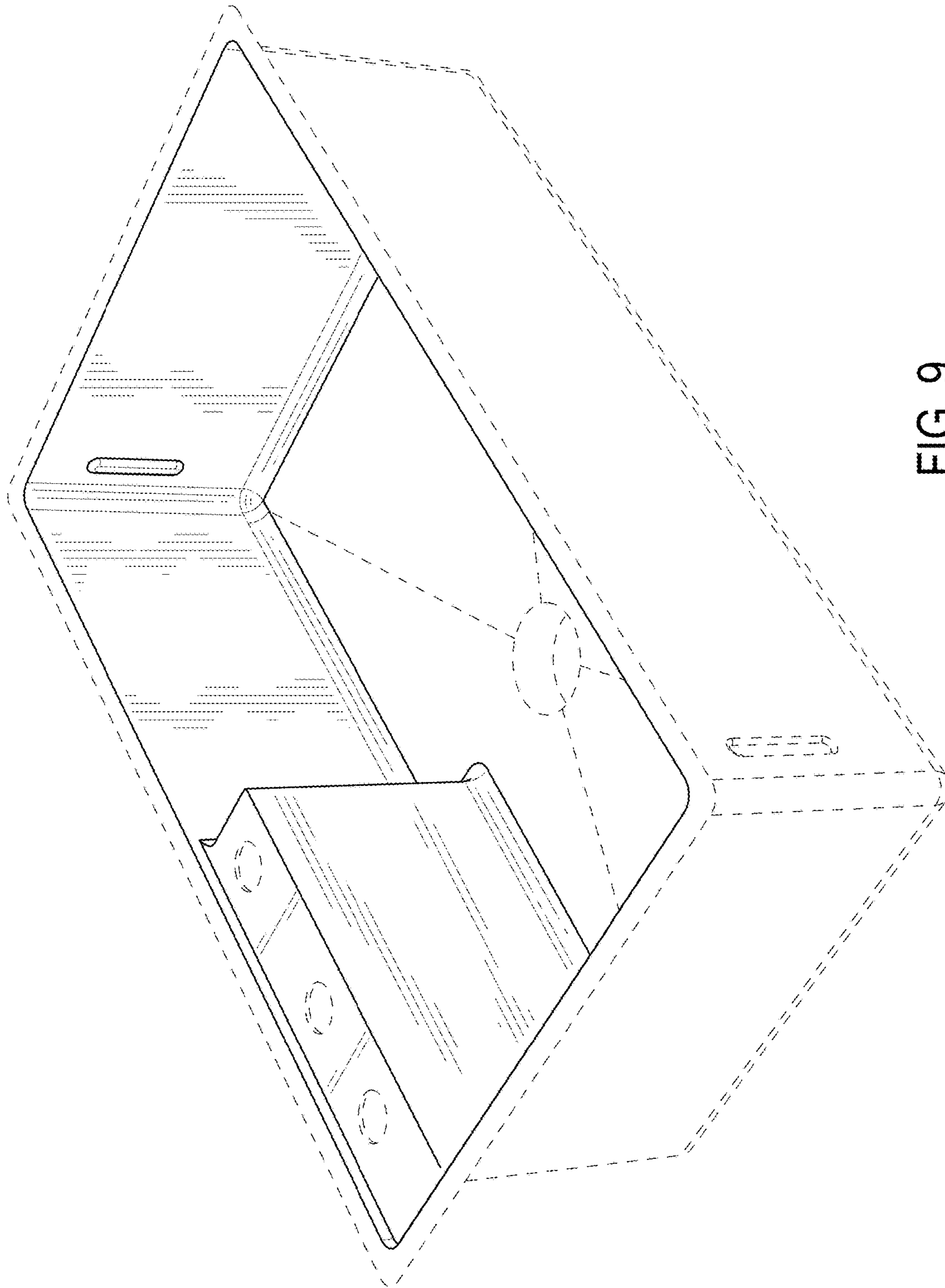

FIG. 9

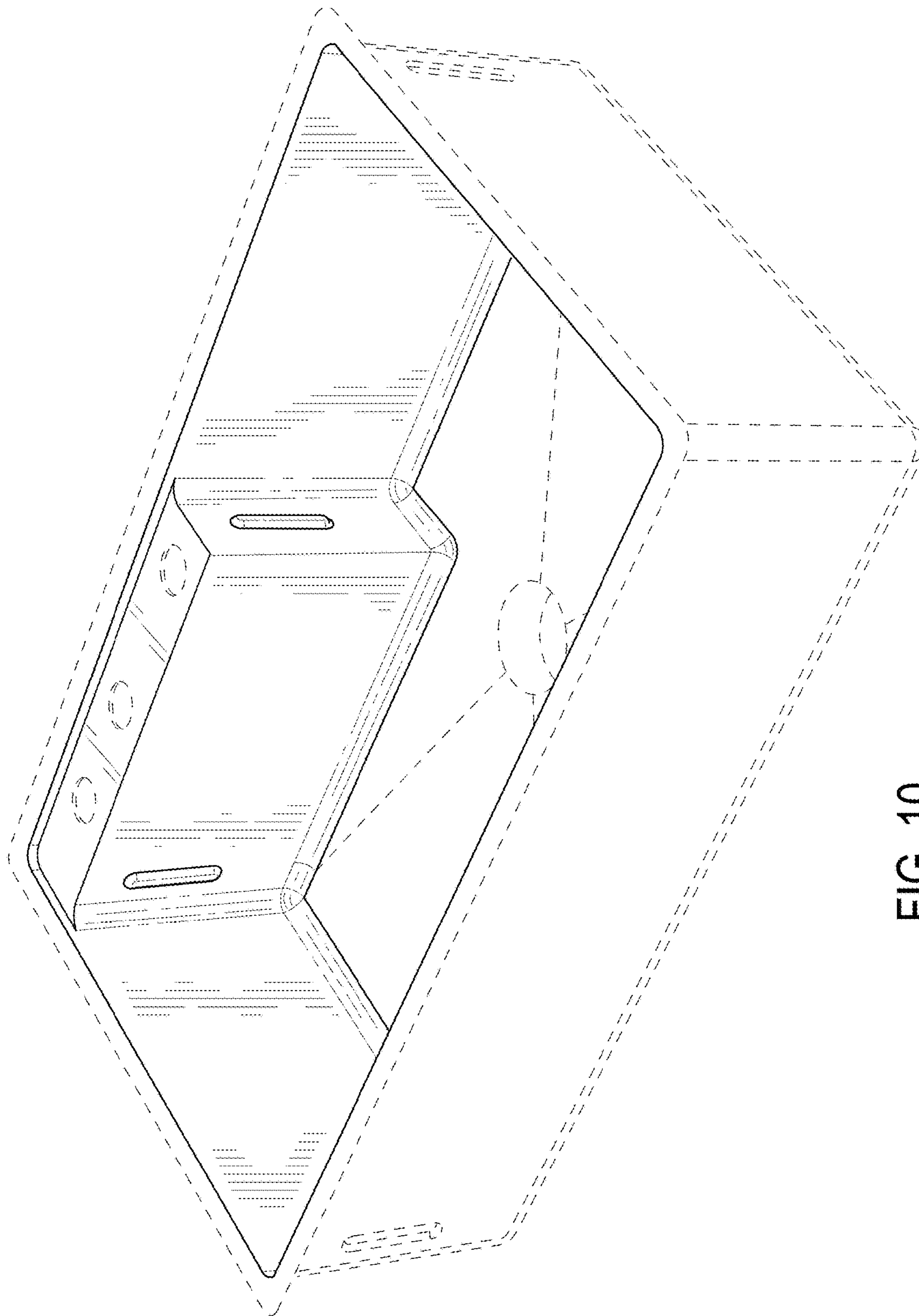

FIG. 10

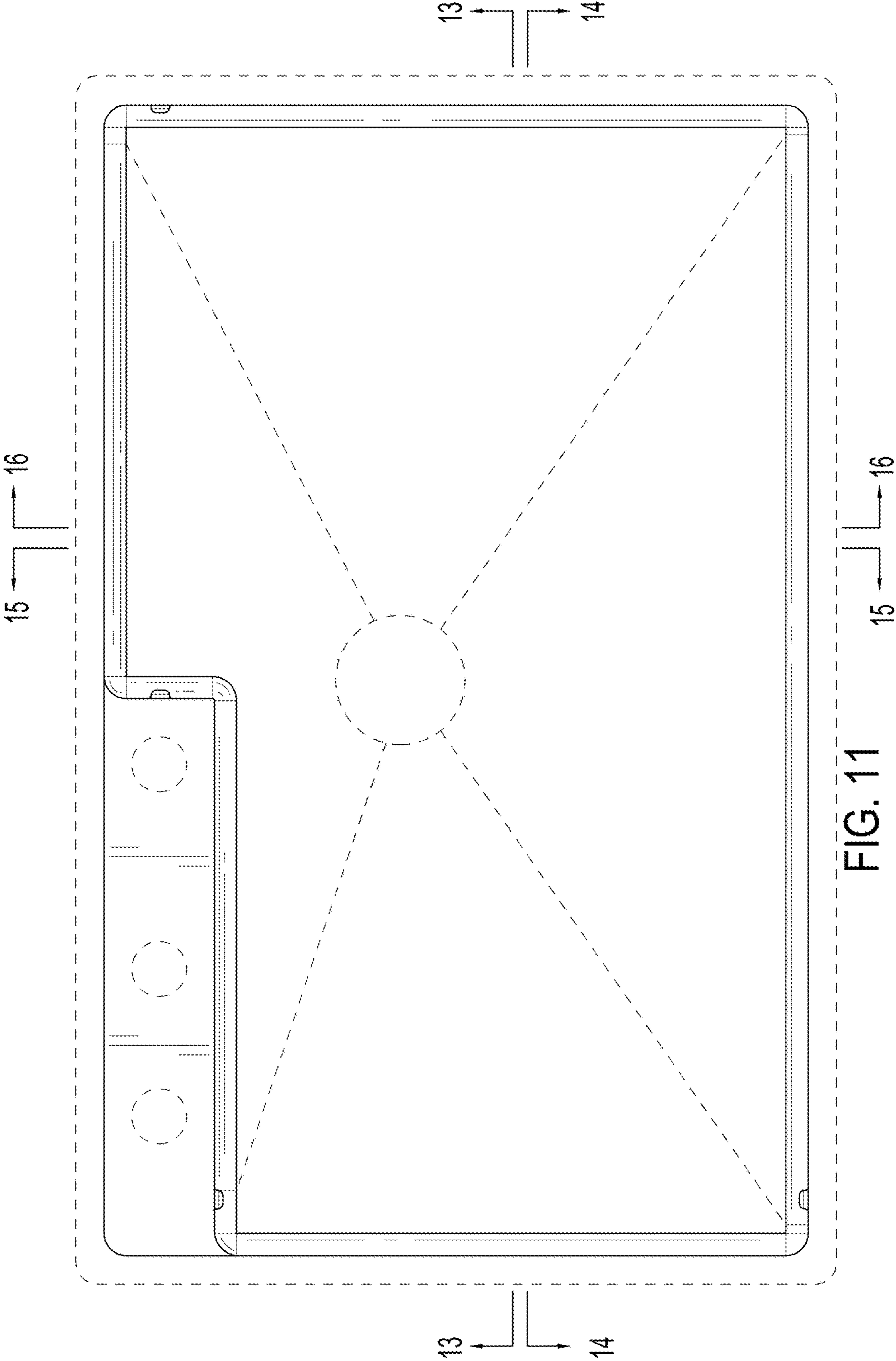

FIG. 11

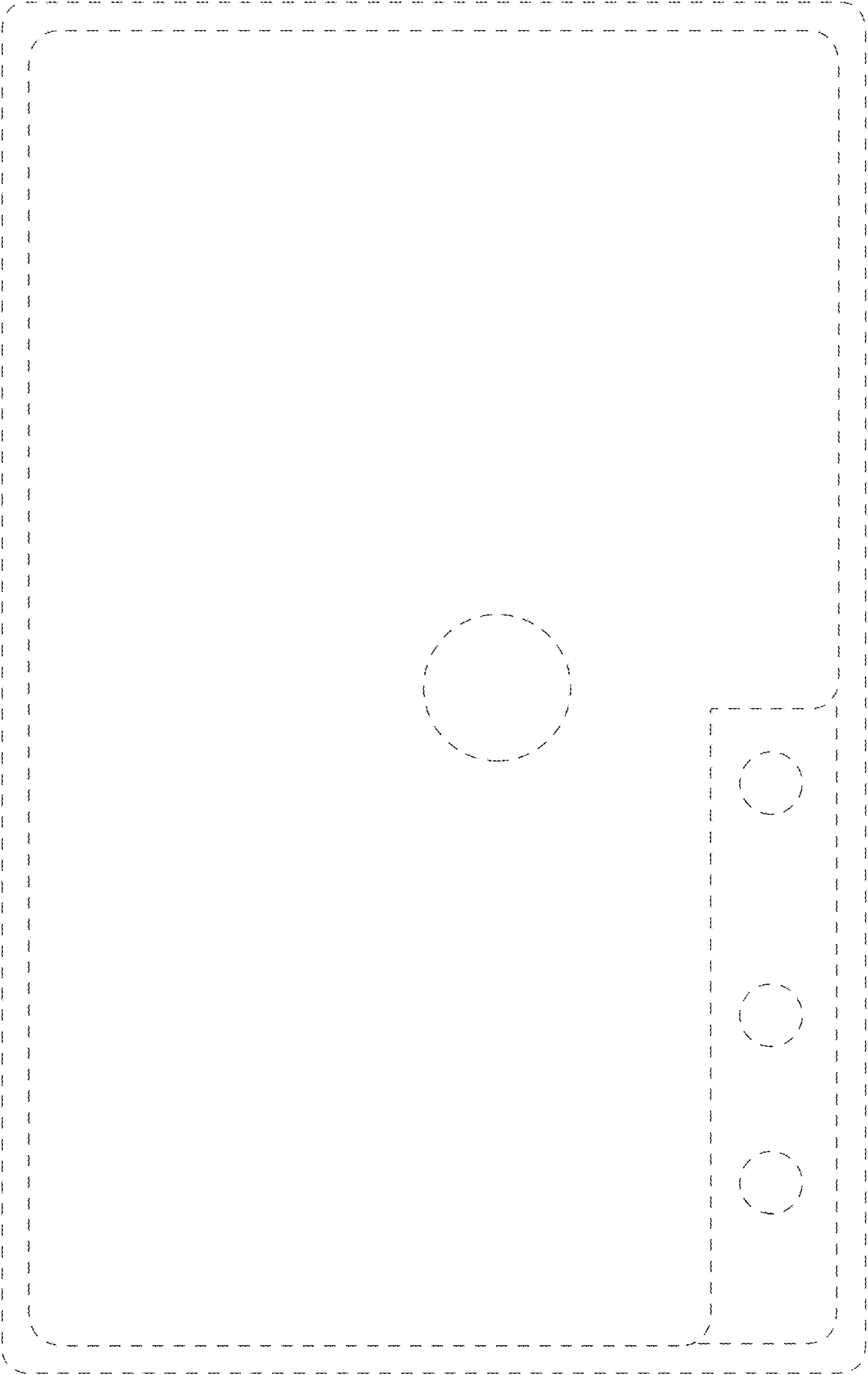

FIG. 12

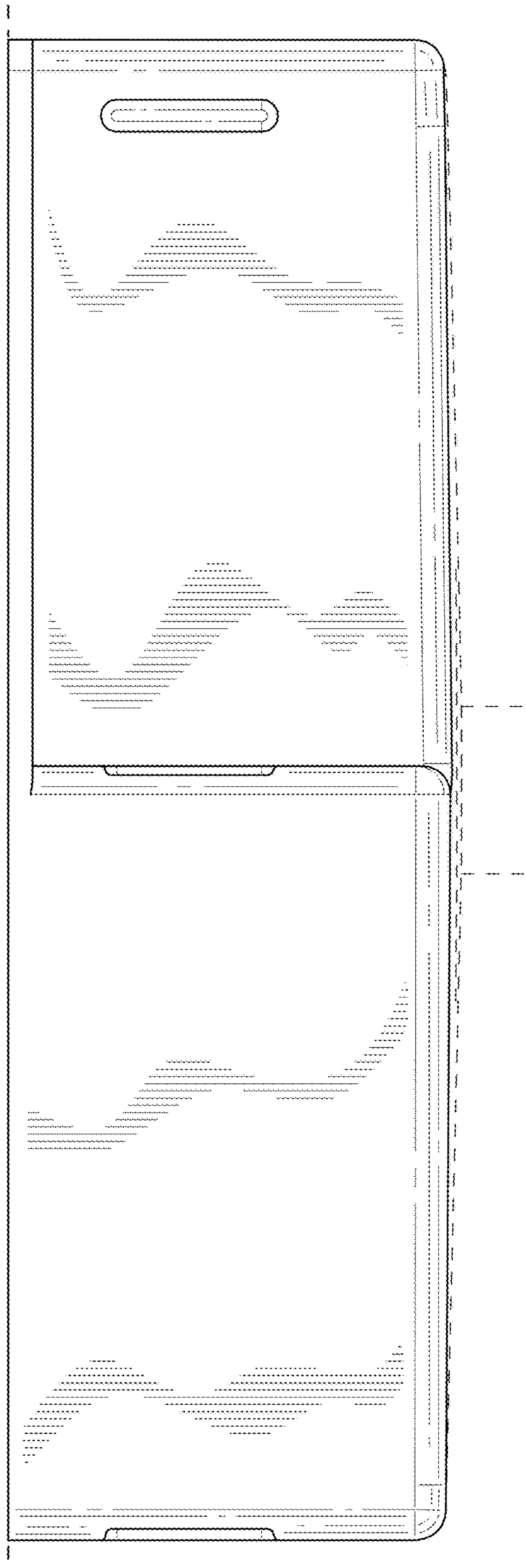

FIG. 13

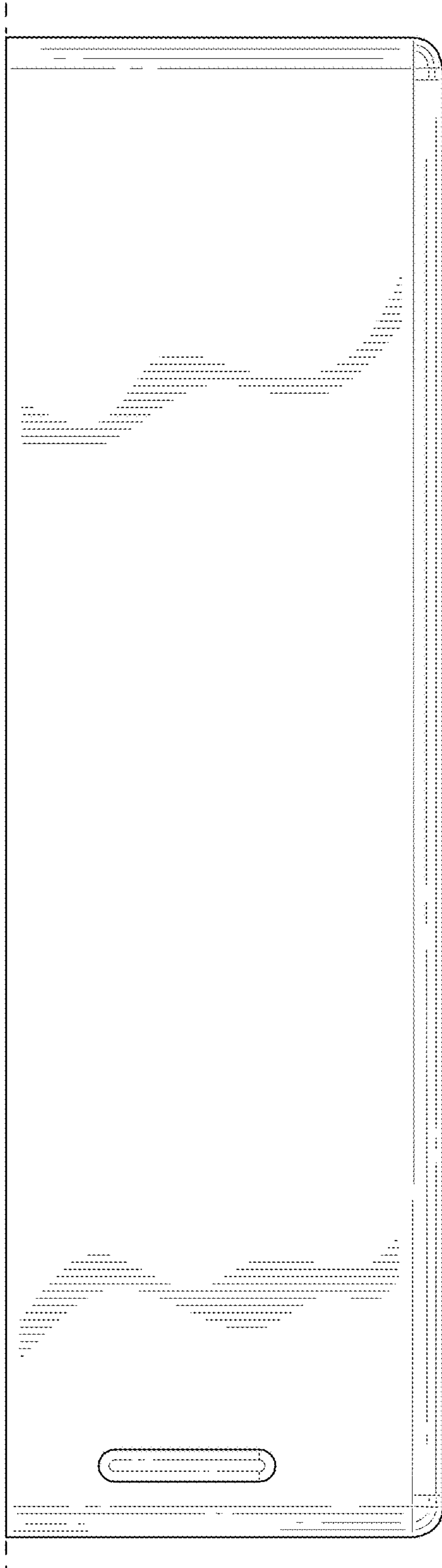

FIG. 14

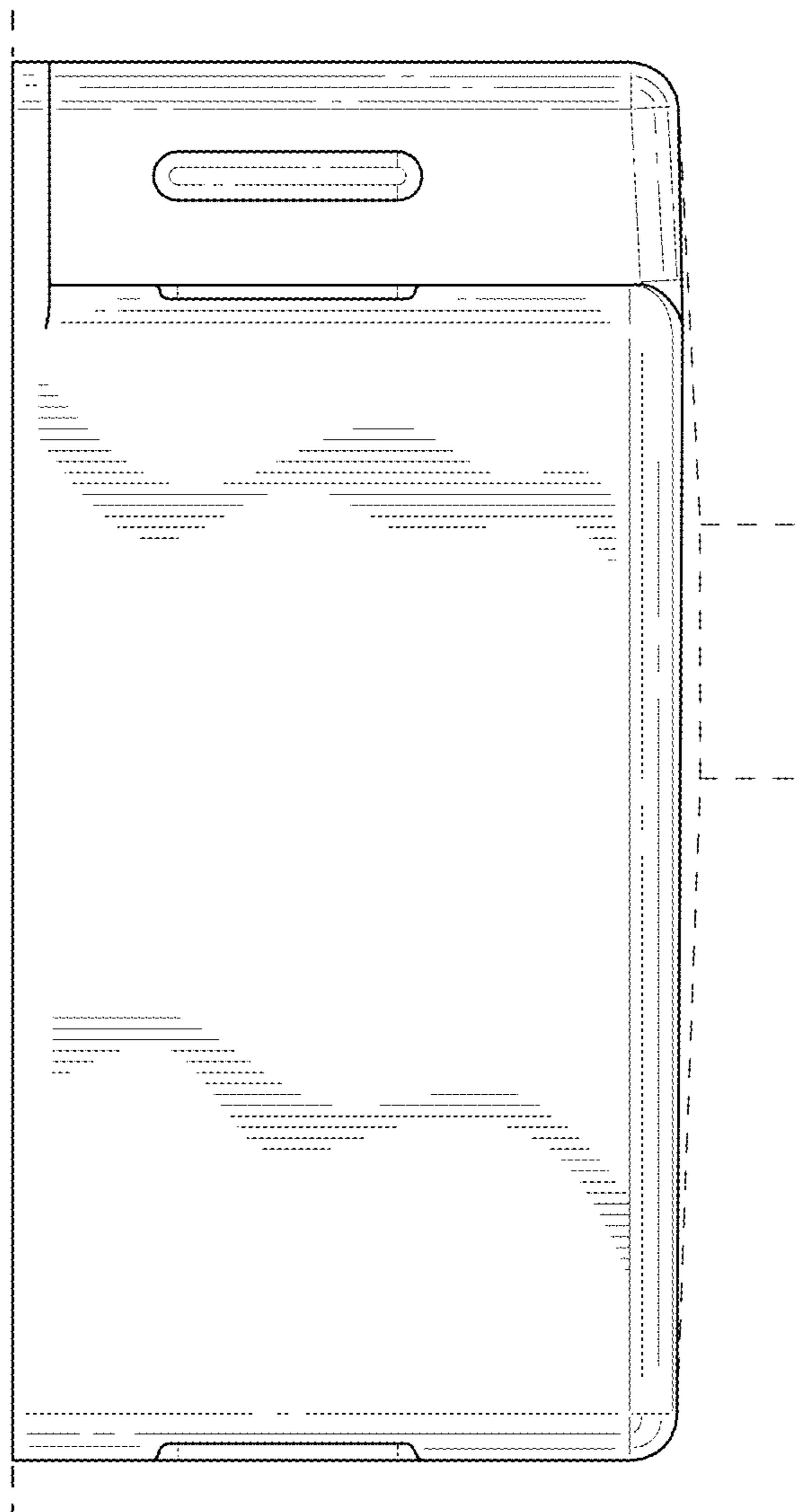

FIG. 15

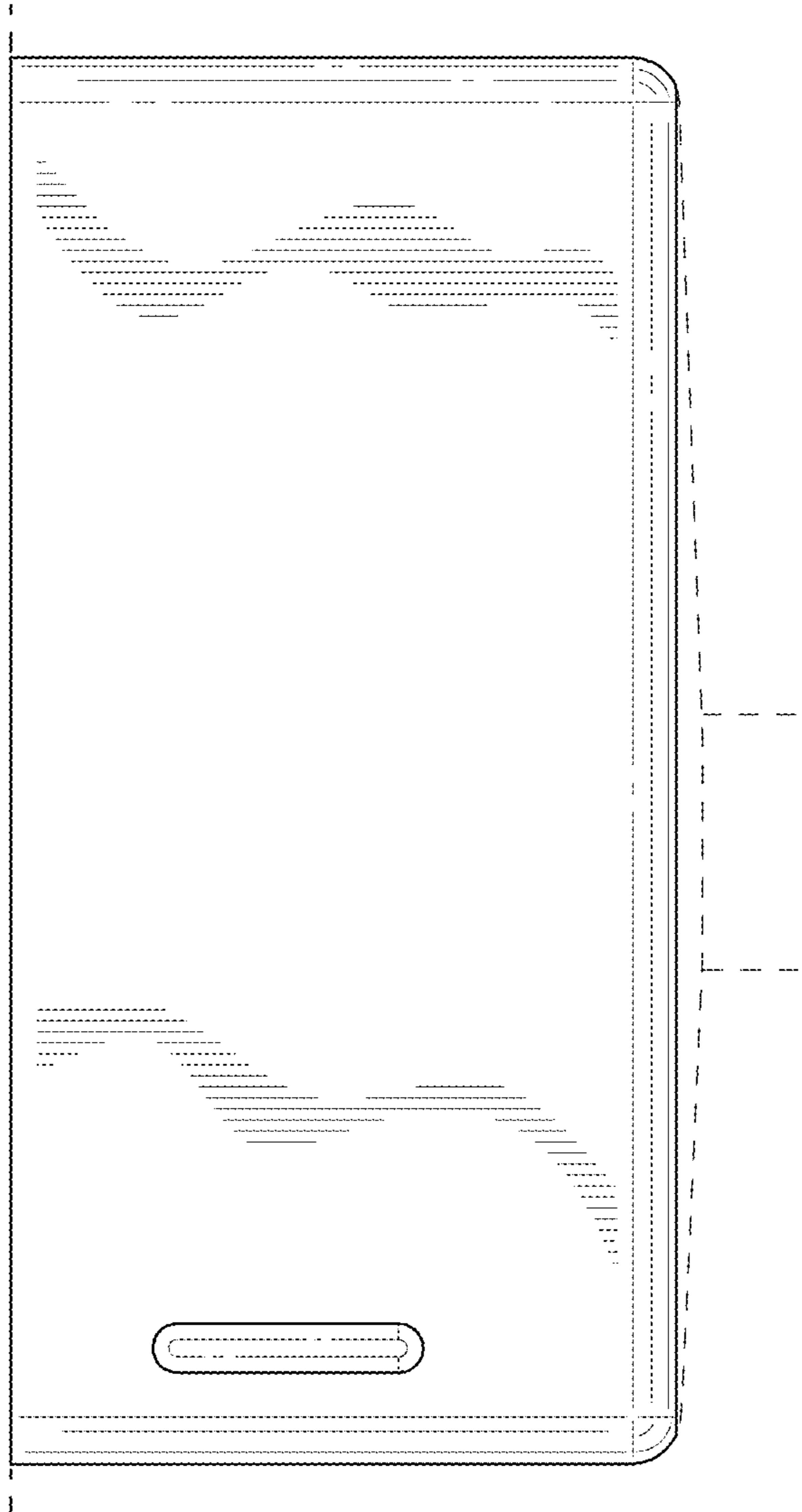

FIG. 16