



US00D799488S

(12) **United States Design Patent**
Nishizawa

(10) **Patent No.:** **US D799,488 S**

(45) **Date of Patent:** **** Oct. 10, 2017**

(54) **COORDINATE INPUT INSTRUMENT**

(71) Applicant: **Wacom Co., Ltd.**, Kazo-shi, Saitama (JP)

(72) Inventor: **Naoya Nishizawa**, Setagaya-ku (JP)

(73) Assignee: **Wacom Co., Ltd.**, Kazo-shi (JP)

(**) Term: **15 Years**

(21) Appl. No.: **29/554,502**

(22) Filed: **Feb. 11, 2016**

(30) **Foreign Application Priority Data**

Aug. 20, 2015 (JP) 2015-018274

(51) **LOC (10) Cl.** **14-02**

(52) **U.S. Cl.**
USPC **D14/411**

(58) **Field of Classification Search**
USPC D14/372, 496, 432, 371, 125, 126, 129,
D14/299, 411; D16/300-342; 351/158,
351/153, 144; 345/7-9, 905; 455/344;
348/115, 53, 121, 739

CPC G02B 27/017; G06F 3/016; G06F 3/033;
G06F 3/0317; G06F 3/03545; G06F
3/041; G06K 9/222

See application file for complete search history.

(56) **References Cited**

U.S. PATENT DOCUMENTS

4,712,937 A * 12/1987 Schmidt B43K 5/14
401/199
D310,684 S * 9/1990 Itoh D19/195
D317,625 S * 6/1991 Itoh D19/195
D340,069 S * 10/1993 Garry D19/195
D352,703 S * 11/1994 Mitcham D14/411
D487,746 S * 3/2004 Fitch D14/411
D487,896 S * 3/2004 Tanner, Jr. D14/403

D573,644 S * 7/2008 Bhavnani D19/195
D610,145 S * 2/2010 Smith D14/411
8,368,670 B2 * 2/2013 Liang G06F 3/03545
178/19.01
D681,038 S * 4/2013 Tomohiro D14/411
D720,349 S * 12/2014 Comerford D14/411
D722,600 S * 2/2015 Dowd D14/411
D724,087 S * 3/2015 Sakatsume D14/411
D744,486 S * 12/2015 Arai D14/411
D754,661 S * 4/2016 Nishizawa D14/411
D772,876 S * 11/2016 Akana D14/411
D783,022 S * 4/2017 Sirota D14/411

FOREIGN PATENT DOCUMENTS

JP D1513748 S 12/2014

* cited by examiner

Primary Examiner — Austin Murphy

(74) *Attorney, Agent, or Firm* — Christensen O'Connor Johnson; Brandon Stallman

(57) **CLAIM**

The ornamental design for a coordinate input instrument, as shown and described.

DESCRIPTION

FIG. 1 is a front perspective view of a coordinate input instrument according to a first embodiment of my new design;

FIG. 2 is a rear perspective view thereof;

FIG. 3 is a side view thereof, the side opposite of the side shown in FIG. 3 being a mirror image thereof and therefore not shown;

FIG. 4 is a front view thereof;

FIG. 5 is a rear view thereof;

FIG. 6 is a bottom view thereof;

FIG. 7 is a top view thereof; and,

FIG. 8 is a partial bottom perspective view thereof.

1 Claim, 5 Drawing Sheets

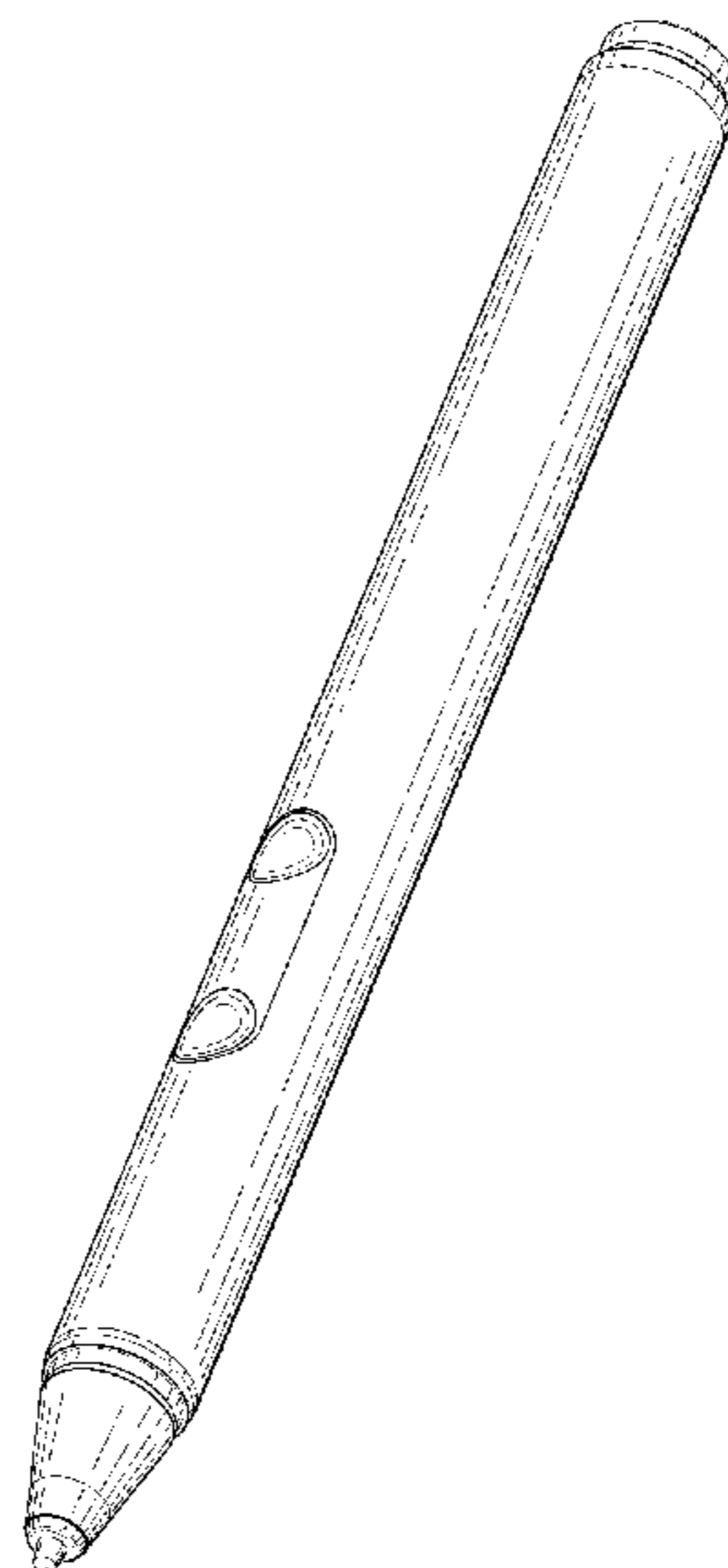

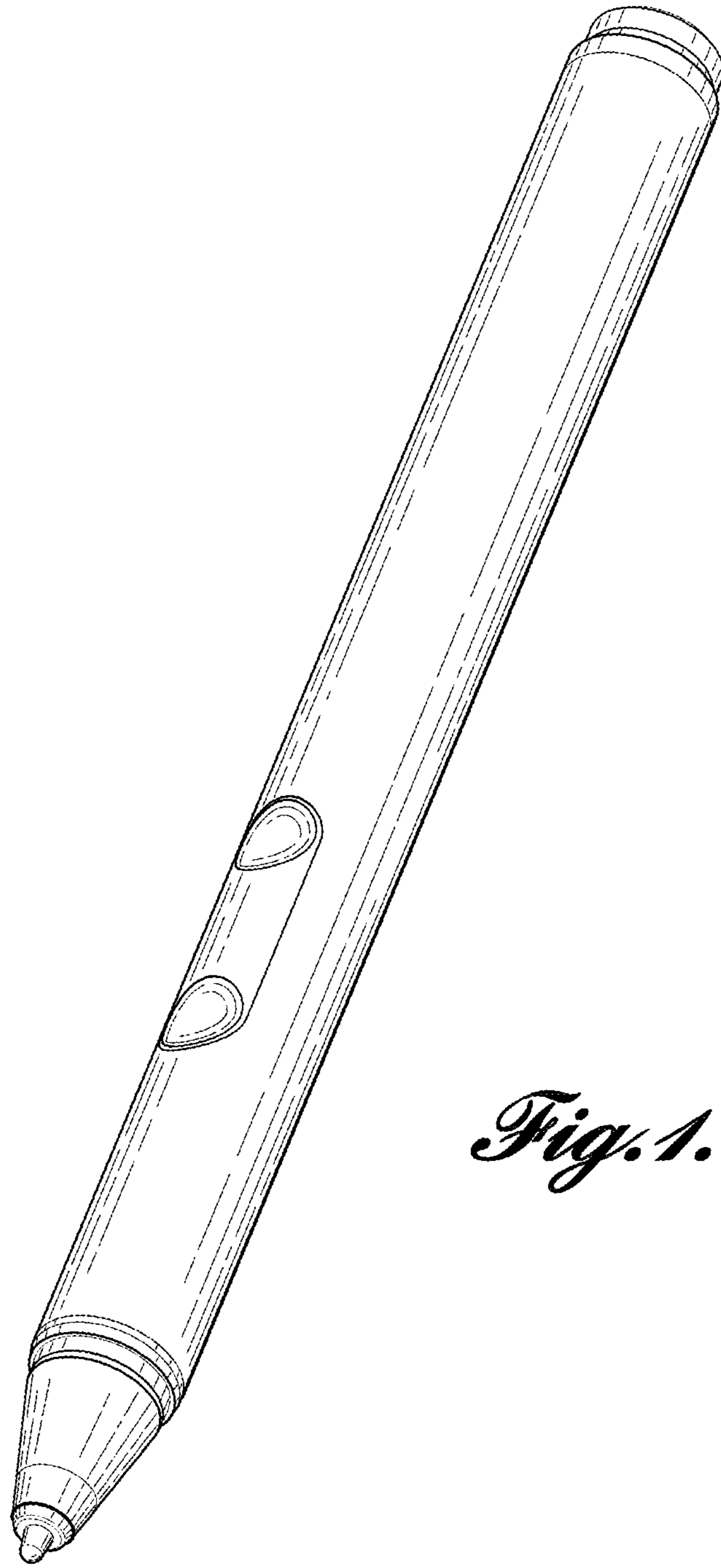

Fig. 1.

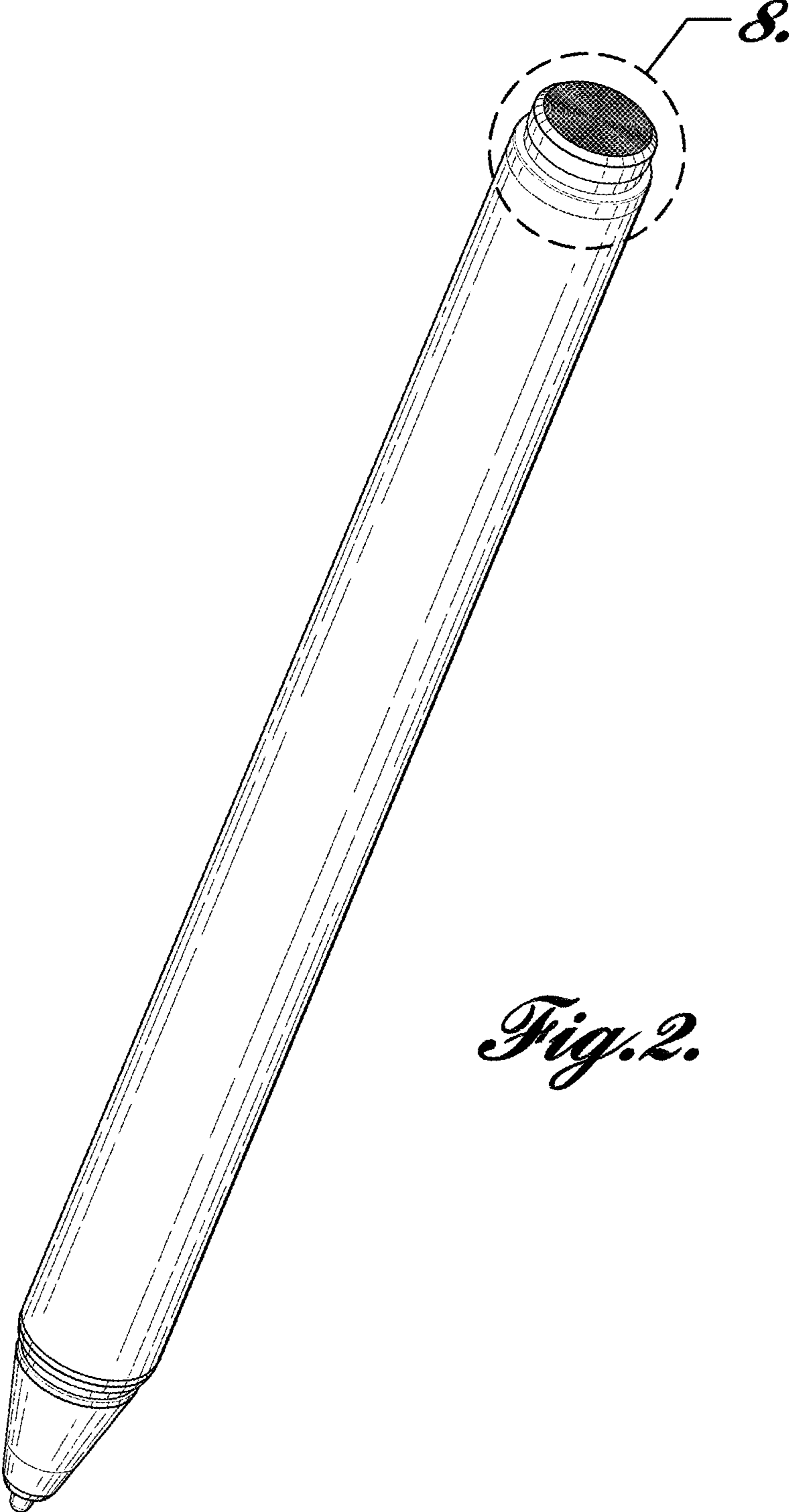

Fig. 2.

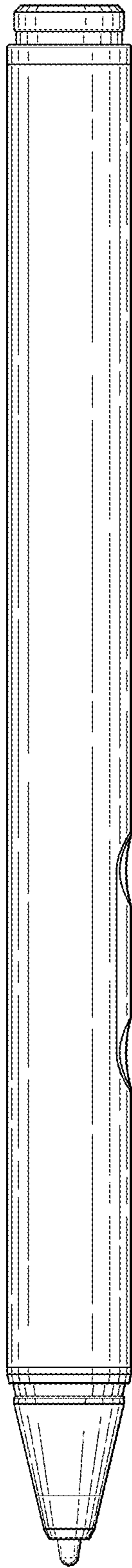

Fig. 3.

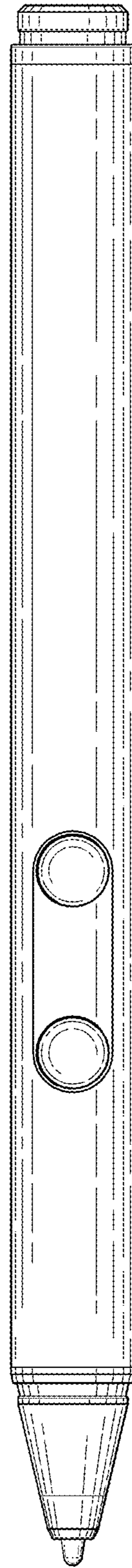

Fig. 4.

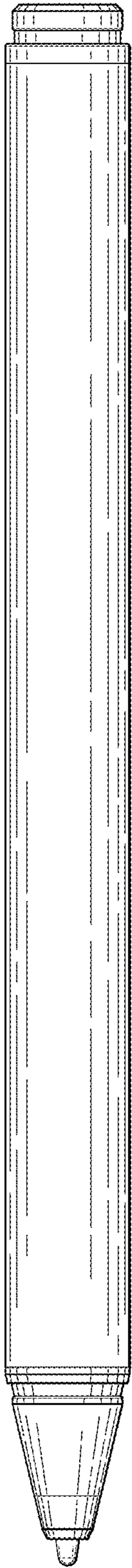

Fig. 5.

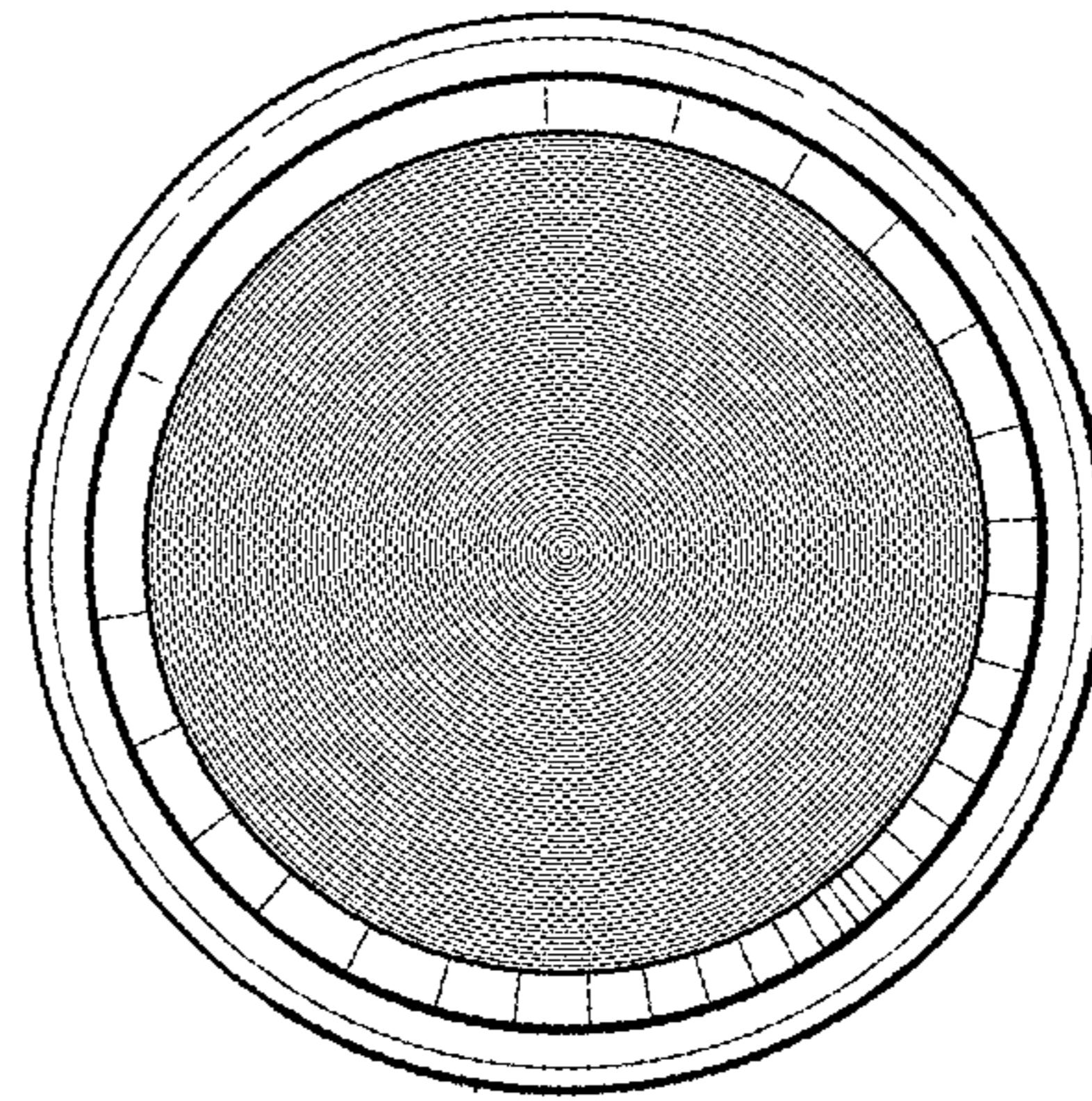

Fig. 6.

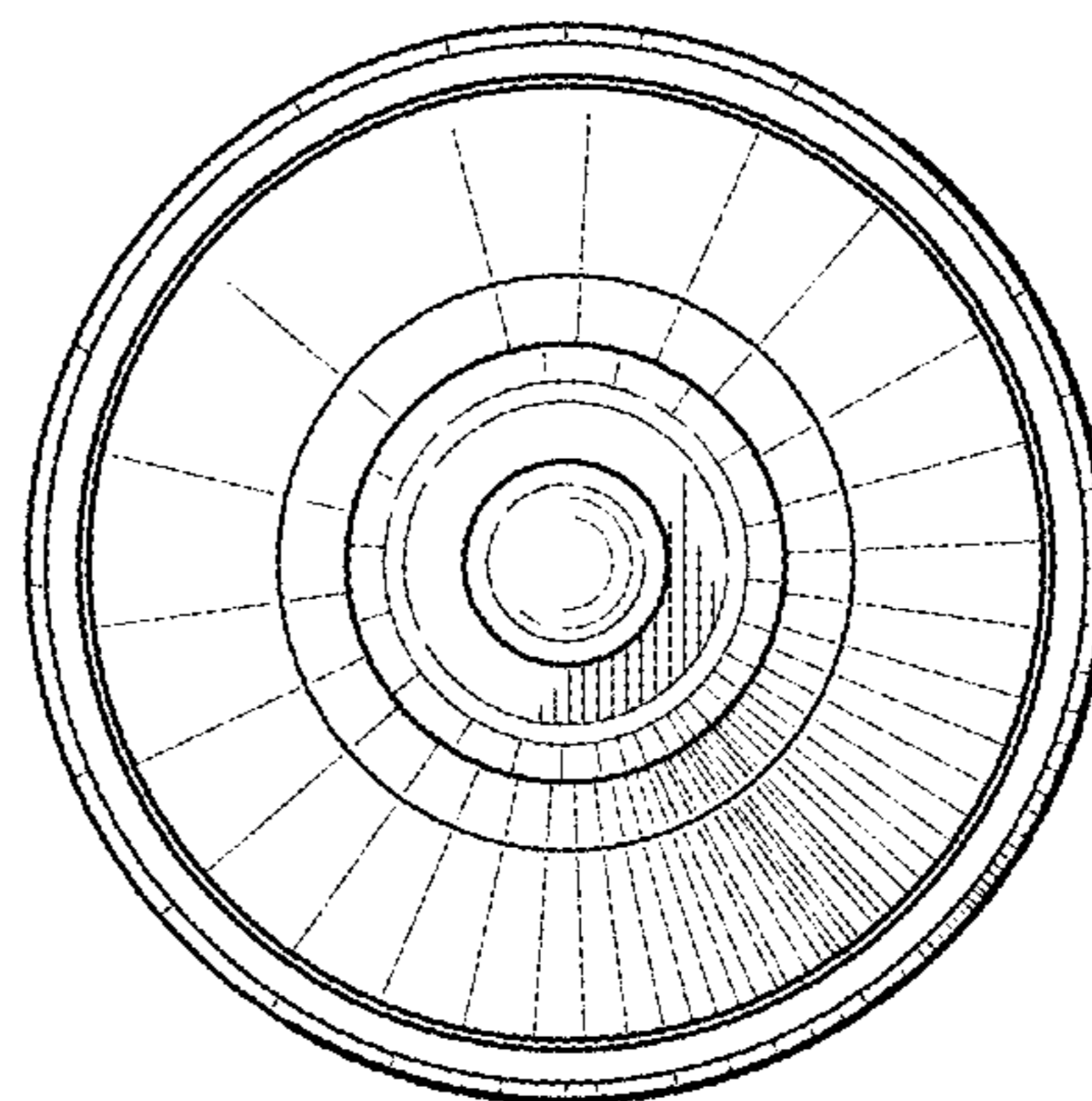

Fig. 7.

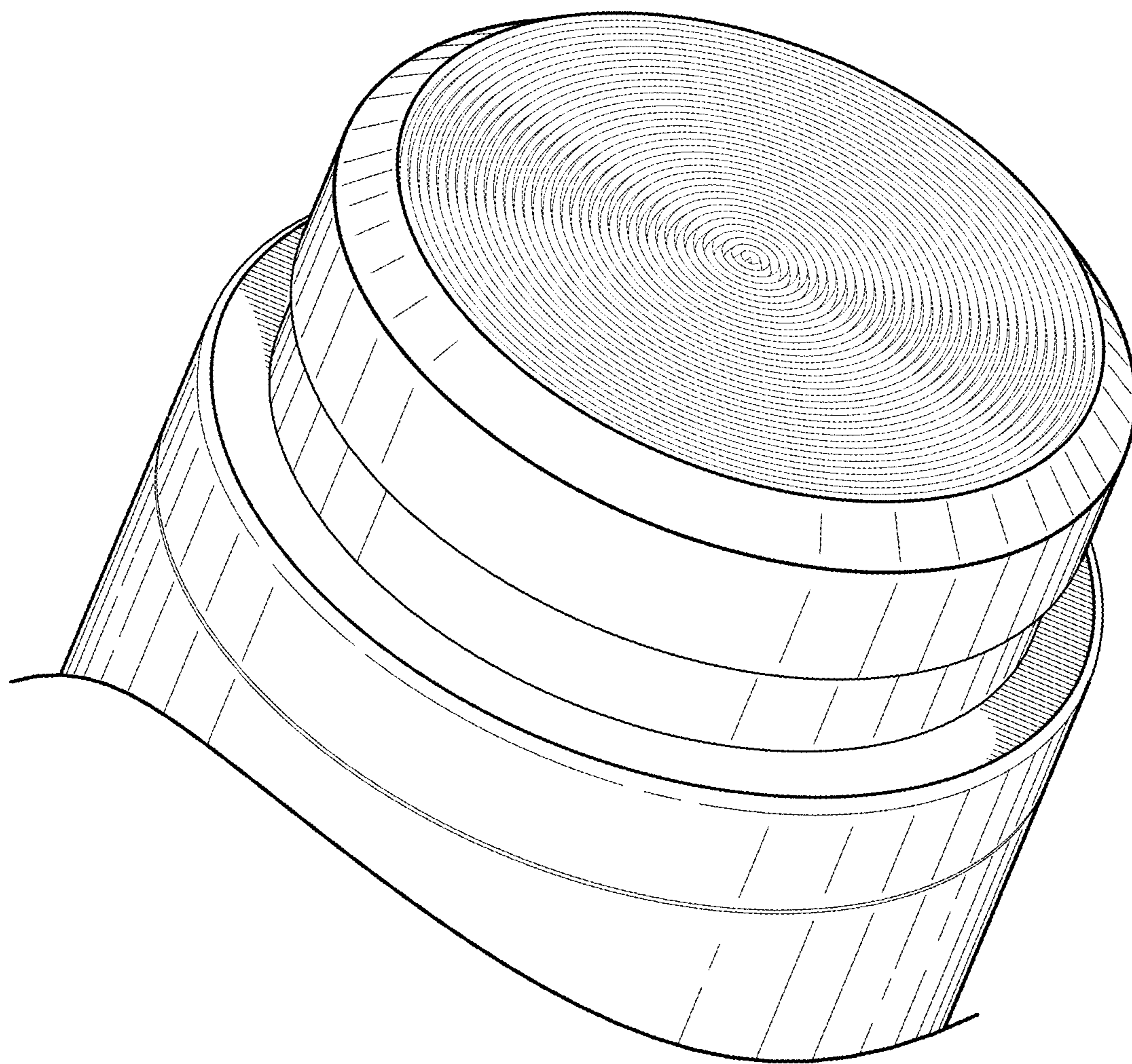

Fig. 8.