



US00D799446S

(12) **United States Design Patent**  
**Silvera**

(10) **Patent No.:** **US D799,446 S**

(45) **Date of Patent:** **\*\* Oct. 10, 2017**

(54) **BOWED DESKTOP SPEAKER**

(71) Applicant: **SDI Technologies, Inc.**, Rahway, NJ  
(US)

(72) Inventor: **Isaac Silvera**, Brooklyn, NY (US)

(73) Assignee: **SDI TECHNOLOGIES, INC.**,  
Rahway, NJ (US)

(\*\*) Term: **15 Years**

(21) Appl. No.: **29/575,239**

(22) Filed: **Aug. 23, 2016**

(51) **LOC (10) Cl.** ..... **14-01**

(52) **U.S. Cl.**  
USPC ..... **D14/214; D14/210**

(58) **Field of Classification Search**  
USPC ..... D14/168, 188, 194, 195, 196, 204, 210,  
D14/211, 212, 213, 214, 215, 216  
CPC ..... B60R 11/0217; G06F 1/1688; G10K 9/22;  
G10K 11/004; H03F 1/327; H04M 1/03;  
H04M 1/035; H04N 5/642; H04N  
21/4852; H04S 3/00; H04S 7/30; H04R  
1/02; H04R 1/06; H04R 1/021; H04R  
1/025; H04R 1/026; H04R 1/028; H04R  
1/105; H04R 1/323; H04R 1/403; H04R  
1/2803; H04R 1/2834; H04R 5/02; H04R  
7/20; H04R 9/06; H04R 9/025; H04R  
2201/021; H04R 2400/00; H04R 2400/07;  
H04R 2499/11; H04R 2499/13; H04R  
2499/15

See application file for complete search history.

(56) **References Cited**

**U.S. PATENT DOCUMENTS**

D188,326 S \* 7/1960 Levy ..... D14/214  
D210,692 S \* 4/1968 Samperi ..... D14/213  
D349,289 S \* 8/1994 Vananderoye ..... D14/217  
D356,569 S \* 3/1995 Gioscia ..... D14/210

D381,989 S \* 8/1997 Chang ..... D14/214  
D413,890 S \* 9/1999 Eberbach ..... D14/216  
D428,612 S \* 7/2000 Scorrano ..... D14/194  
D440,220 S \* 4/2001 Dunk ..... D14/211  
D464,641 S \* 10/2002 Liu ..... D14/214  
D510,735 S \* 10/2005 Murphy ..... D14/211  
D512,988 S \* 12/2005 Green ..... D14/214  
D529,469 S \* 10/2006 Rose ..... D14/138 R  
D540,784 S \* 4/2007 Yoon ..... D14/214  
D679,265 S \* 4/2013 Lee ..... D14/204  
D684,948 S \* 6/2013 Burlingame ..... D14/204  
D711,349 S \* 8/2014 Schmiedbauer ..... D14/209.1

(Continued)

**OTHER PUBLICATIONS**

YouTube—Top 5 Best iHome, announced Jul. 28, 2016 [online],  
[site visited Jun. 23, 2017]. Available from internet, URL: <<https://www.youtube.com/watch?v=E0CXn036ZZs>>.\*

(Continued)

*Primary Examiner* — Keli L Hill

*Assistant Examiner* — Karra S Johnson

(74) *Attorney, Agent, or Firm* — Leason Ellis LLP

(57) **CLAIM**

The ornamental design for a bowed desktop speaker, as shown and described.

**DESCRIPTION**

FIG. 1 is a front perspective view of a bowed desktop speaker according to my new design; FIG. 2 is a front view of the design of FIG. 1; FIG. 3 is a rear view of the design of FIG. 1; FIG. 4 is a left side view of the design of FIG. 1; FIG. 5 is a right side view of the design of FIG. 1; FIG. 6 is a top view of the design of FIG. 1; and, FIG. 7 is a bottom view of the design of FIG. 1. The dash-dash broken lines, including a front surface, branding, an access panel, and the rear surface, illustrate portions of the speaker that form no part of the claimed design.

**1 Claim, 6 Drawing Sheets**

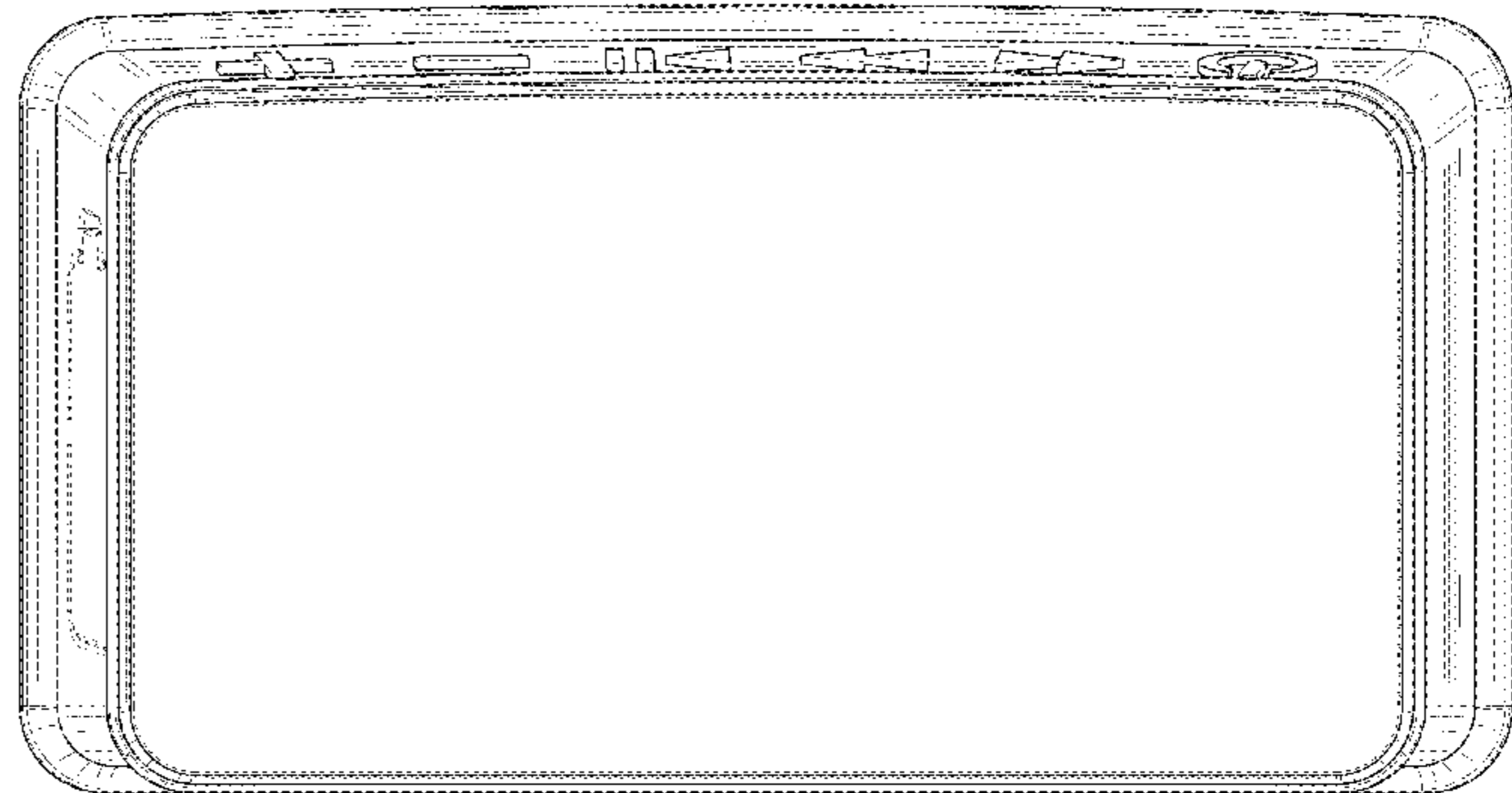
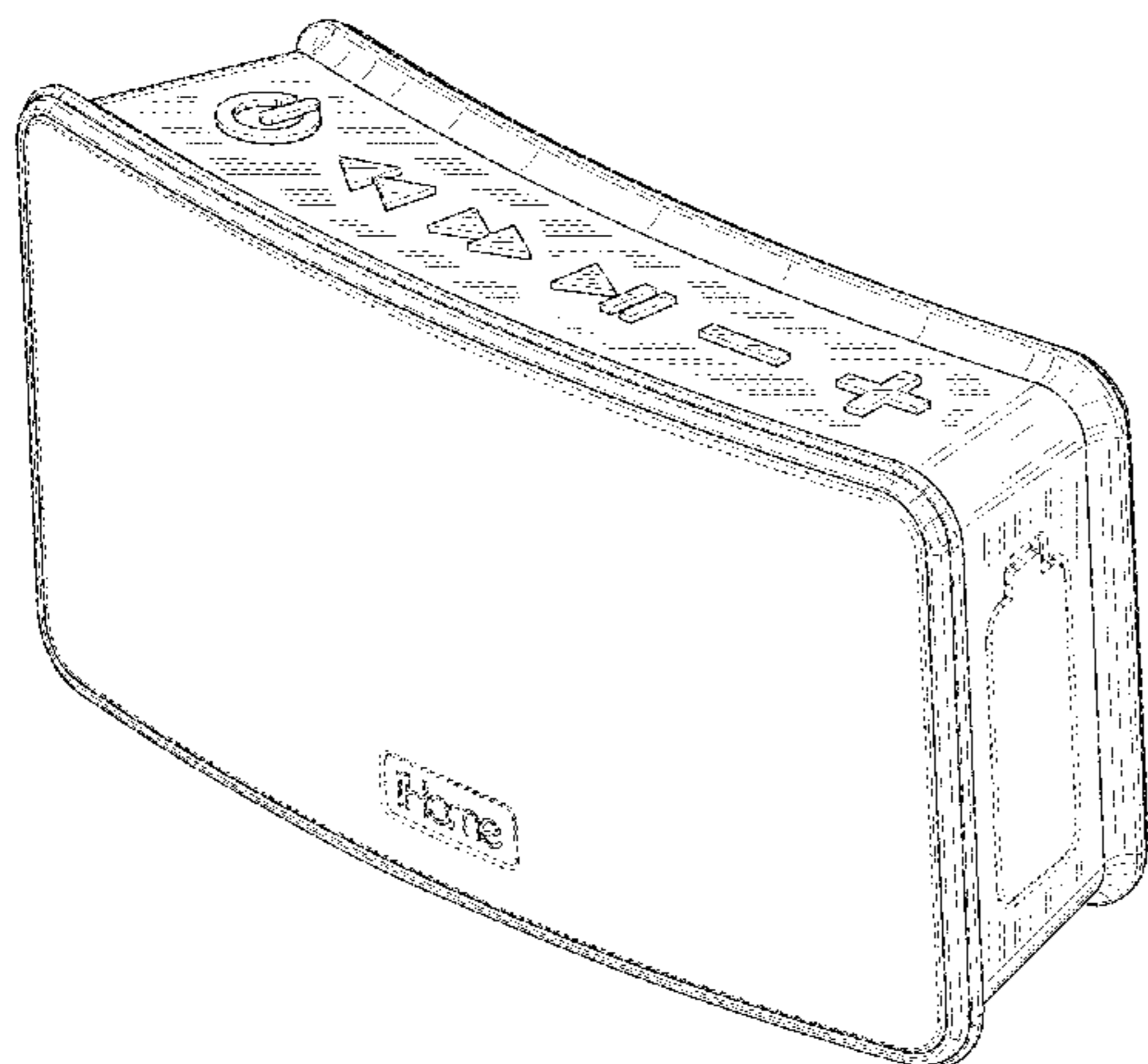

(56)

**References Cited**

U.S. PATENT DOCUMENTS

D733,678 S \* 7/2015 Gundlach ..... D14/214  
D739,380 S \* 9/2015 Bolton ..... D14/214  
D740,253 S \* 10/2015 Jeon ..... D14/204  
D756,330 S \* 5/2016 Silvera ..... D14/204

OTHER PUBLICATIONS

Daily Mail—Curved Speaker, announced Feb. 4, 2014 [online], [site visited Jun. 23, 2017]. Available from internet, URL: <<http://www.dailymail.co.uk/sciencetech/article-2551575/Heard-not-seen-The-INVISIBLE-speaker-thats-curved-sound-directions.html>>.\*

Amazon—JBL CONTROLCRV, announced May 10, 2010 [online], [site visited Jun. 23, 2017]. Available from internet, URL: <[https://www.amazon.com/JBL-CONTROLCRV-WH-Outdoor-Professional-Loudspeaker/dp/B003MQMEFS/ref=pd\\_lpo\\_sbs\\_267\\_t\\_0?\\_encoding=UTF8&psc=1&refRID=C1WNPMT26YW85GCHRNS3](https://www.amazon.com/JBL-CONTROLCRV-WH-Outdoor-Professional-Loudspeaker/dp/B003MQMEFS/ref=pd_lpo_sbs_267_t_0?_encoding=UTF8&psc=1&refRID=C1WNPMT26YW85GCHRNS3)>.\*

\* cited by examiner

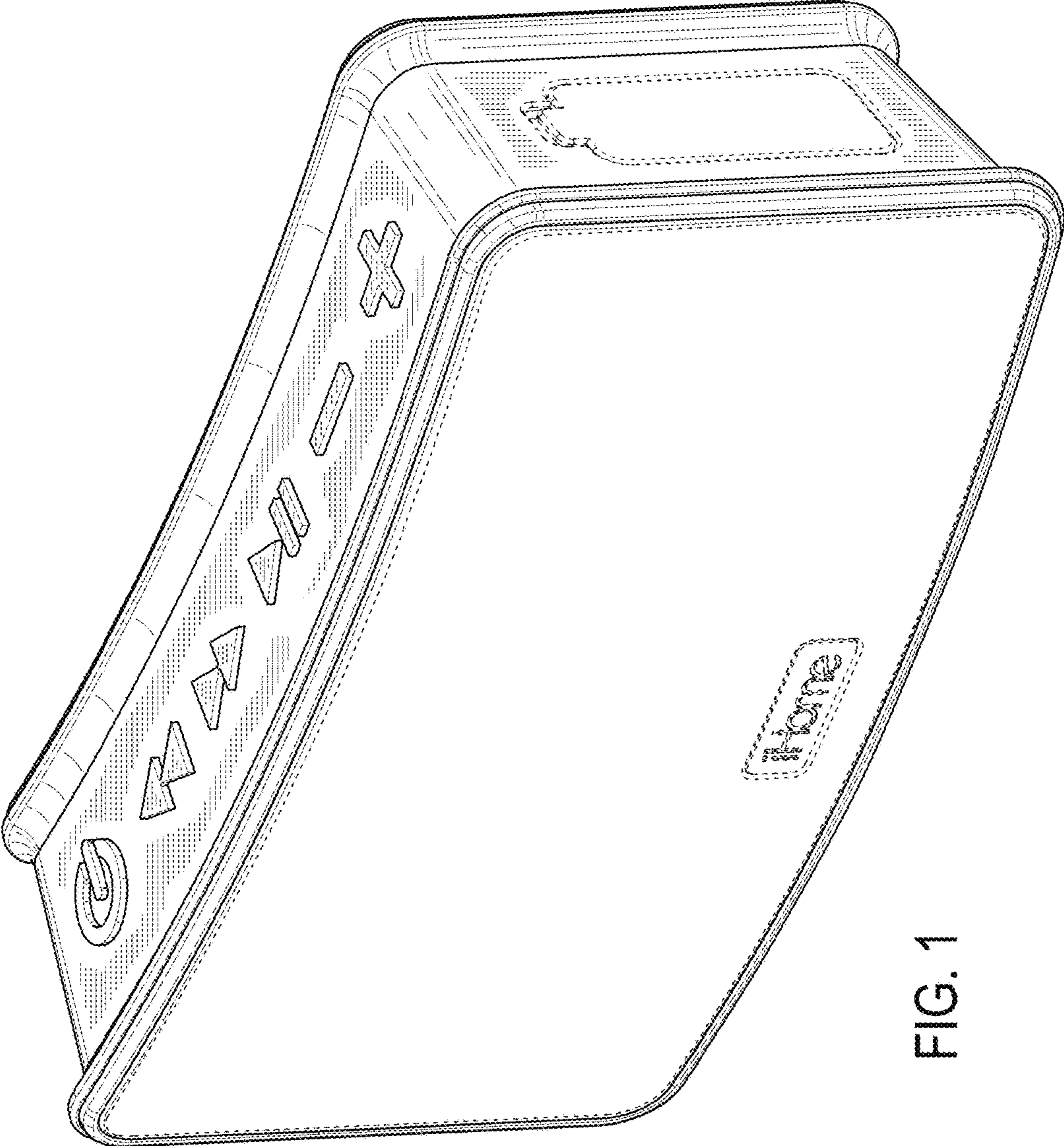

FIG. 1

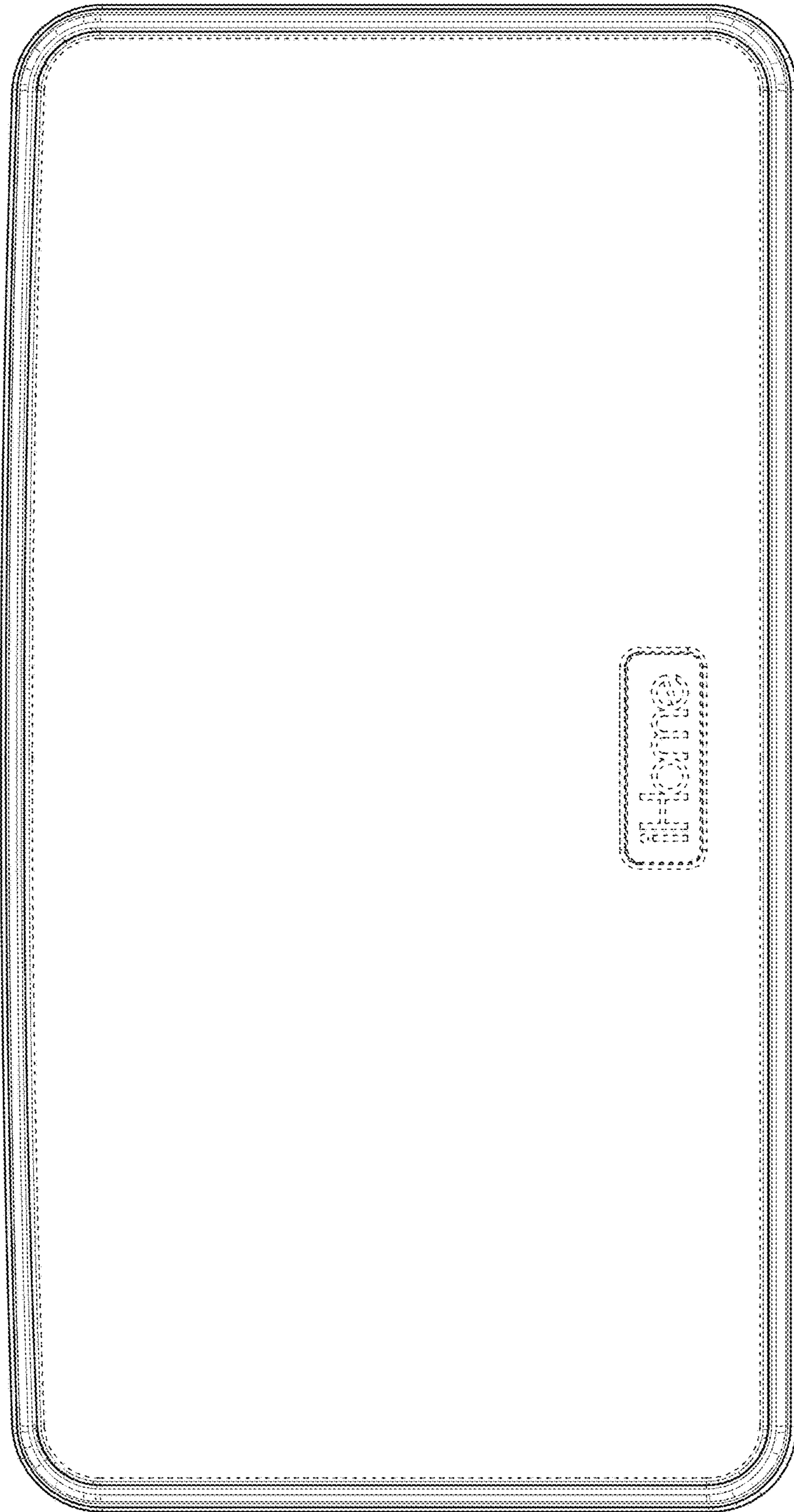

FIG. 2

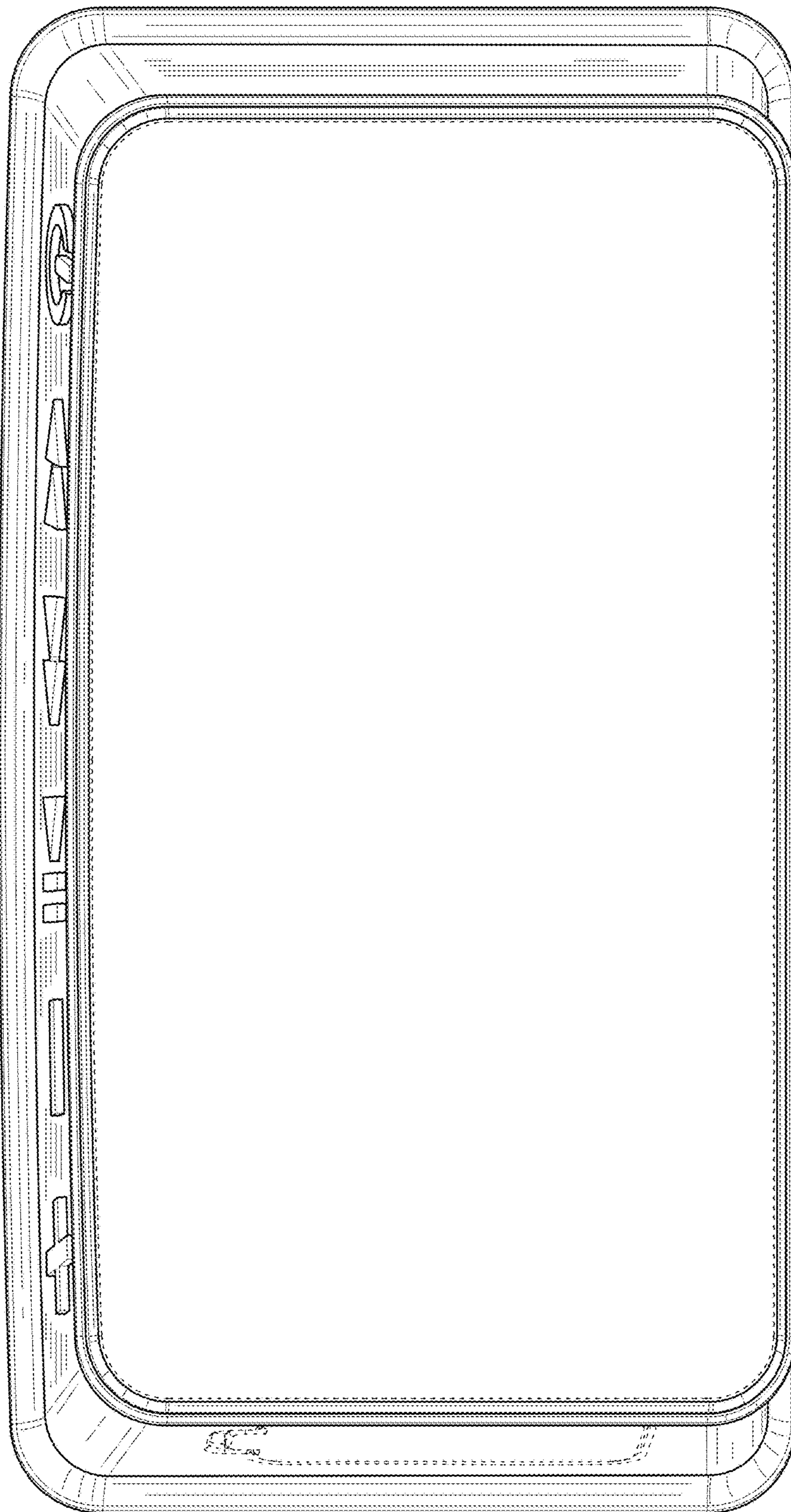

FIG. 3

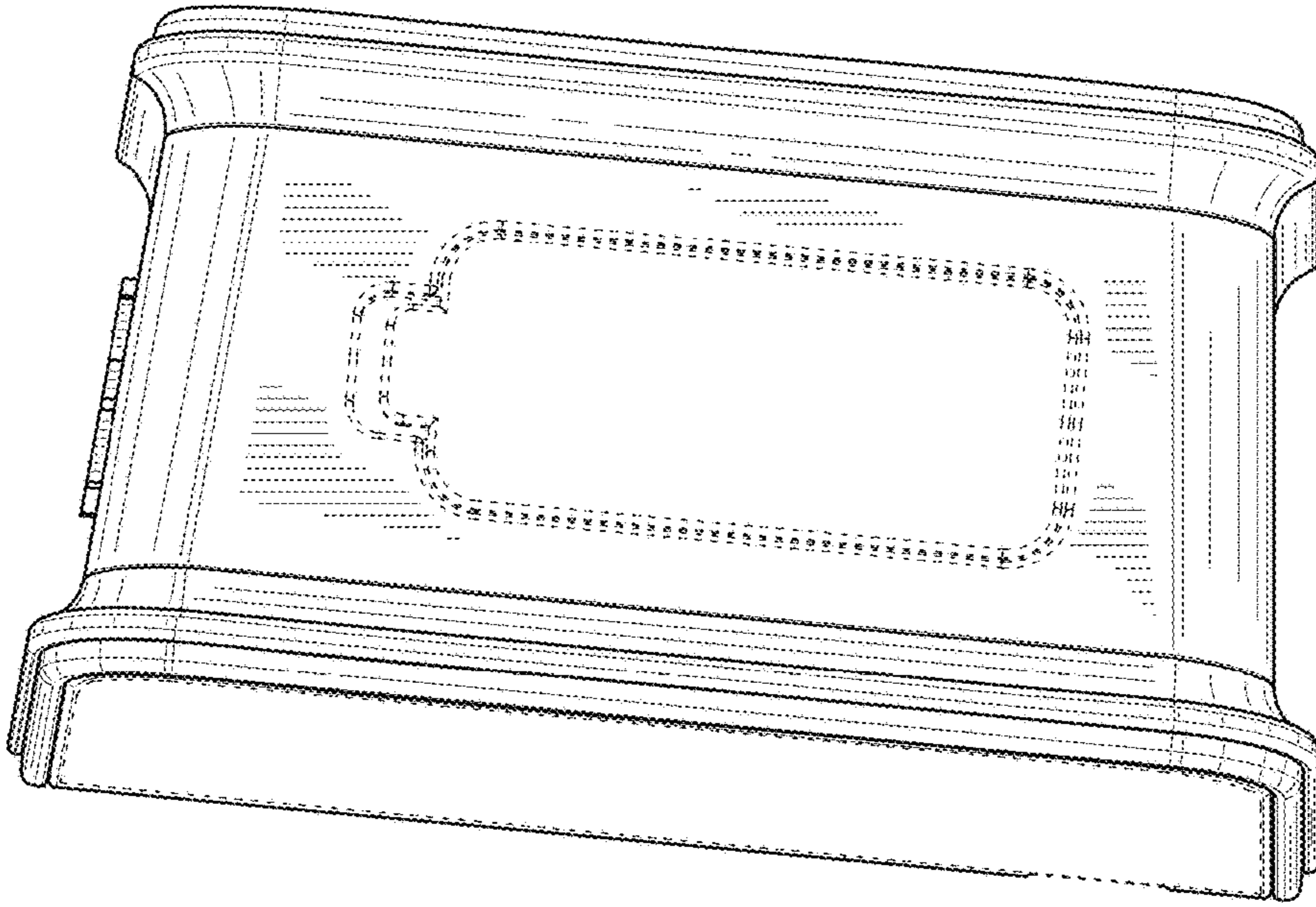

FIG. 5

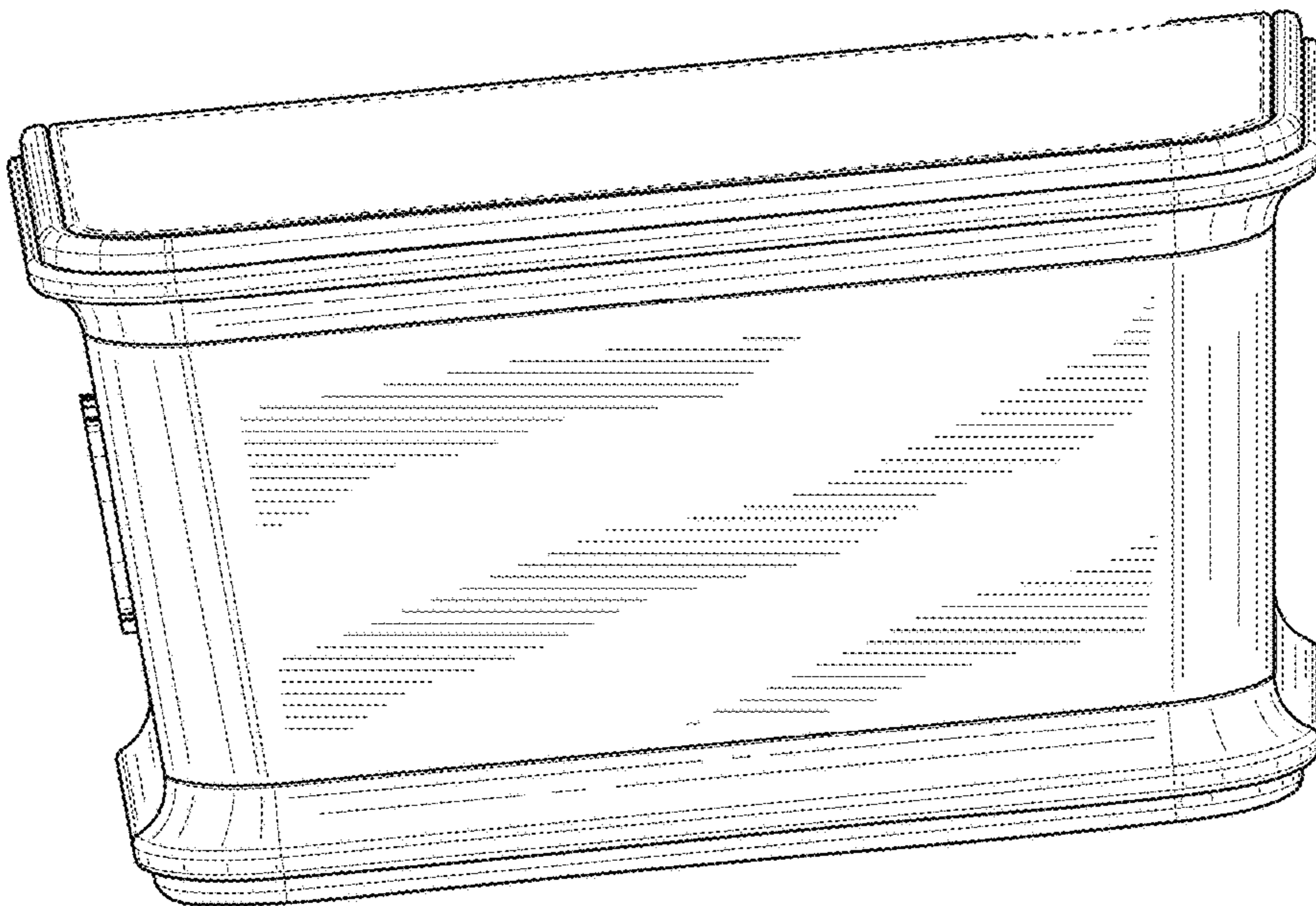

FIG. 4

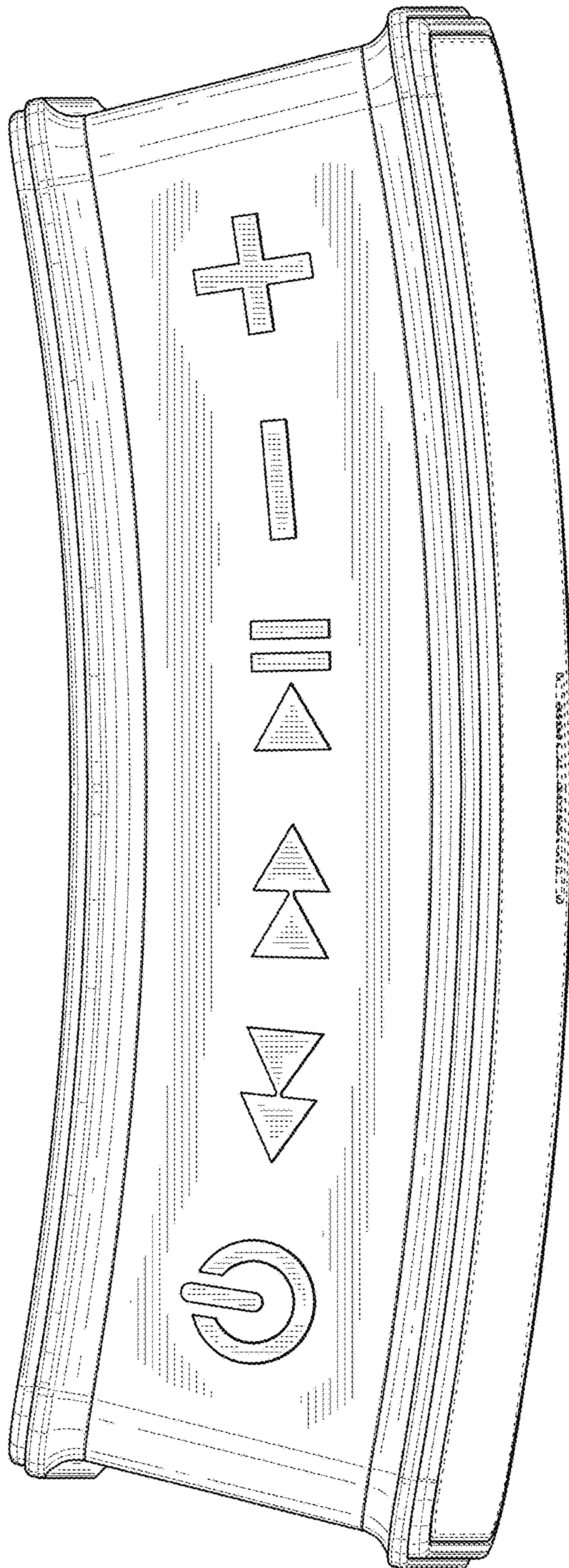

FIG. 6

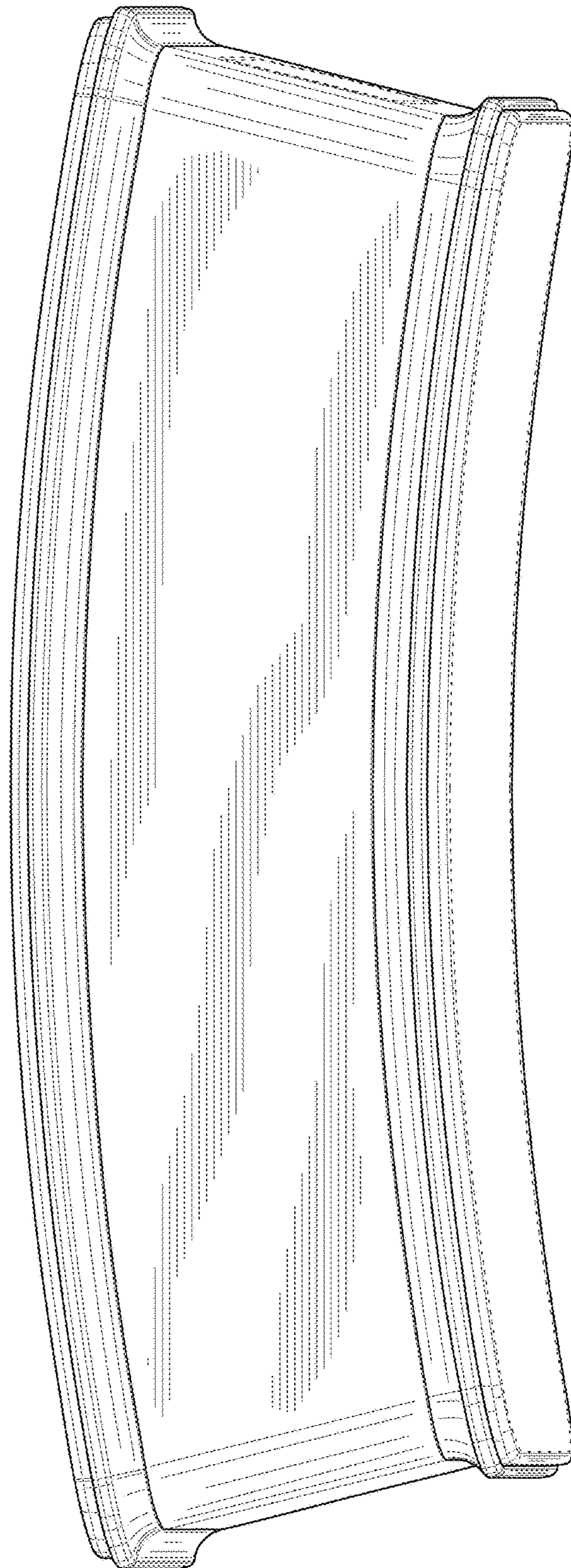

FIG. 7