



US00D799419S

(12) **United States Design Patent** (10) **Patent No.:** **US D799,419 S**
Davies (45) **Date of Patent:** **** Oct. 10, 2017**

(54) **SOLAR ENERGY COLLECTOR**
(71) Applicant: **Intex Holdings Pty Ltd**, Elizabeth Vale (AU)
(72) Inventor: **Roger Philip Davies**, Medindie Gardens (AU)
(73) Assignee: **Intex Holdings Pty Ltd**, Elizabeth Vale (AU)

(**) Term: **14 Years**
(21) Appl. No.: **29/500,278**

(22) Filed: **Aug. 22, 2014**

(30) **Foreign Application Priority Data**

Feb. 24, 2014 (AU) 201410817

(51) **LOC (10) Cl.** **13-02**

(52) **U.S. Cl.**
USPC **D13/102**

(58) **Field of Classification Search**
USPC D13/102, 101, 118, 119, 184, 199;
52/173.3; 126/569, 600, 669, 704;
136/243-265; 359/850, 851, 852;
385/144, 900
CPC H01L 31/04; H01L 31/18; H01L 31/026;
H01L 31/042; H01L 31/048; H01L
31/052; H01L 31/0216; H01L 31/0422;
E04H 12/20; F24J 2/38; F24J 2/52; F24J
2/526; F24J 2/541; F24J 2/5233; F24J
2/5252; Y02E 10/47; Y02E 10/50; H02S
20/00

See application file for complete search history.

(56) **References Cited**

U.S. PATENT DOCUMENTS

D280,500 S * 9/1985 Brooks, Jr. 174/136
5,228,924 A * 7/1993 Barker F24J 2/541
136/246

7,230,819 B2 * 6/2007 Muchow F03D 9/007
307/22
D631,004 S * 1/2011 Johnson D13/102
D649,930 S * 12/2011 Lindor D13/102
D679,242 S * 4/2013 Conger D13/102
9,093,582 B2 * 7/2015 Hamilton H02S 20/10
2010/0236183 A1 * 9/2010 Cusson F24J 2/5207
52/645
2013/0082637 A1 * 4/2013 Eaton F24J 2/541
320/101

* cited by examiner

Primary Examiner — Derrick Holland

(74) *Attorney, Agent, or Firm* — Sand & Sebolt

(57) **CLAIM**

The ornamental design for a solar energy collector, as shown and described.

DESCRIPTION

FIG. 1 is a front, top, and right side perspective view of a solar energy collector showing my new design;
FIG. 2 is an enlarged perspective view of the highlighted region of FIG. 1 showing the front top and sides of the solar energy collector;
FIG. 3 is a right side elevation view of the solar energy collector; the left side elevation view being a mirror image thereof;
FIG. 4 is a front elevation view of the solar energy collector as shown in FIG. 2;
FIG. 5 is rear elevation view of the solar energy collector as shown in FIG. 2;
FIG. 6 is a top plan view of the solar energy collector as shown in FIG. 2; and,
FIG. 7 is a bottom plan view of the solar energy collector as shown in FIG. 2.

The broken lines shown represent unclaimed subject matter and form no part of the claimed design.

1 Claim, 7 Drawing Sheets

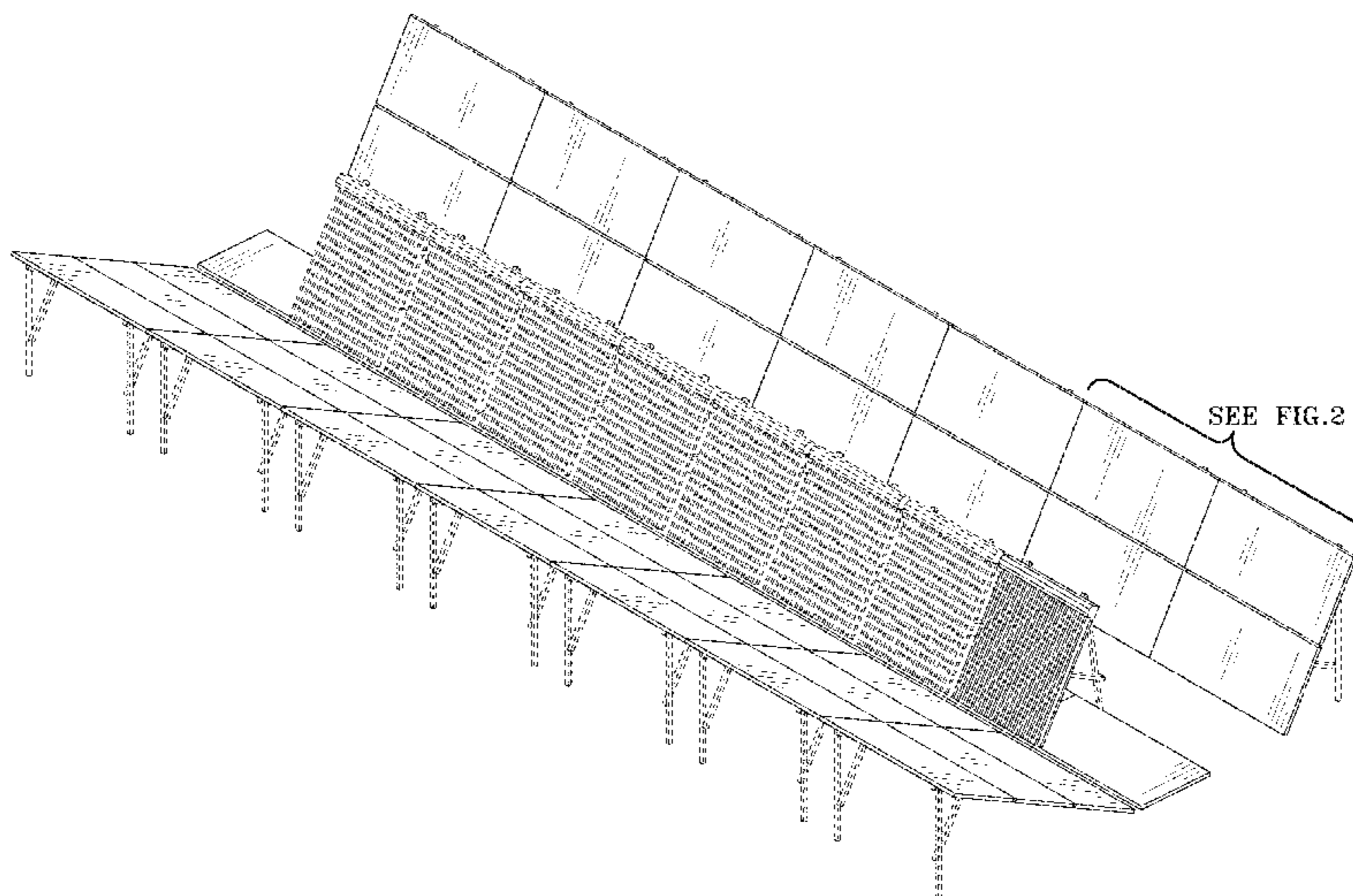

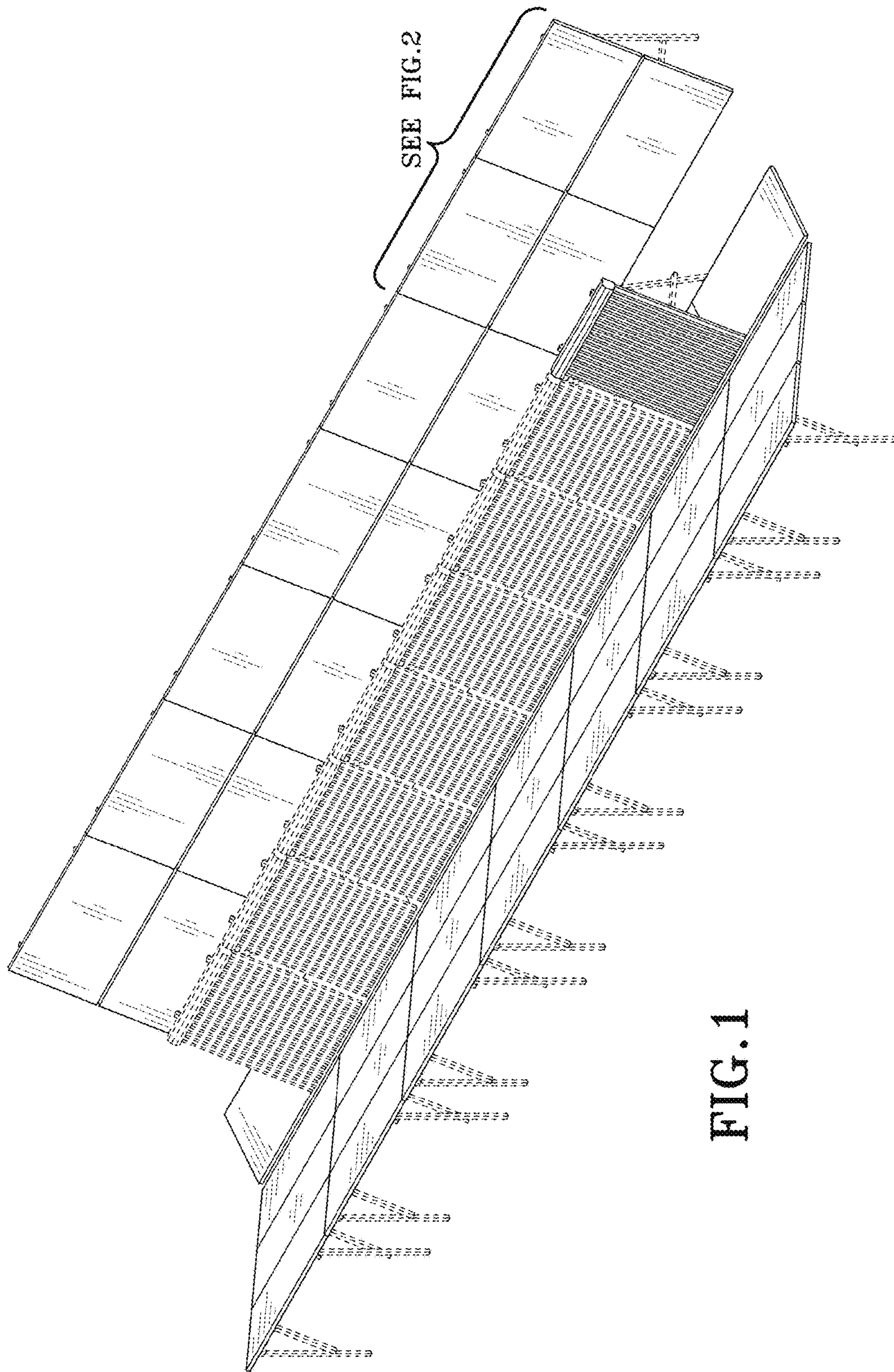

FIG. 1

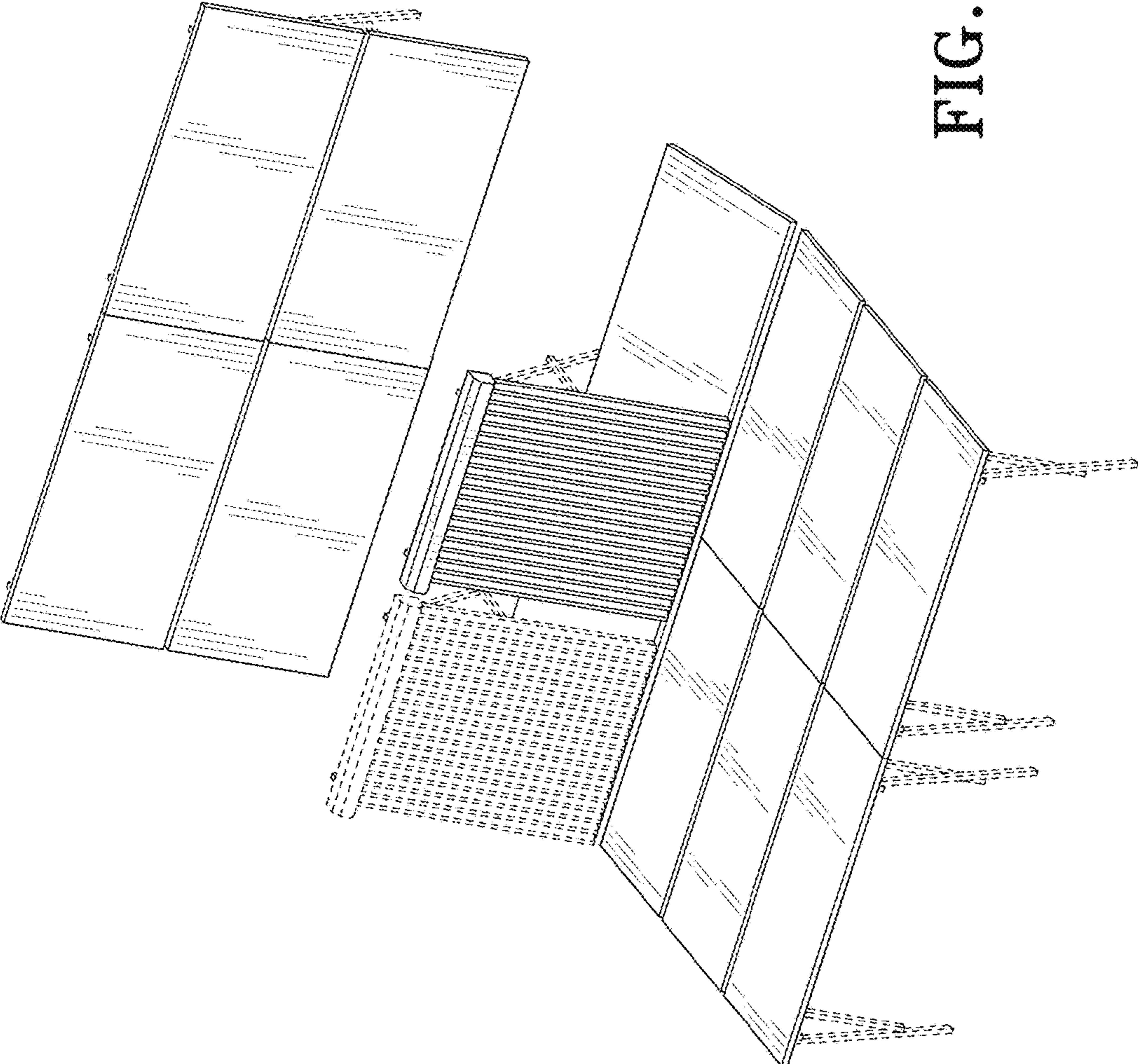

FIG. 2

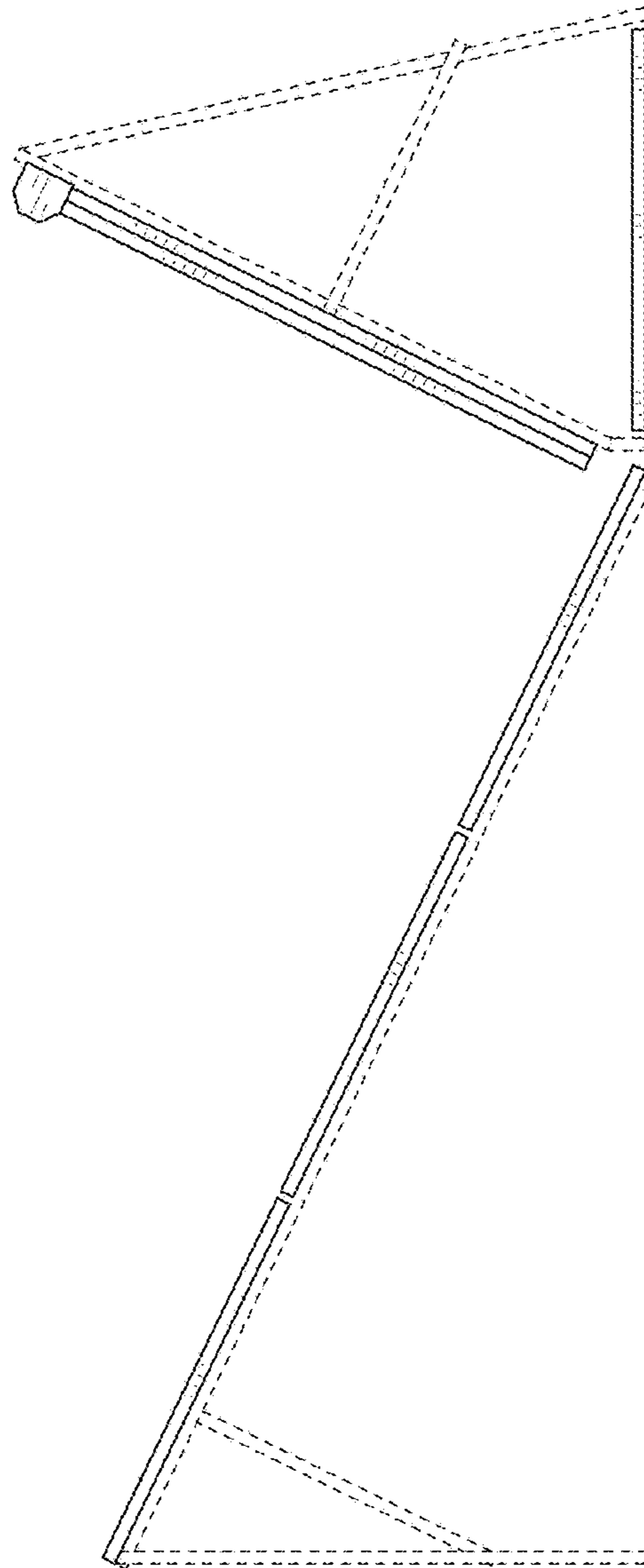
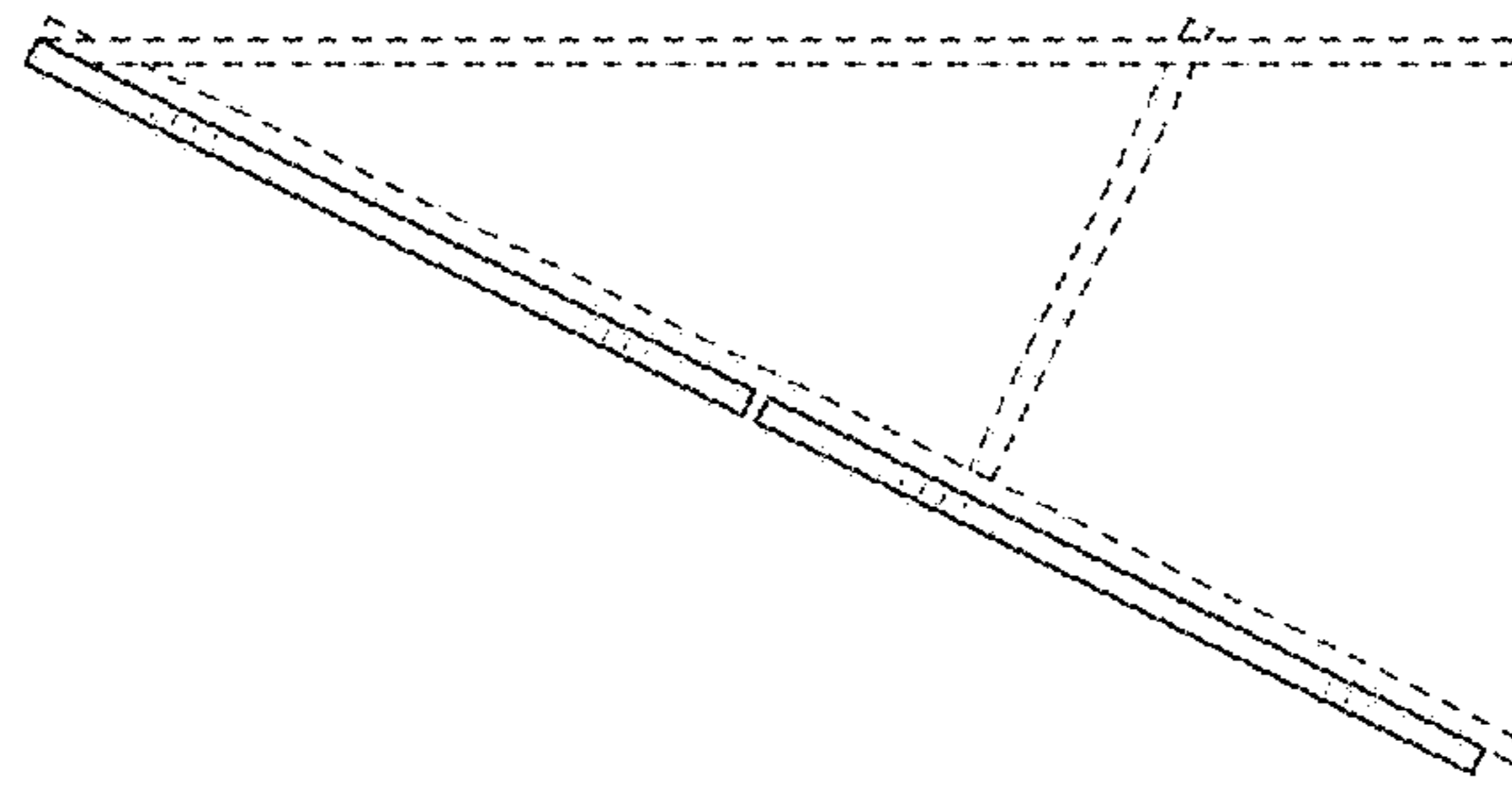

FIG. 3

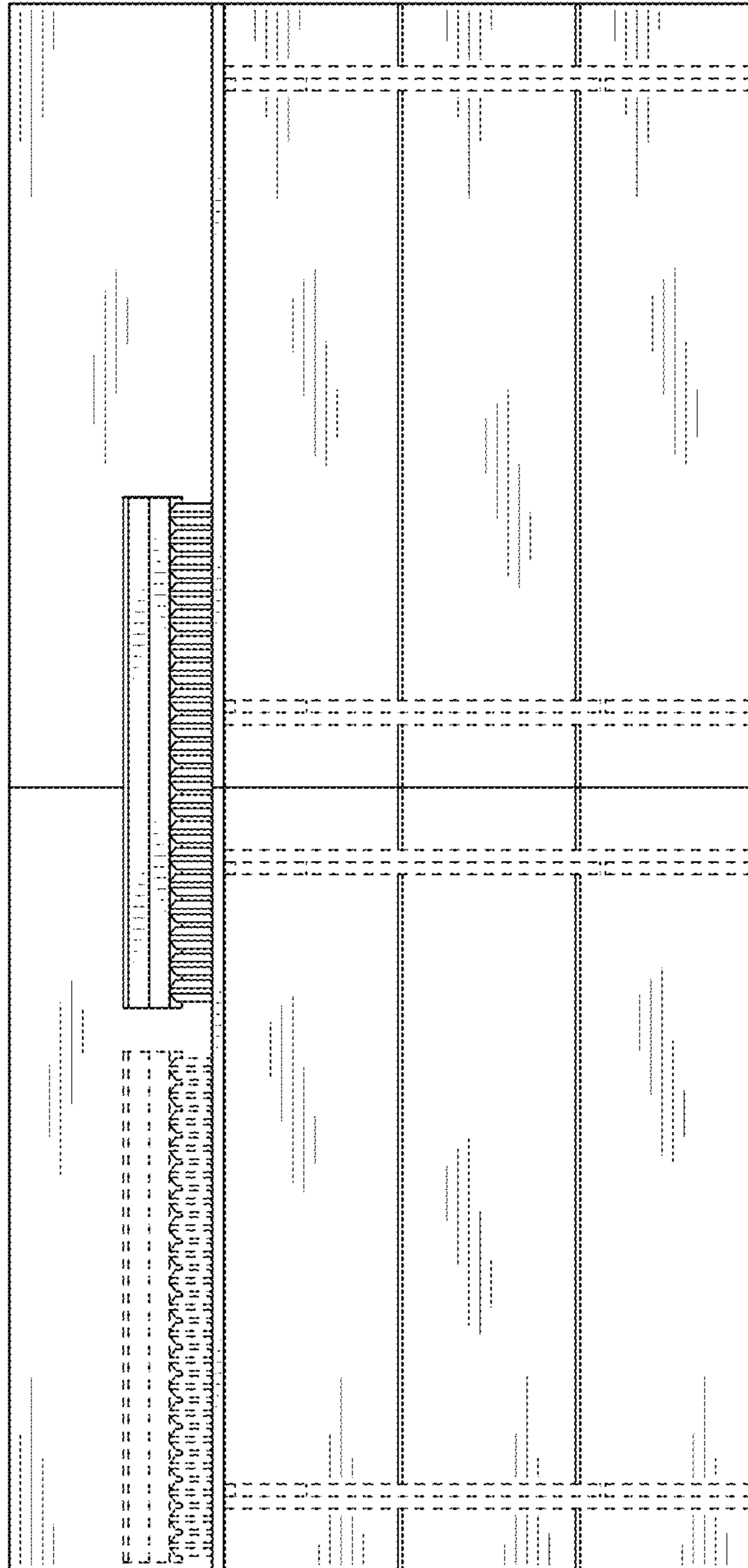

FIG. 4

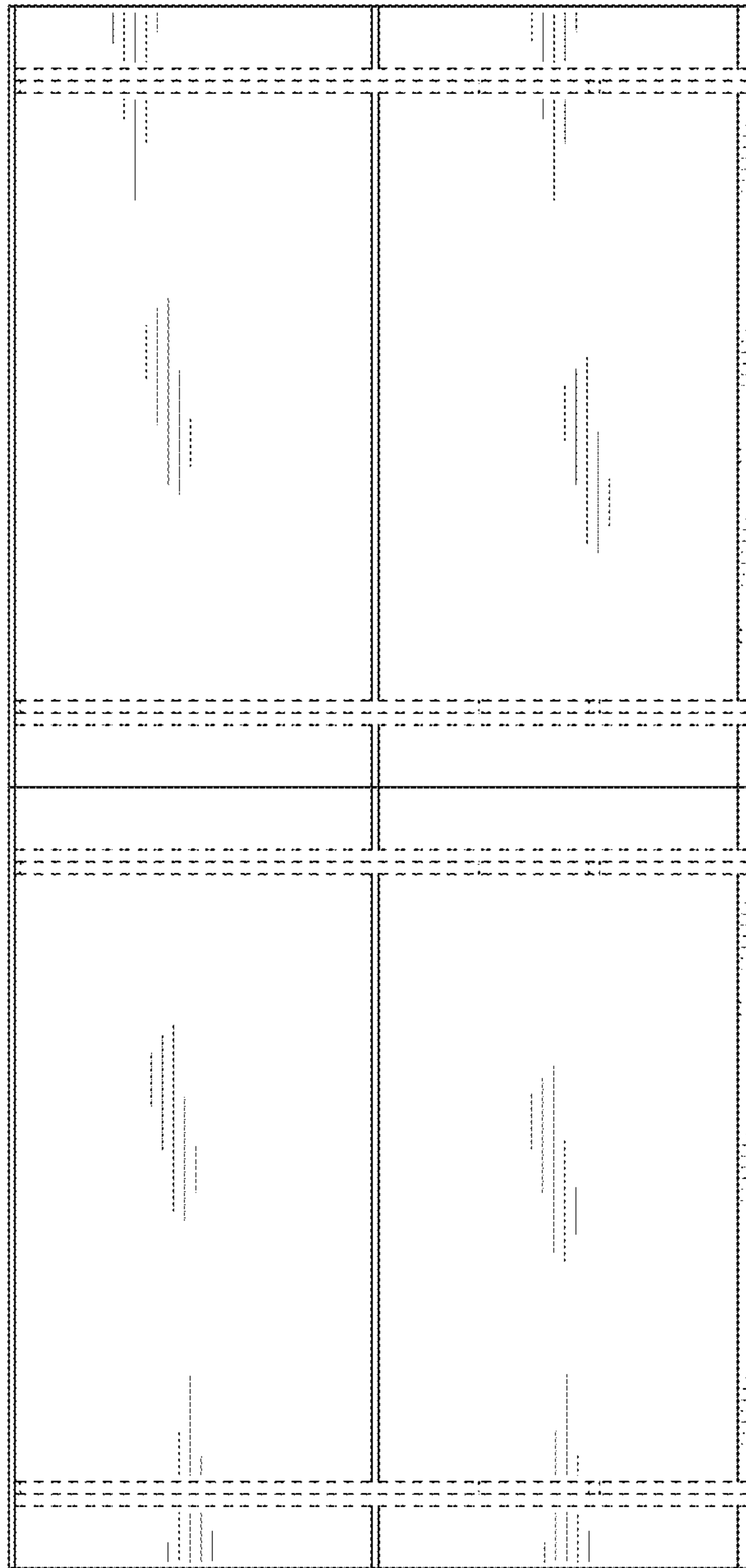

FIG. 5

FIG. 6

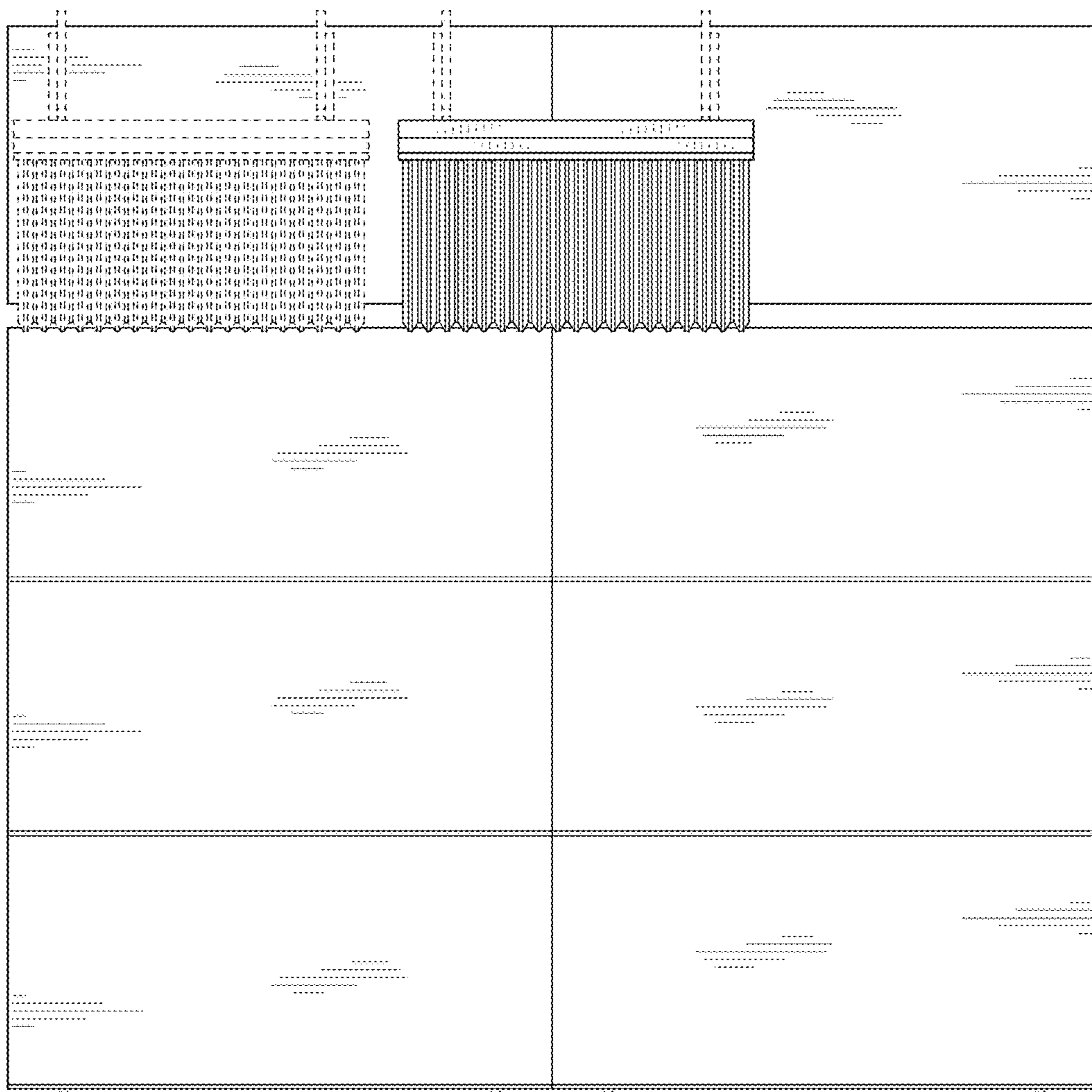
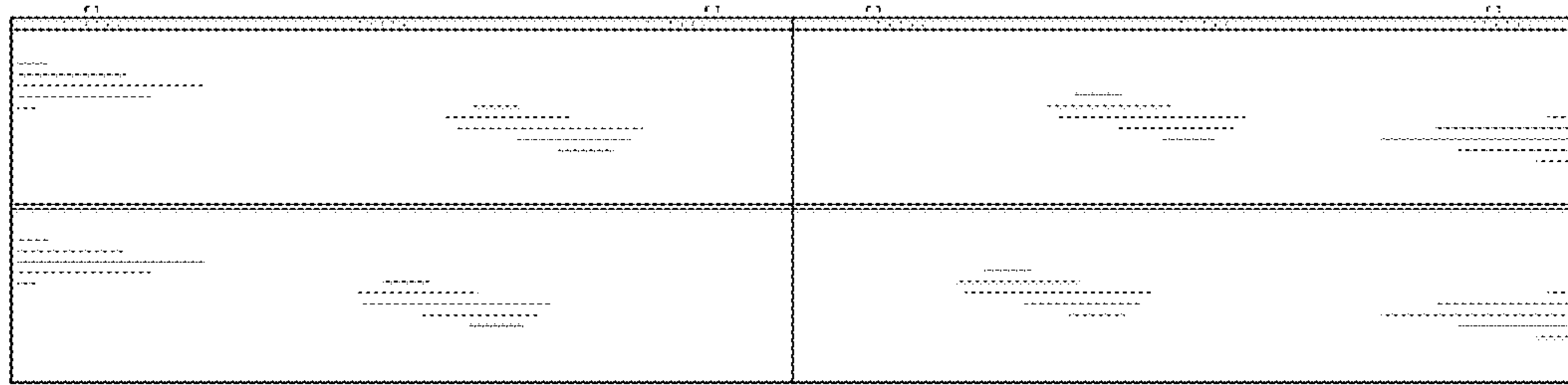

FIG. 7

