



US00D799325S

(12) **United States Design Patent** (10) **Patent No.:** **US D799,325 S**  
**Ozamiz** (45) **Date of Patent:** **\*\* Oct. 10, 2017**

(54) **BOTTLE**

(71) Applicant: **Berlin Packaging, LLC**, Chicago, IL (US)

(72) Inventor: **Katie Ozamiz**, Chicago, IL (US)

(73) Assignee: **Berlin Packaging, LLC**, Chicago, IL (US)

(\*\*) Term: **15 Years**

(21) Appl. No.: **29/571,475**

(22) Filed: **Jul. 19, 2016**

(51) **LOC (10) Cl.** ..... **09-01**

(52) **U.S. Cl.**  
USPC ..... **D9/523; D9/543; D9/563; D9/575**

(58) **Field of Classification Search**  
USPC ..... **D9/651, 658, 523-524, 528, 530-535, D9/548, 549-550, 574, 575, 520, 522, D9/526, 527, 553, 555, 556, 557, D9/563-570, 742, 516, 719, 536, 543; 215/381-385, 10; 220/660, 669, 679, 220/752; D23/211.1, 225; 206/510; D7/612**

CPC ..... **B65D 23/00; B65D 23/10; B65D 1/00; B65D 1/02; B65D 21/00; B65D 21/02; B65D 21/0201; B65D 21/0209; B65D 21/0233; B65D 21/0234; B65D 21/0237; B65D 1/10; B65D 1/40; B65D 1/42; B65D 11/04; B65D 2501/0081; B65D 2101/0053; B65D 1/0223; B65D 25/282; B65D 25/2811; B65D 25/2808; B65D 25/2805; B65D 21/0231**

See application file for complete search history.

(56) **References Cited**

U.S. PATENT DOCUMENTS

D336,434 S *	6/1993	Binder	.....	D9/528
D349,651 S *	8/1994	Saffer	.....	D9/528
D389,067 S *	1/1998	Lown	.....	D9/543
D409,090 S *	5/1999	Lai	.....	D9/523
D413,200 S *	8/1999	Baker	.....	D3/23
D495,603 S *	9/2004	Walsh	.....	D9/522
D530,617 S *	10/2006	Little	.....	B65D 1/14 D9/543
D547,662 S *	7/2007	Hankins	.....	D9/530
D558,577 S *	1/2008	Pettigrew	.....	D9/417
D585,748 S *	2/2009	Flanagan-Kent	.....	D9/516
D619,009 S *	7/2010	Heath	.....	D9/530
8,151,983 B2 *	4/2012	King, Jr.	.....	B65D 1/0246 206/216
D743,266 S *	11/2015	Rathbone	.....	D9/529

\* cited by examiner

*Primary Examiner* — Anhdao Doan

*Assistant Examiner* — Mary Malley

(74) *Attorney, Agent, or Firm* — Adam K. Sacharoff; Much Shelist, PC

(57) **CLAIM**

The ornamental design for a bottle, as shown and described.

**DESCRIPTION**

FIG. 1 is a top-rear side perspective view showing a bottle; FIG. 2 is a front side view of FIG. 1; FIG. 3 is a rear side view of FIG. 1; FIG. 4 is a right side view of FIG. 1; FIG. 5 is a left side view of FIG. 1; FIG. 6 is a top side view of FIG. 1; FIG. 7 is a bottom side view of FIG. 1; and, FIG. 8 is a bottom-front side perspective view of FIG. 1. The broken lines show portions of the bottle that form no part of the claimed design.

**1 Claim, 8 Drawing Sheets**

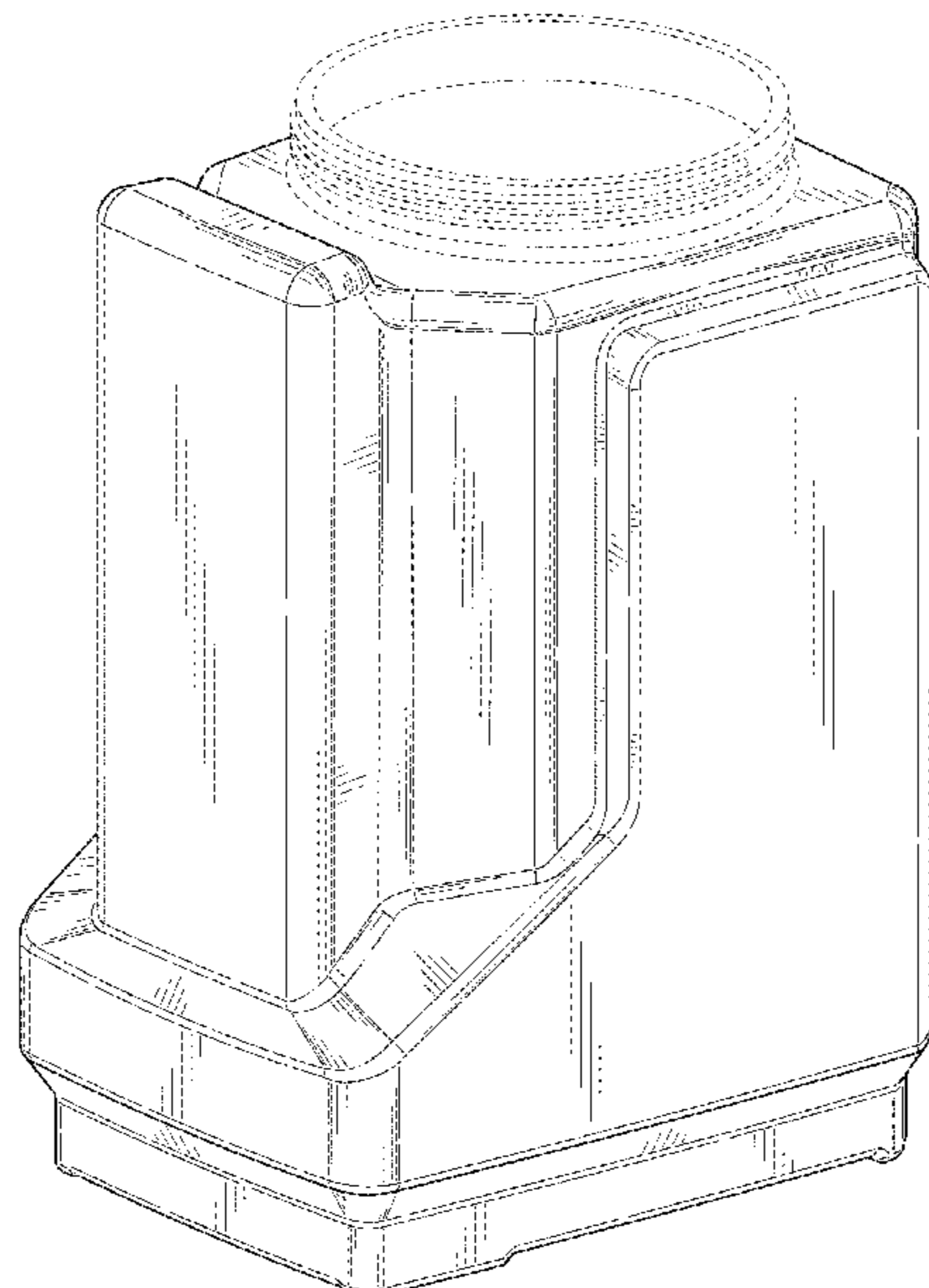

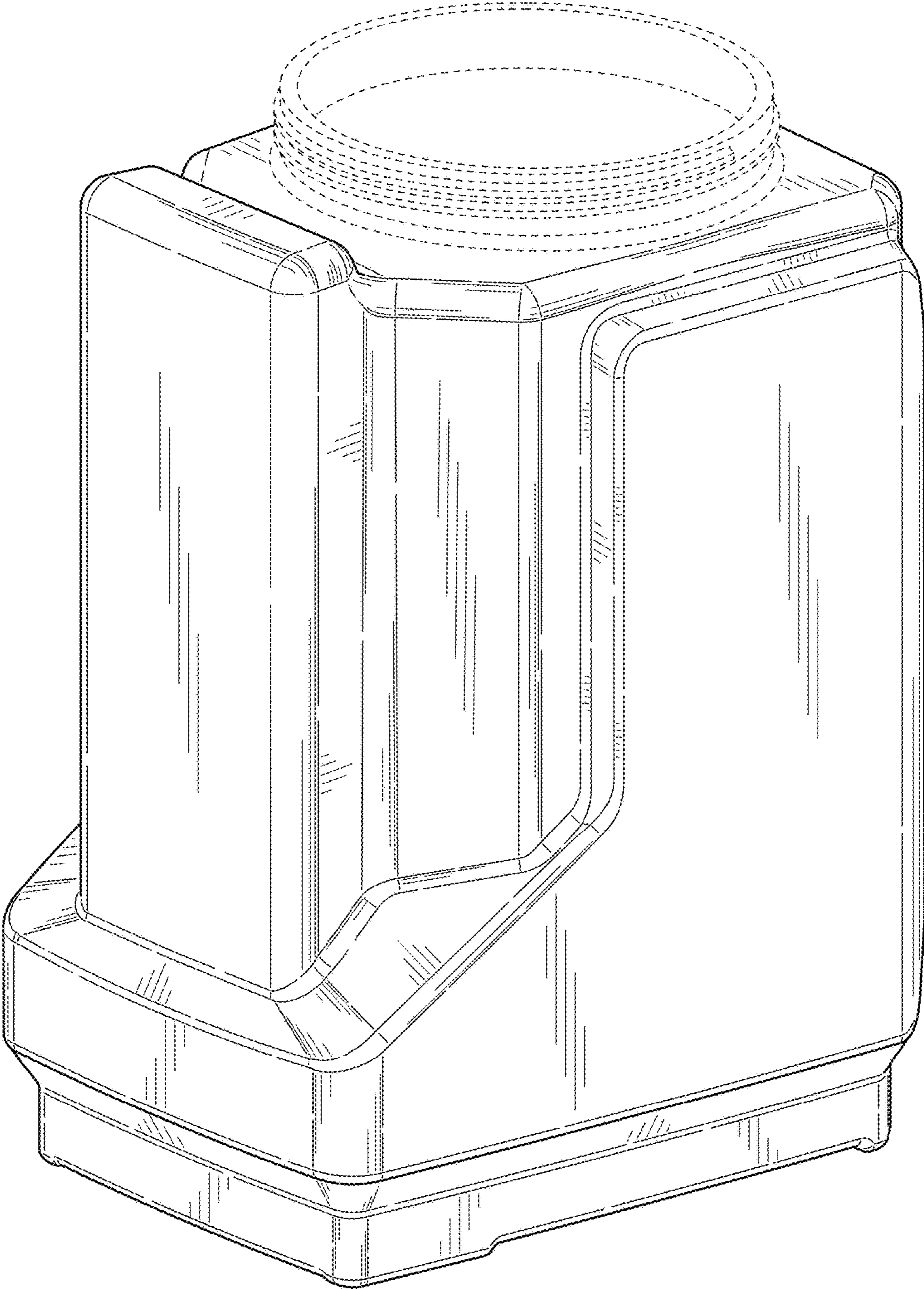

FIG. 1

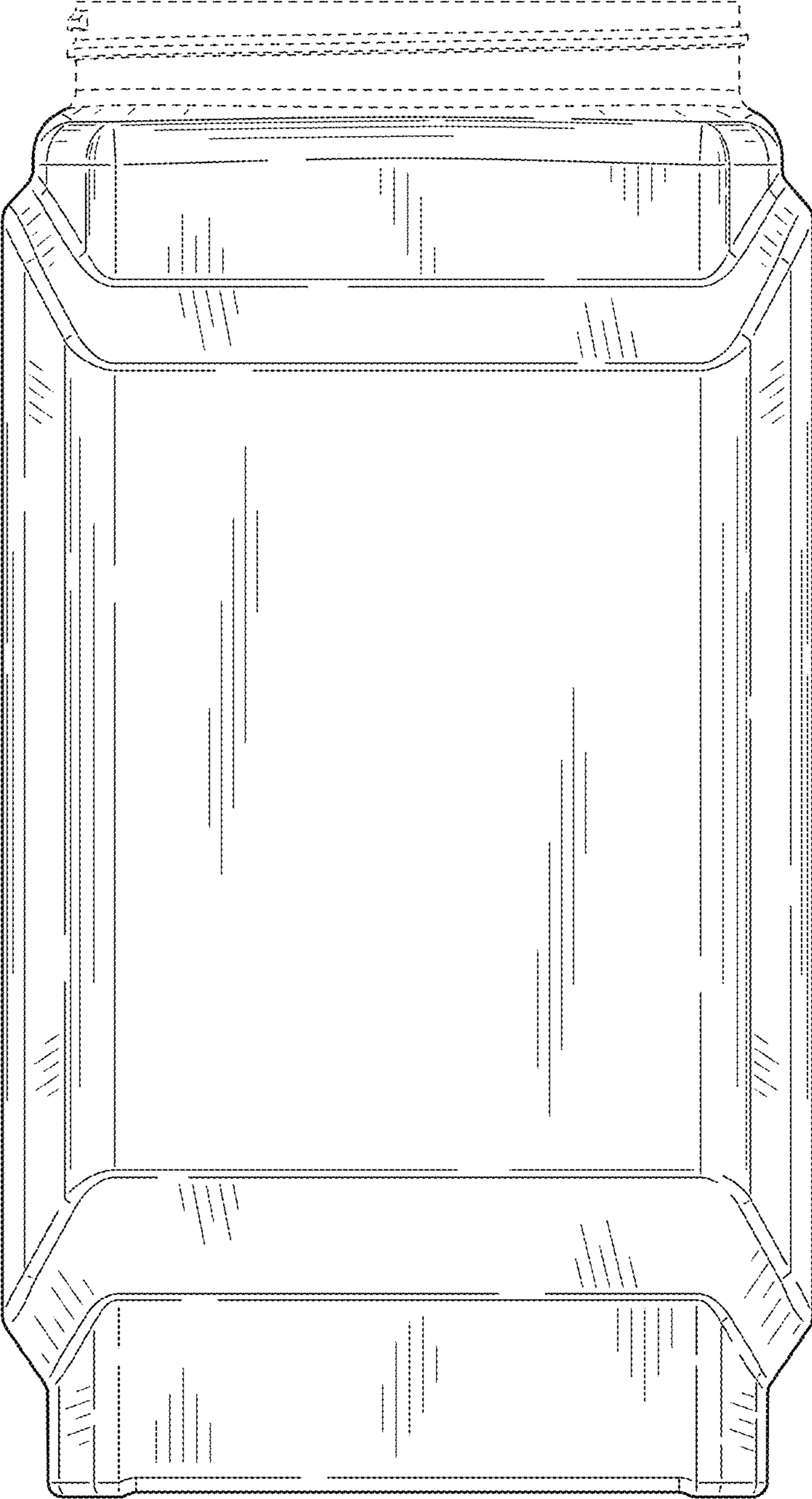

FIG. 2



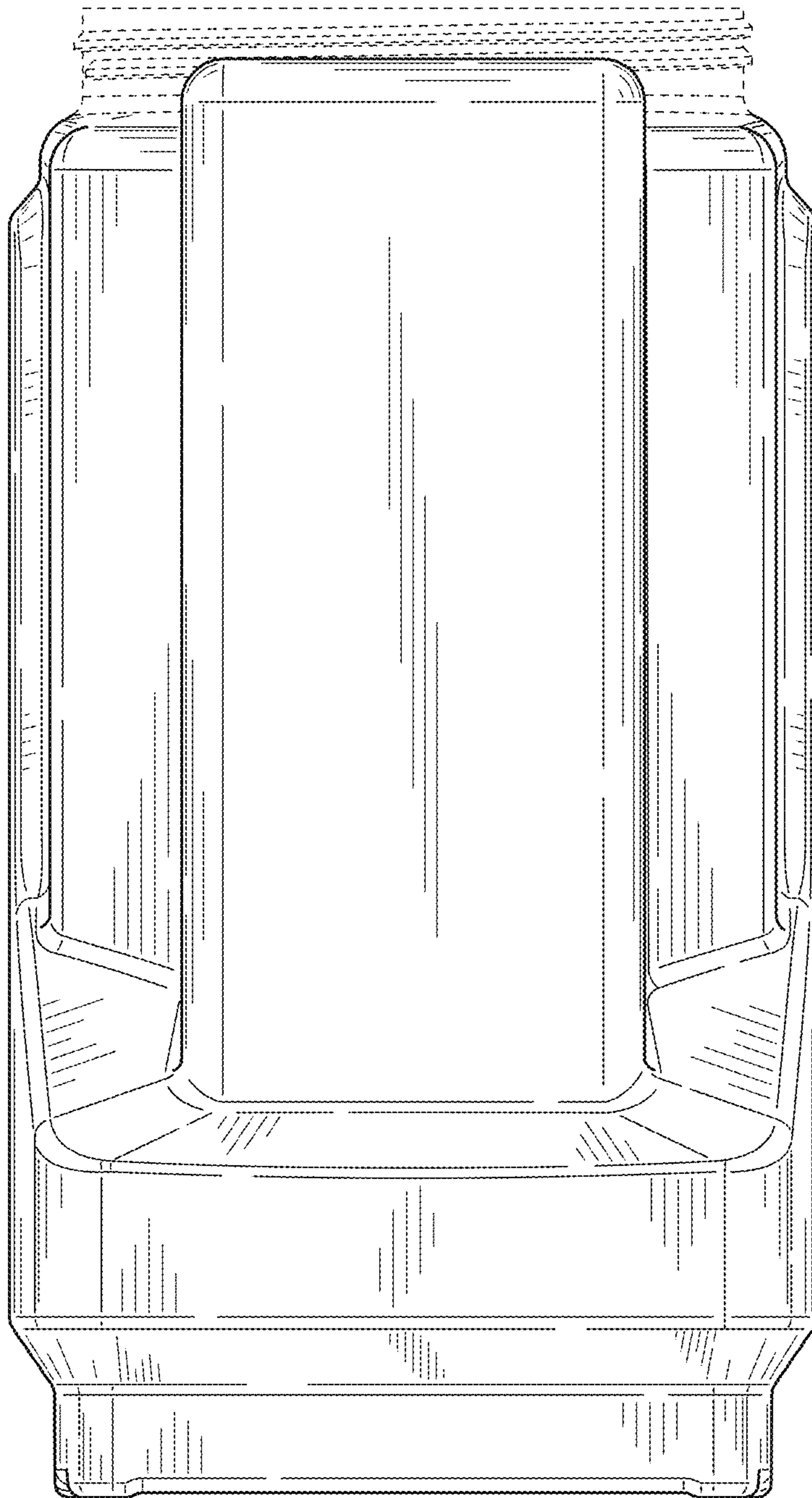

FIG. 3

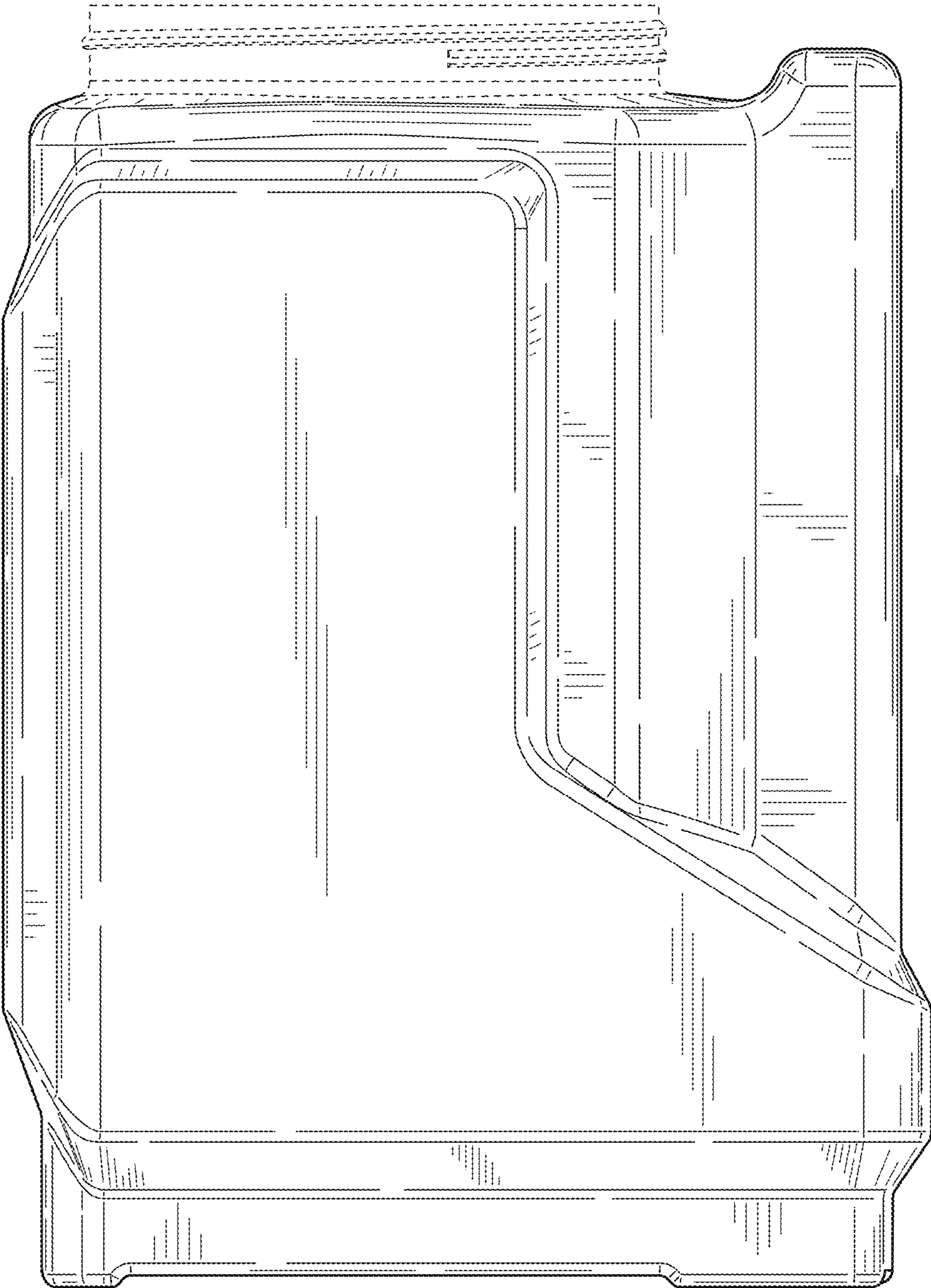

FIG. 4

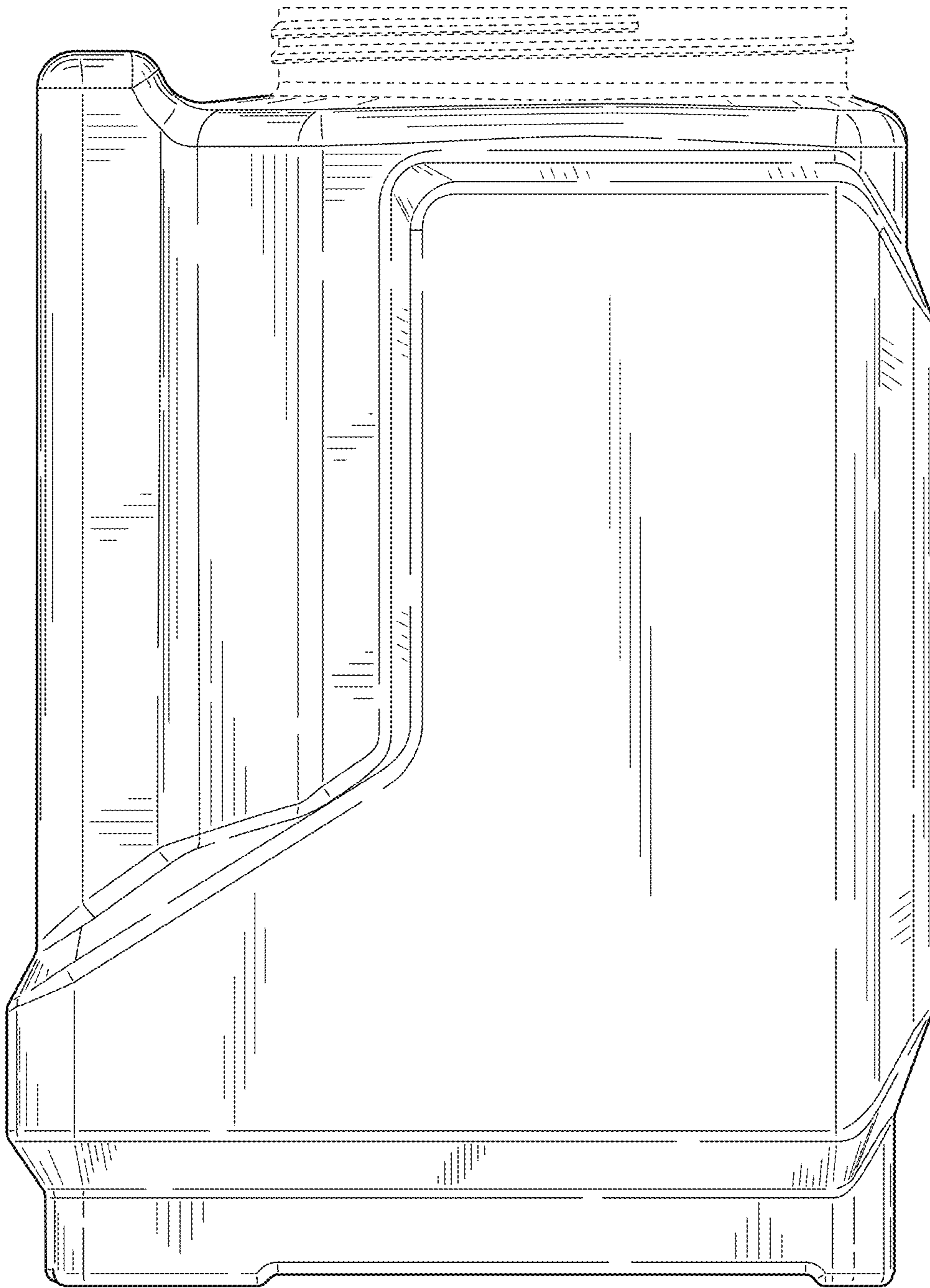

FIG. 5

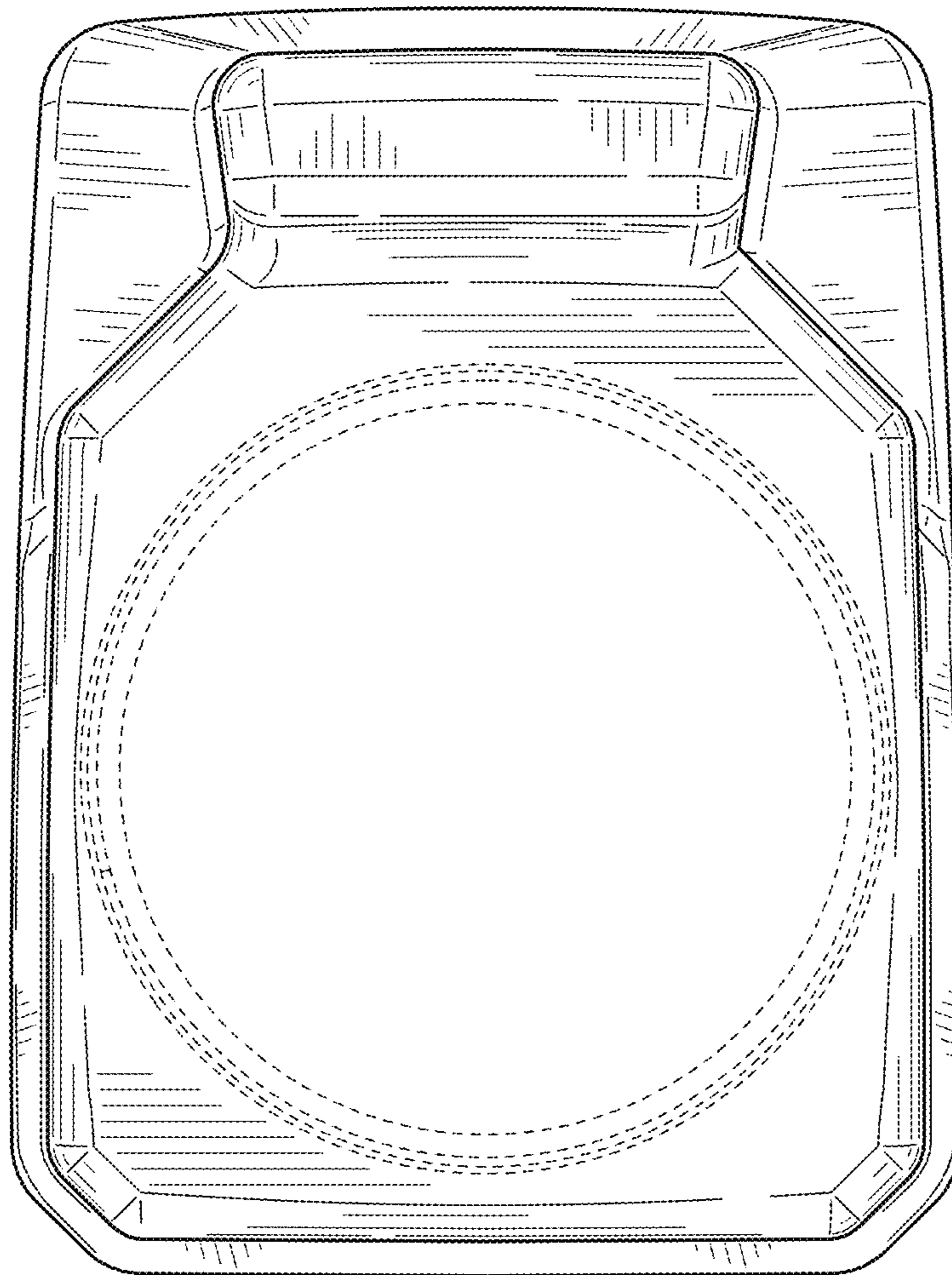

FIG. 6



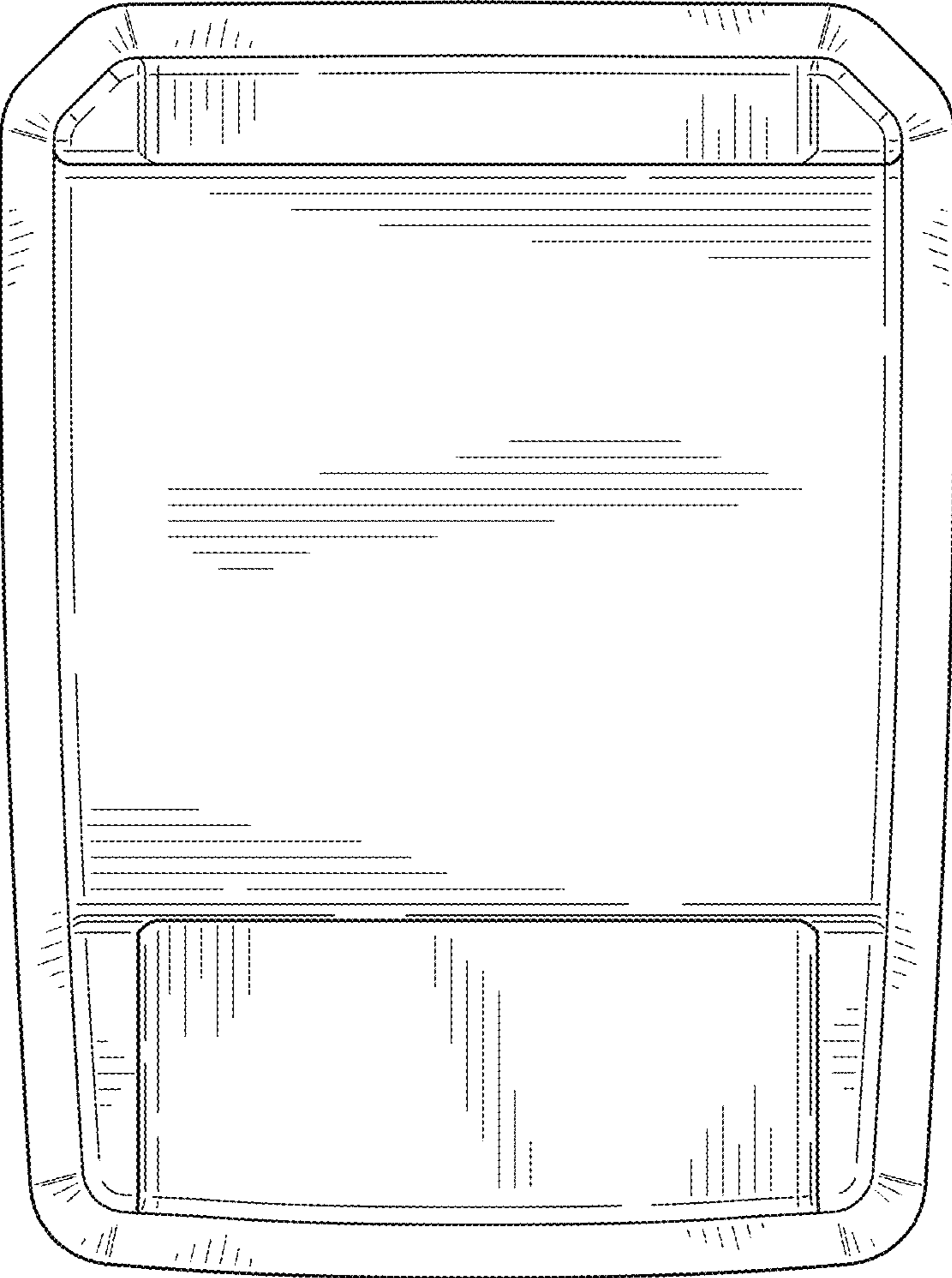

FIG. 7



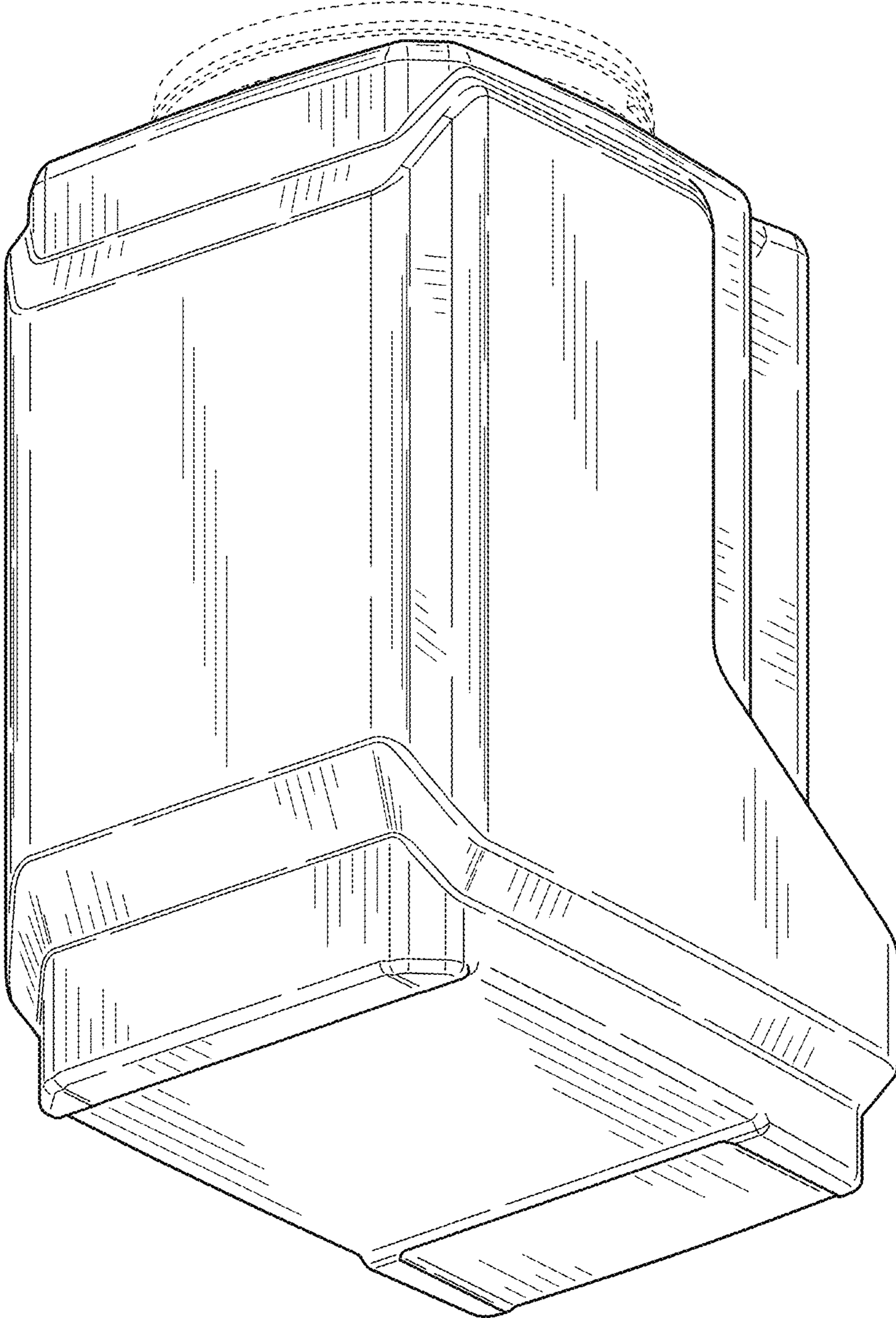

FIG. 8