



US00D799302S

(12) **United States Design Patent**
Bast et al.

(10) **Patent No.:** **US D799,302 S**
(45) **Date of Patent:** **** Oct. 10, 2017**

- (54) **TOOL HANDLE**
- (71) Applicant: **Gauthier Biomedical, Inc.**, Grafton, WI (US)
- (72) Inventors: **Robert Bast**, Sheboygan Falls, WI (US); **Austin R. S. Braganza**, Milwaukee, WI (US); **Robert F. Miller**, Grafton, WI (US)
- (73) Assignee: **Gauthier Biomedical, Inc.**, Grafton, WI (US)
- (**) Term: **14 Years**
- (21) Appl. No.: **29/500,392**
- (22) Filed: **Aug. 25, 2014**
- (51) **LOC (10) Cl.** **08-05**
- (52) **U.S. Cl.**
USPC **D8/107; D24/133**
- (58) **Field of Classification Search**
USPC D8/14, 51, 107, 300, 306, 307, 308; D24/133
CPC A47L 1/00; A47L 1/16; B25G 3/18; B25G 3/30
See application file for complete search history.

D613,144 S *	4/2010	Lin	D8/107
7,942,253 B2 *	5/2011	Schneeman	B25B 15/04
				192/43.2
D648,433 S *	11/2011	Bast	D24/133
D649,423 S *	11/2011	Robinson	D8/83
D663,025 S *	7/2012	Bast	D24/133
D673,832 S *	1/2013	Molina	D8/83
D687,690 S *	8/2013	Chen	D8/105
D734,115 S *	7/2015	Robinson	D8/83
D758,813 S *	6/2016	Christopher	D8/21
2006/0179981 A1 *	8/2006	Cutler	B25B 15/02
				81/475

* cited by examiner

Primary Examiner — Phillip S Hyder

(74) *Attorney, Agent, or Firm* — Boyle Fredrickson, S.C.

(57) **CLAIM**

The ornamental design for a tool handle, as shown and described.

DESCRIPTION

FIG. 1 is an isometric view of a first embodiment of a tool handle incorporating our new design, wherein the dot-dash lines define the boundaries of the claimed design. The dash-dash lines depict portions of the handle that are not considered part of the claimed design.

FIG. 2 is a front elevation view thereof;

FIG. 3 is a rear elevation view thereof;

FIG. 4 is a right side elevation view thereof;

FIG. 5 is a left side elevation view thereof;

FIG. 6 is a top plan view thereof; and,

FIG. 7 is a bottom plan view thereof.

1 Claim, 5 Drawing Sheets

(56) **References Cited**

U.S. PATENT DOCUMENTS

D365,239 S *	12/1995	Emery	D6/566
D517,634 S *	3/2006	Nunez	D21/789
D557,584 S *	12/2007	Gao	D8/107

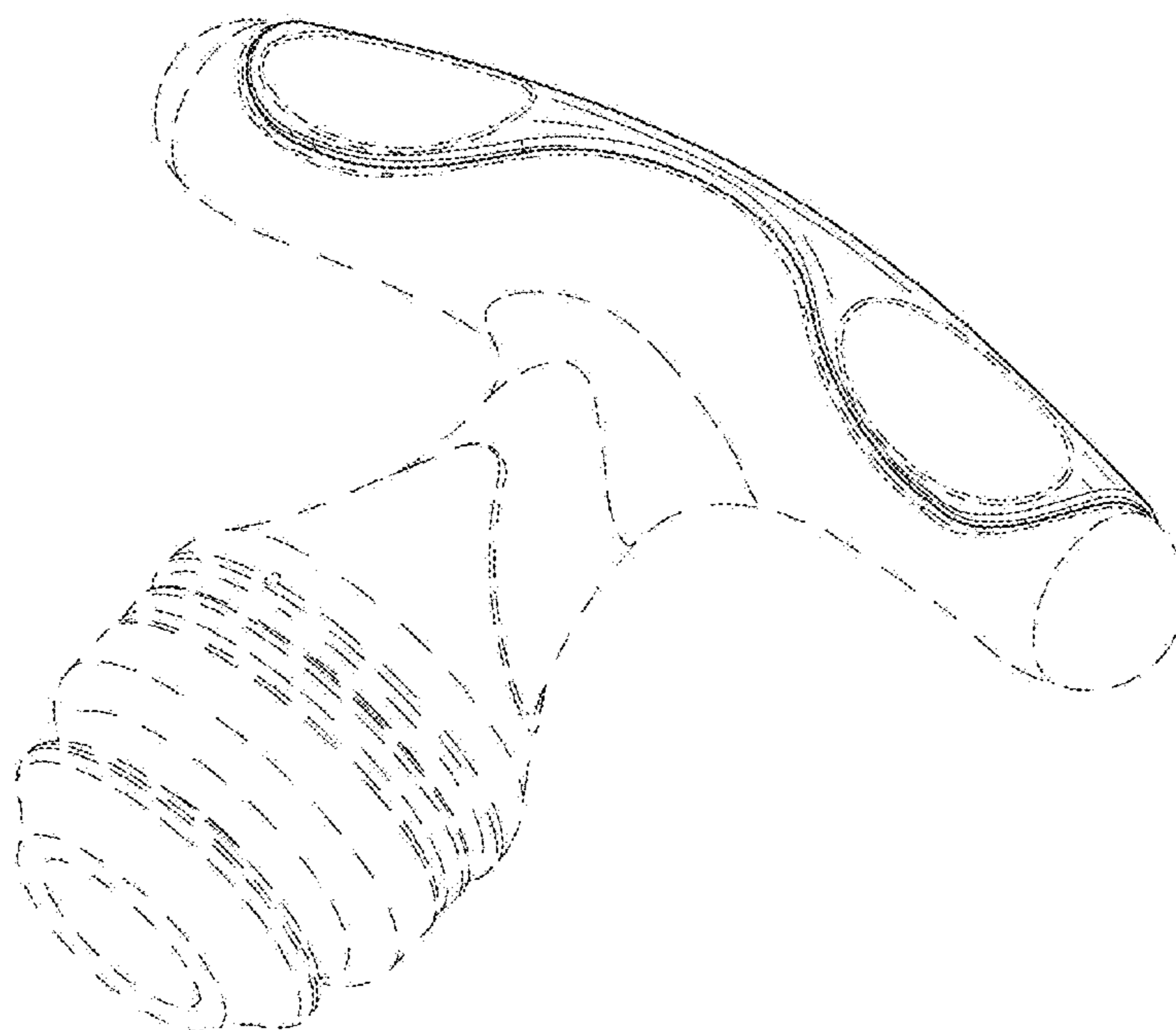

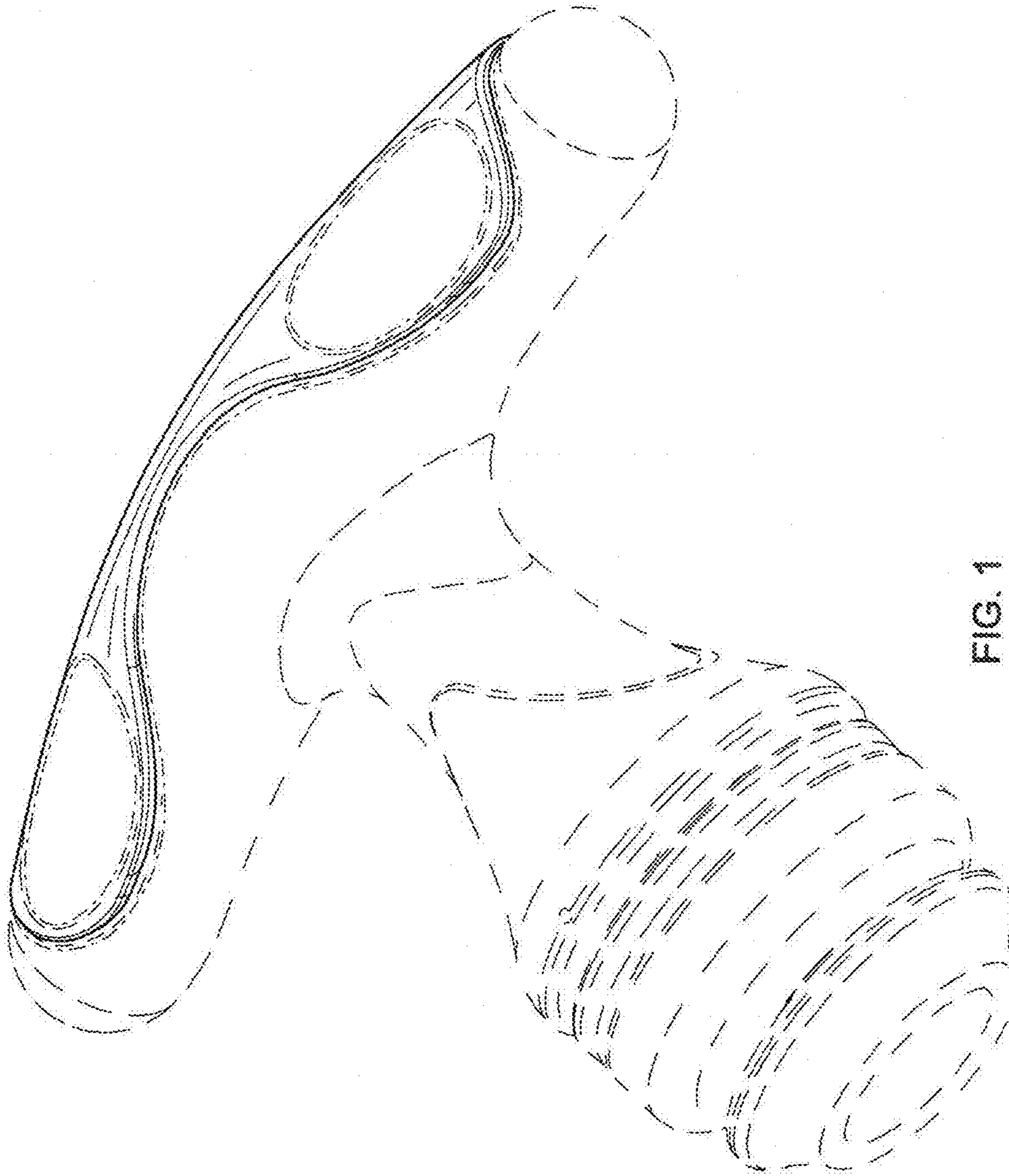

FIG. 1

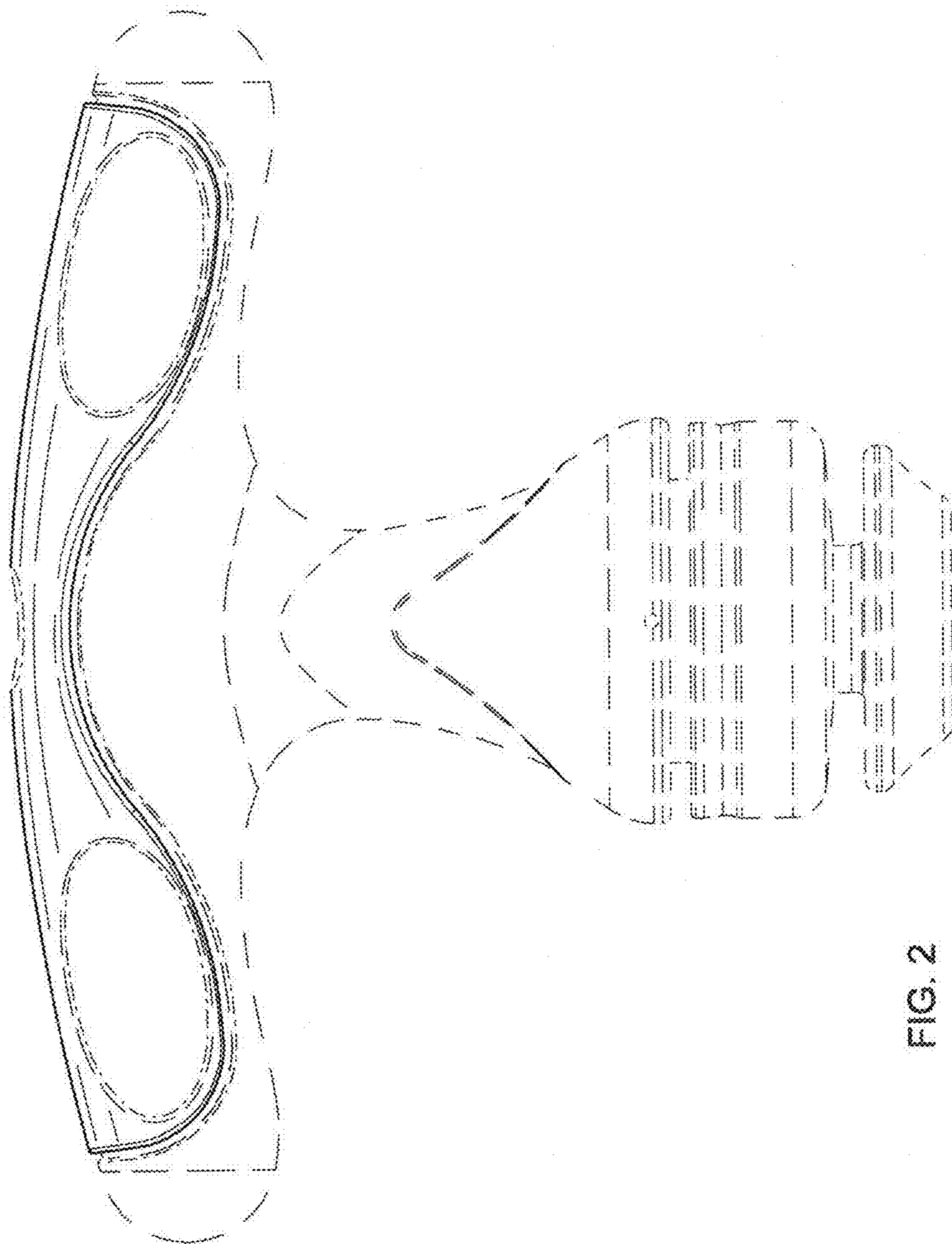

FIG. 2

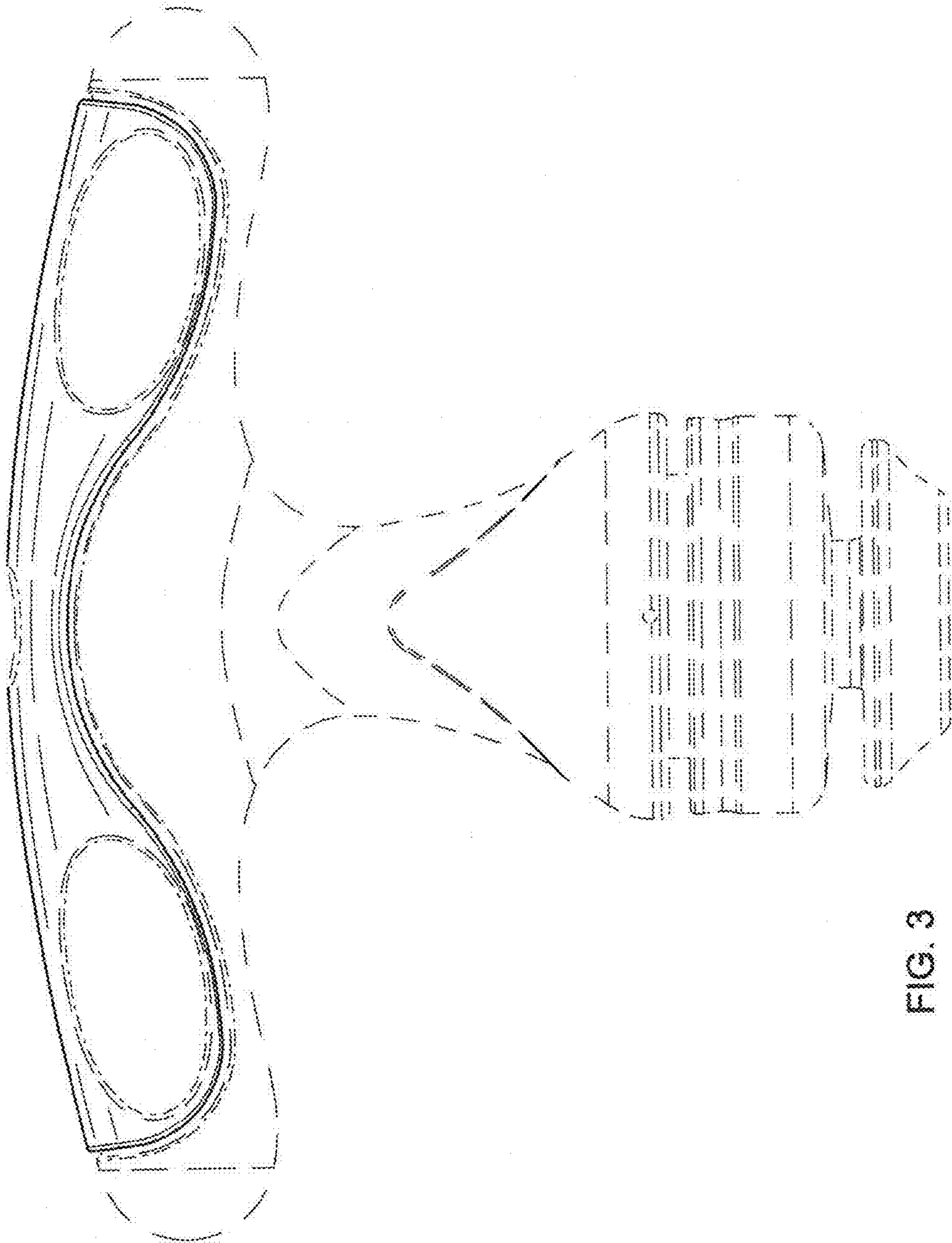

FIG. 3

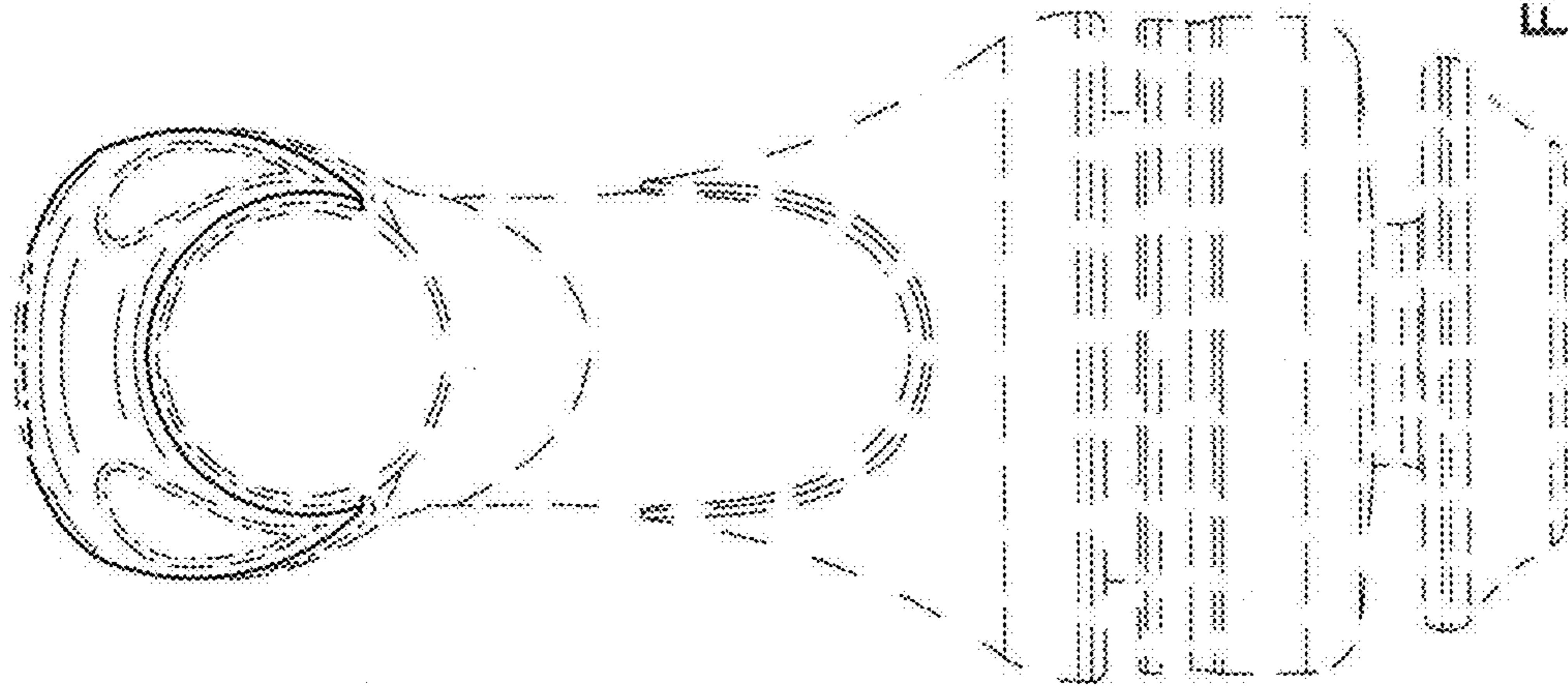

FIG. 5

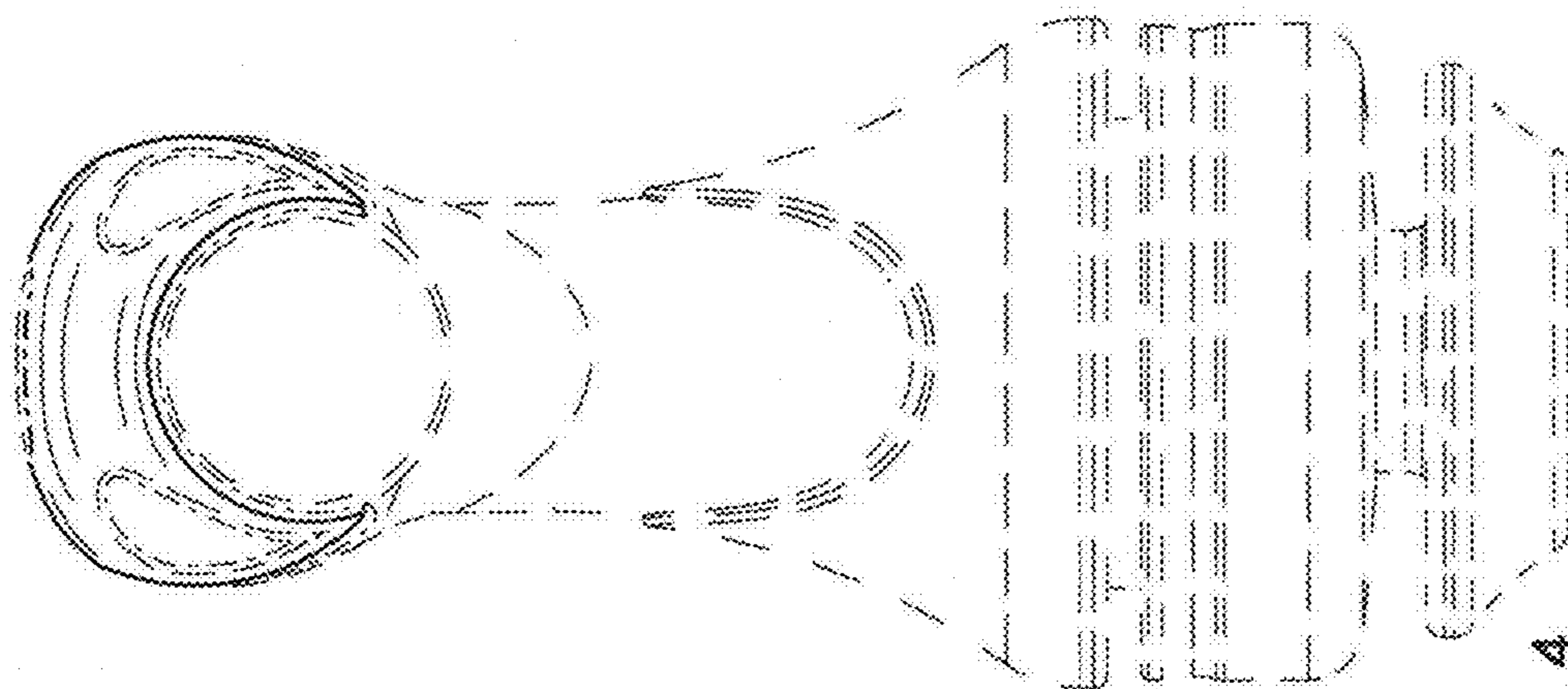

FIG. 4

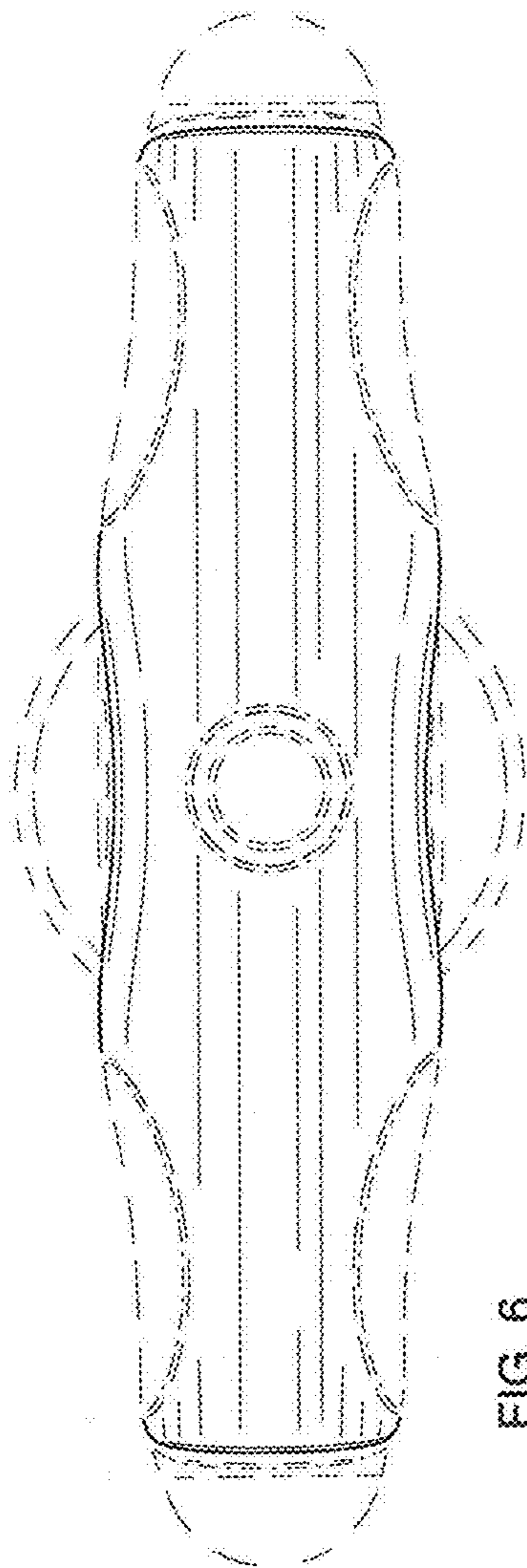

FIG. 6

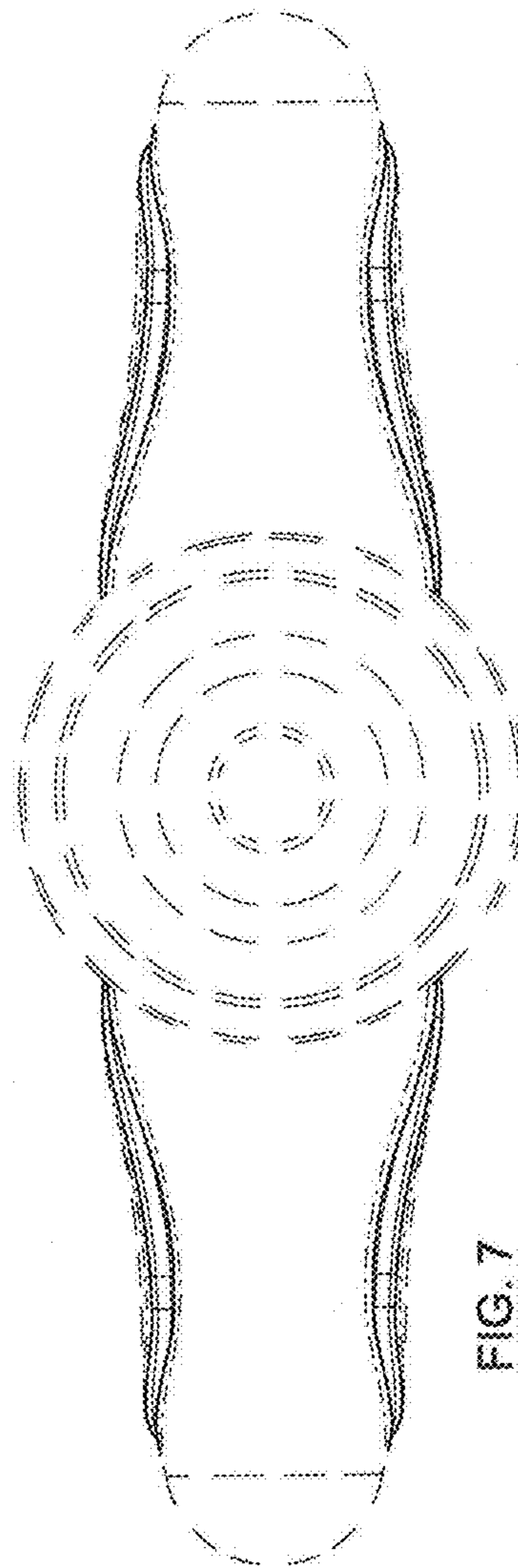

FIG. 7