



US00D799260S

(12) **United States Design Patent** (10) **Patent No.:** **US D799,260 S**  
**McDougall et al.** (45) **Date of Patent:** **\*\* Oct. 10, 2017**

(54) **COOKING WARE WITH HEART LOGO**  
(71) Applicant: **Brand Developers Limited**, Auckland (NZ)  
(72) Inventors: **Roy Steven McDougall**, Auckland (NZ); **Teng Onn Tan**, Auckland (NZ)  
(73) Assignee: **BRAND DEVELOPERS LIMITED**, Auckland (NZ)  
(\*\*) Term: **15 Years**  
(21) Appl. No.: **29/568,823**  
(22) Filed: **Jun. 21, 2016**

D545,612 S \* 7/2007 Wasserman ..... D7/354  
D555,418 S \* 11/2007 Cheng ..... D7/354  
D614,910 S \* 5/2010 Lion ..... D7/354  
D656,358 S \* 3/2012 Cloutier ..... D7/354  
D682,012 S \* 5/2013 Lin ..... D7/354  
D682,013 S \* 5/2013 Huang ..... D7/354  
D696,060 S \* 12/2013 Schleinzer ..... D7/354  
D708,472 S \* 7/2014 Landers ..... D7/354  
D734,090 S \* 7/2015 Bourbeau ..... D7/354  
D734,091 S \* 7/2015 Moon ..... D7/354  
D763,618 S \* 8/2016 Feng ..... D7/354  
D766,032 S \* 9/2016 Moulin ..... D7/354  
D777,506 S \* 1/2017 Mirchandani ..... D7/354  
2011/0073602 A1 \* 3/2011 Musil ..... A47J 27/002  
220/573.2  
2013/0037553 A1 \* 2/2013 Bourbeau ..... A47J 37/10  
220/573.1  
2015/0001226 A1 \* 1/2015 Groll ..... B23K 20/002  
220/573.1

(30) **Foreign Application Priority Data**  
Dec. 22, 2015 (AU) ..... 16982/2015  
(51) **LOC (10) Cl.** ..... **07-02**  
(52) **U.S. Cl.**  
USPC ..... **D7/361; D7/354**  
(58) **Field of Classification Search**  
USPC ..... D7/323, 354, 360-361, 363, 367,  
D7/393-396, 402, 409  
CPC ..... A47J 36/025; A47J 36/02; A47J 36/06;  
A47J 36/12; A47J 37/00; A47J 37/10;  
A47J 27/21; A47J 27/58  
See application file for complete search history.

(56) **References Cited**  
U.S. PATENT DOCUMENTS  
2,952,225 A \* 9/1960 Ellison ..... A23G 3/28  
101/127  
D372,834 S \* 8/1996 Wagner ..... D7/354  
5,829,342 A \* 11/1998 Lee ..... A47J 36/06  
16/425  
D431,151 S \* 9/2000 Brunianyn ..... D7/354  
D545,115 S \* 6/2007 Wasserman ..... D7/354  
D545,116 S \* 6/2007 Wasserman ..... D7/354

(Continued)

*Primary Examiner* — Elizabeth Albert  
*Assistant Examiner* — Mehri Bajoul  
(74) *Attorney, Agent, or Firm* — Jonathan Kidney;  
TechLaw LLP

(57) **CLAIM**  
The ornamental design for a cooking ware with heart logo, as shown and described.

**DESCRIPTION**

FIG. 1 is a top perspective view of a cooking ware with heart logo showing my new design;  
FIG. 2 is a top view thereof;  
FIG. 3 is a bottom view thereof;  
FIG. 4 is a right side view thereof;  
FIG. 5 is a left side view thereof;  
FIG. 6 is a front side view thereof; and,  
FIG. 7 is a rear side view thereof;  
The broken lines shown represent unclaimed subject matter only and form no part of the claimed design.

**1 Claim, 7 Drawing Sheets**

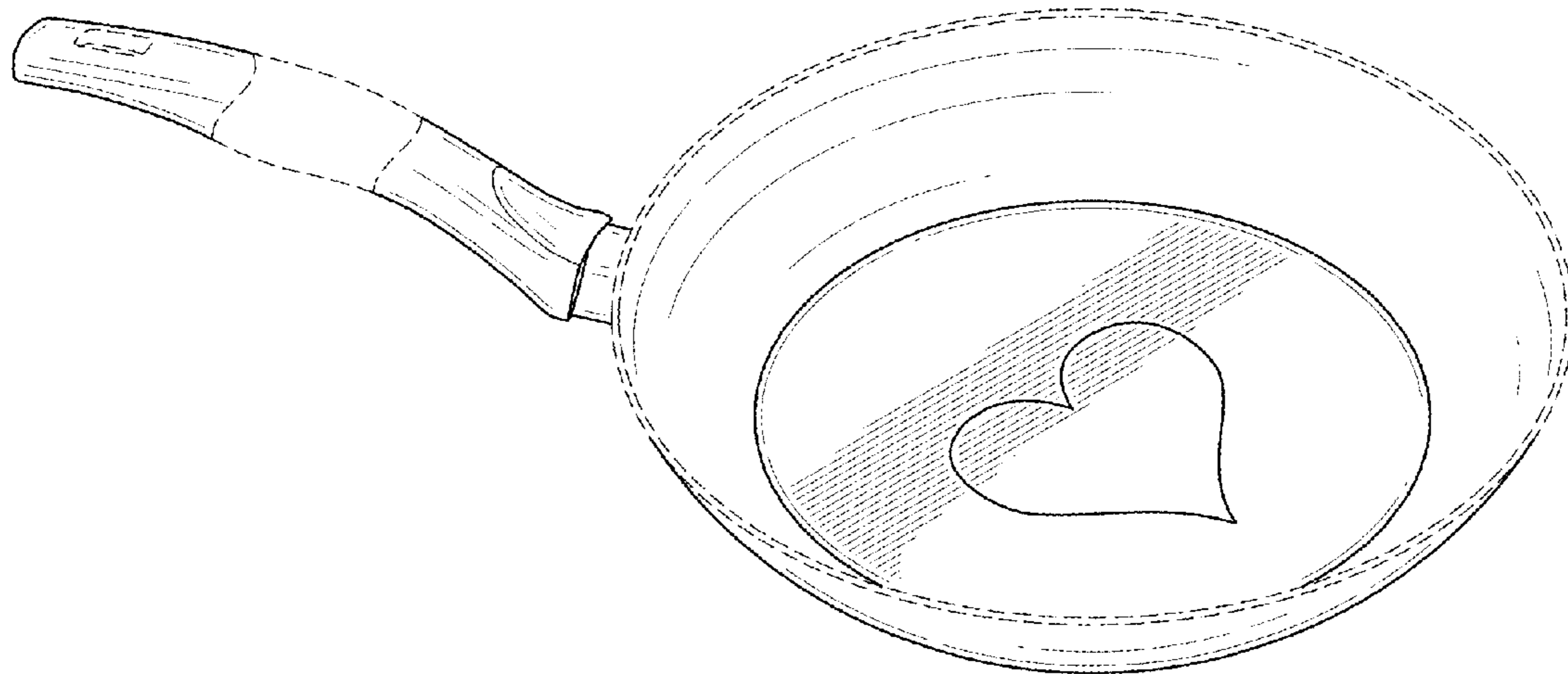

(56)

**References Cited**

U.S. PATENT DOCUMENTS

2015/0083711 A1\* 3/2015 Moon ..... A47J 27/002  
219/621  
2015/0342386 A1\* 12/2015 Lee ..... A47J 45/061  
220/573.1  
2016/0274076 A1\* 9/2016 Hofleitner ..... A47J 36/00

\* cited by examiner

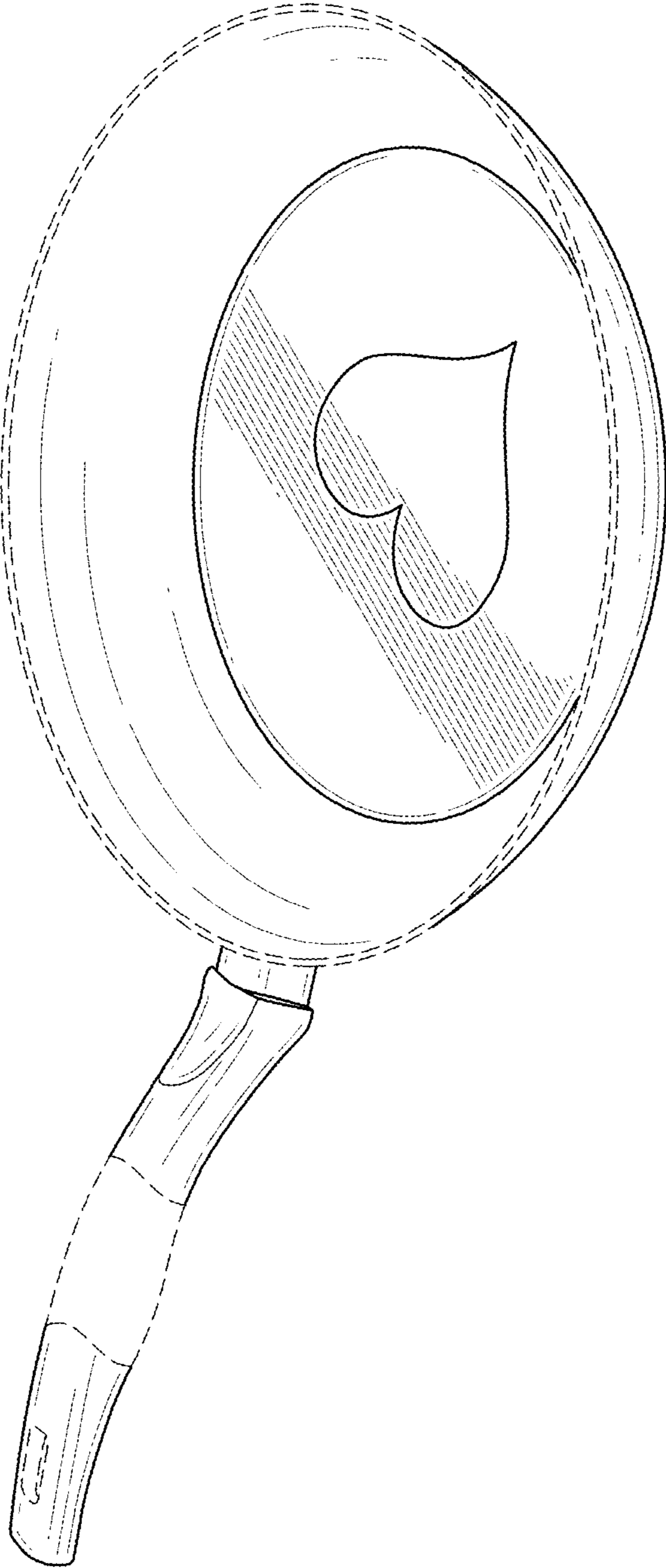

FIG.1

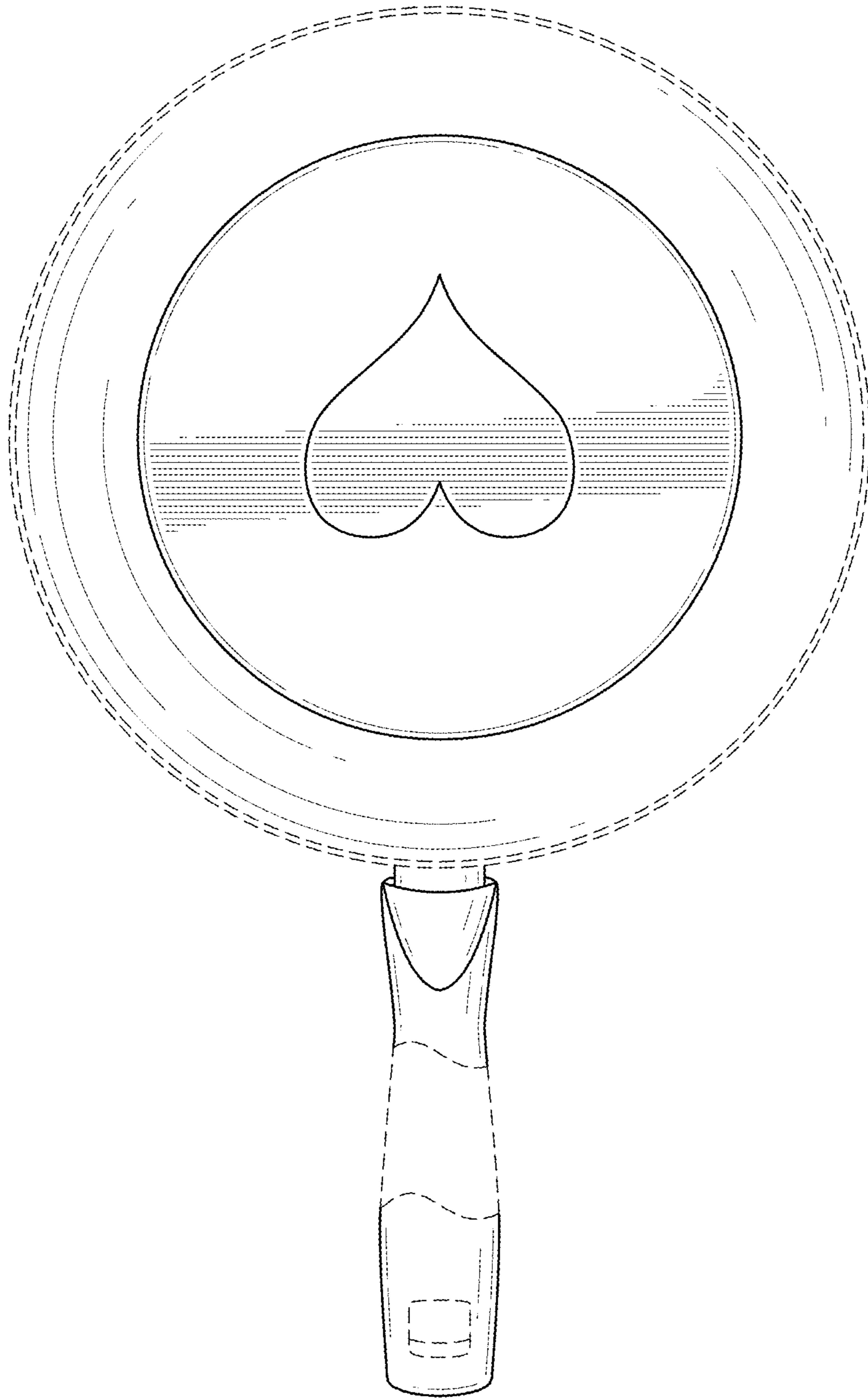

FIG.2

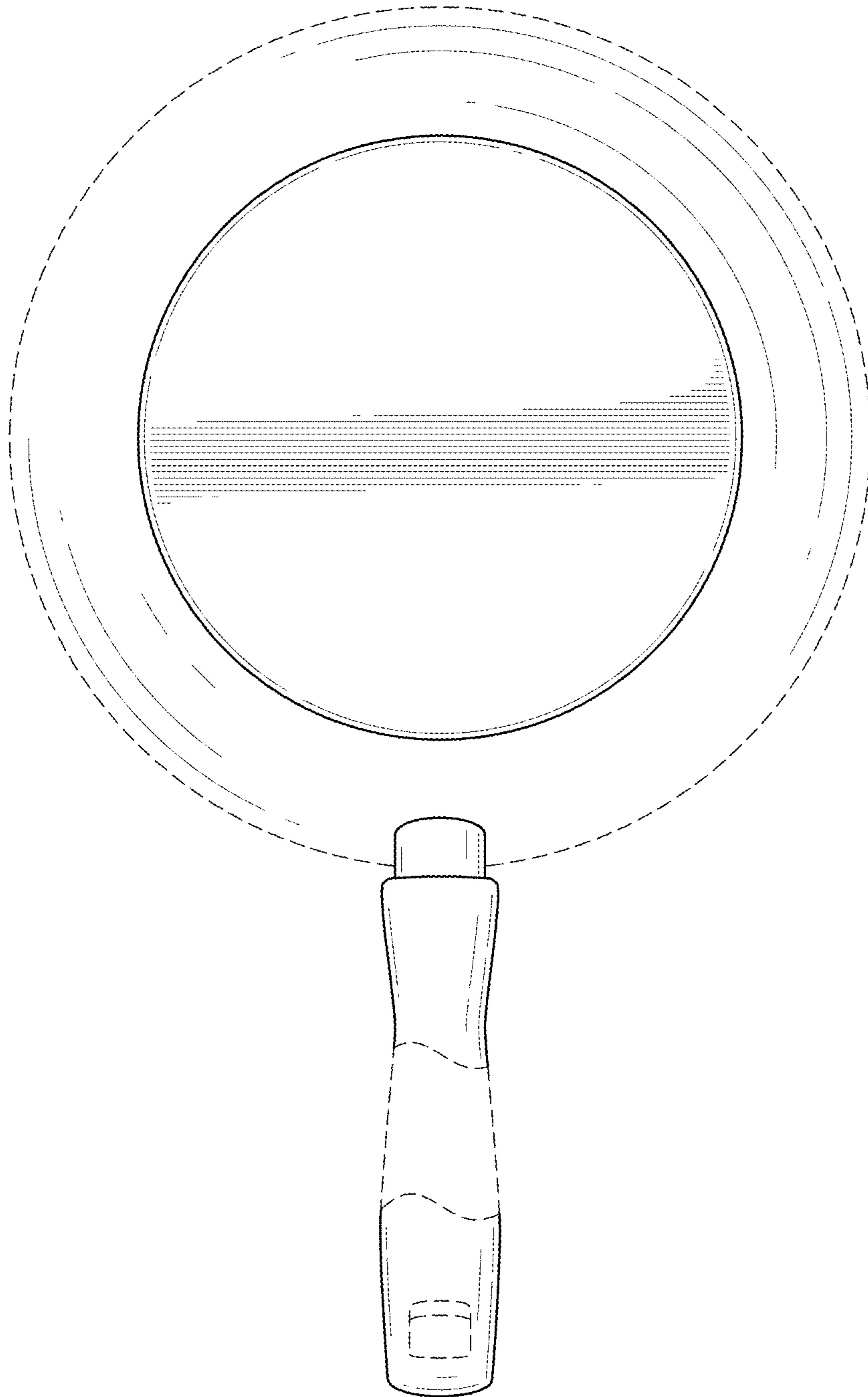

FIG.3

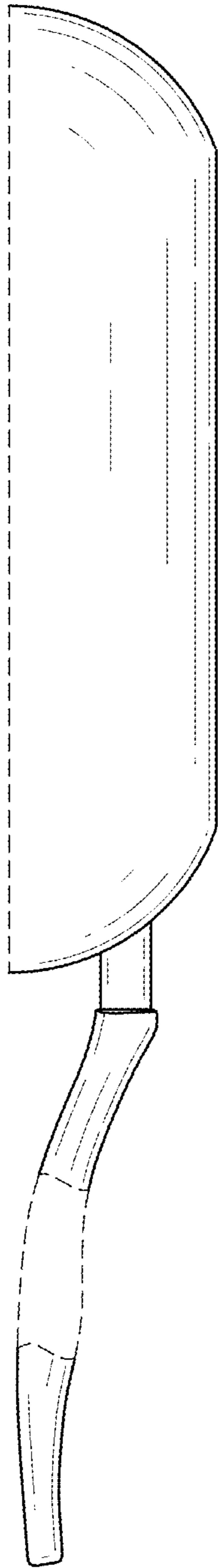

FIG. 4

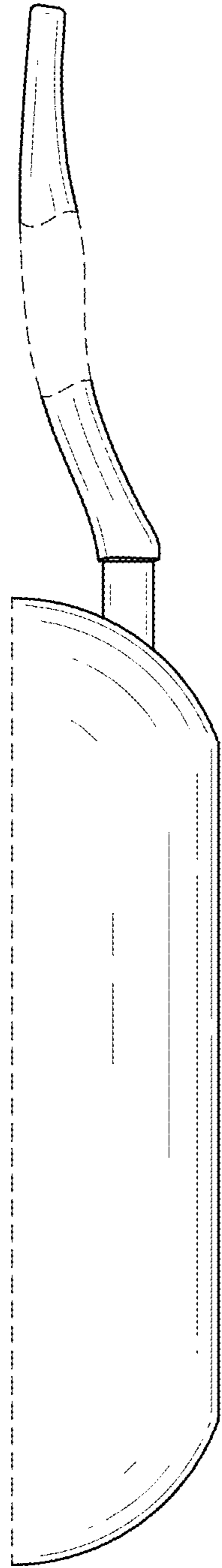

FIG. 5

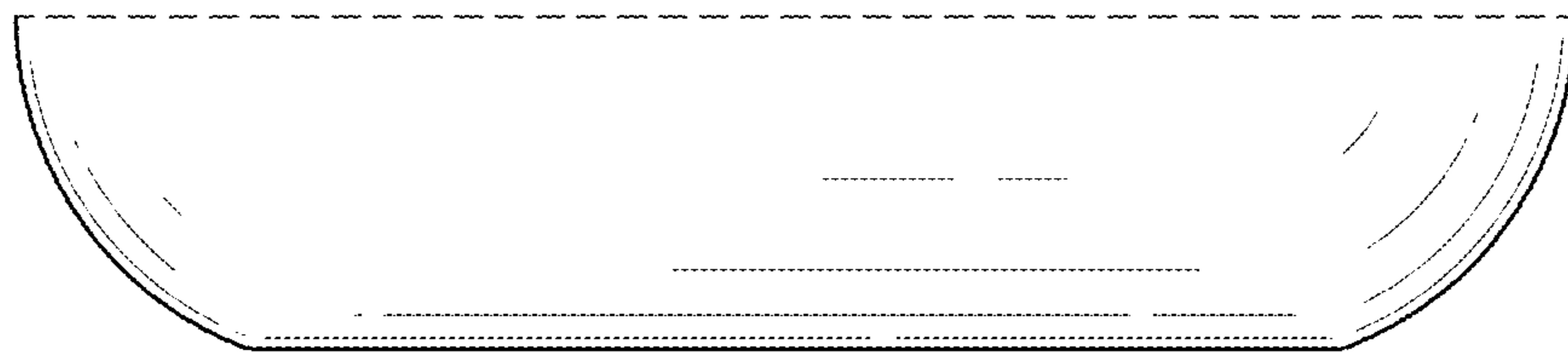

FIG.6



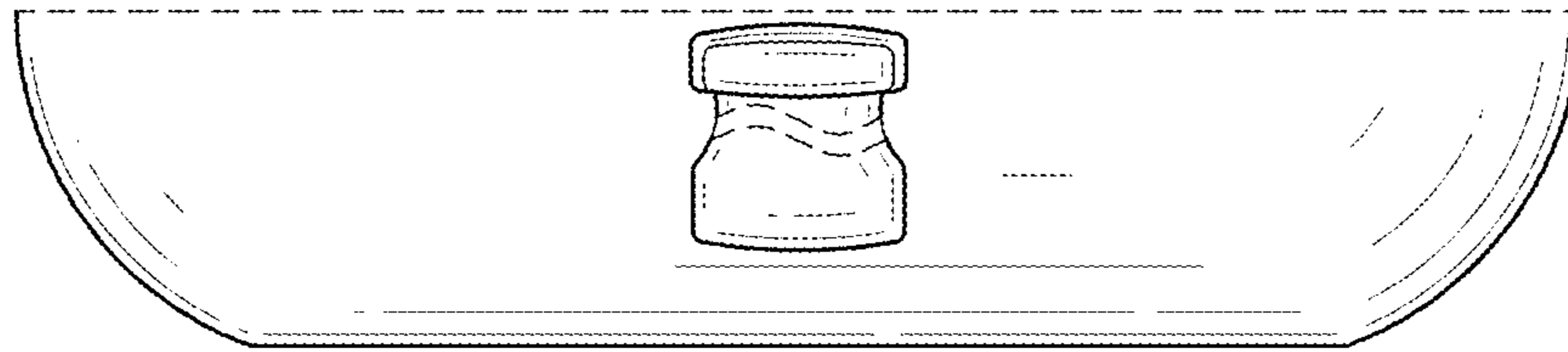

FIG.7