



US00D799220S

(12) **United States Design Patent** (10) **Patent No.:** **US D799,220 S**  
**van Breugel et al.** (45) **Date of Patent:** **\*\* Oct. 10, 2017**

(54) **CHILD’S SEAT**  
(71) Applicant: **Thule Sweden AB**, Hillerstorp (SE)

D688,474 S \* 8/2013 Tu ..... D6/333  
D727,640 S 4/2015 Carell  
D727,641 S 4/2015 Eriksson

(72) Inventors: **Gert-Jan van Breugel**, Tuil (NL); **Jort Nijhuis**, Amsterdam (NL); **Albert Nieuwenhuis**, Geldermalsen (NL); **Joline Karelse**, Utrecht (NL)

**OTHER PUBLICATIONS**

Yepp.com, “Mini”, <<http://web.archive.org/web/20150813030705/http://www.yepp.nl/en/product/mini/>>, dated Jul. 3, 2015.  
Yepp.com, “Maxi”, <<http://web.archive.org/web/20151127121935/http://www.yepp.nl/en/product/maxi/>>, dated Jul. 3, 2015.  
Design U.S. Appl. No. 29/572,171, filed Jul. 26, 2016; Larsson et al.  
Design U.S. Appl. No. 29/572,272, filed Jul. 26, 2016; van Breugel et al.

(73) Assignee: **Thule Sweden AB**, Hillerstorp (SE)

(\*\*) Term: **15 Years**

\* cited by examiner

(21) Appl. No.: **29/572,383**

(22) Filed: **Jul. 27, 2016**

*Primary Examiner* — Abraham Bahta

(51) **LOC (10) Cl.** ..... **06-01**

(74) *Attorney, Agent, or Firm* — Sterne, Kessler, Goldstein & Fox P.L.L.C.

(52) **U.S. Cl.**

USPC ..... **D6/333**

(58) **Field of Classification Search**

USPC ..... D6/333–336, 339, 344, 702, 716, D6/716.1–716.7; 297/183.1–183.4, 297/184.13, 184.15, 184.17, 250.1, 255, 297/256.1, 256.15, 219.12, 463.1; D12/129–130, 133; D21/412, 428, 419; 280/30–31; 5/94, 98.1, 99.1, 101–102, 5/105, 655, 93.1, 12.1; 24/200  
CPC . B60N 2/00; B60N 2/005; B60N 2/24; B60N 2/015; B60N 2/42; B60N 2/26; A47C 13/00; A47C 4/54; A47C 4/00; A47C 4/02; A47C 3/029; A47C 3/025; A47C 3/021; A47C 3/0252; A47D 1/00; A47D 1/006; A47D 1/06; A47D 1/002; A47D 1/004

See application file for complete search history.

(57) **CLAIM**

The ornamental design for a child’s seat, as shown and described.

**DESCRIPTION**

FIG. 1 is a top front perspective view of a child’s seat showing the claimed design;  
FIG. 2 is a bottom rear perspective view thereof;  
FIG. 3 is a front view thereof;  
FIG. 4 is a rear view thereof;  
FIG. 5 is a left side view thereof;  
FIG. 6 is a right side view thereof;  
FIG. 7 is a top view thereof; and,  
FIG. 8 is a bottom view thereof.  
The broken lines in the figures show portions of the child’s seat that form no part of the claimed design.

(56) **References Cited**

**U.S. PATENT DOCUMENTS**

D336,785 S \* 6/1993 Matsuda ..... D6/333  
D613,955 S \* 4/2010 Kho ..... D6/333

**1 Claim, 8 Drawing Sheets**

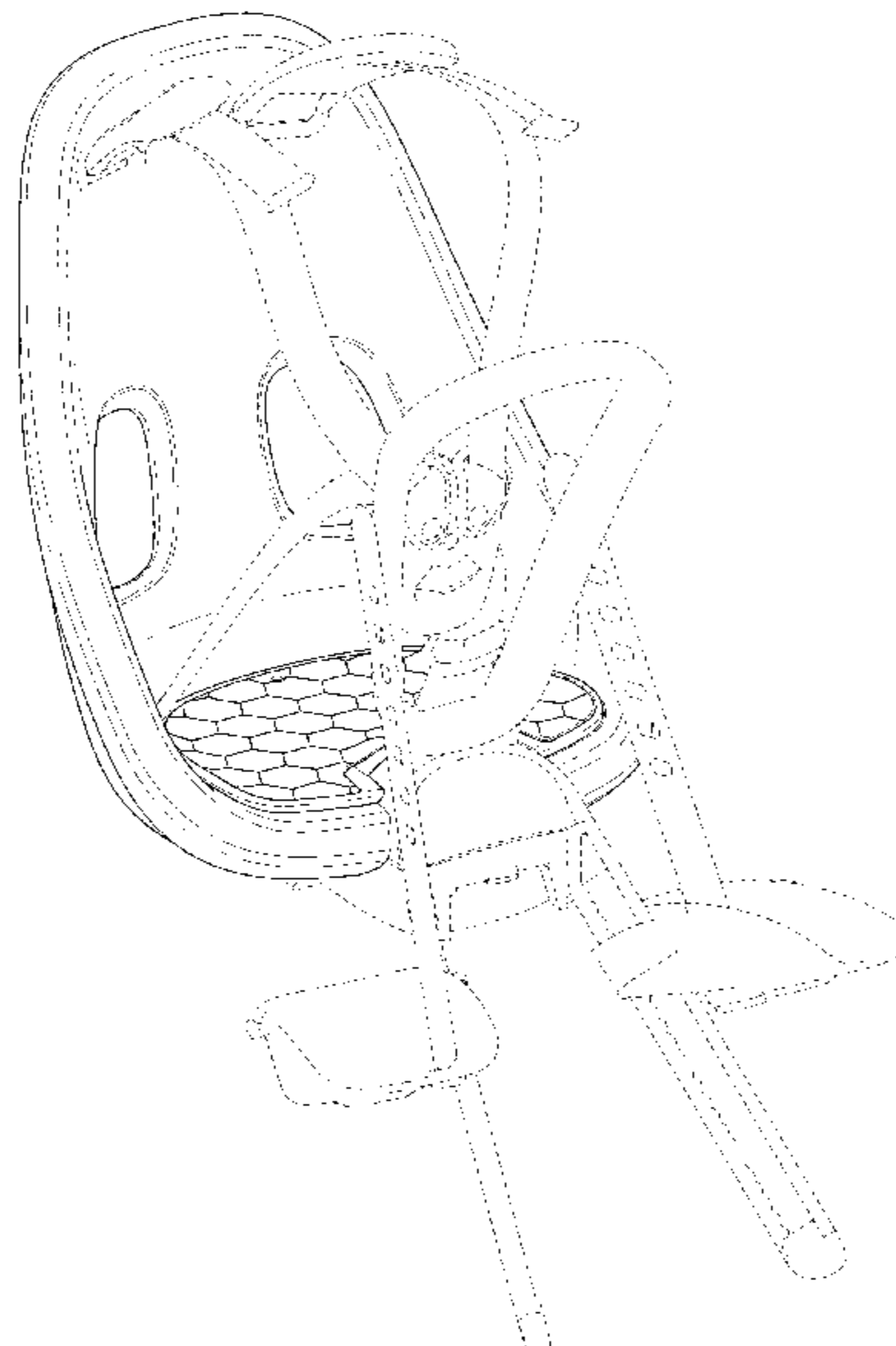

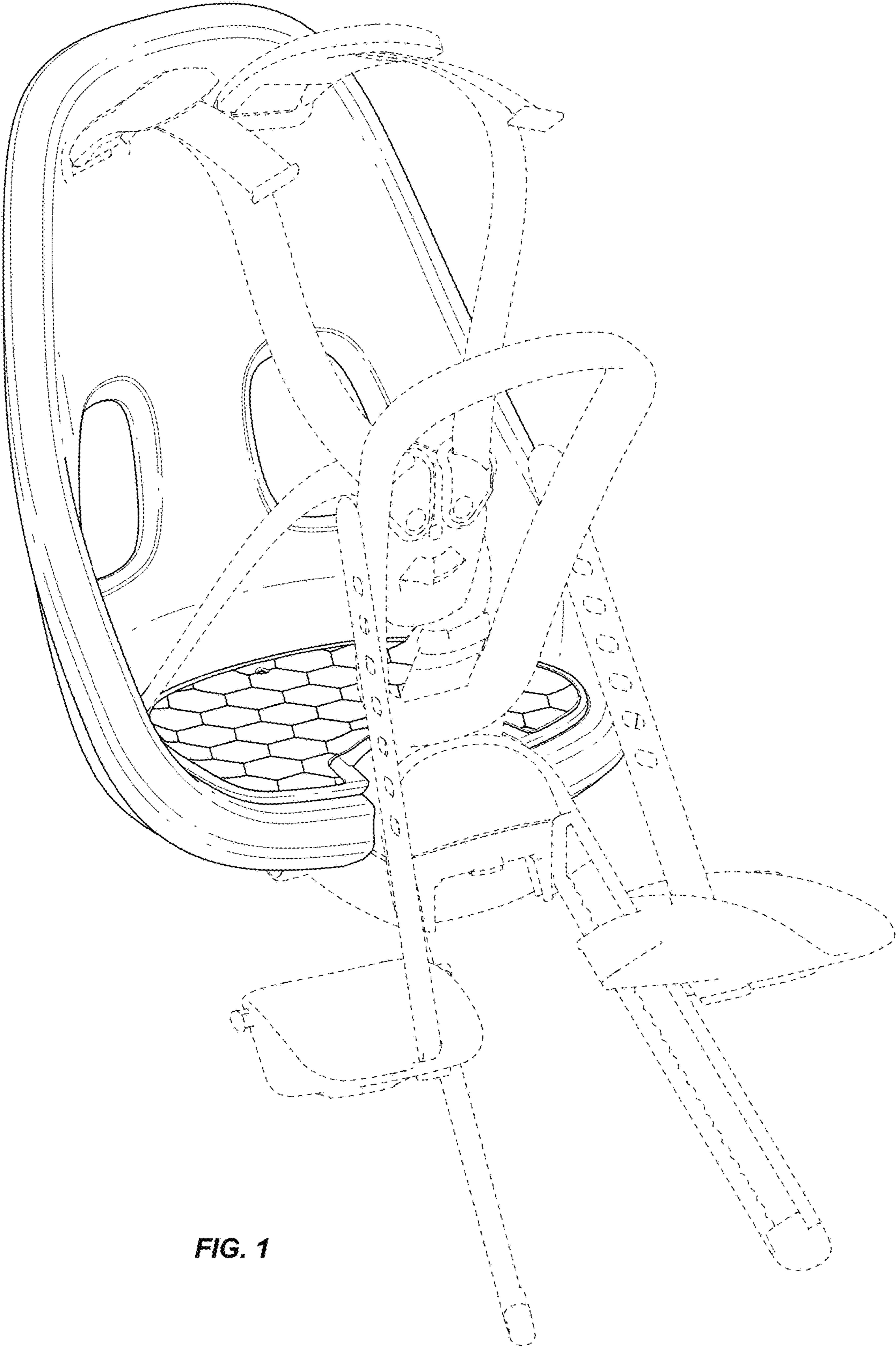

FIG. 1

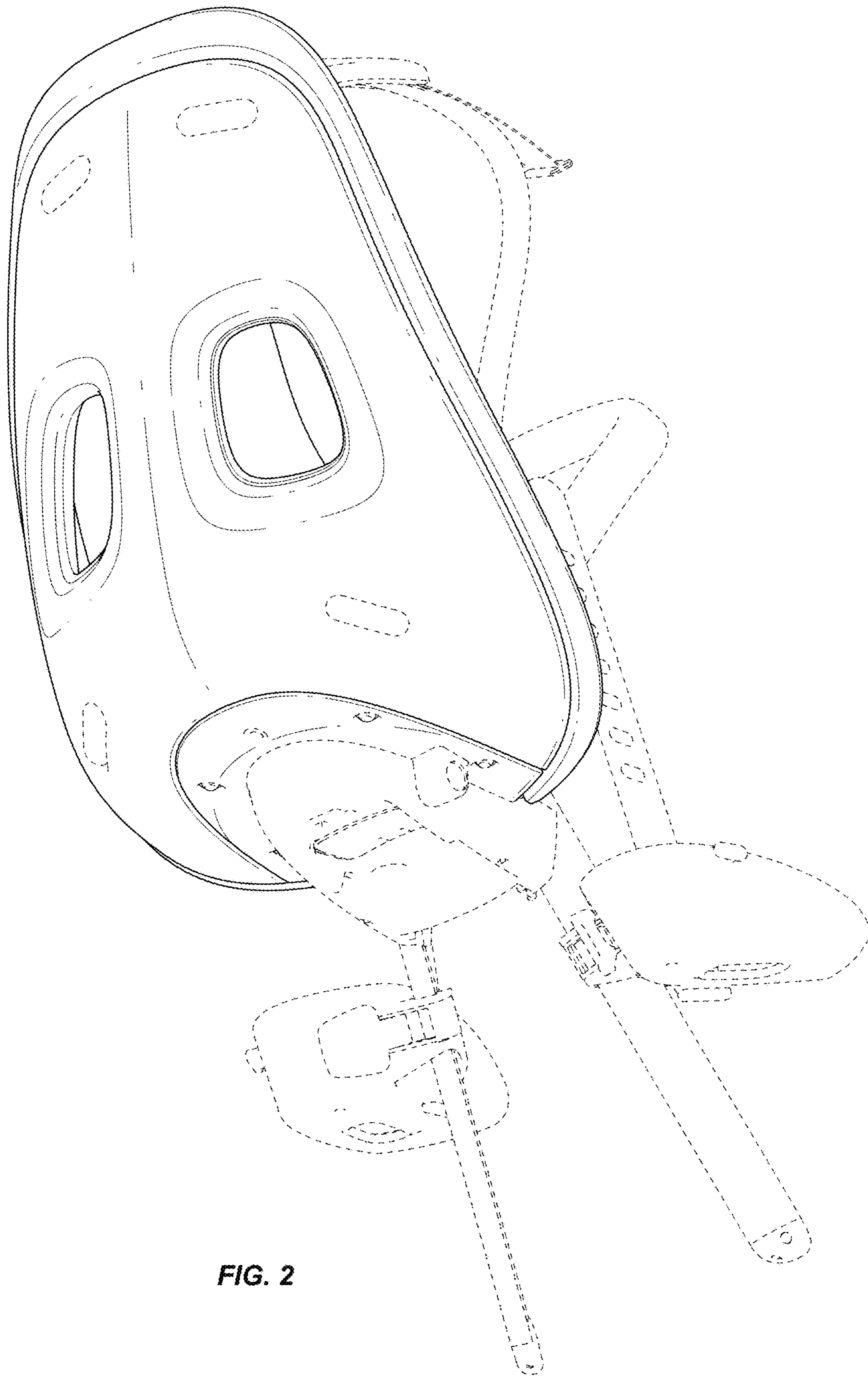

FIG. 2

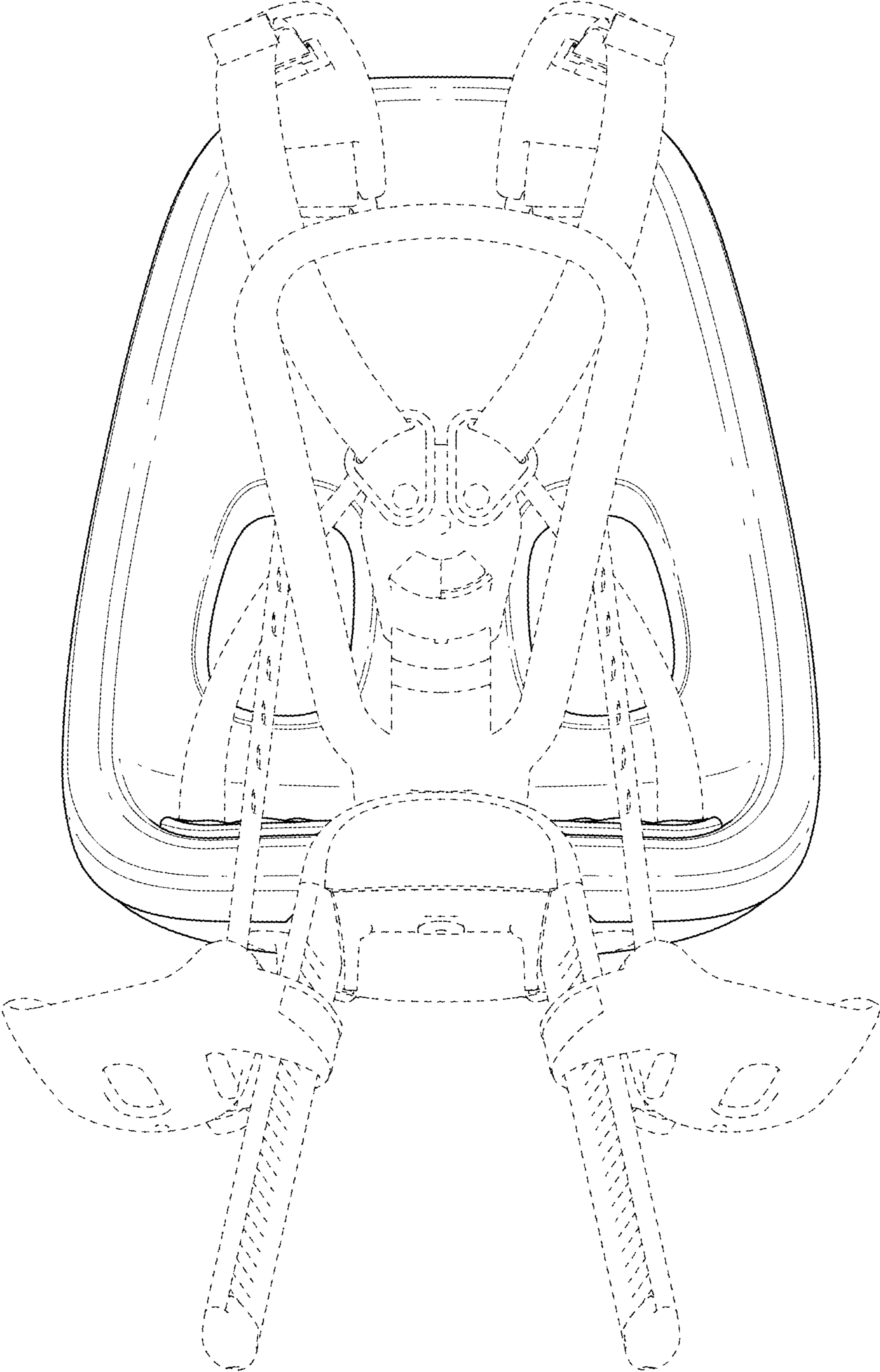

FIG. 3

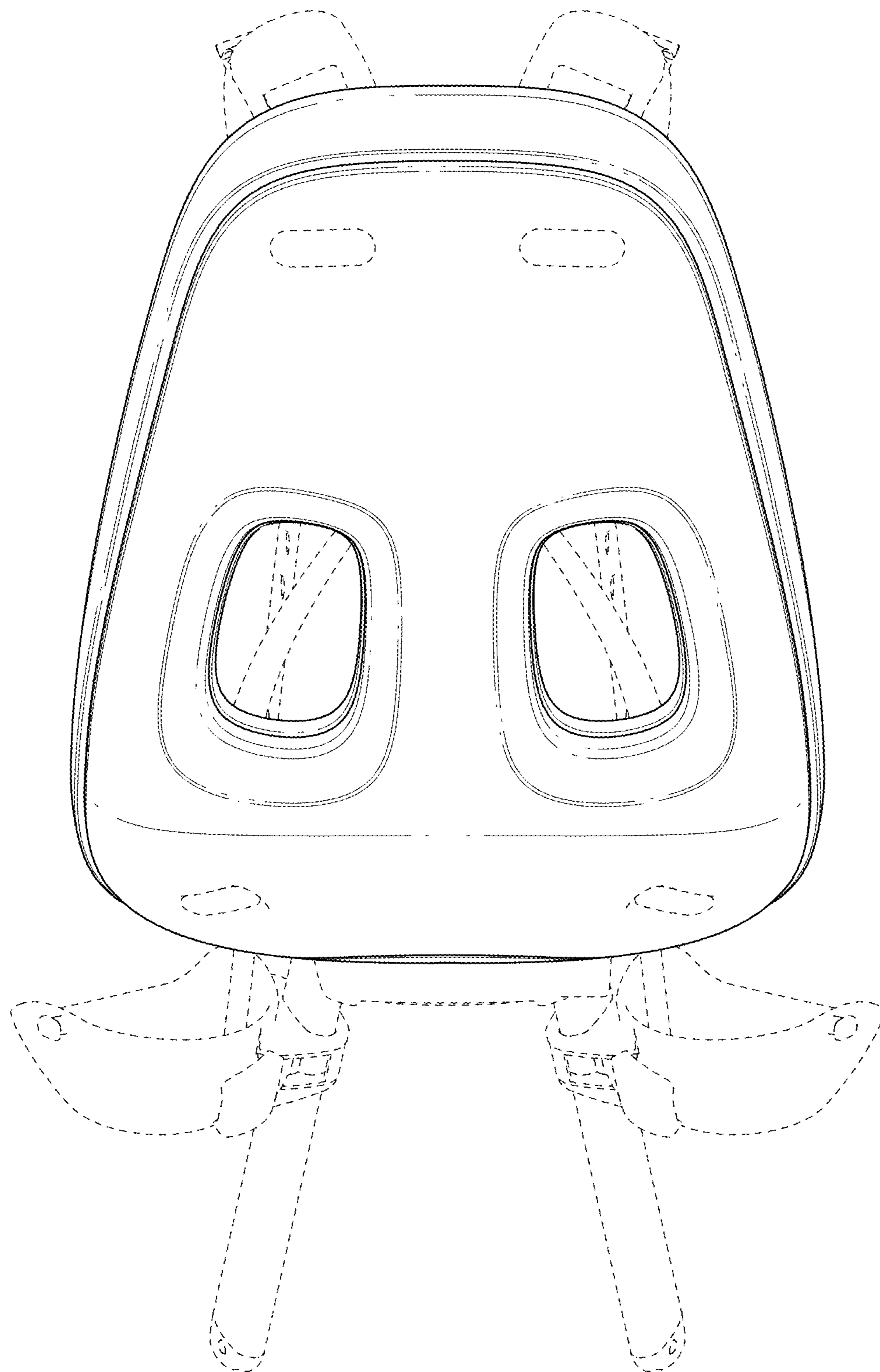

FIG. 4

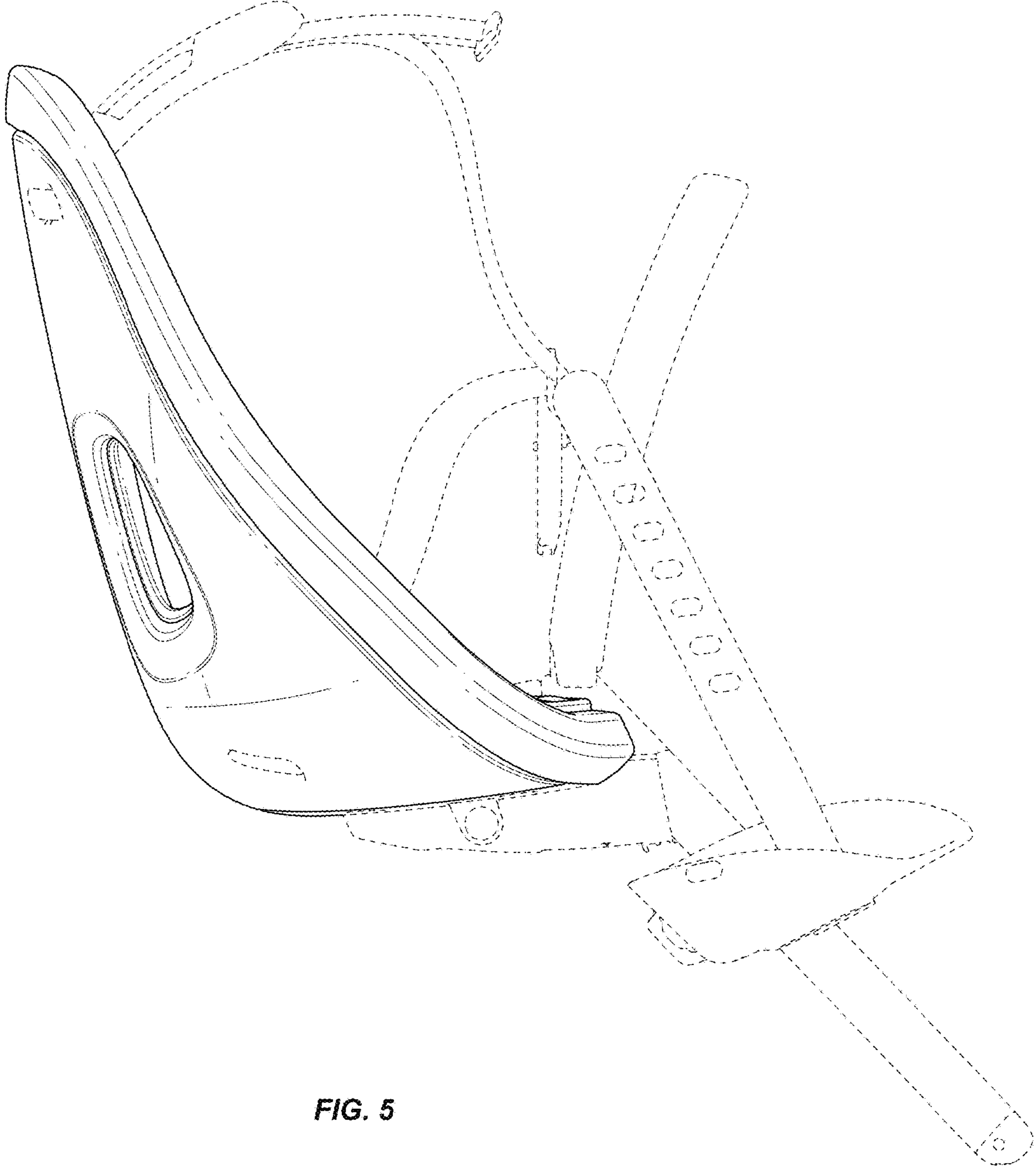

FIG. 5

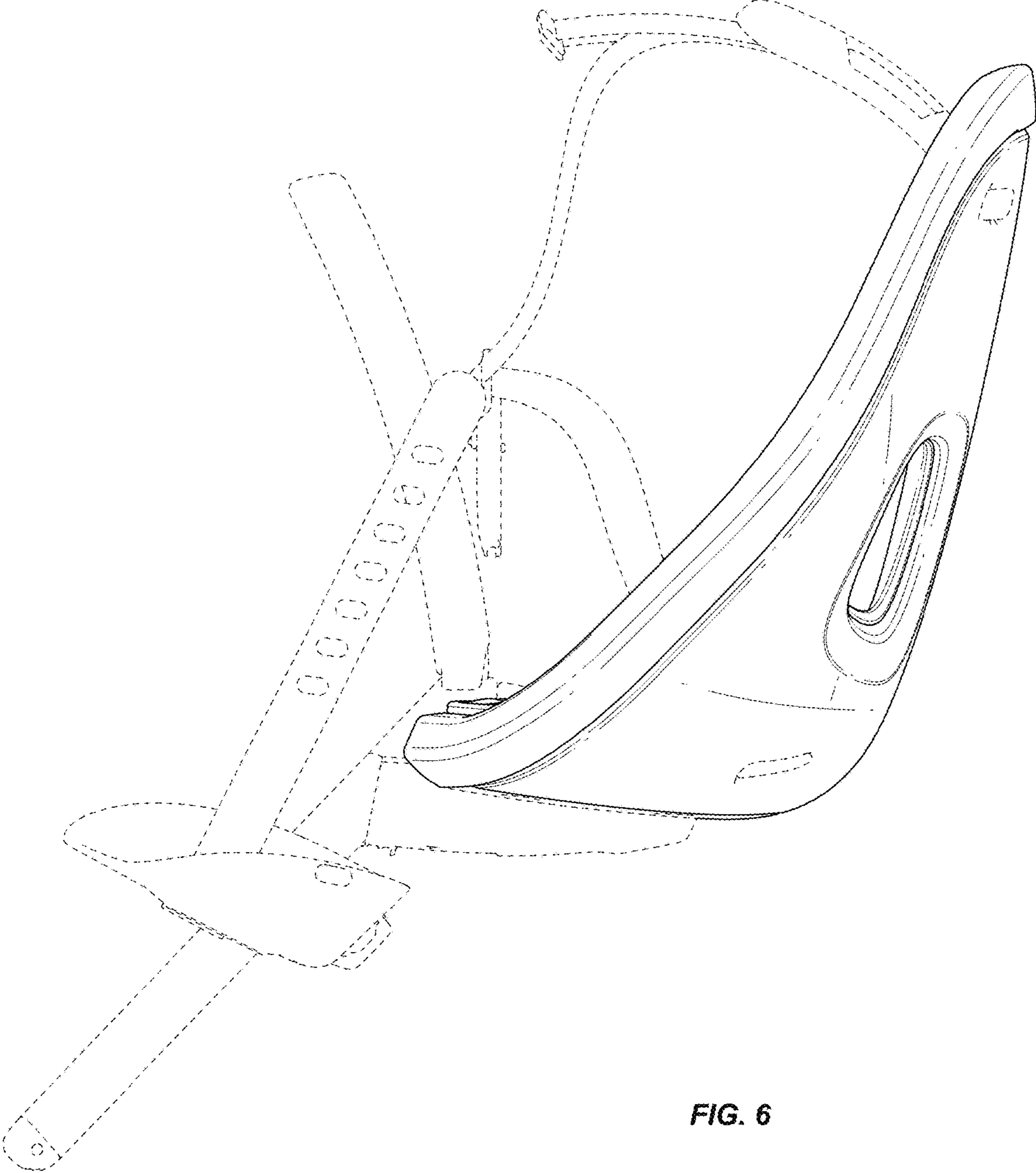

FIG. 6

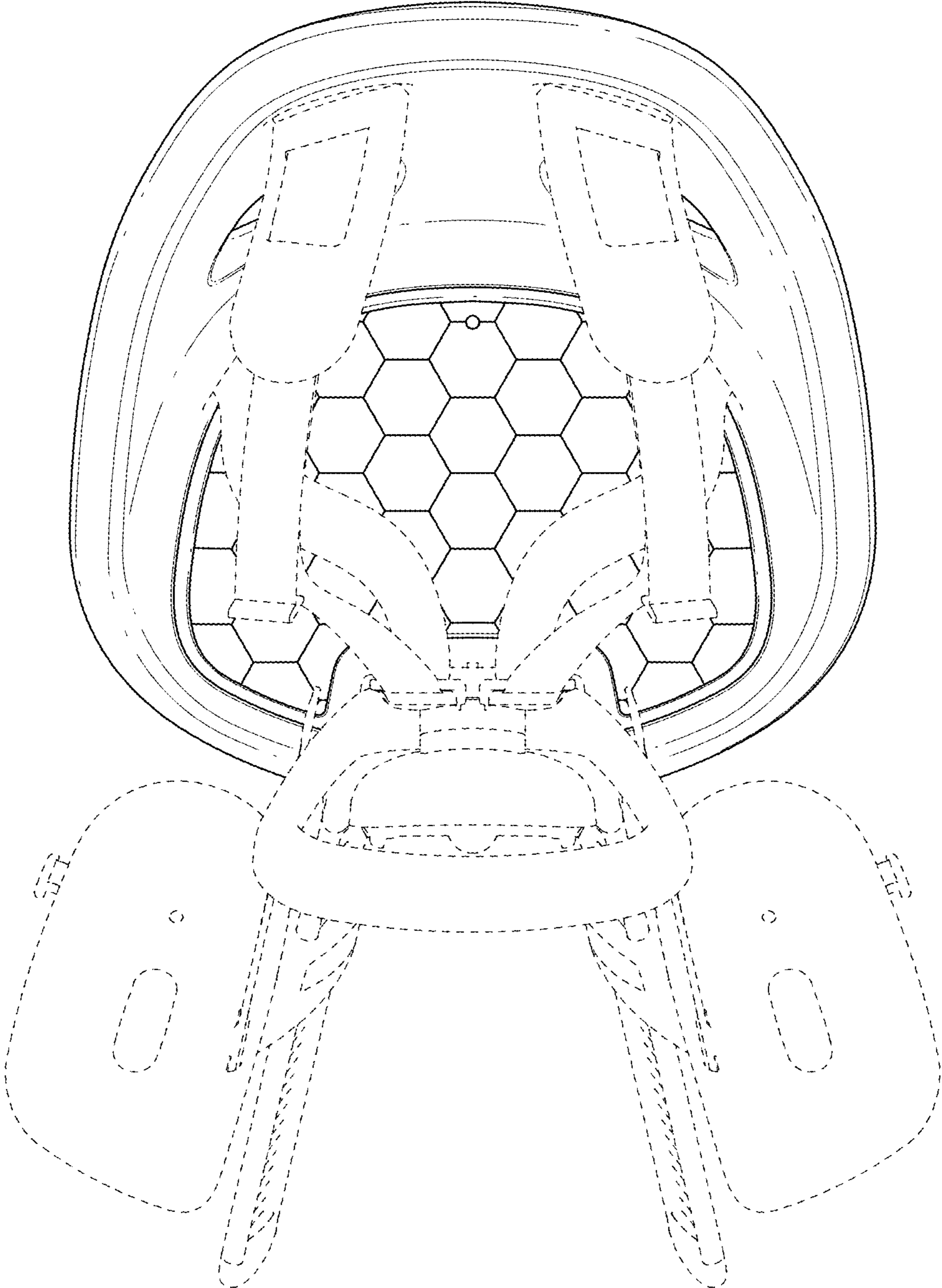

FIG. 7



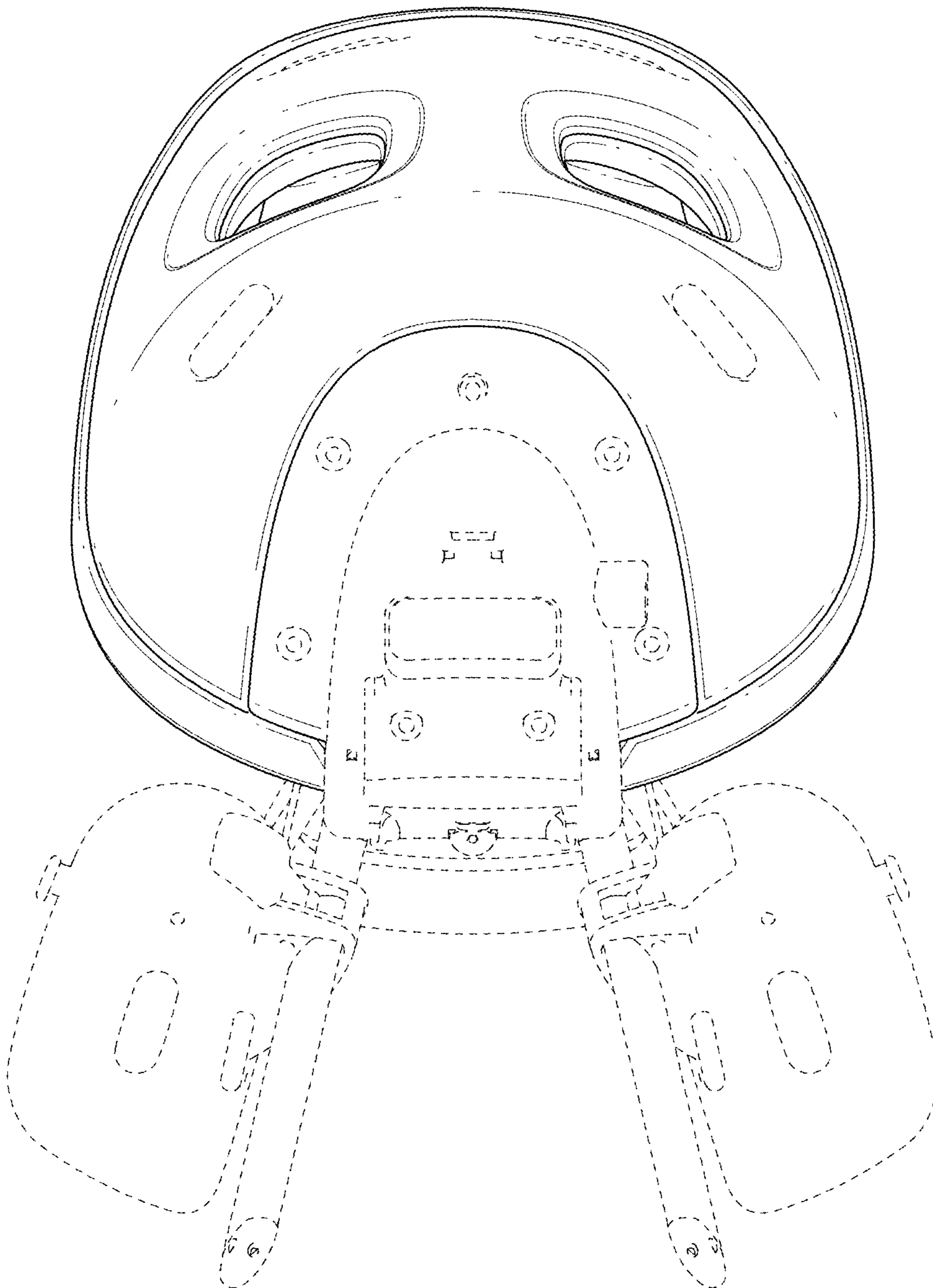

FIG. 8