



US00D799175S

(12) **United States Design Patent** (10) **Patent No.:** **US D799,175 S**
Leva et al. (45) **Date of Patent:** **** Oct. 10, 2017**

(54) **SHOE**

(71) Applicant: **Sea Star Beachwear, LLC**, New York, NY (US)

(72) Inventors: **Michael Leva**, New York, NY (US);
Lida E. Fitzgerald, New York, NY (US)

(73) Assignee: **Sea Star Beachwear, LLC**, New York, NY (US)

(**) Term: **15 Years**

(21) Appl. No.: **29/599,955**

(22) Filed: **Apr. 7, 2017**

Related U.S. Application Data

(63) Continuation-in-part of application No. 29/557,755, filed on Mar. 11, 2016, now Pat. No. Des. 784,664.

(51) **LOC (10) Cl.** **02-04**

(52) **U.S. Cl.**
USPC **D2/923**

(58) **Field of Classification Search**
USPC D2/896-945
CPC A43B 21/00; A43B 21/02; A43B 21/025; A43B 21/03; A43B 21/04; A43B 21/06; A43B 21/08; A43B 21/18; A43B 21/20; A43B 21/22; A43B 21/24; A43B 21/26; A43B 21/265; A43B 21/28; A43B 21/285; A43B 21/30; A43B 21/32; A43B 21/36; A43B 21/37; A43B 21/38; A43B 21/39; A43B 21/40; A43B 21/42; A43B 21/433; A43B 21/437; A43B 21/44; A43B 21/45; A43B 21/46; A43B 21/47; A43B 21/48; A43B 21/50; A43B 21/51; A43B 21/52; A43B 21/54

See application file for complete search history.

(56) **References Cited**

U.S. PATENT DOCUMENTS

D252,297 S *	7/1979	Castaner Vinas	D2/927
D333,376 S *	2/1993	Raffe	D2/969
D377,264 S *	1/1997	Wunsch	D2/947
D517,784 S *	3/2006	Wilkenfeld	D2/902
D530,888 S *	10/2006	Kim	D2/896
D609,885 S *	2/2010	Briggs	D2/910
D640,861 S *	7/2011	Wilkenfeld	D2/896
D649,752 S *	12/2011	Kampff	D2/911
D650,973 S *	12/2011	Panariello	D2/919

(Continued)

OTHER PUBLICATIONS

Clarks Suede Slip-on Espadrilles—Azella Theoni, posted at qvc.com, earliest date available Jul. 30, 2016, [online], acquired on Jun. 7, 2017. Available from Internet, <URL: <http://www.qvc.com/Clarks-Suede-Slip-on-Espadrilles---Azella-Theoni.product.A288101.html>>.*

(Continued)

Primary Examiner — Cathron Brooks

Assistant Examiner — Aula Soroush

(74) *Attorney, Agent, or Firm* — Graham Curtin, P.A.

(57) **CLAIM**

The ornamental design for a shoe, as shown and described.

DESCRIPTION

FIG. 1 is a perspective view of a shoe showing our new design;
FIG. 2 is a side elevation view thereof;
FIG. 3 is a side elevation view thereof;
FIG. 4 is a top plan view thereof;
FIG. 5 is a front elevation view thereof; and,
FIG. 6 is a back elevation view.

(Continued)

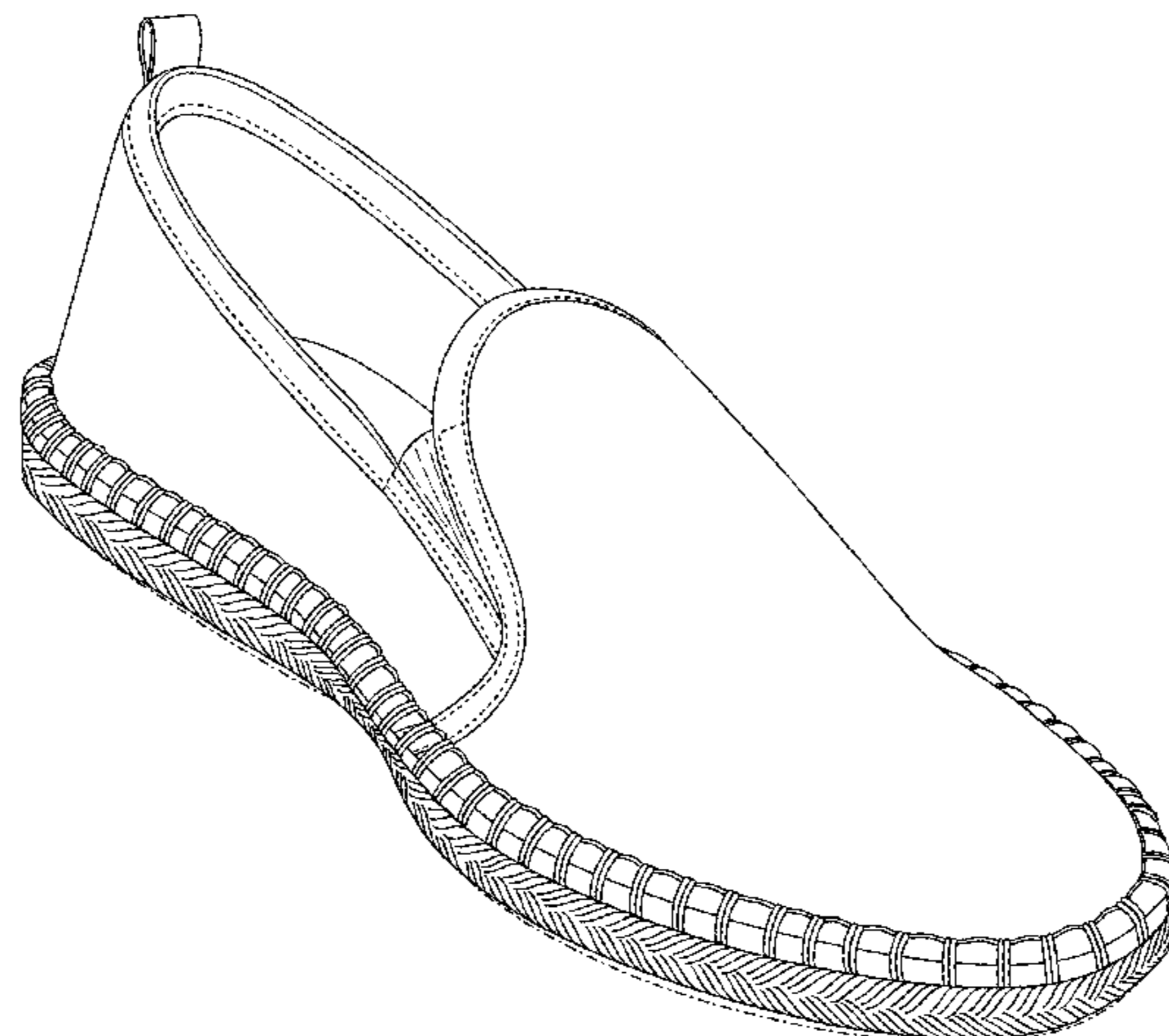

The broken lines in the drawings illustrate threading that form no part of the claimed design. The dot-dash lines show portions of the shoe and form no part of the claimed design.

1 Claim, 3 Drawing Sheets

(56)

References Cited

U.S. PATENT DOCUMENTS

D653,841	S	*	2/2012	Menezes	D2/923
D719,325	S	*	12/2014	Sassi	D2/919
D724,825	S	*	3/2015	Kampff	D2/929
D730,636	S	*	6/2015	Della Valle	D2/939
D738,599	S	*	9/2015	Sassi	D2/929
D783,242	S	*	4/2017	Arzegar	D2/923
D784,664	S	*	4/2017	Leva	D2/923
D787,165	S	*	5/2017	Sassi	D2/896

OTHER PUBLICATIONS

Vans Slip-On Espadrille Shoes—Women's, posted at evo.com, earliest date available: unknown, [online], acquired on Jun. 7, 2017. Available from Internet, <URL: <http://www.evo.com/outlet/shoes/vans-slip-on-espadrille-womens.aspx>>.*

These Statement-Making Espadrilles Are About to Change Your Summer Shoe Game, posted at evo.com, earliest date available: May 15, 2017, [online], acquired on Jun. 20, 2017. Available from Internet, <URL: <https://www.popsugar.com/fashion/Graphic-Espadrilles-43536810#photo-43536857>>.*

* cited by examiner

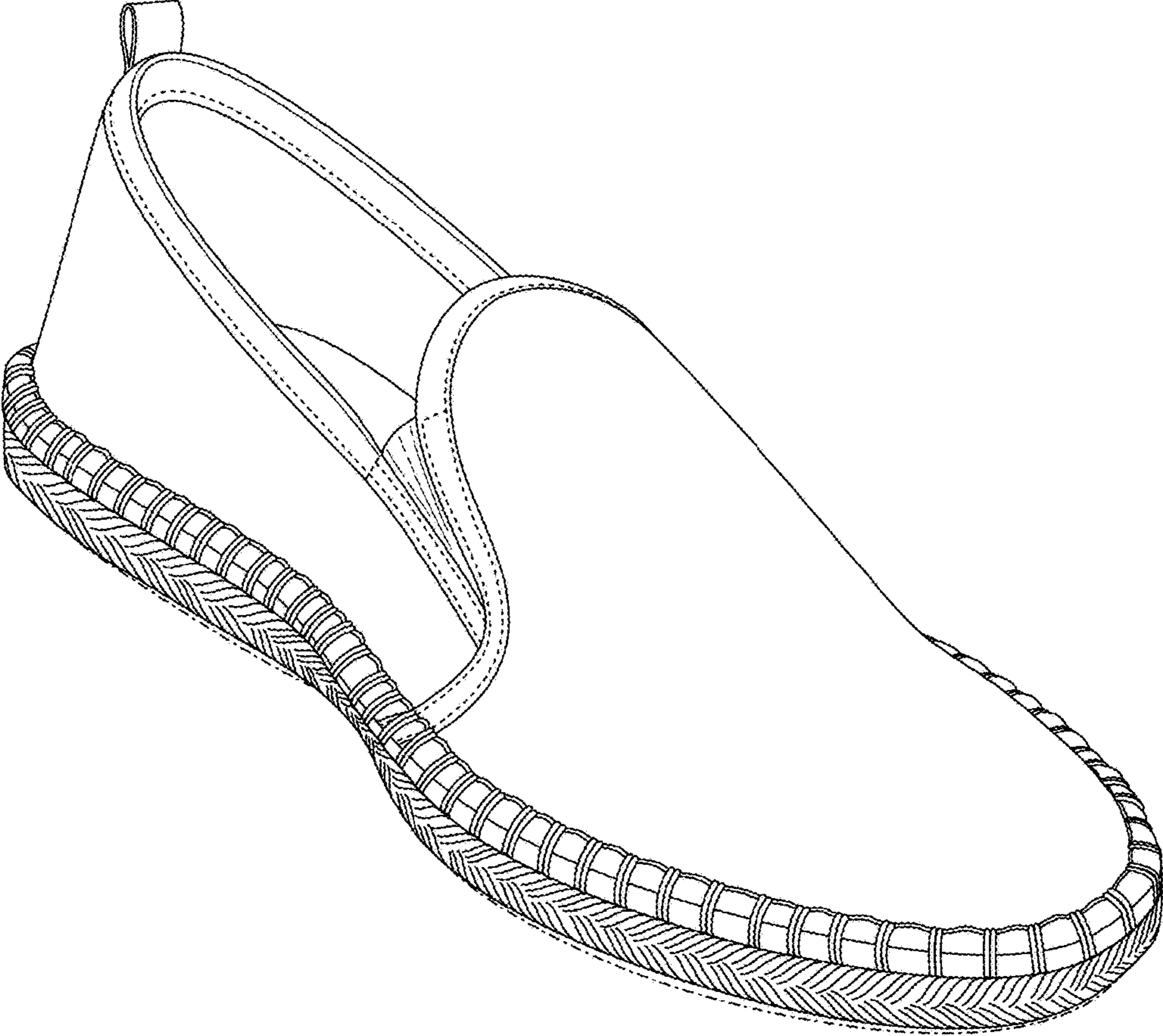

FIG. 1

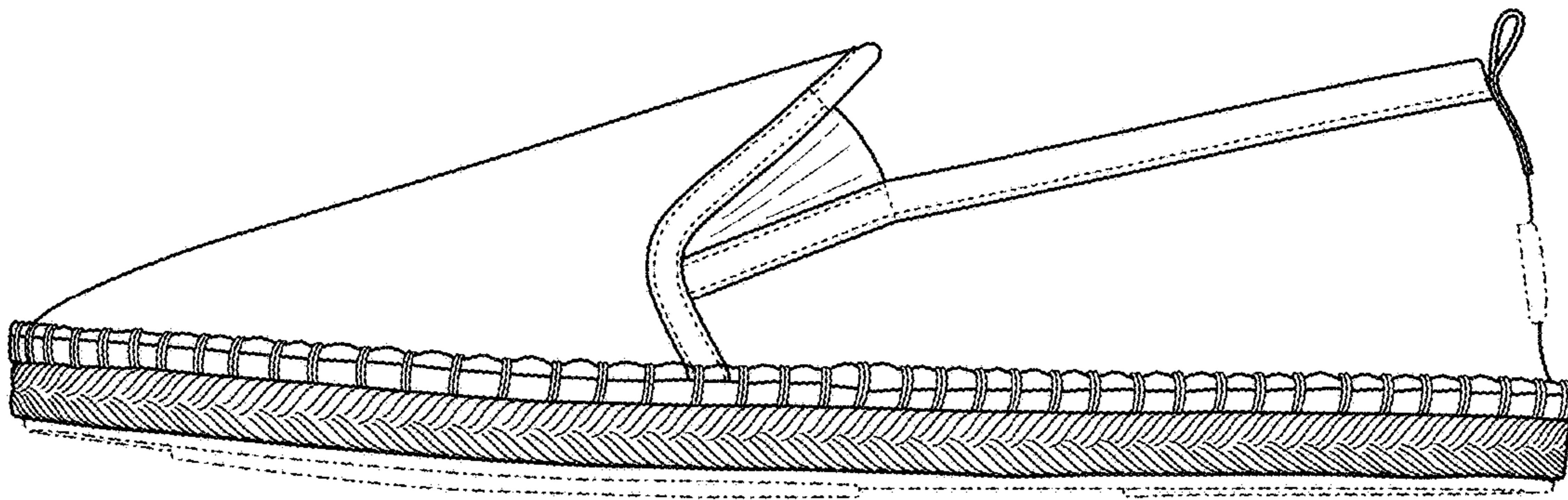

FIG. 2

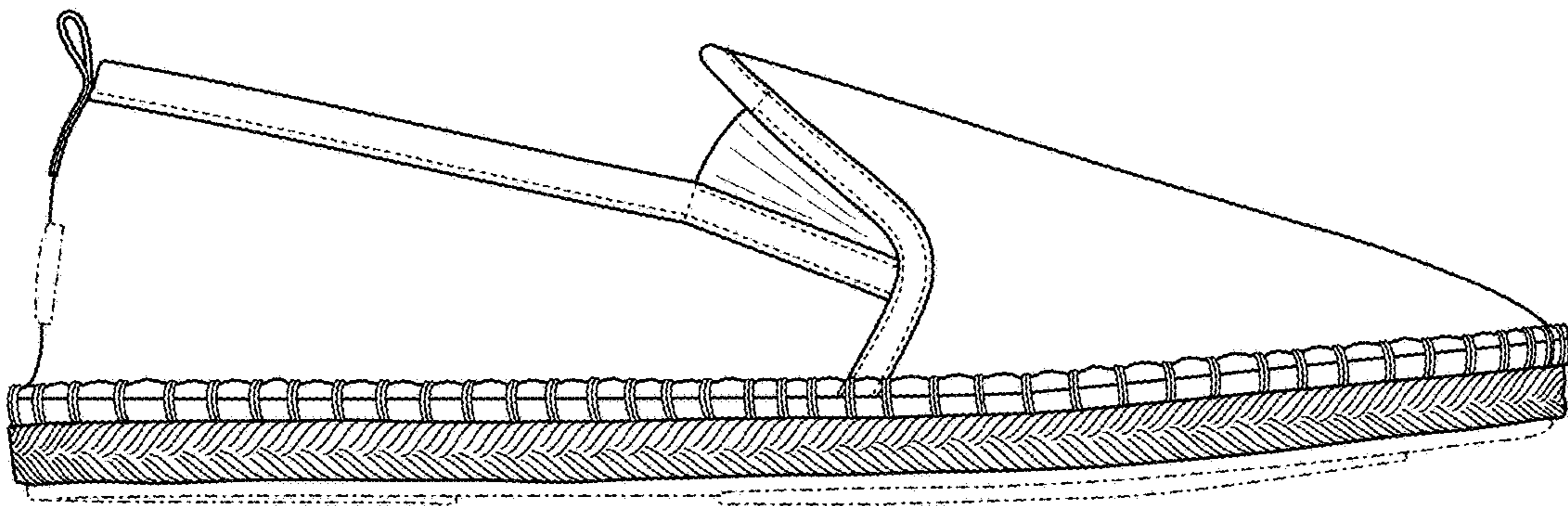

FIG. 3

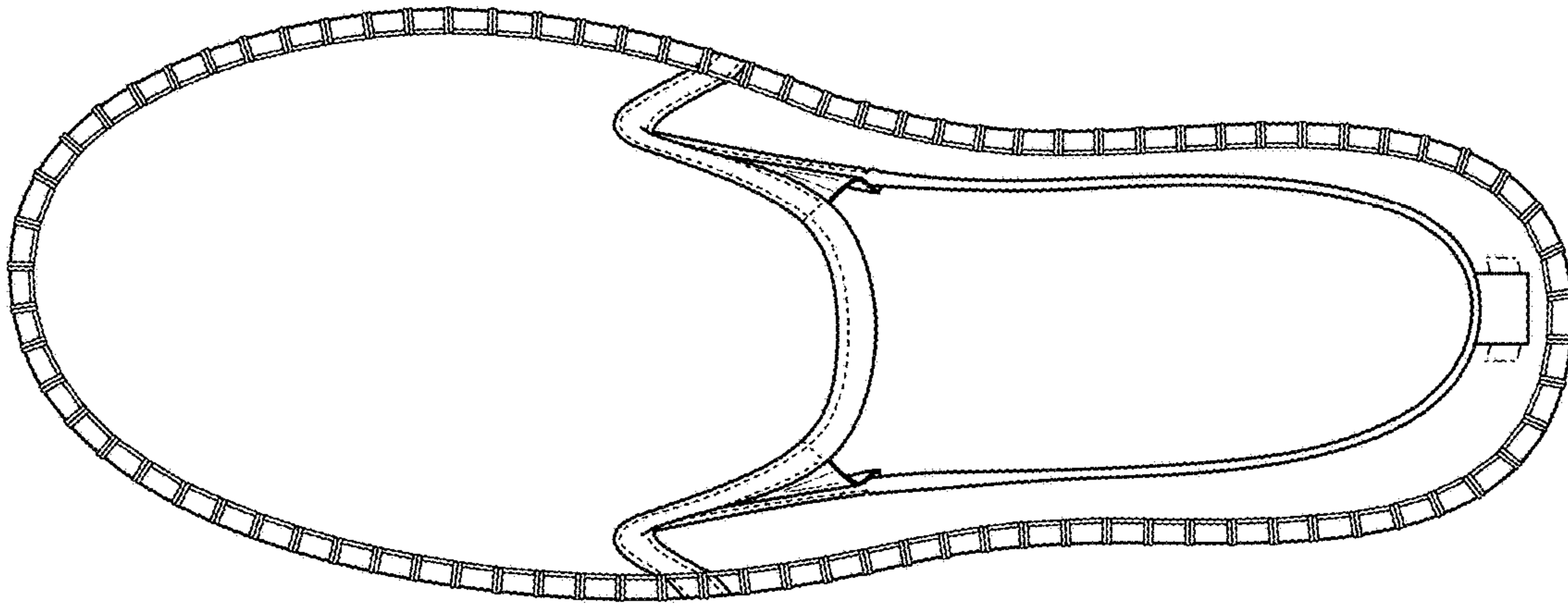

FIG. 4

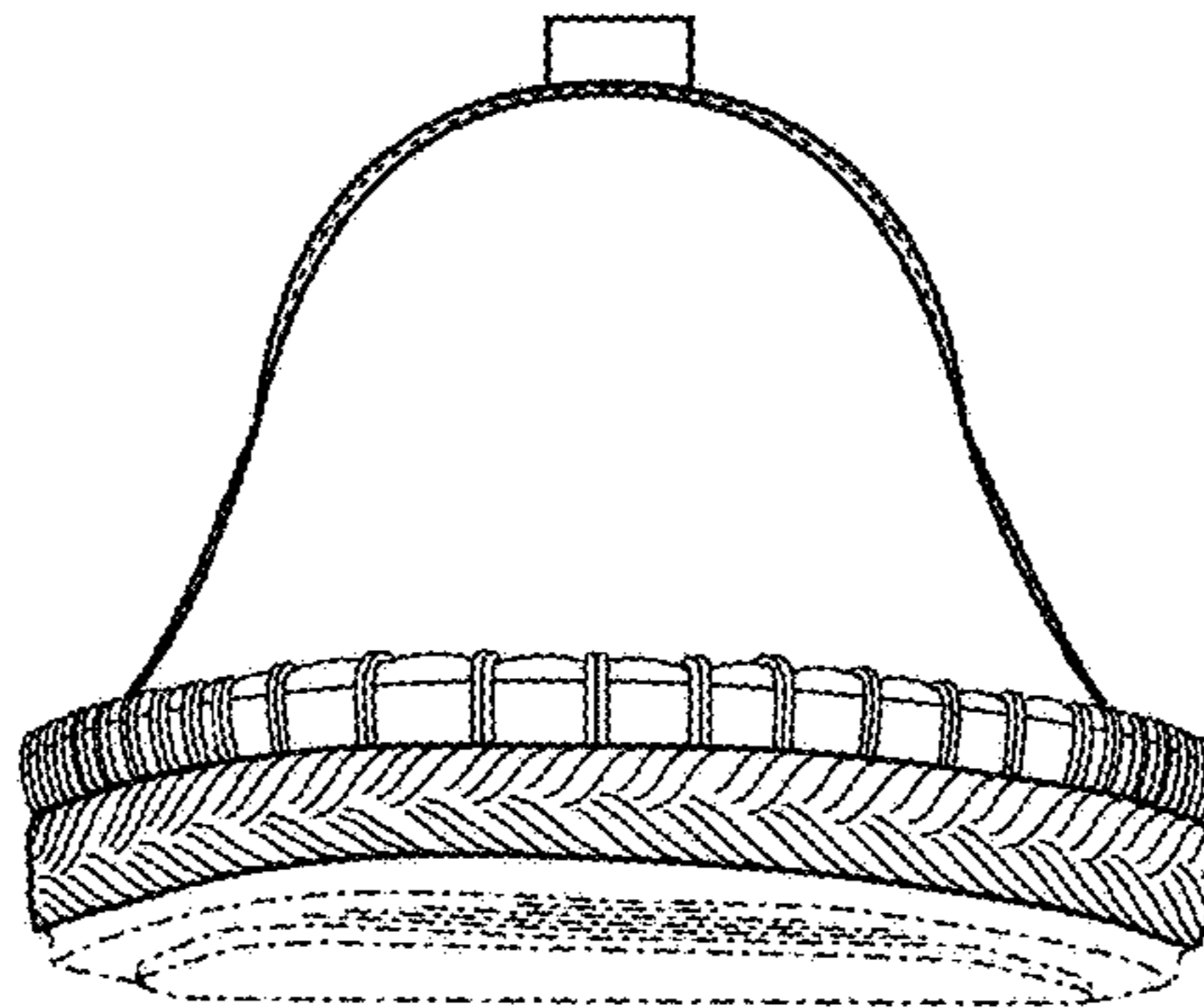

FIG. 5

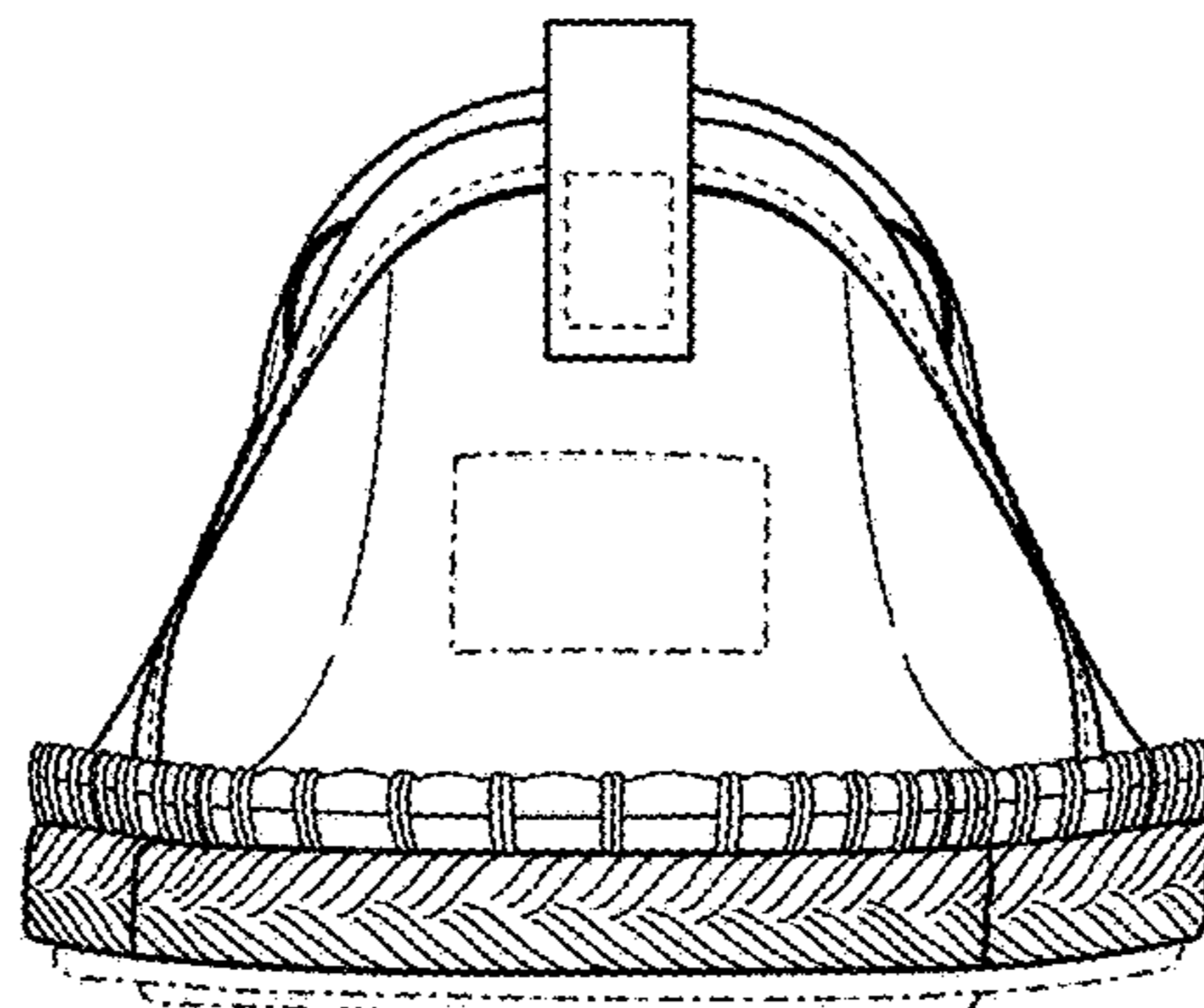

FIG. 6