



US00D799118S

(12) **United States Design Patent** (10) **Patent No.:** **US D799,118 S**  
**Ino** (45) **Date of Patent:** **\*\* Oct. 3, 2017**

(54) **ELECTRIC SHAVER**

FOREIGN PATENT DOCUMENTS

(71) Applicant: **Panasonic Intellectual Property Management Co., Ltd., Osaka (JP)**

JP	D1434994	3/2012
JP	D1435333	3/2012
JP	D1451929	10/2012
JP	D1518917	3/2015
JP	D1532284	8/2015

(72) Inventor: **Tomoaki Ino, Kanagawa (JP)**

(73) Assignee: **Panasonic Intellectual Property Management Co., Ltd., Osaka (JP)**

\* cited by examiner

(\*\*) Term: **15 Years**

*Primary Examiner* — Jennifer Rivard

(21) Appl. No.: **29/553,428**

(74) *Attorney, Agent, or Firm* — Panasonic IP Management; Kerry S. Culpepper

(22) Filed: **Feb. 1, 2016**

(57) **CLAIM**

(30) **Foreign Application Priority Data**

I claim the ornamental design for an electric shaver, as shown and described.

Dec. 25, 2015	(JP)	.....	2015-028873
Dec. 25, 2015	(JP)	.....	2015-028874

(51) **LOC (10) Cl.** ..... **28-03**

**DESCRIPTION**

(52) **U.S. Cl.**  
USPC ..... **D28/51**

(58) **Field of Classification Search**  
USPC ..... D28/49-54  
CPC ..... B26B 19/00-19/107; B26B 19/12-19/22;  
B26B 19/24; B26B 19/26-19/36; B26B  
19/38-19/48  
See application file for complete search history.

FIG. 1 is a front perspective view of a first embodiment of an electric shaver of the present invention; FIG. 2 is a rear perspective view thereof; FIG. 3 is a front view thereof; FIG. 4 is a rear view thereof; FIG. 5 is a first side view thereof; FIG. 6 is a second side view thereof; FIG. 7 is a top view thereof; FIG. 8 is a bottom view thereof; FIG. 9 is a front perspective view of a second embodiment of an electric shaver of the present invention; FIG. 10 is a rear perspective view thereof; FIG. 11 is a front view thereof; FIG. 12 is a rear view thereof; FIG. 13 is a first side view thereof; FIG. 14 is a second side view thereof; FIG. 15 is a top view thereof; and, FIG. 16 is a bottom view thereof.

(56) **References Cited**

U.S. PATENT DOCUMENTS

D674,143	S	*	1/2013	Ino	.....	D28/51
D674,554	S	*	1/2013	Ino	.....	D28/51
D674,555	S	*	1/2013	Ino	.....	D28/51
D695,963	S	*	12/2013	Ino	.....	D28/51
D696,458	S	*	12/2013	Ino	.....	D28/51
D717,996	S	*	11/2014	Kikuchi	.....	D28/51
D718,495	S	*	11/2014	Okabe	.....	D28/51
D752,811	S	*	3/2016	Okabe	.....	D28/54
D753,342	S	*	4/2016	Okabe	.....	D28/51
D758,018	S	*	5/2016	Okabe	.....	D28/54
2008/0134515	A1	*	6/2008	Sato	.....	B26B 19/046 30/43.91

The broken lines illustrate portions of the electric shaver and form no part of the claimed design.

**1 Claim, 16 Drawing Sheets**

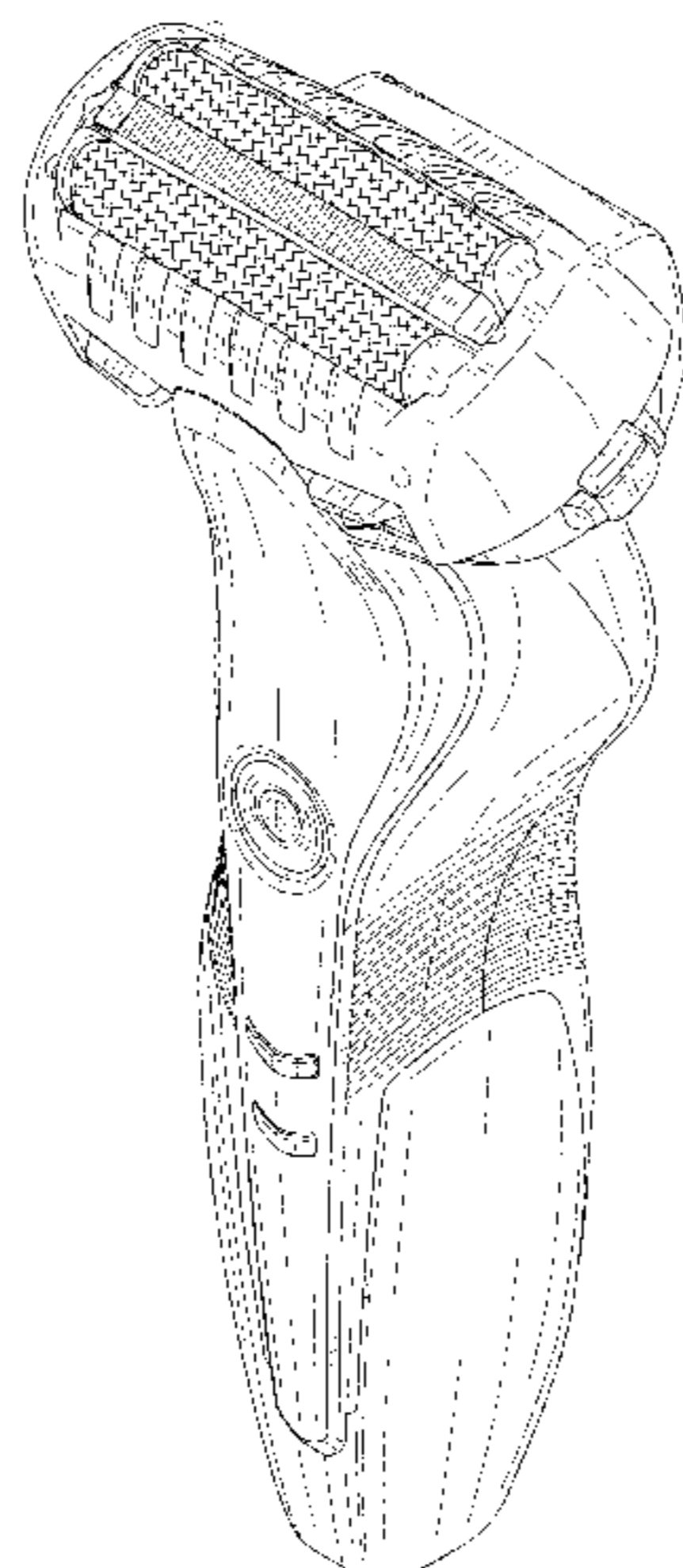

FIG. 1

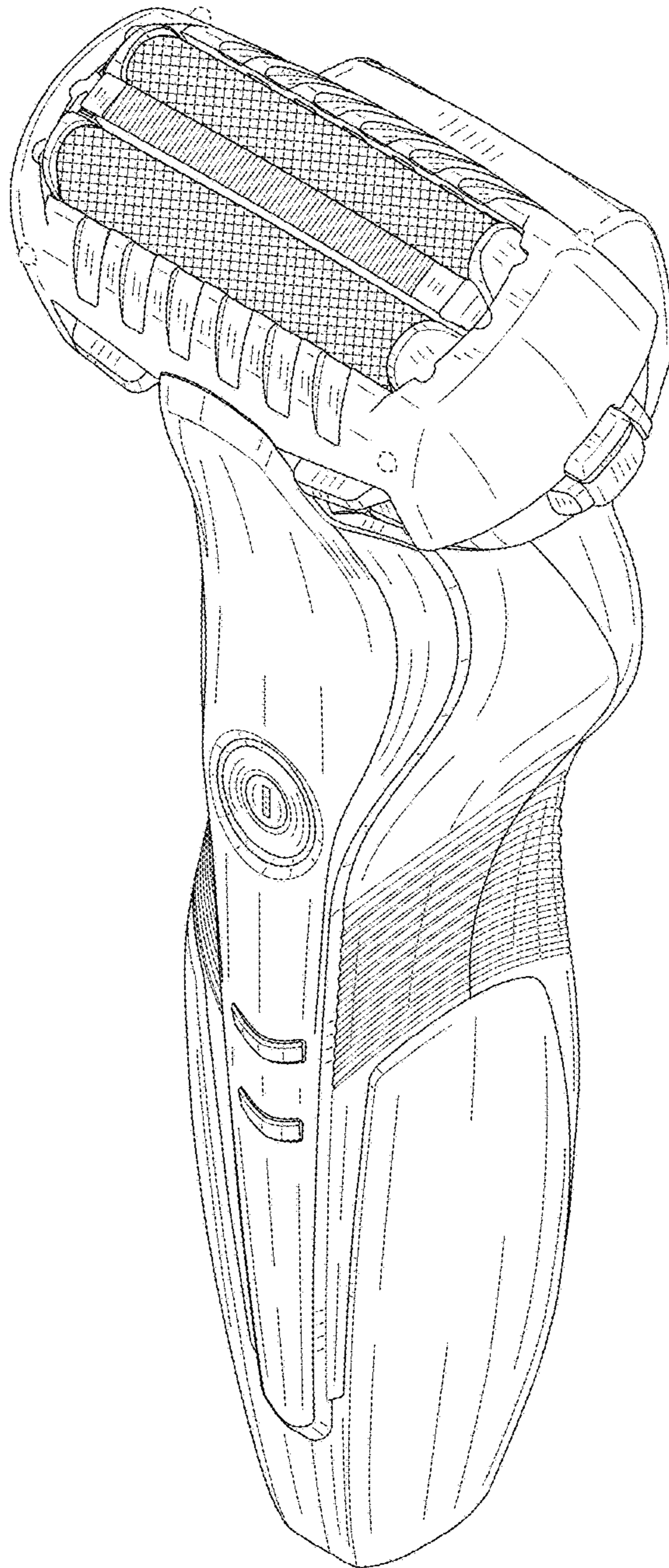

FIG. 2

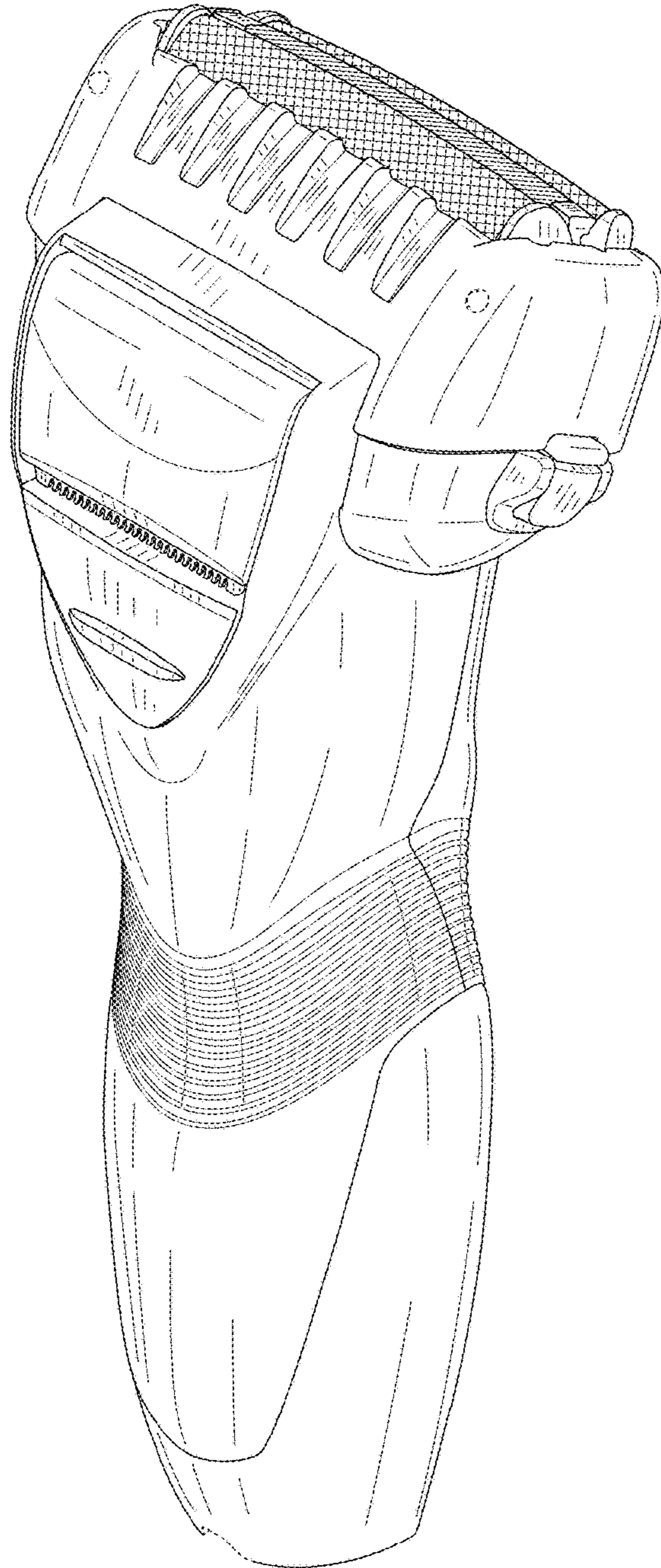



FIG. 3

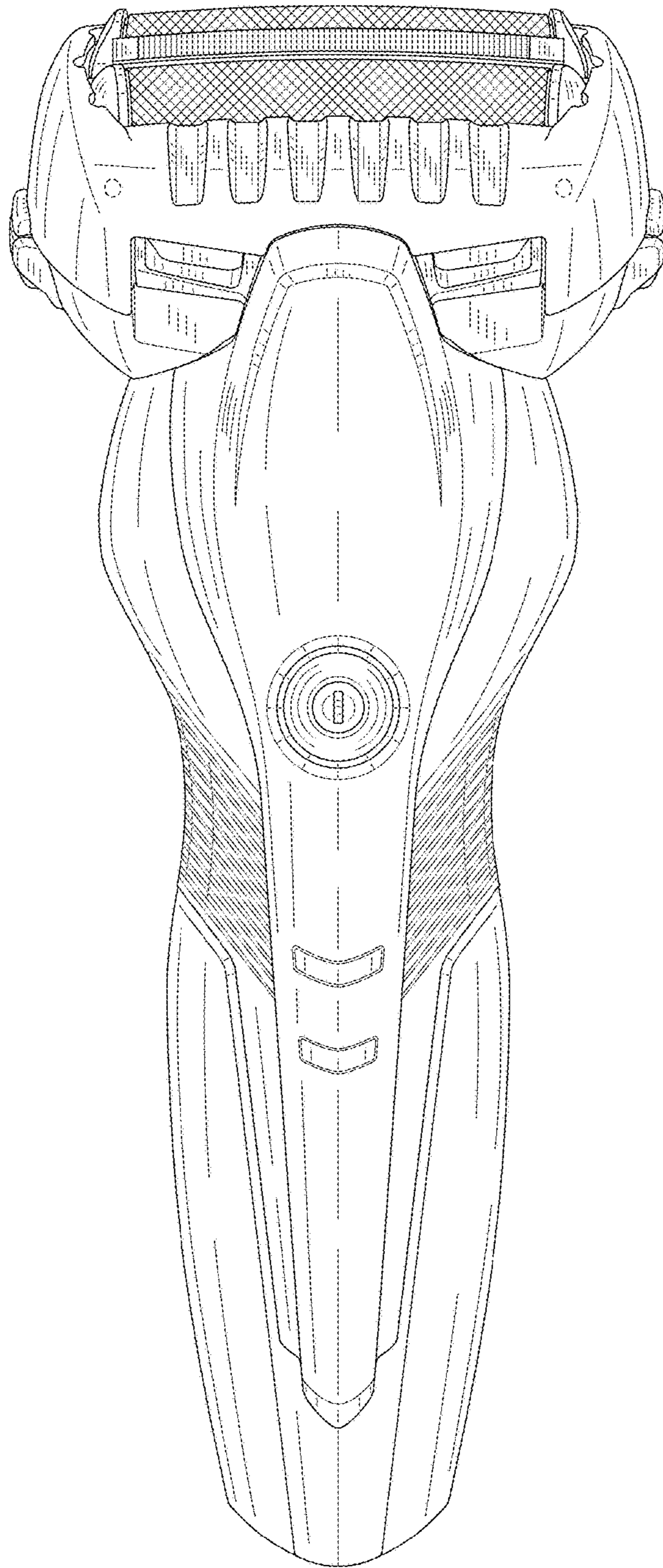

FIG. 4

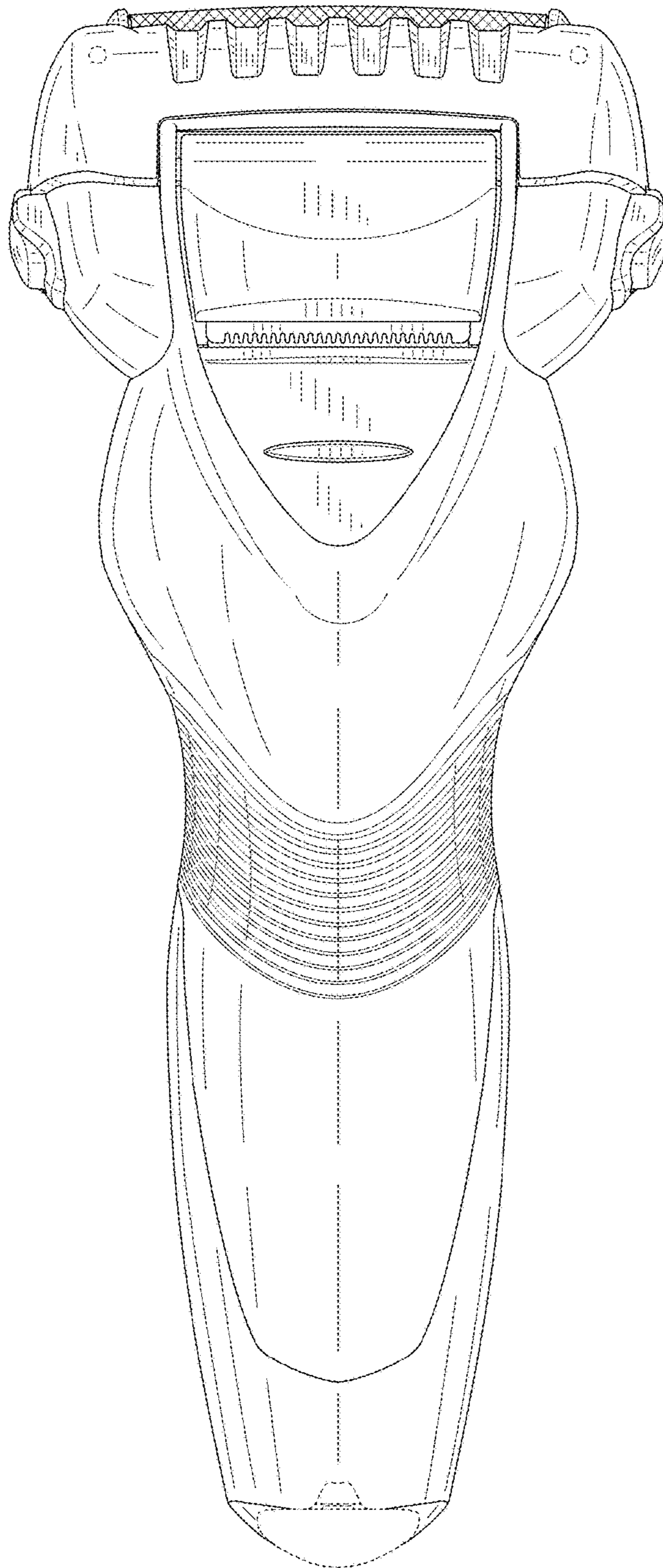

FIG. 5

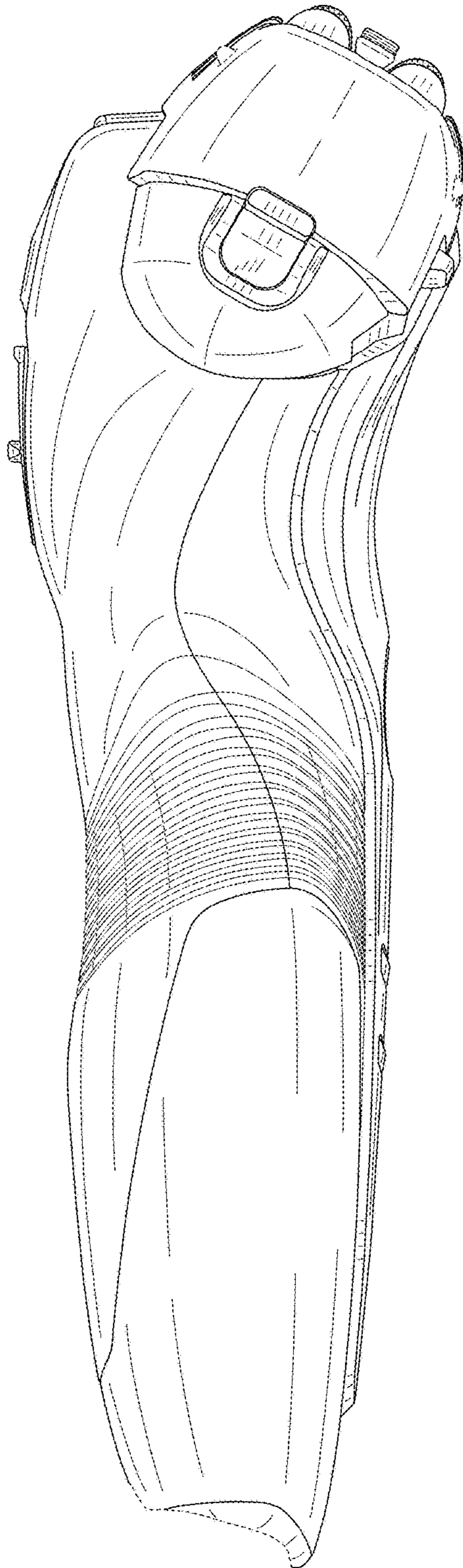

FIG. 6

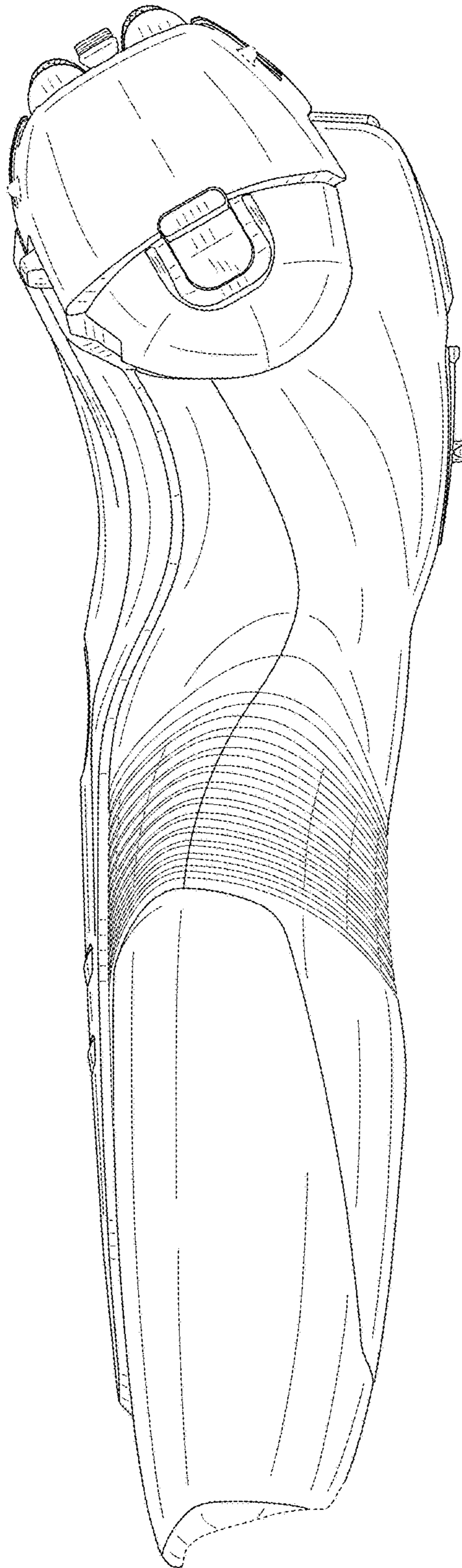



FIG. 7

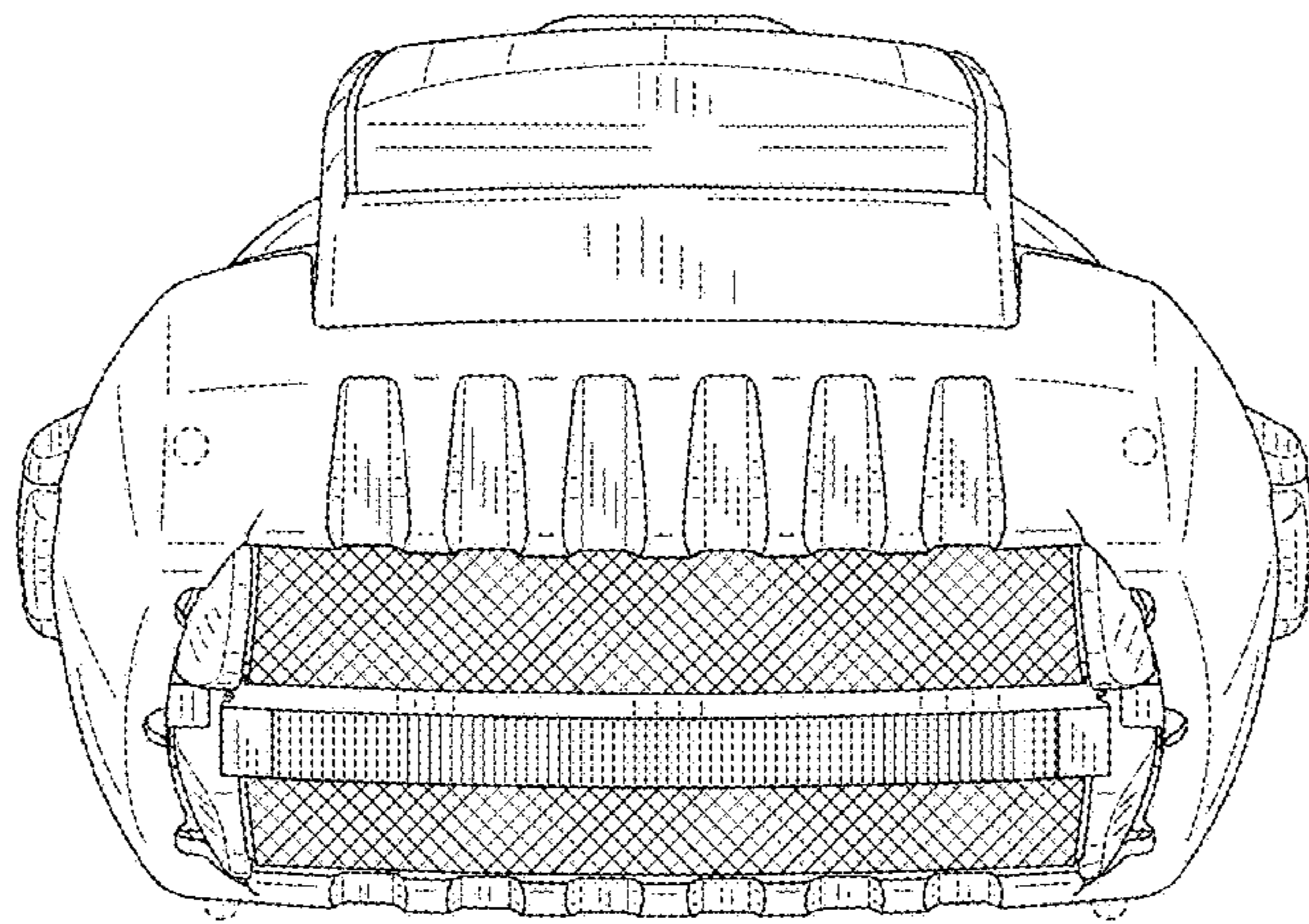



FIG. 8

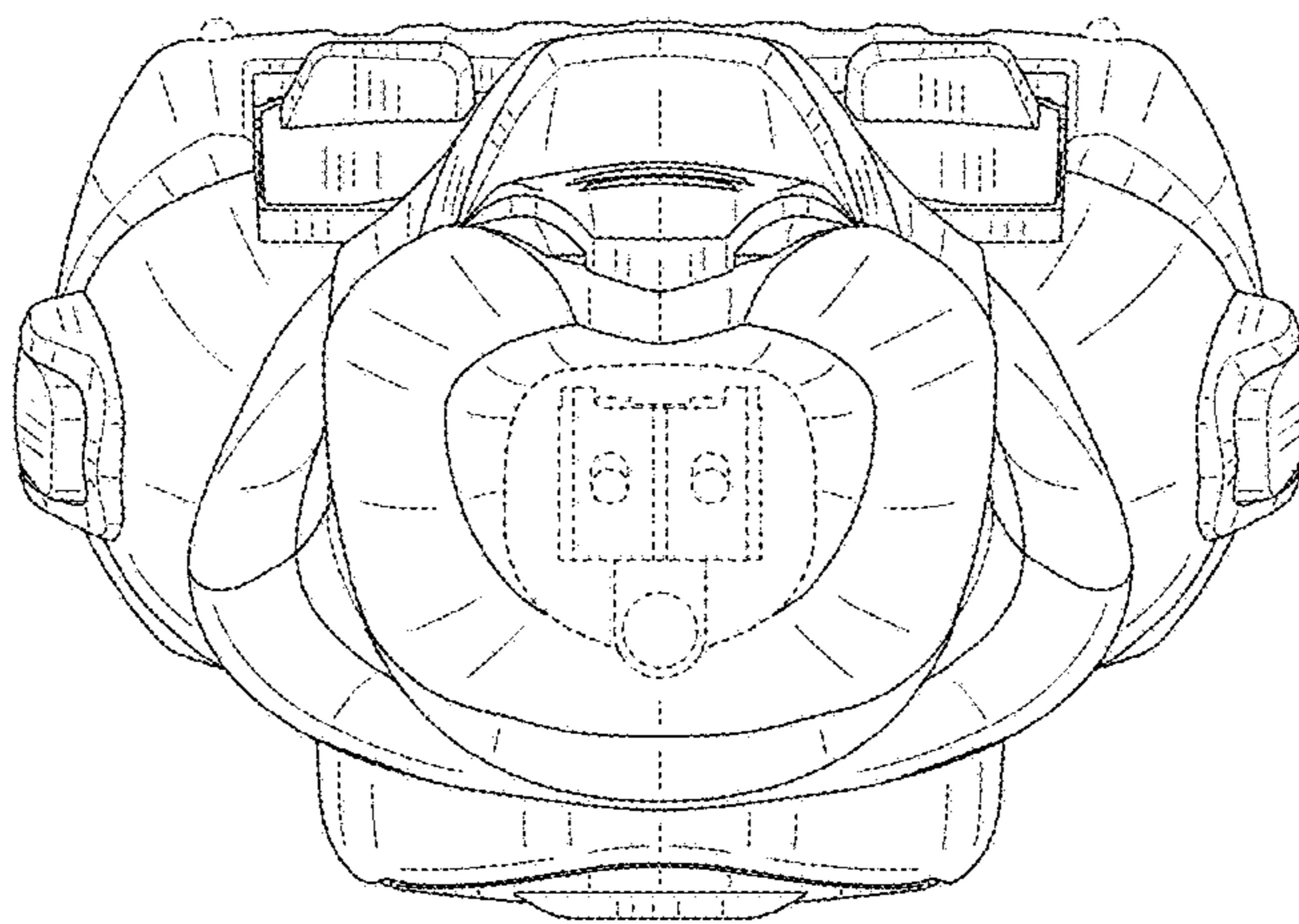

FIG. 9

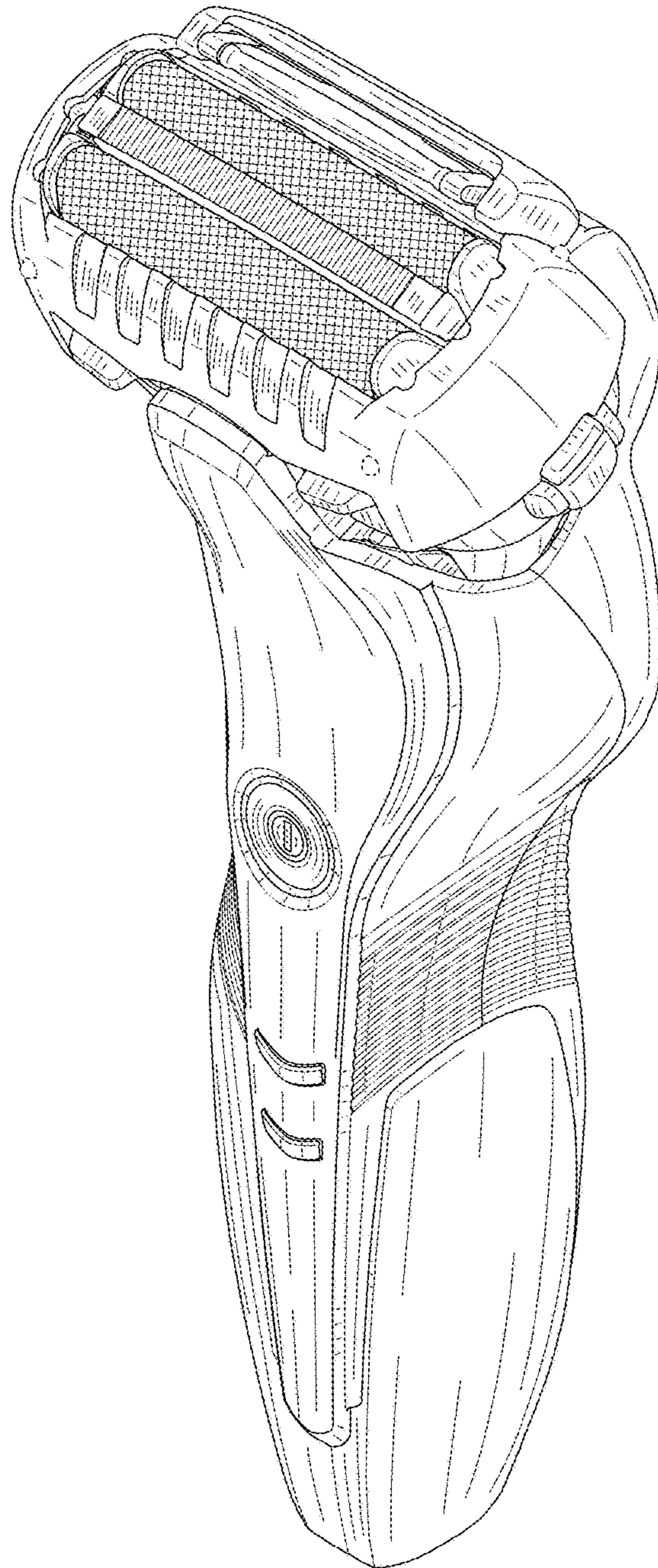

FIG. 10

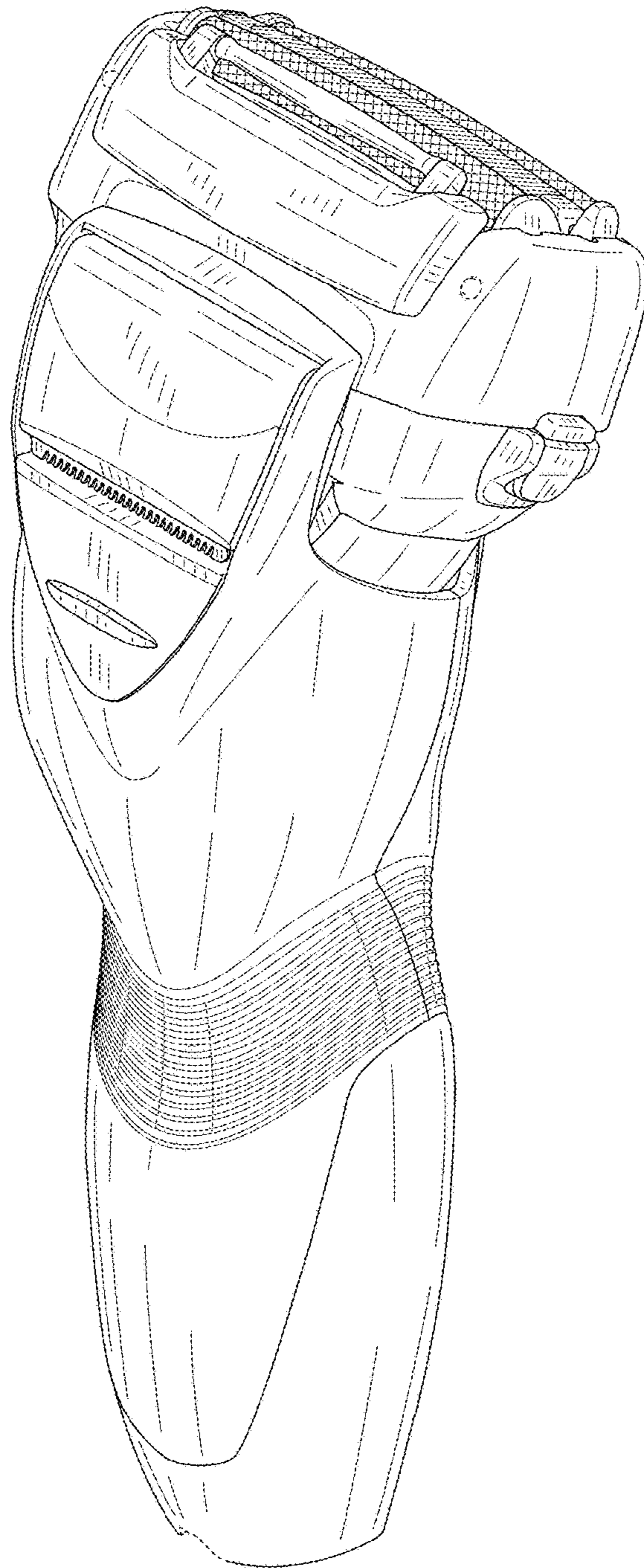



FIG. 11

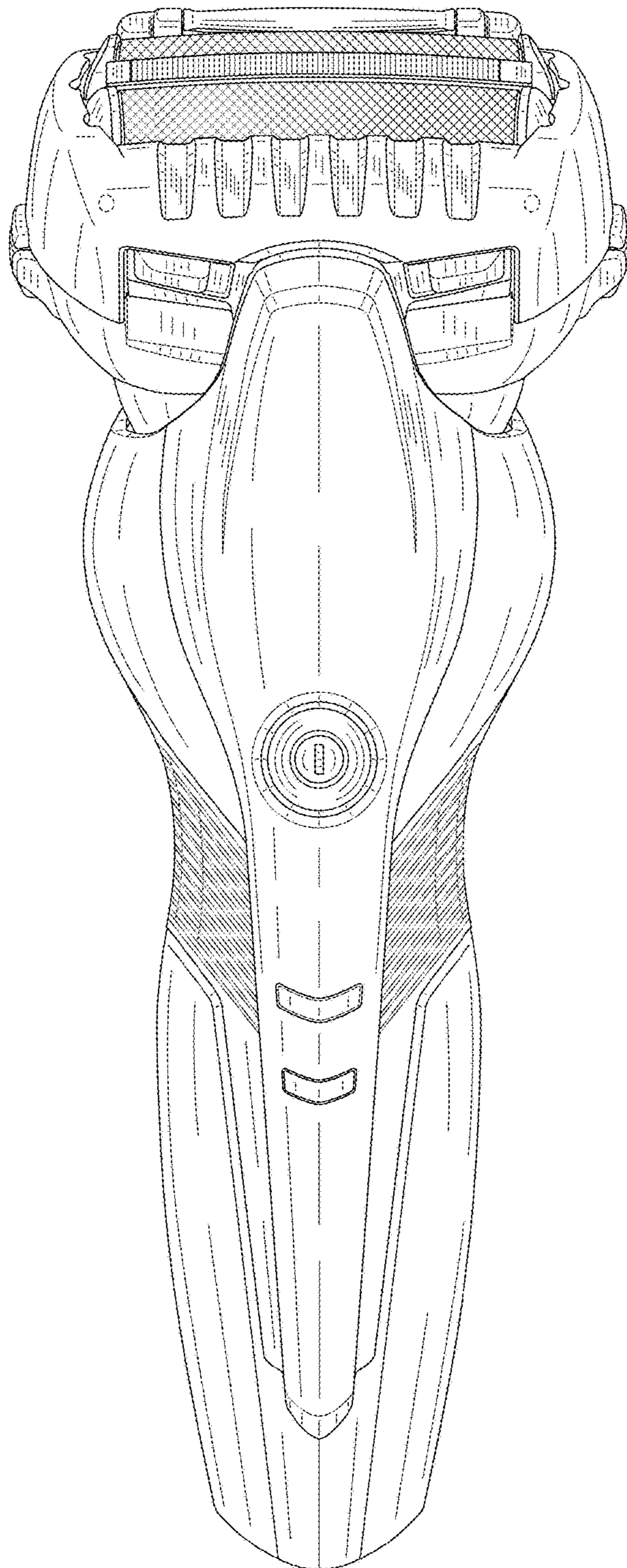

FIG. 12

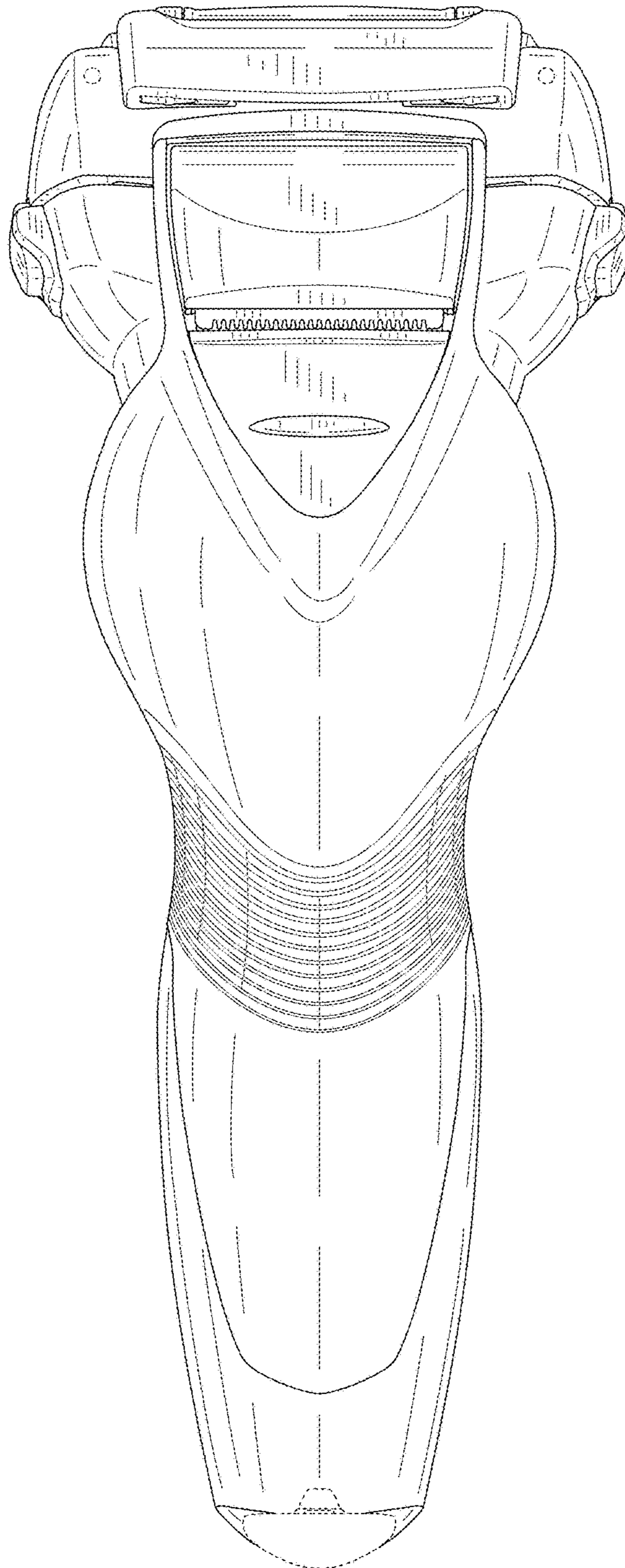

FIG. 13

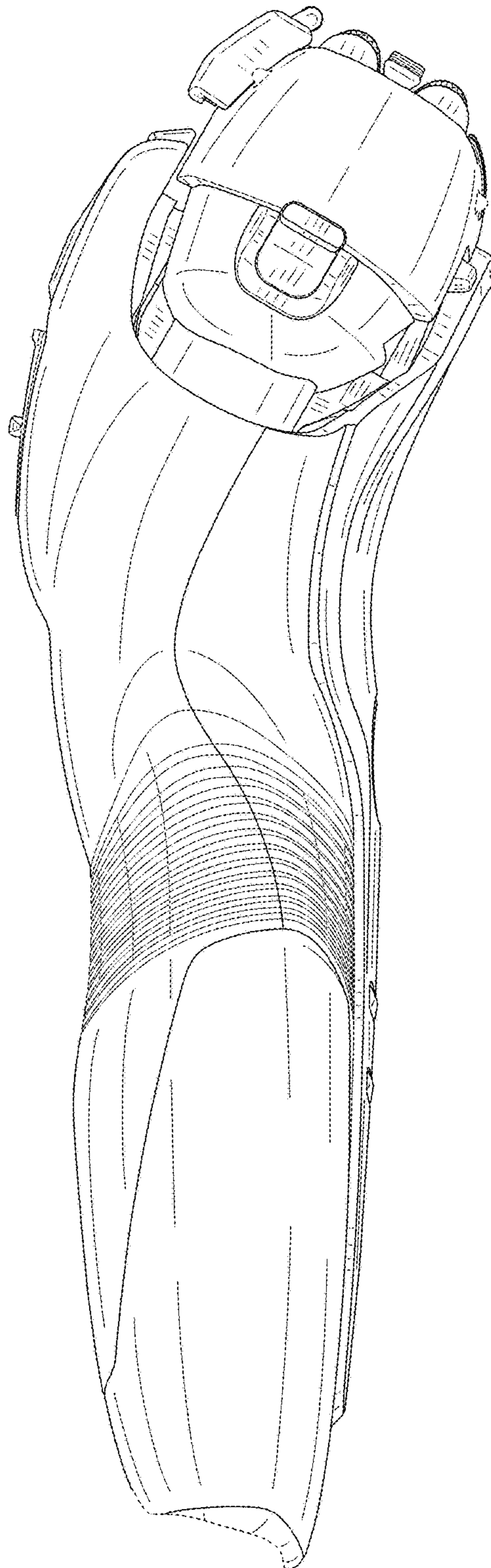



FIG. 14

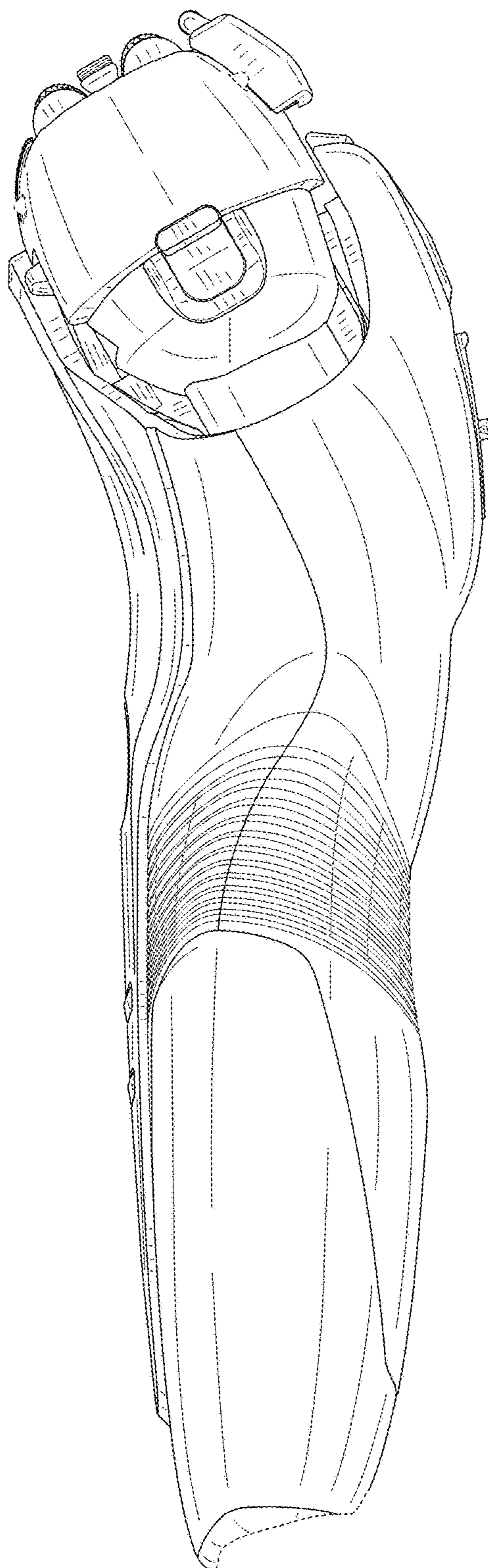

FIG. 15

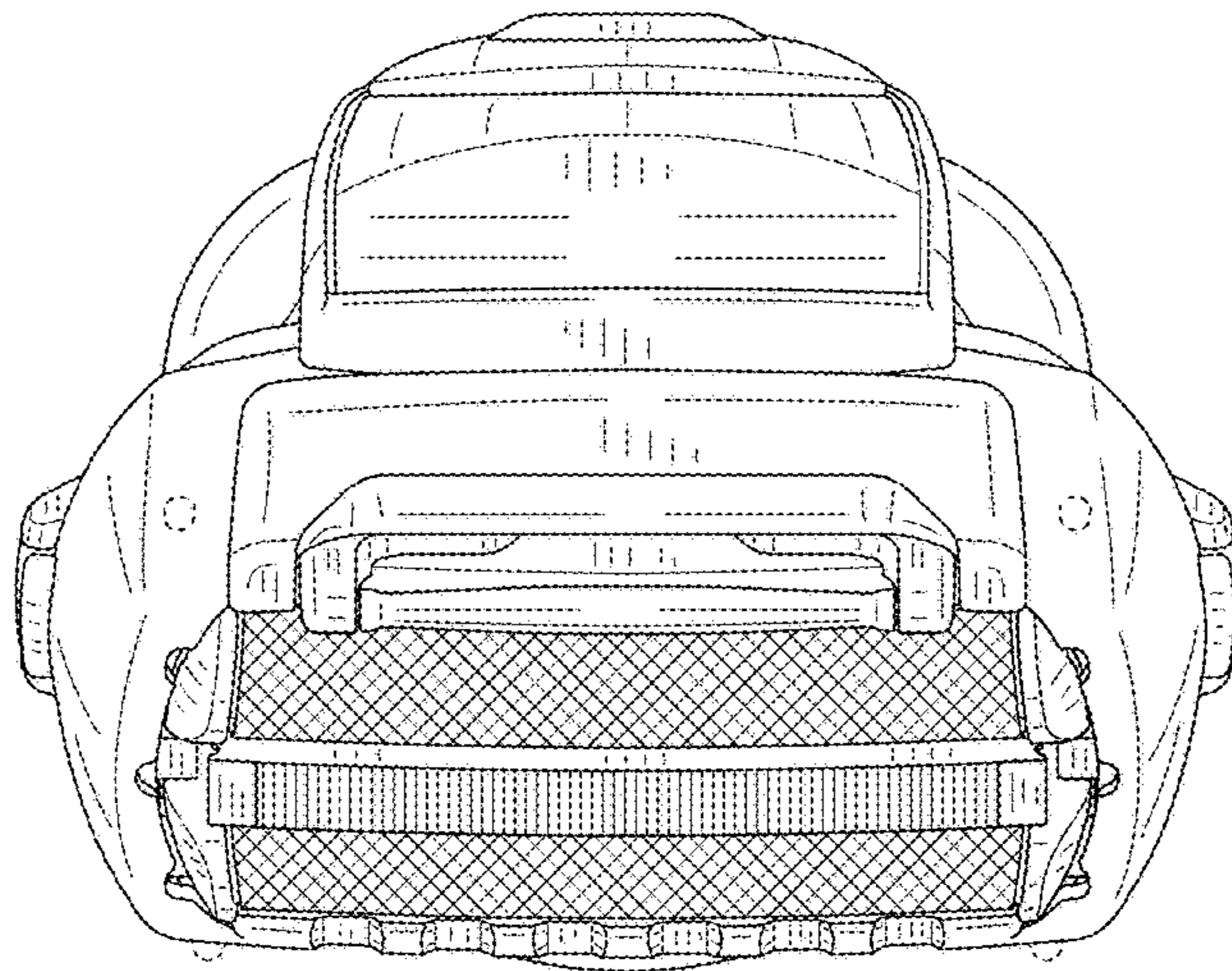

FIG. 16

