

US00D798798S

(12) **United States Design Patent** (10) **Patent No.:** **US D798,798 S**
Krusinski et al. (45) **Date of Patent:** **** Oct. 3, 2017**

(54) **CARGO HOLDER**

(71) Applicant: **HORIZON GLOBAL AMERICAS INC.**, Plymouth, MI (US)

(72) Inventors: **Scott Theodore Krusinski**, Hudson, OH (US); **Gail Suscheck Metcalfe**, Solon, OH (US); **Ashley Nicole Darrow**, Akron, OH (US)

(73) Assignee: **HORIZON GLOBAL AMERICAS INC.**, Plymouth, MI (US)

(**) Term: **15 Years**

(21) Appl. No.: **29/535,819**

(22) Filed: **Aug. 11, 2015**

(51) **LOC (10) Cl.** **12-16**

(52) **U.S. Cl.**
USPC **D12/413**

(58) **Field of Classification Search**
USPC ... D12/414.1, 414, 413, 412, 221, 406, 157,
D12/423; D6/552, 317-319, 513-514;
D3/304-306; D32/35, 58
CPC B60R 7/02; B60R 9/04; B60R 9/055
See application file for complete search history.

(56) **References Cited**

U.S. PATENT DOCUMENTS

D656,082 S	*	3/2012	Gruner	D12/413
D717,228 S	*	11/2014	Sagen	D12/413
D717,719 S	*	11/2014	Sagen	D12/413
D722,006 S	*	2/2015	Settelmayer	D12/413
D724,520 S	*	3/2015	Gruner	D12/413
D726,638 S	*	4/2015	Rupp	D12/413
D739,336 S	*	9/2015	Berrey	D12/413
D773,378 S	*	12/2016	Sagen	D12/413
D773,379 S	*	12/2016	Toyoshima	D12/413
D774,442 S	*	12/2016	Adler	D12/413

OTHER PUBLICATIONS

Thule Interstate 869 available at <http://www.thule.com/en-us/us/products/carriers-and-racks/boxes-and-baskets/cargo-bags/thule-interstate-869--1683516> (last accessed Feb. 10, 2016).

* cited by examiner

Primary Examiner — Katrina A Betton

(74) *Attorney, Agent, or Firm* — McDonald Hopkins LLC

(57) **CLAIM**

The ornamental design for a cargo holder, as shown and described.

DESCRIPTION

FIG. 1 is a front perspective view of a cargo holder showing our new design;
FIG. 2 is a rear perspective view thereof;
FIG. 3 is a front view thereof;
FIG. 4 is a rear view thereof;
FIG. 5 is a side view thereof;
FIG. 6 is a top view thereof;
FIG. 7 is a bottom view thereof;
FIG. 8 is a perspective view of a second embodiment of a cargo holder showing our new design;
FIG. 9 is a rear perspective view thereof;
FIG. 10 is a front view thereof;
FIG. 11 is a rear view thereof;
FIG. 12 is a side view thereof;
FIG. 13 is a top view thereof;
FIG. 14 is a bottom view thereof;
FIG. 15 is a perspective view of a third embodiment of a cargo holder showing our new design;
FIG. 16 is a rear perspective view thereof;
FIG. 17 is a front view thereof;
FIG. 18 is a rear view thereof;
FIG. 19 is a side view thereof;
FIG. 20 is a top view thereof; and,
FIG. 21 is a bottom view thereof.
The broken lines in the figures are included for the purpose of illustrating portions of a cargo holder and form no part of the claimed design.

1 Claim, 18 Drawing Sheets

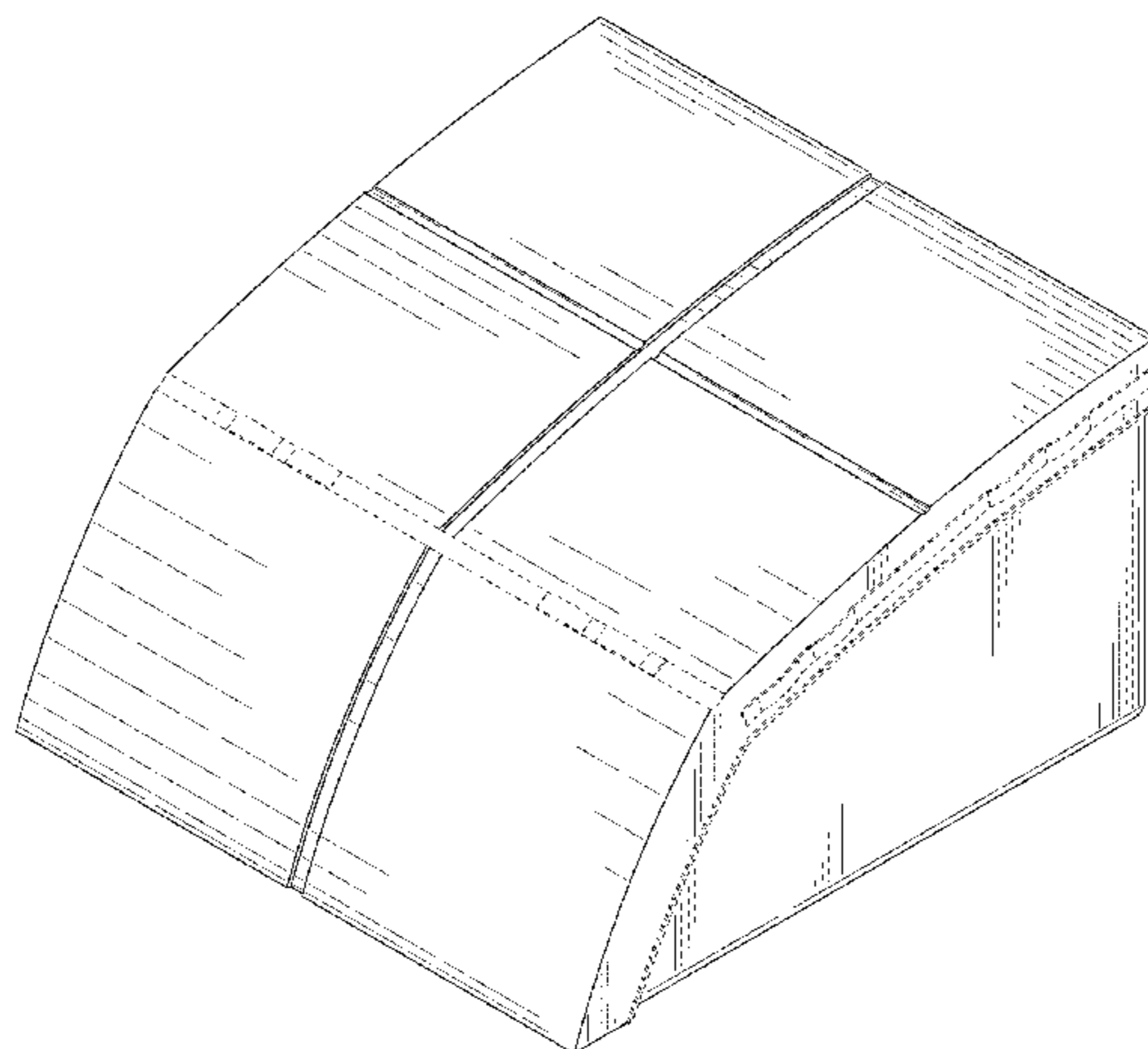

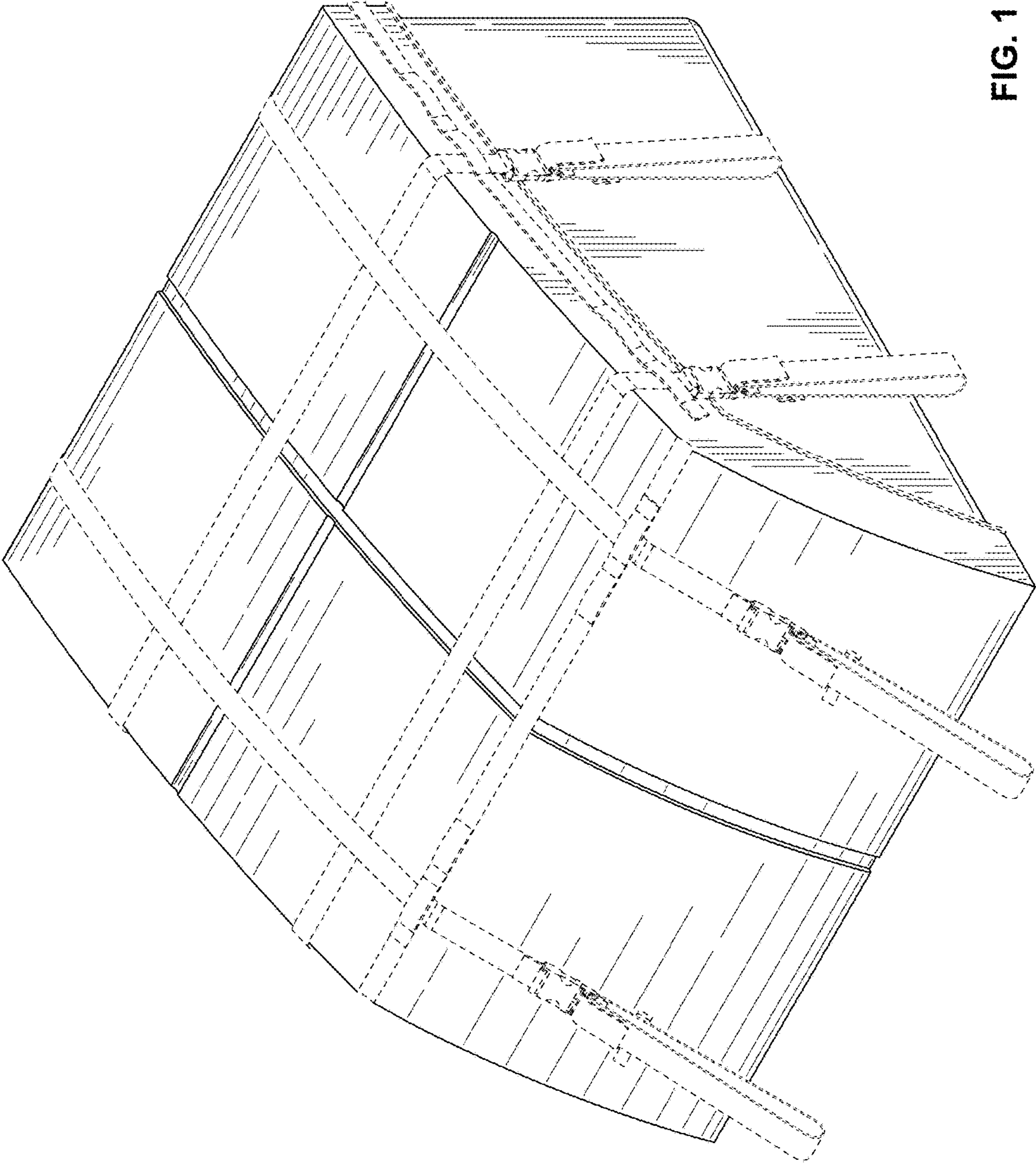

FIG. 1

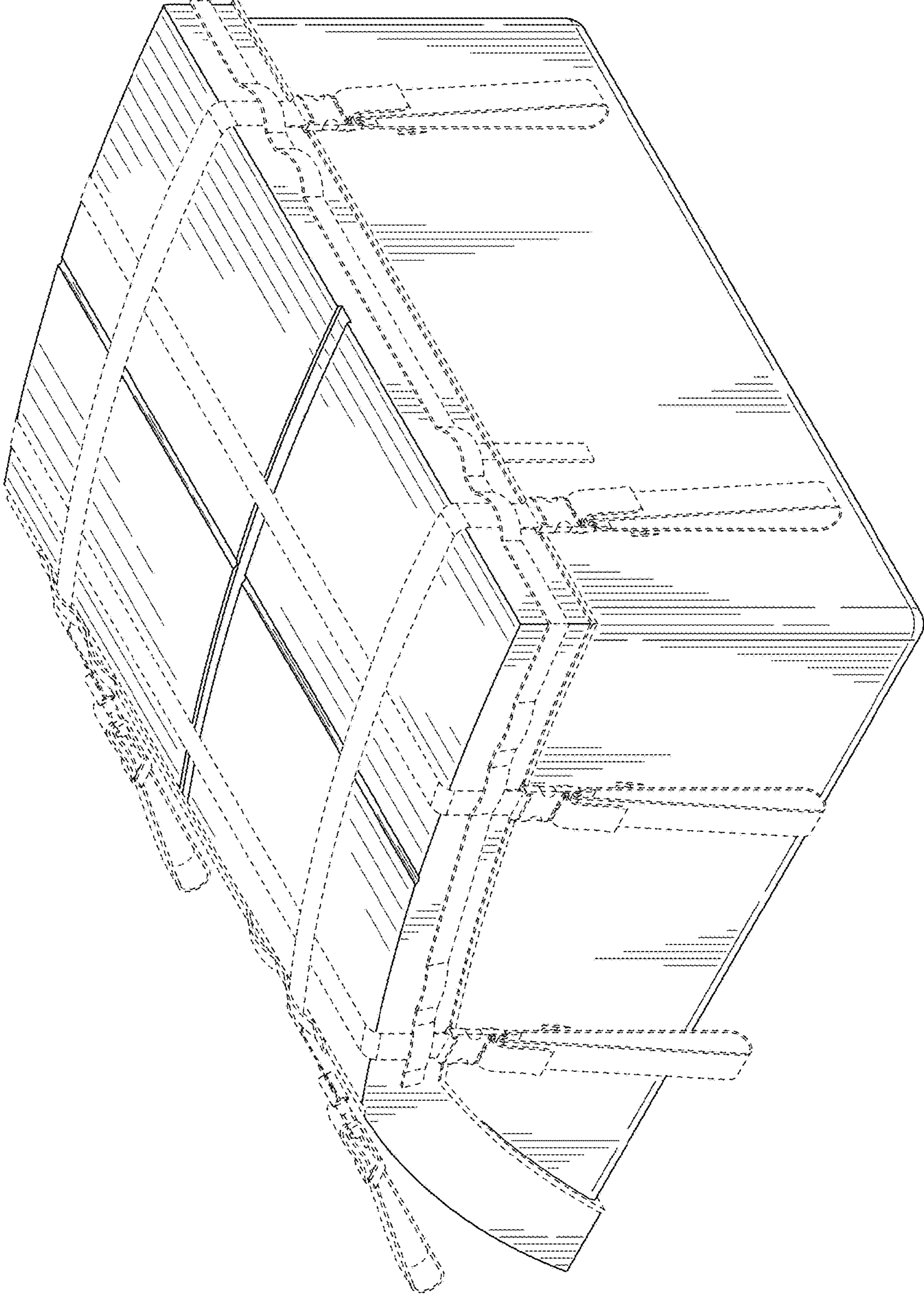

FIG. 2

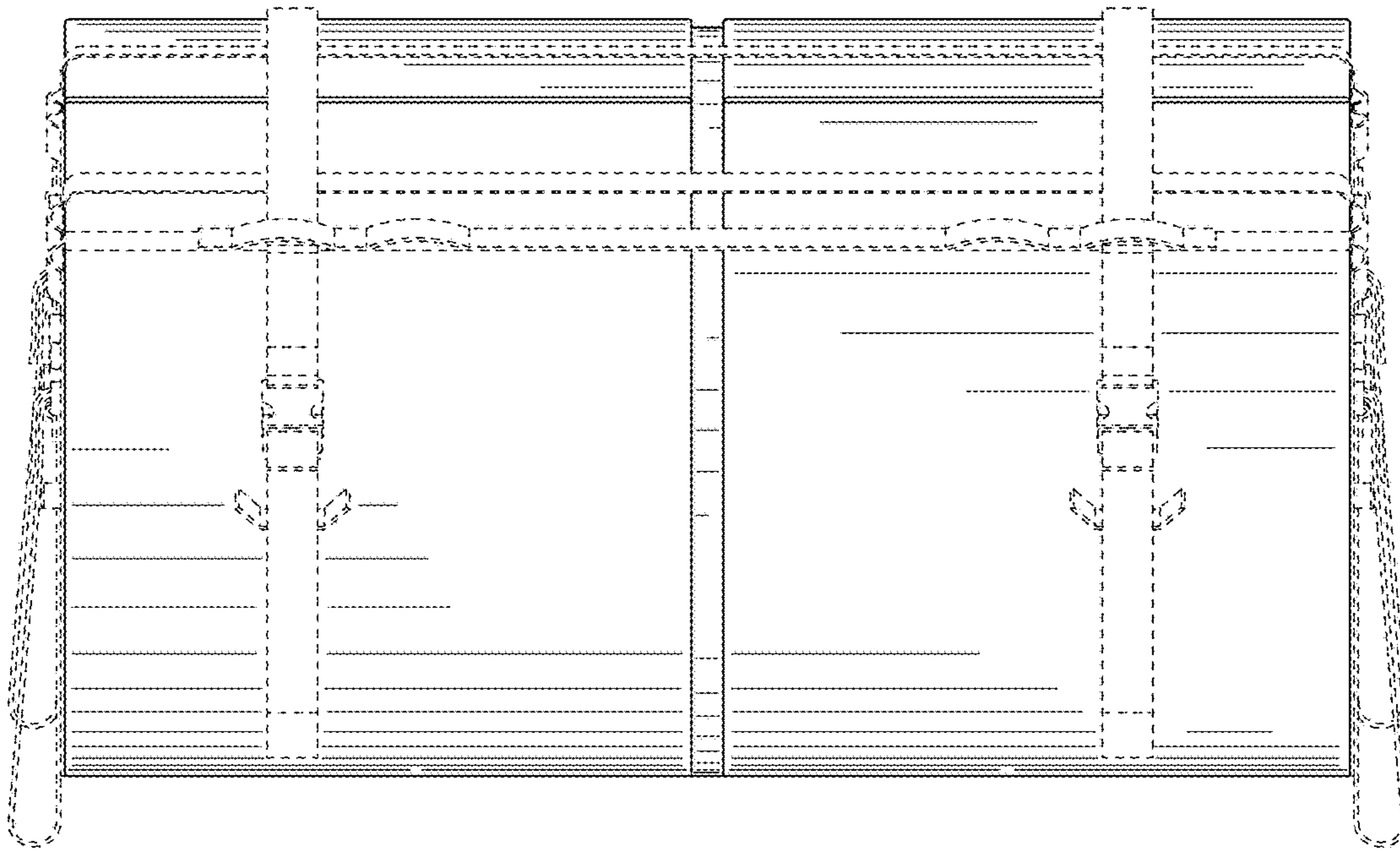

FIG. 3

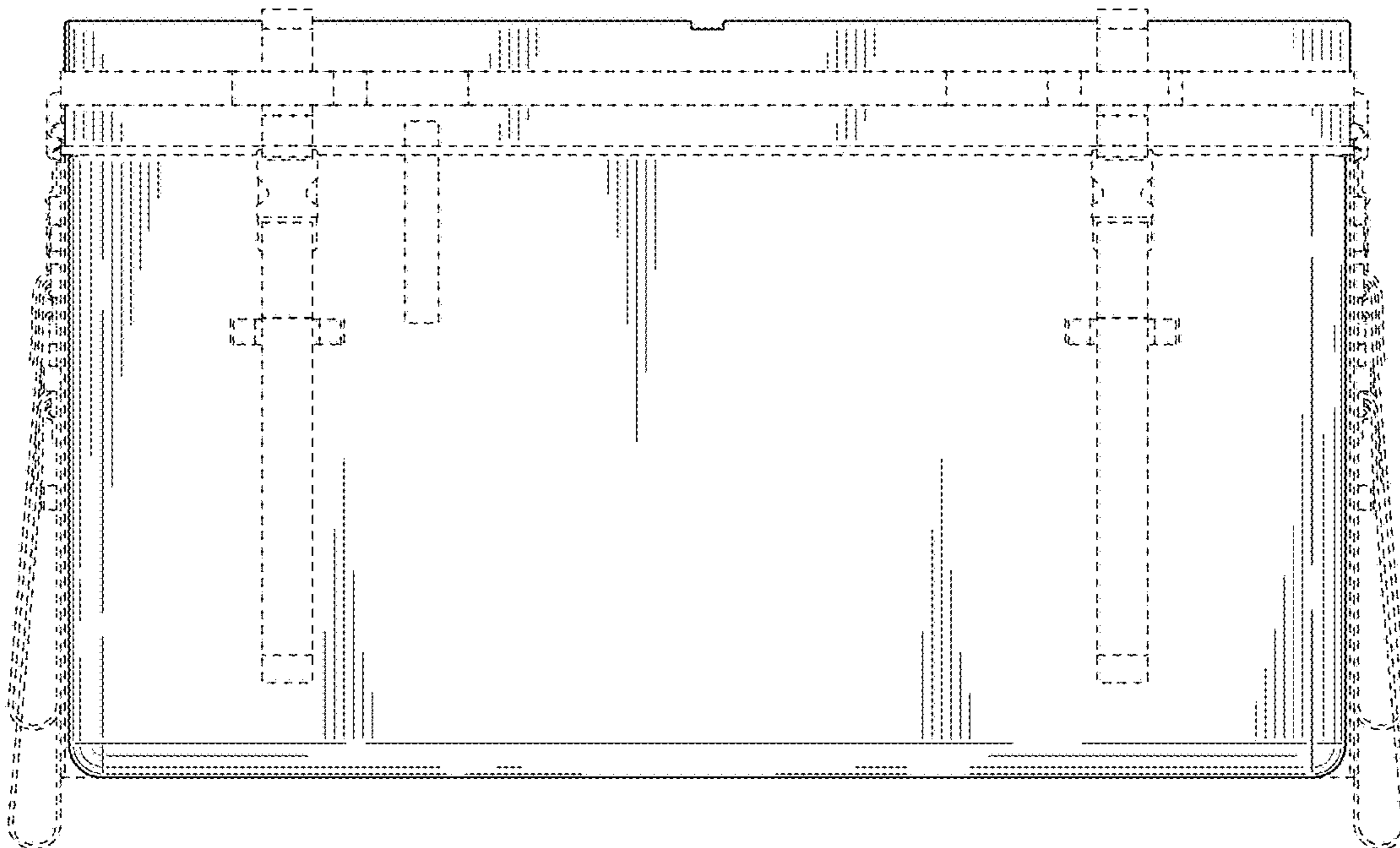

FIG. 4

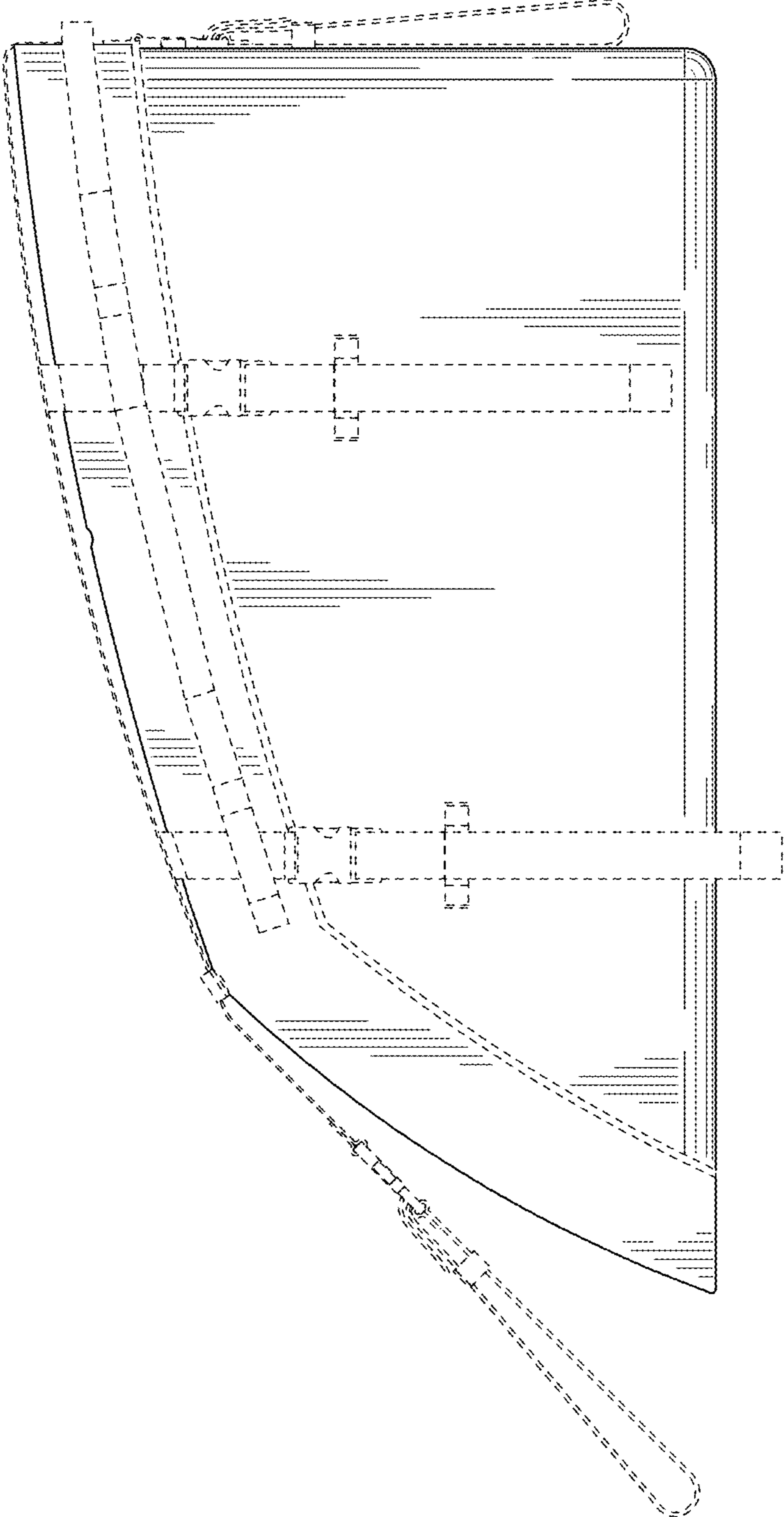

FIG. 5

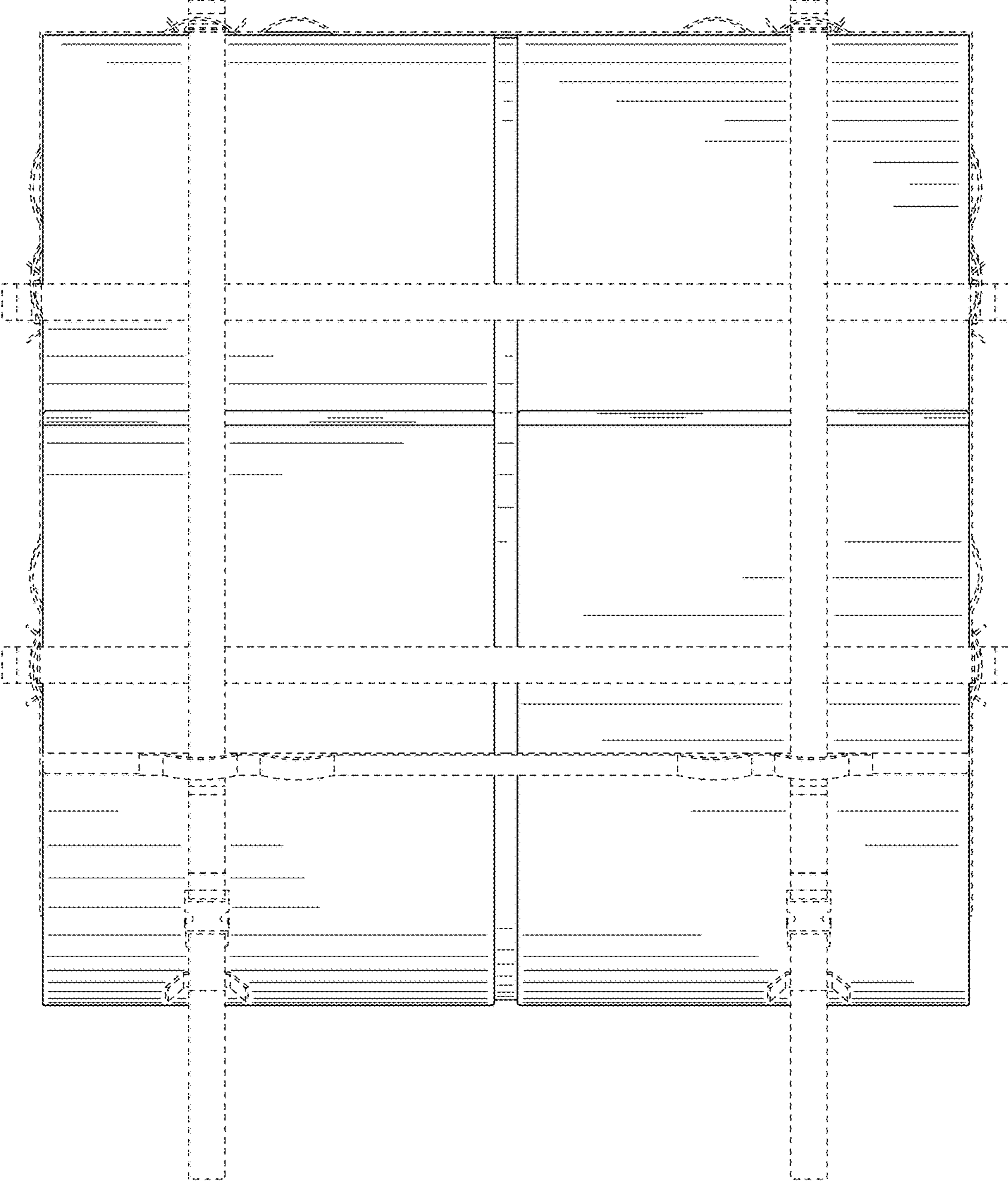

FIG. 6

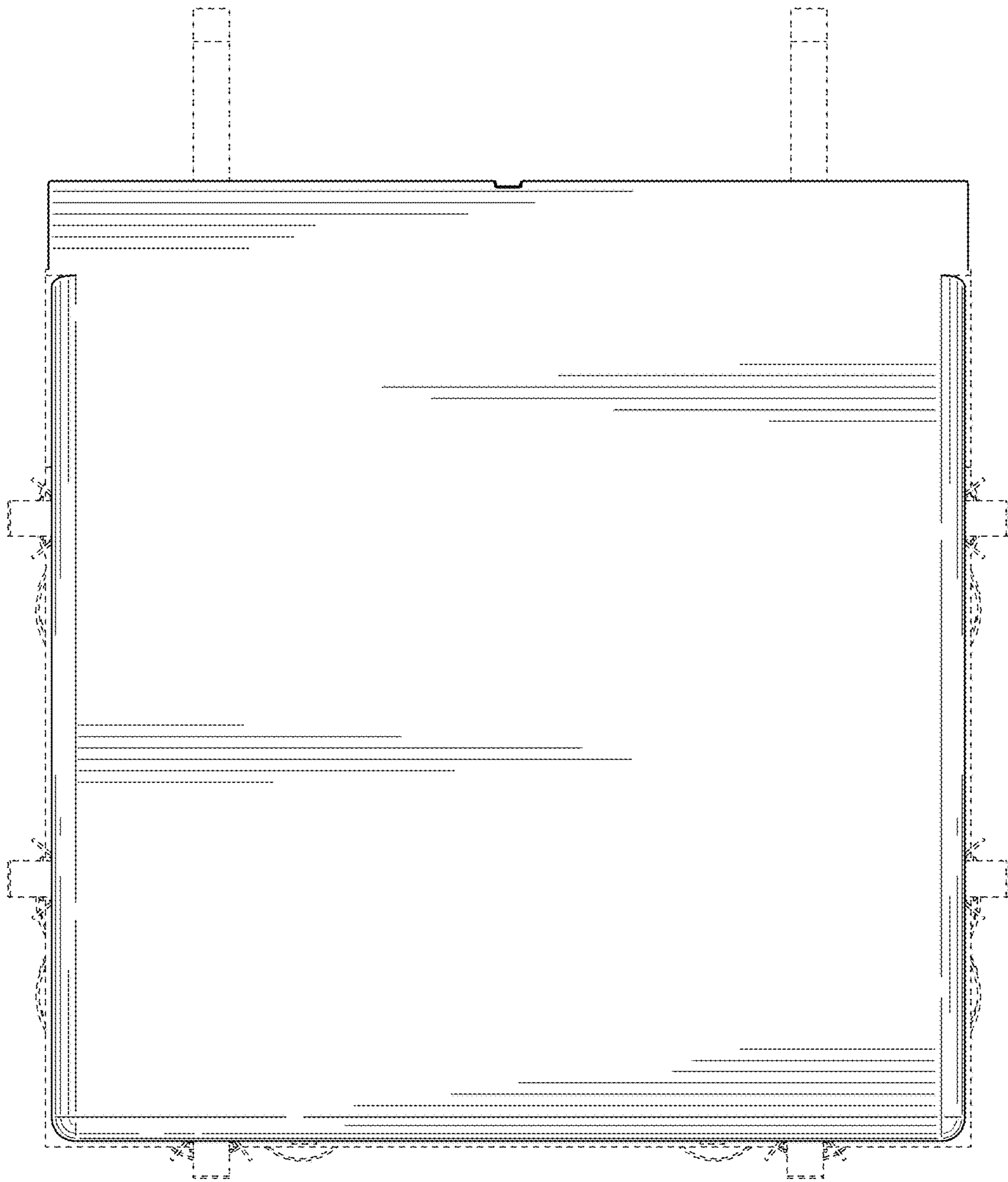

FIG. 7

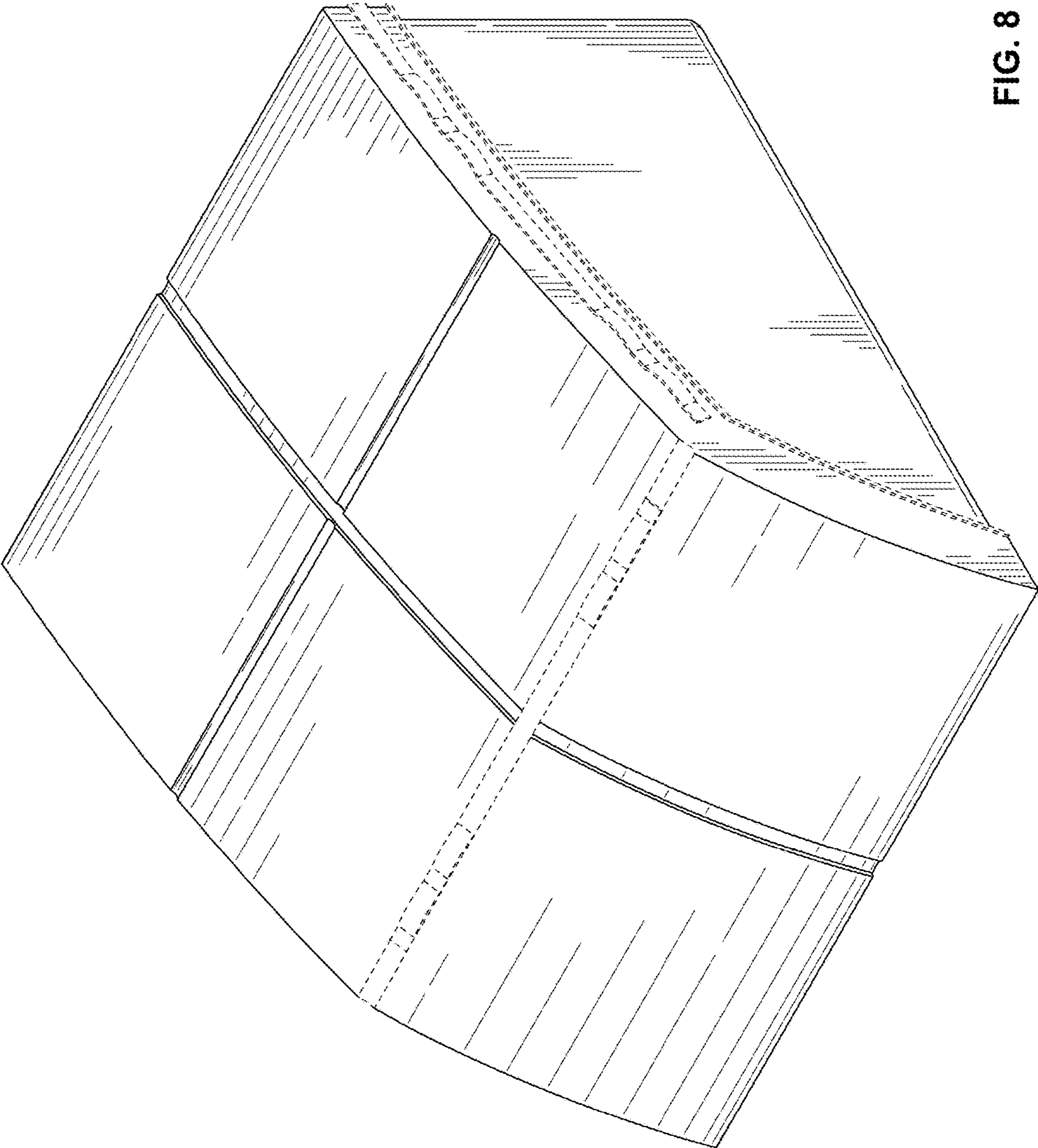

FIG. 8

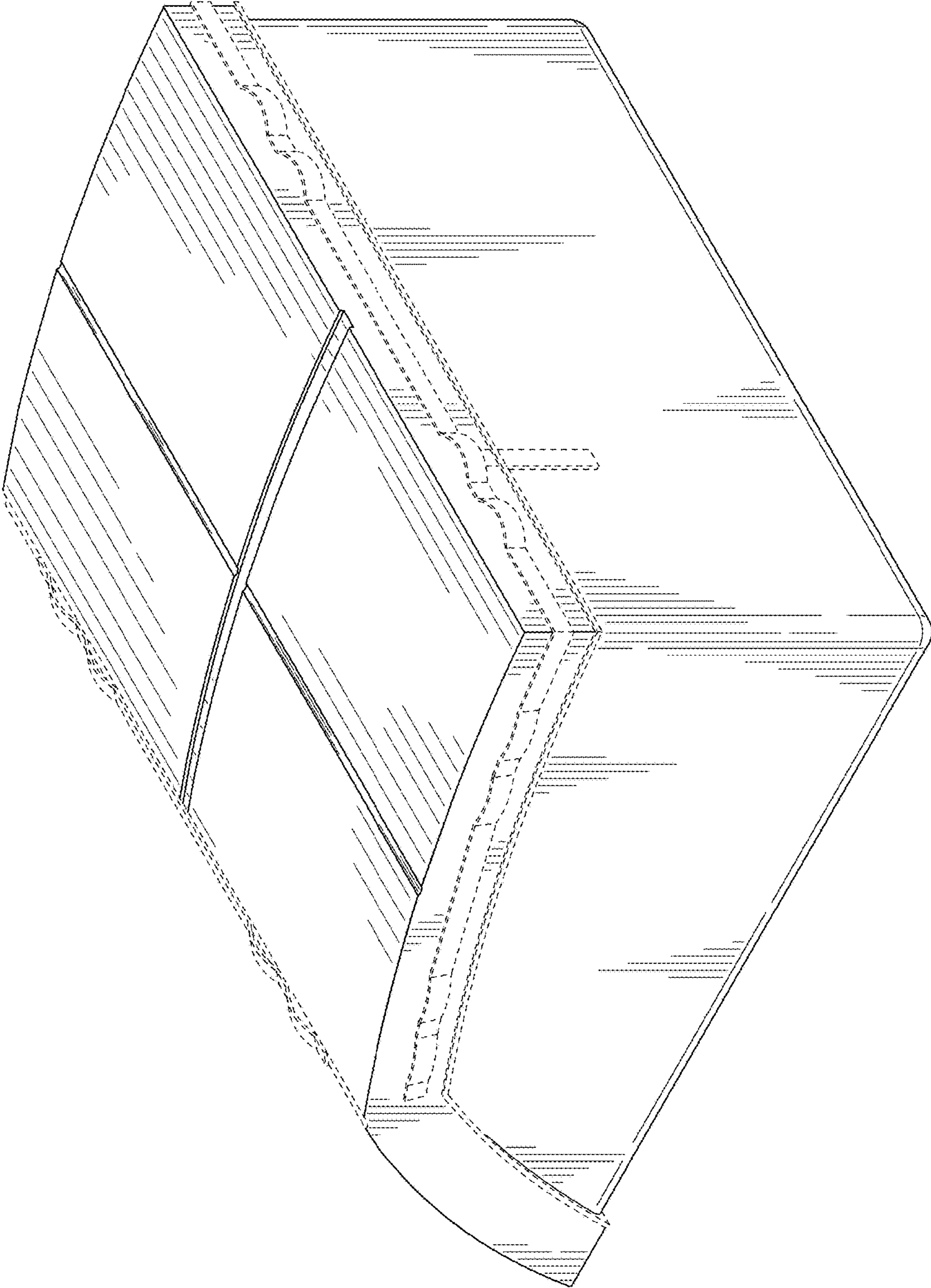

FIG. 9

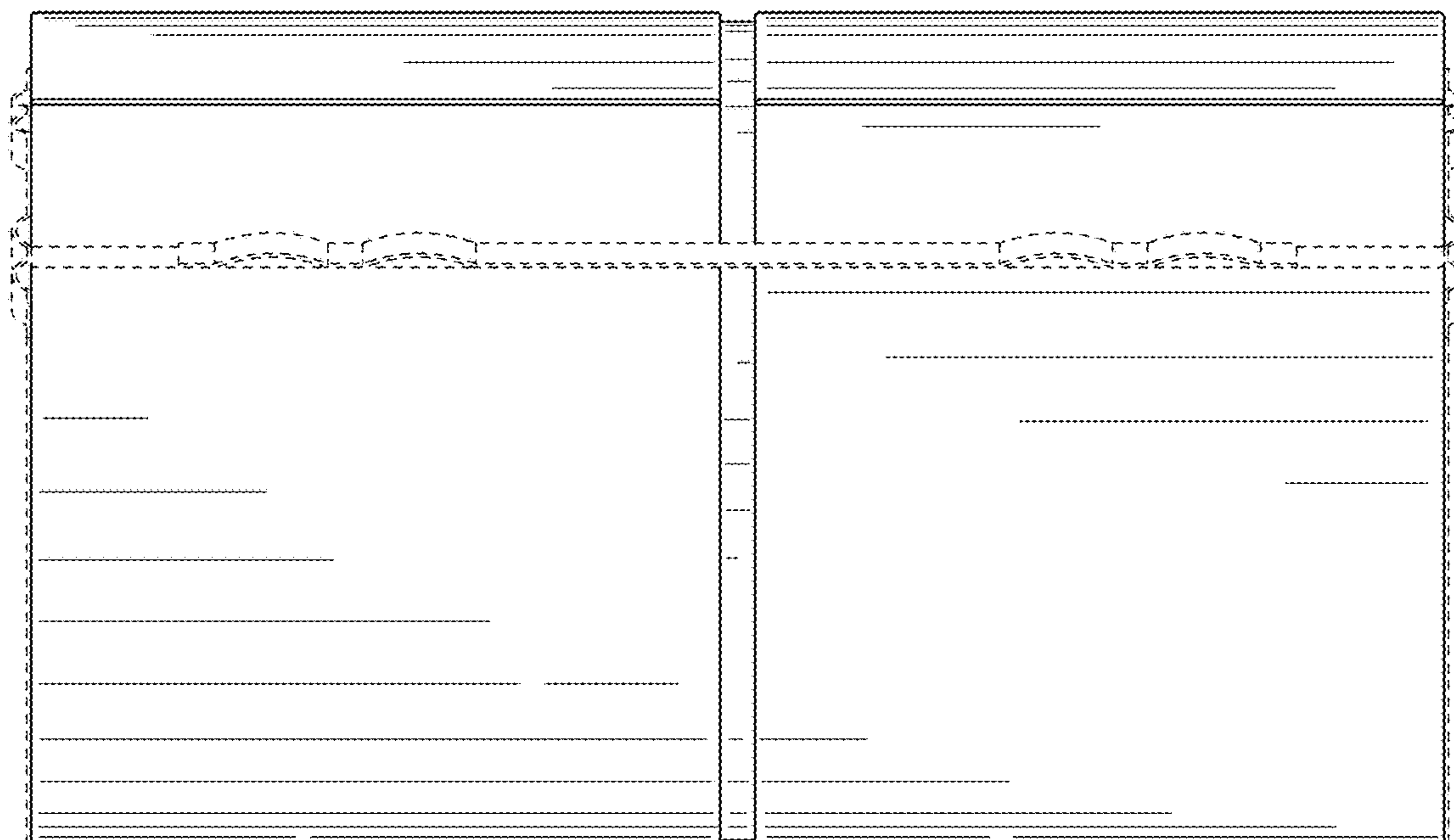

FIG. 10

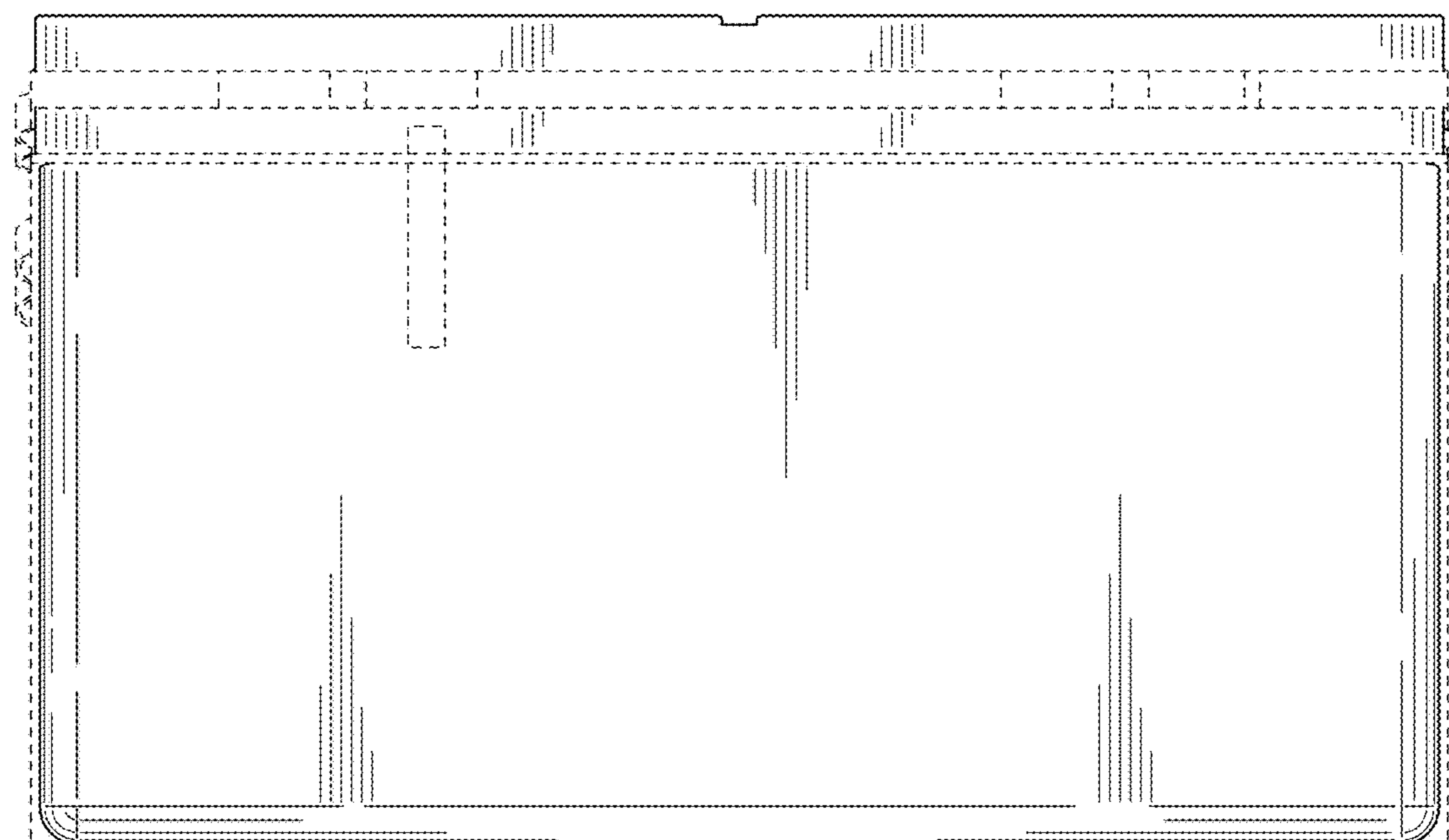

FIG. 11

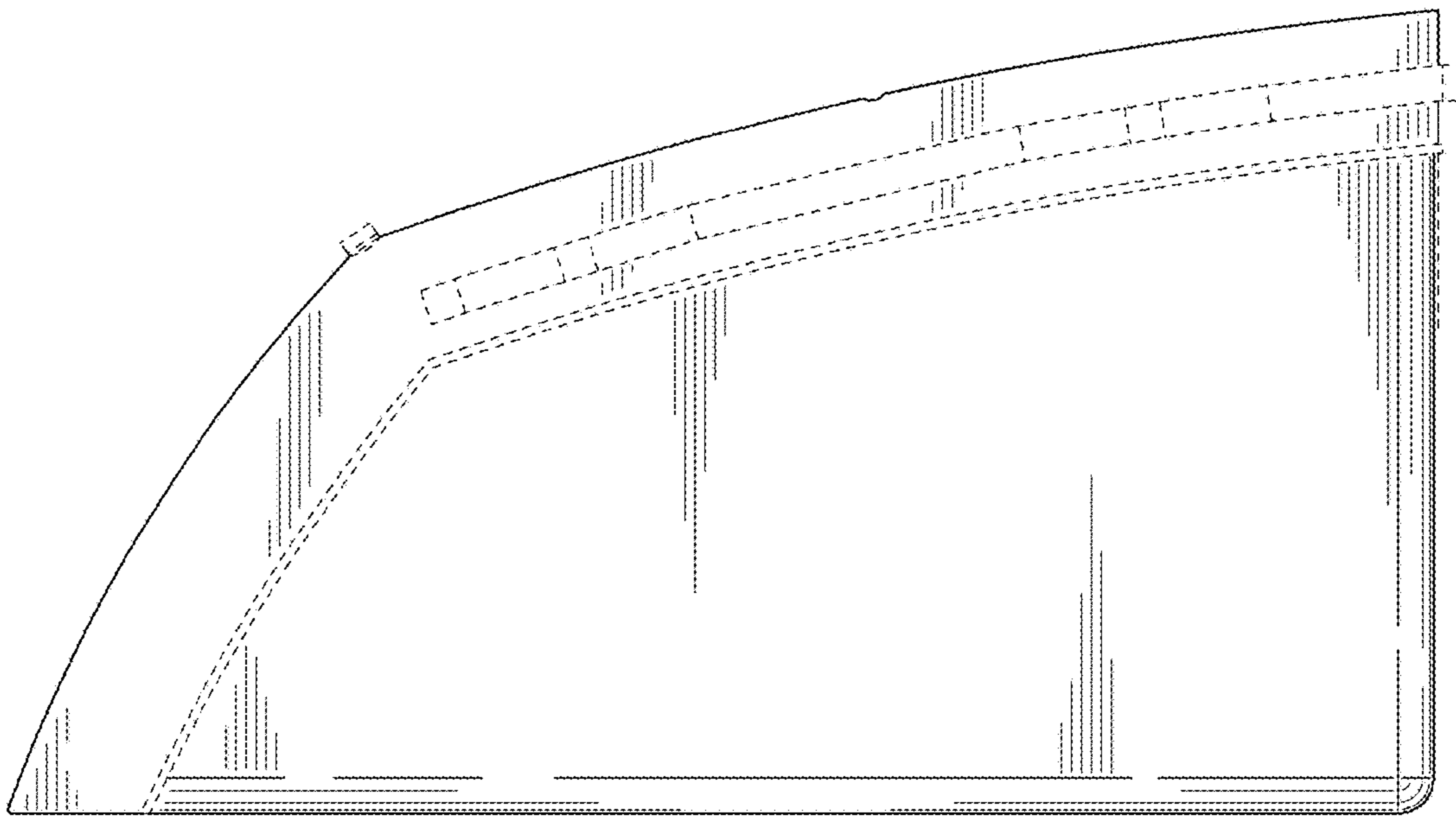

FIG. 12

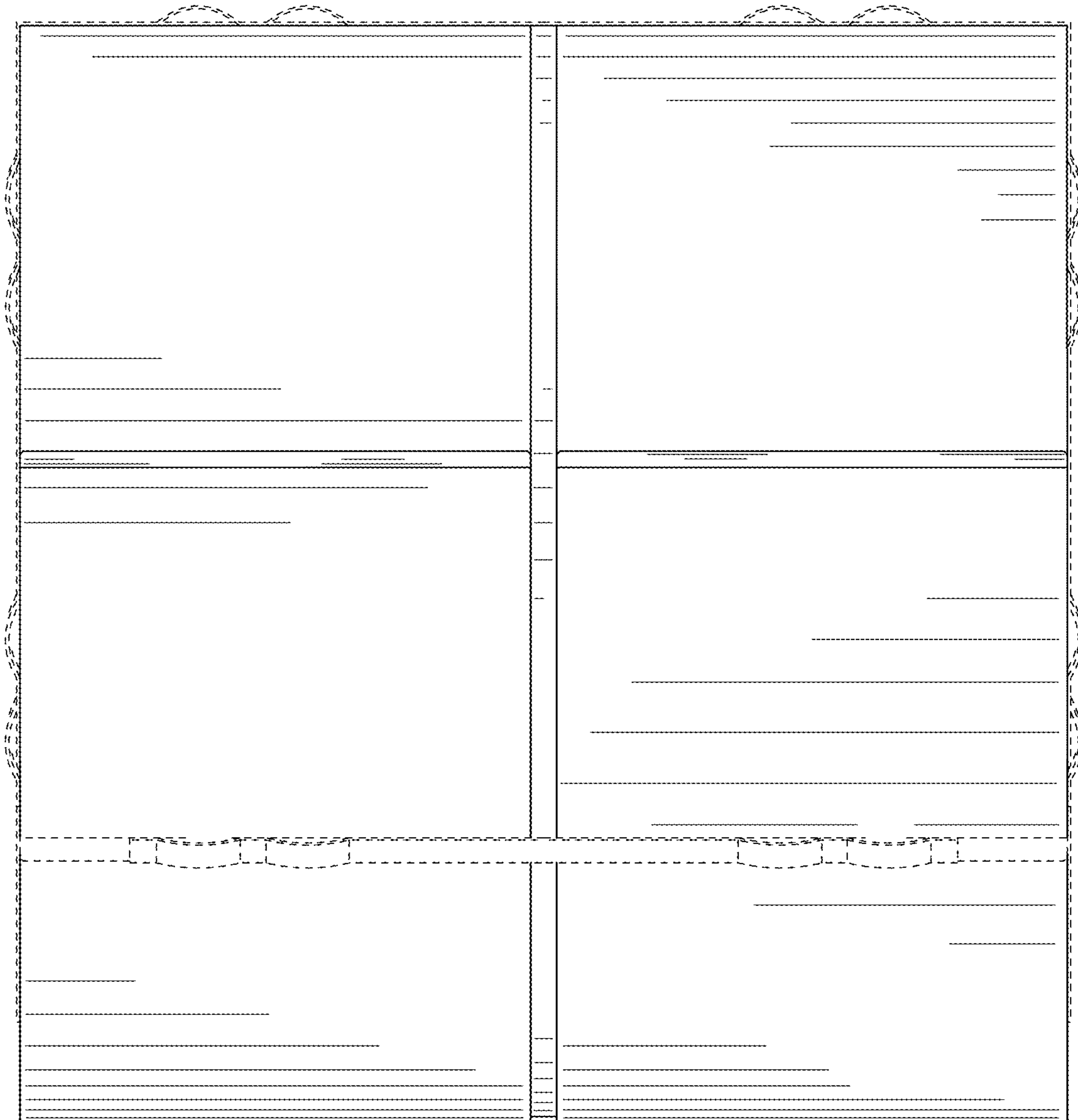

FIG. 13

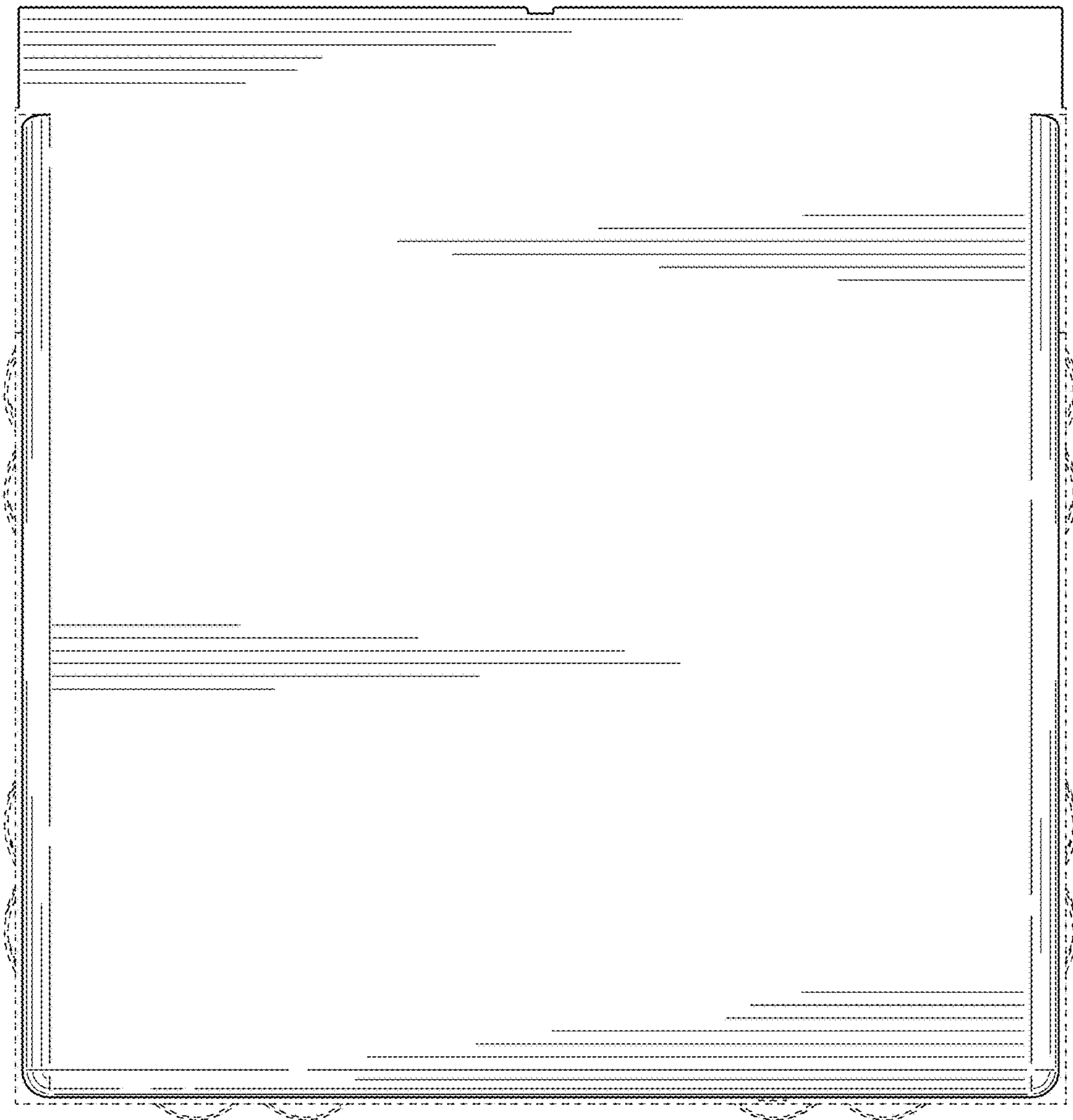

FIG. 14

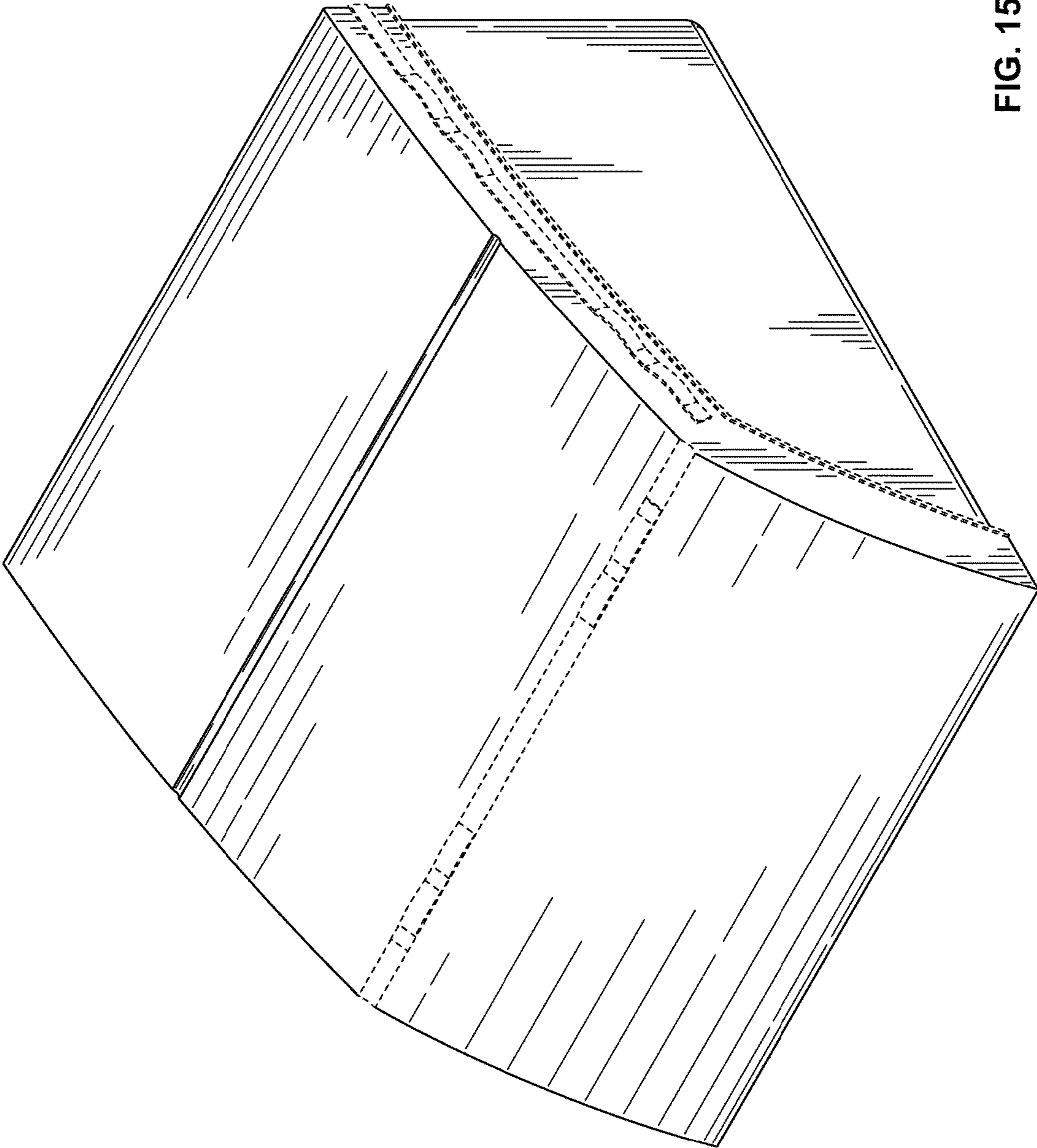

FIG. 15

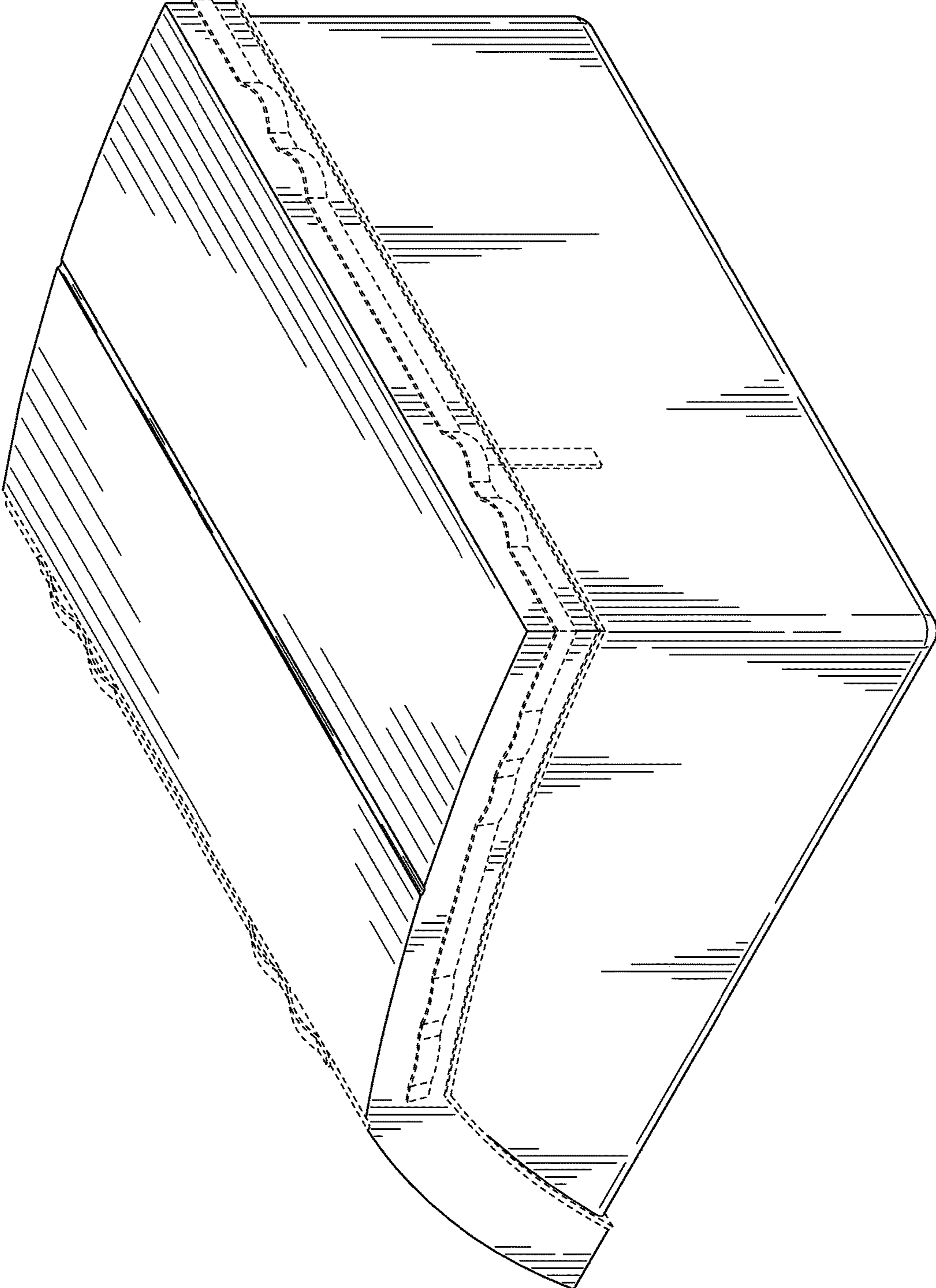

FIG. 16

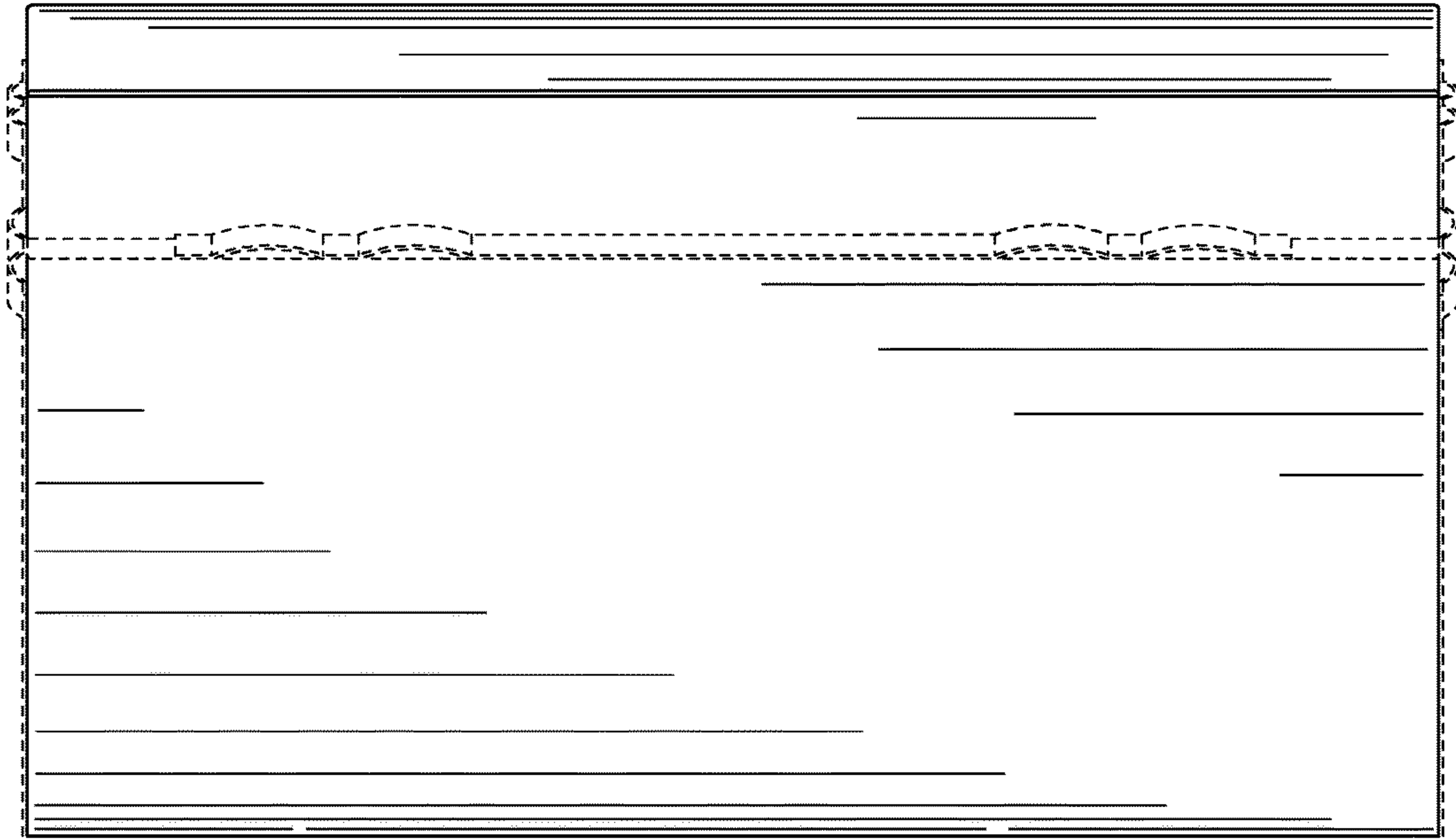

FIG. 17

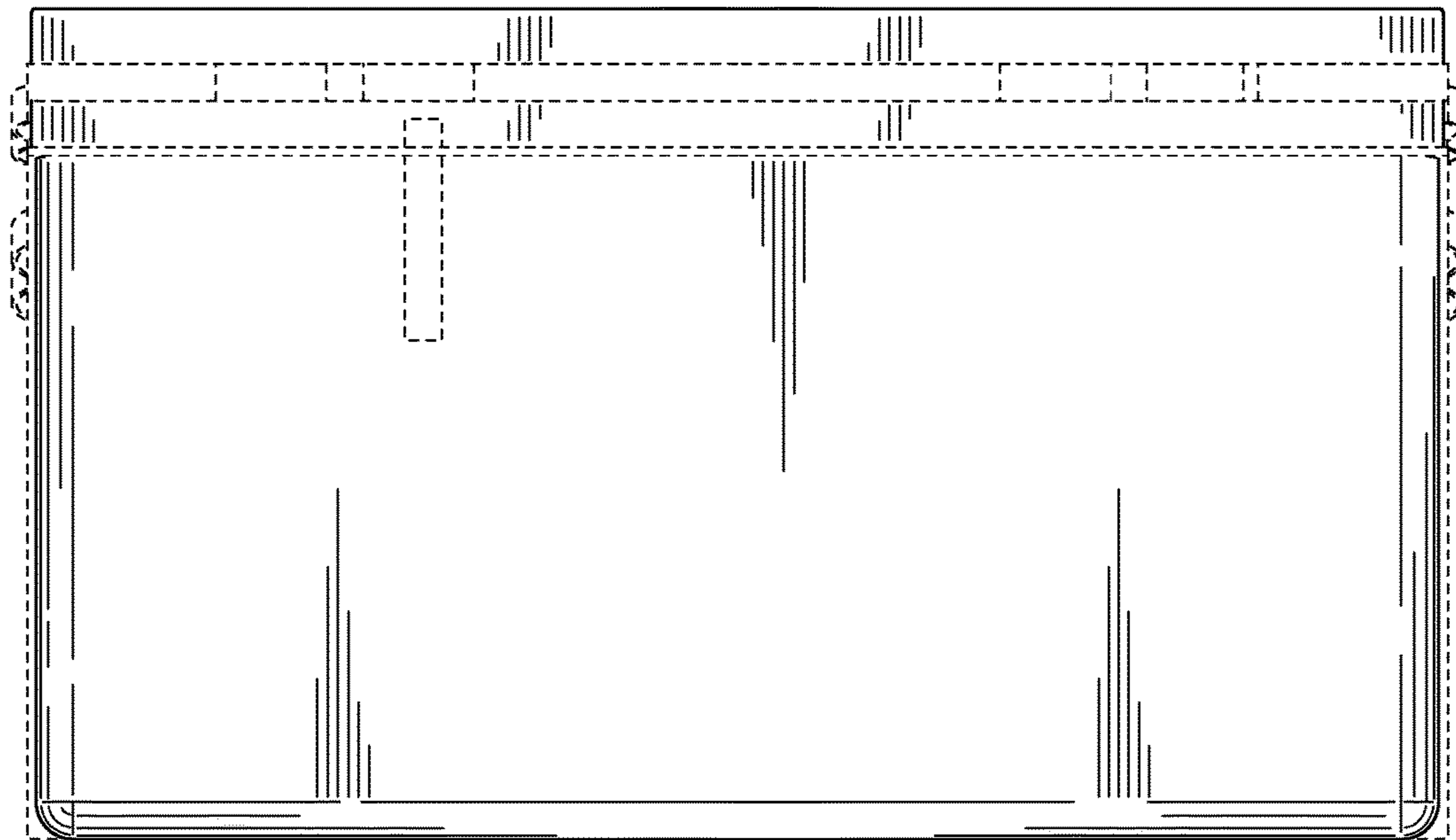

FIG. 18

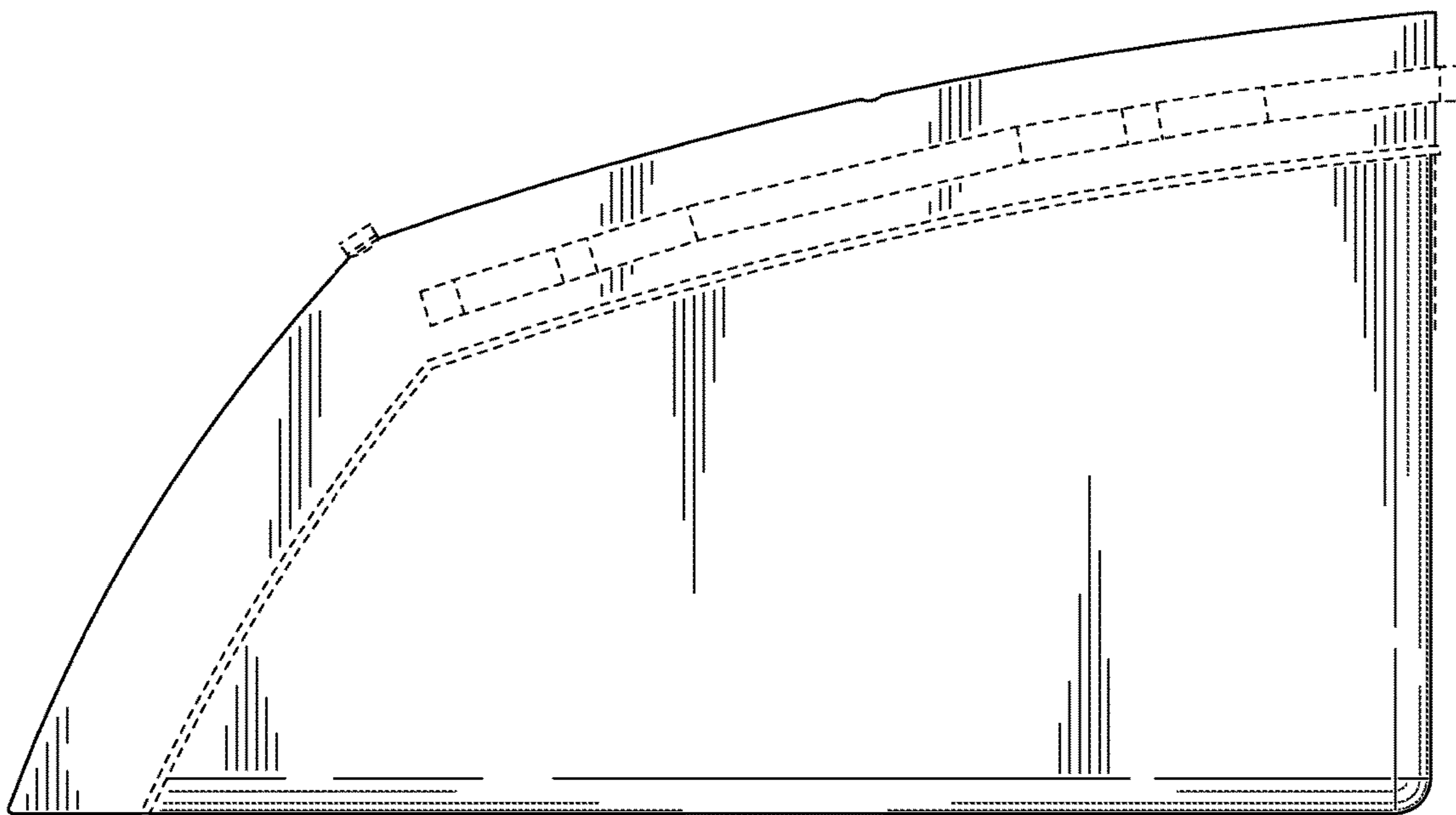

FIG. 19

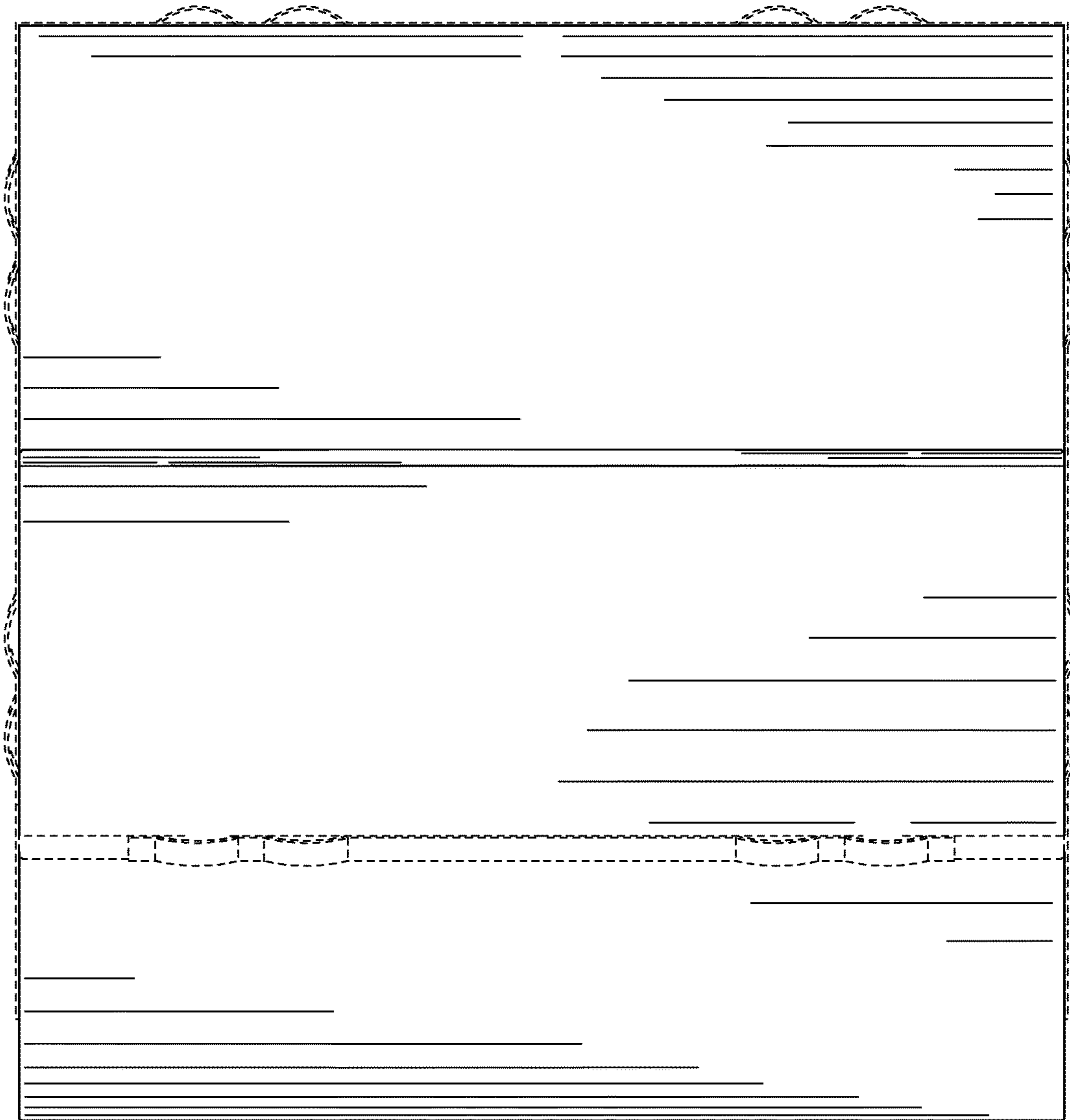

FIG. 20

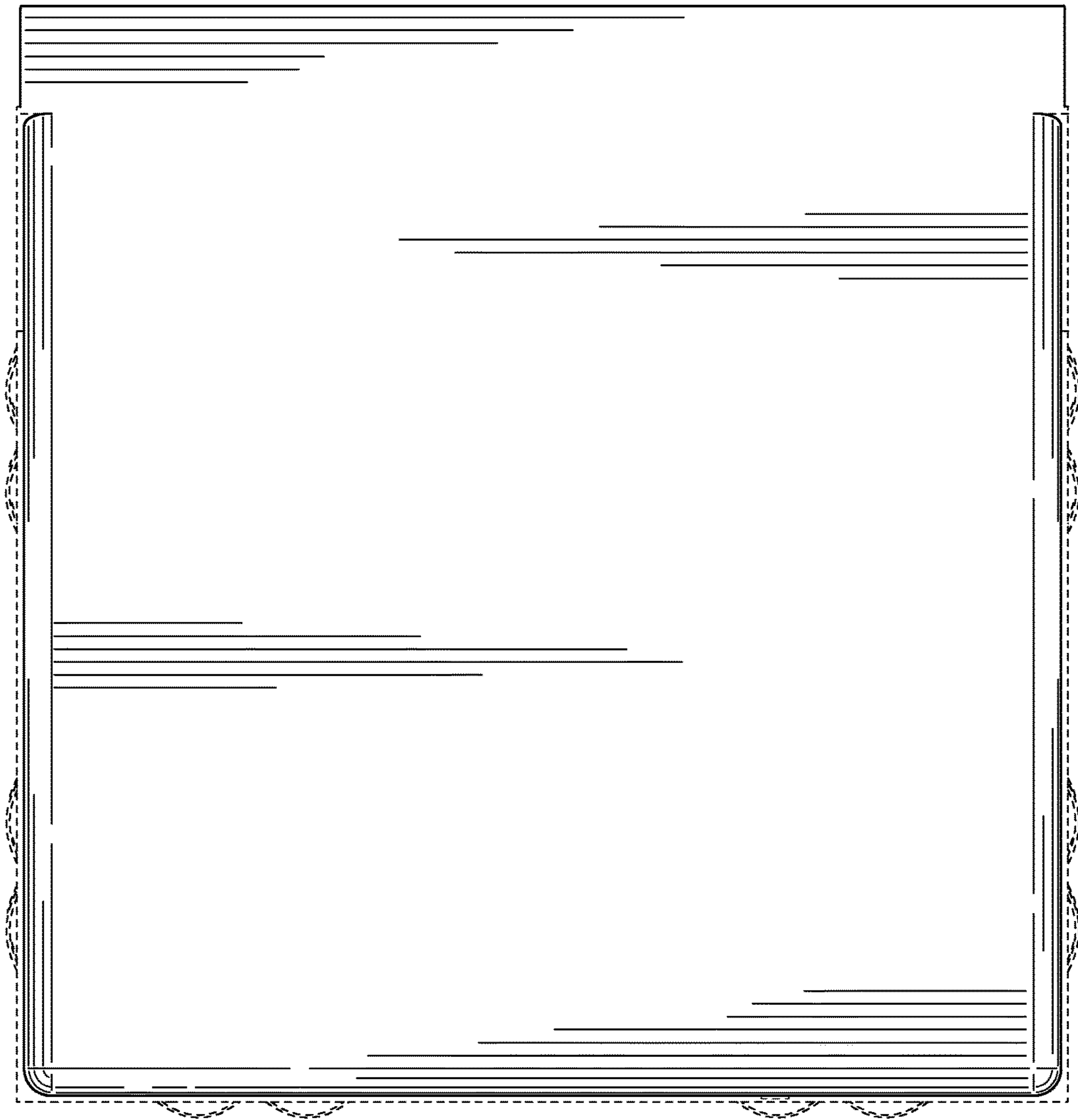

FIG. 21