



US00D798731S

(12) **United States Design Patent** (10) **Patent No.:** **US D798,731 S**
Huang (45) **Date of Patent:** **** Oct. 3, 2017**

(54) **COMBINED CONTAINER AND LID**

(71) Applicant: **Markwins Beauty Products, Inc.**, City of Industry, CA (US)

(72) Inventor: **Emily Huang**, City of Industry, CA (US)

(73) Assignee: **Markwins Beauty Products, Inc.**, City of Industry, CA (US)

(**) Term: **15 Years**

(21) Appl. No.: **29/602,275**

(22) Filed: **Apr. 28, 2017**

(51) **LOC (10) Cl.** **09-01**

(52) **U.S. Cl.**

USPC **D9/643**; D9/451; D28/79

(58) **Field of Classification Search**

USPC D7/510-511, 514-515, 619.2, 623, 628, D7/527, 392, 392.1; D9/600, 643, 451; 206/494, 457, 459.1, 459.5; 220/890, 220/376; D3/271.1; D28/79, 87

CPC B65D 51/245; B65D 5/4258; B65D 2203/00; B65D 2203/02; B65D 81/60; B65D 81/365; B65D 81/366; B65D 81/368; B65D 47/40; B65D 41/50

See application file for complete search history.

(56) **References Cited**

U.S. PATENT DOCUMENTS

D125,754 S *	3/1941	Colwell	D9/600
D284,726 S *	7/1986	Appel	D9/643
D490,588 S *	6/2004	Baker	D9/643
D510,960 S	10/2005	Choi		
D515,761 S	2/2006	Slight et al.		
D517,421 S *	3/2006	Terrasi	D9/643
D527,520 S *	9/2006	Green	D3/271.1

(Continued)

OTHER PUBLICATIONS

Print-out of YouTube webpage showing a craft tutorial video entitled "DIY Lip Gloss {Easy}! How to Make Miniature Soda Lip Balm! Coke & More—Cool DIY Crafts—Tutorials," Publication date: Jan. 7, 2017, 1 page <https://www.youtube.com/watch?v=vUJ3DvAYH4c>.

(Continued)

Primary Examiner — Sandra Morris

(74) *Attorney, Agent, or Firm* — Danton K. Mak; Leech Tishman Fuscaldo & Lampl

(57) **CLAIM**

I claim the ornamental design for the combined container and lid, as shown and described.

DESCRIPTION

FIG. 1 is a top perspective view of the subject combined container and lid;

FIG. 2 is a front side elevation view of the combined container and lid shown in FIG. 1;

FIG. 3 is a rear side elevation view of the combined container and lid shown in FIG. 1;

FIG. 4 is a first lateral side elevation view of the combined container and lid shown in FIG. 1, as seen from the left side of FIG. 1.

FIG. 5 is a second lateral side elevation view of the combined container and lid shown in FIG. 1, as seen from the right side of FIG. 1.

FIG. 6 is a top plan view of the combined container and lid shown in FIG. 1;

FIG. 7 is a bottom plan view of the combined container and lid shown in FIG. 1; and,

FIG. 8 is an exploded top perspective view of the combined container and lid shown in FIG. 1, with the lid removed and raised above the container.

The broken lines in the figures are included for the purpose of illustrating a portion of the subject combined container and lid, that forms no part of the claimed design.

1 Claim, 7 Drawing Sheets



(56)

References Cited

U.S. PATENT DOCUMENTS

7,290,361 B2 *	11/2007	Liao	B65D 51/245 220/376
D594,285 S *	6/2009	Merey	D7/628
D633,654 S *	3/2011	Berkete	D28/79
D691,478 S	10/2013	Yip	
D698,610 S *	2/2014	Tavoularis, II	D7/628
D698,611 S *	2/2014	Tavoularis, II	D7/628
D704,061 S *	5/2014	Yip	D9/451
D706,639 S	6/2014	Lichten	
D720,183 S *	12/2014	Chiang	D7/510
D724,389 S *	3/2015	Yip	D7/628

OTHER PUBLICATIONS

Print-out of YouTube webpage showing a craft idea video entitled “DIY Crafts: DIY EOS—2 Movie Snack Inspired EOS Lip Balm Container Craft Ideas,” Publication date: Dec. 21, 2015, 1 page https://www.youtube.com/watch?v=1tg_W2VIsJs.

Print-out of YouTube webpage showing a craft tutorial video entitled “DIY Ice Cream EOS—How to Make Cute Ice Cream Cone Lip Balm!” Publication date: Jun. 3, 2015, 1 page.

Print-out of YouTube webpage showing a craft tutorial video entitled “DIY Starbucks EOS Lip balm Container,” Publication date: Dec. 22, 2015, 1 page <https://www.youtube.com/watch?v=UiNbzPnQLJs>.

* cited by examiner

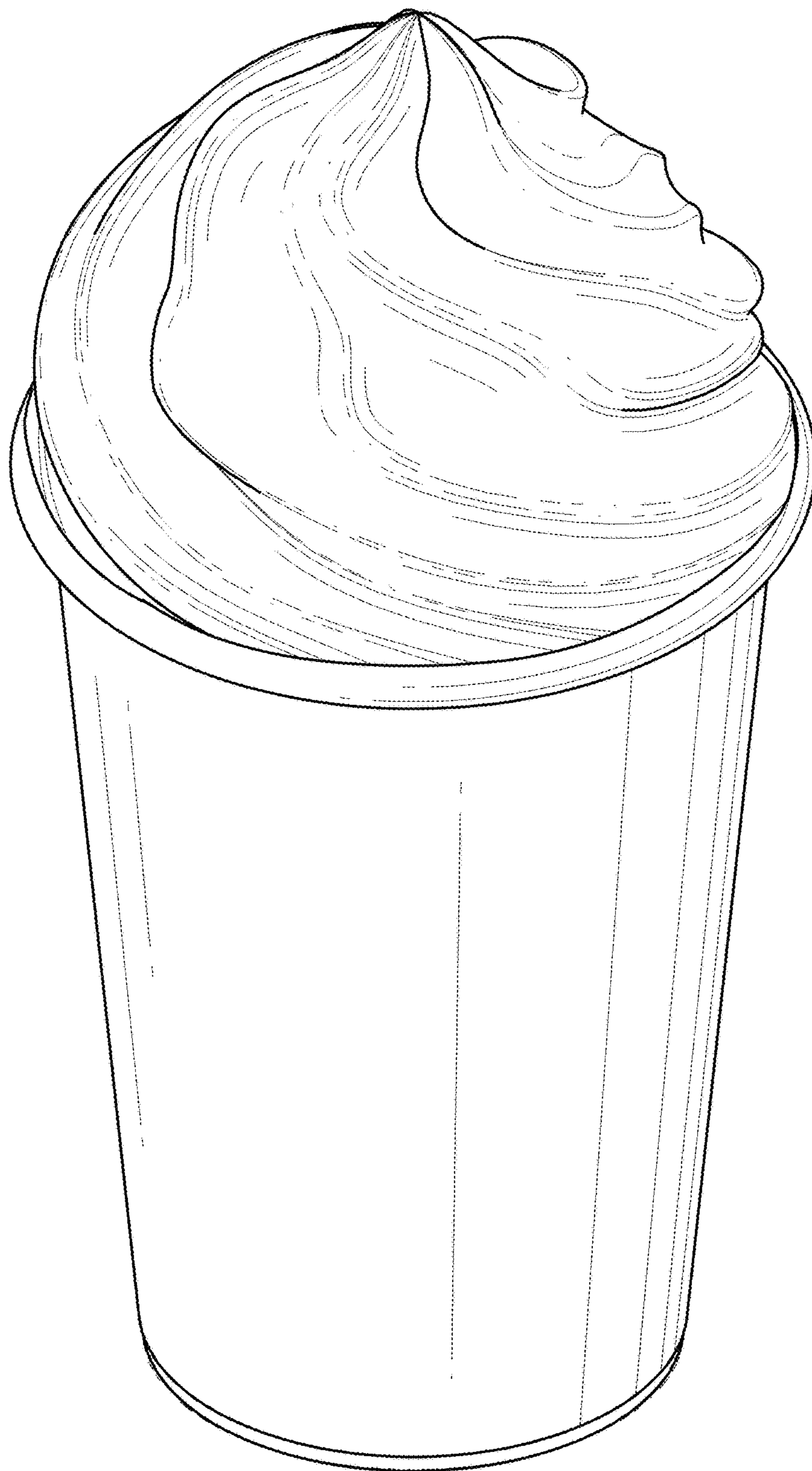

FIG. 1

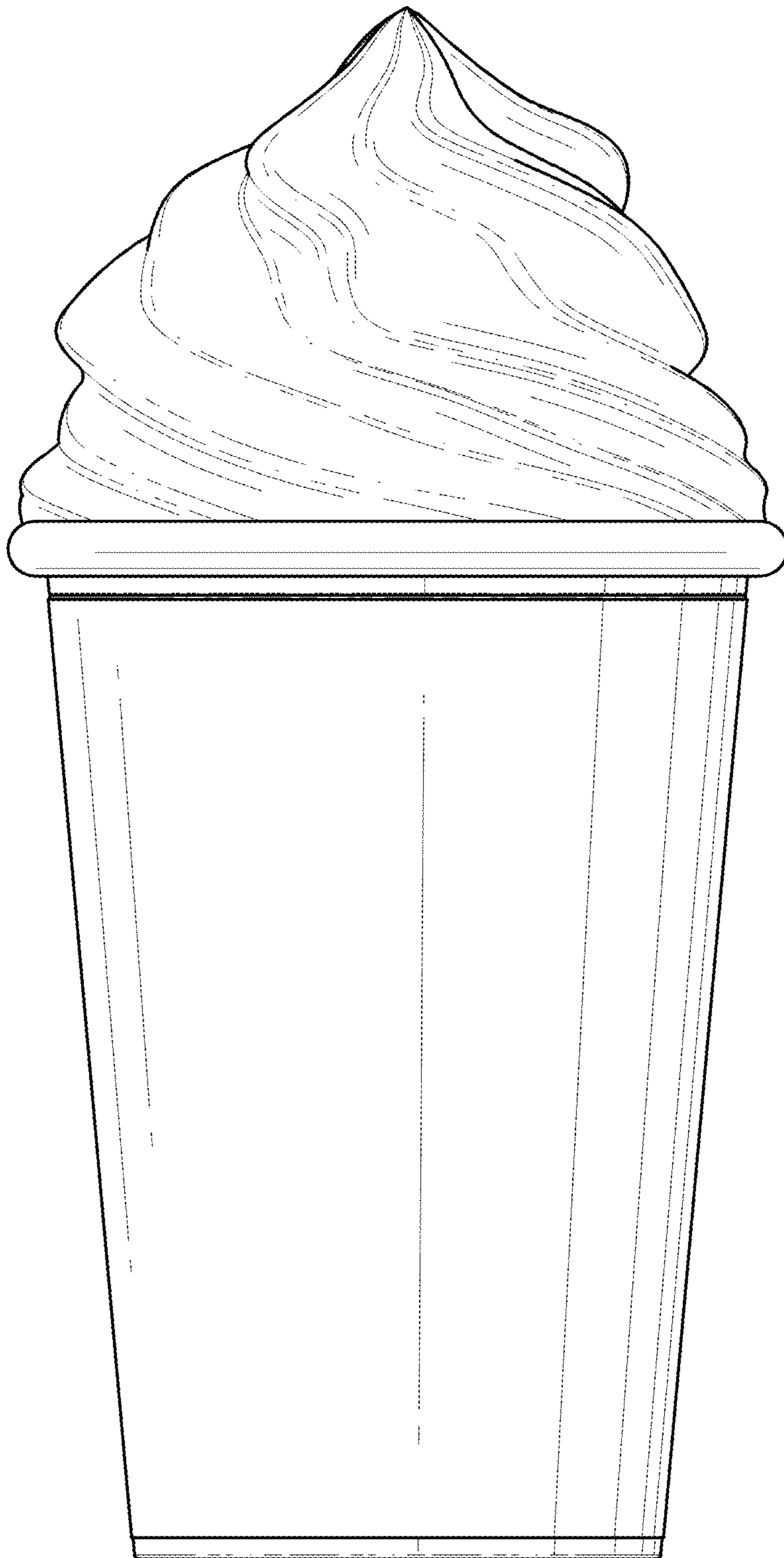

FIG. 2

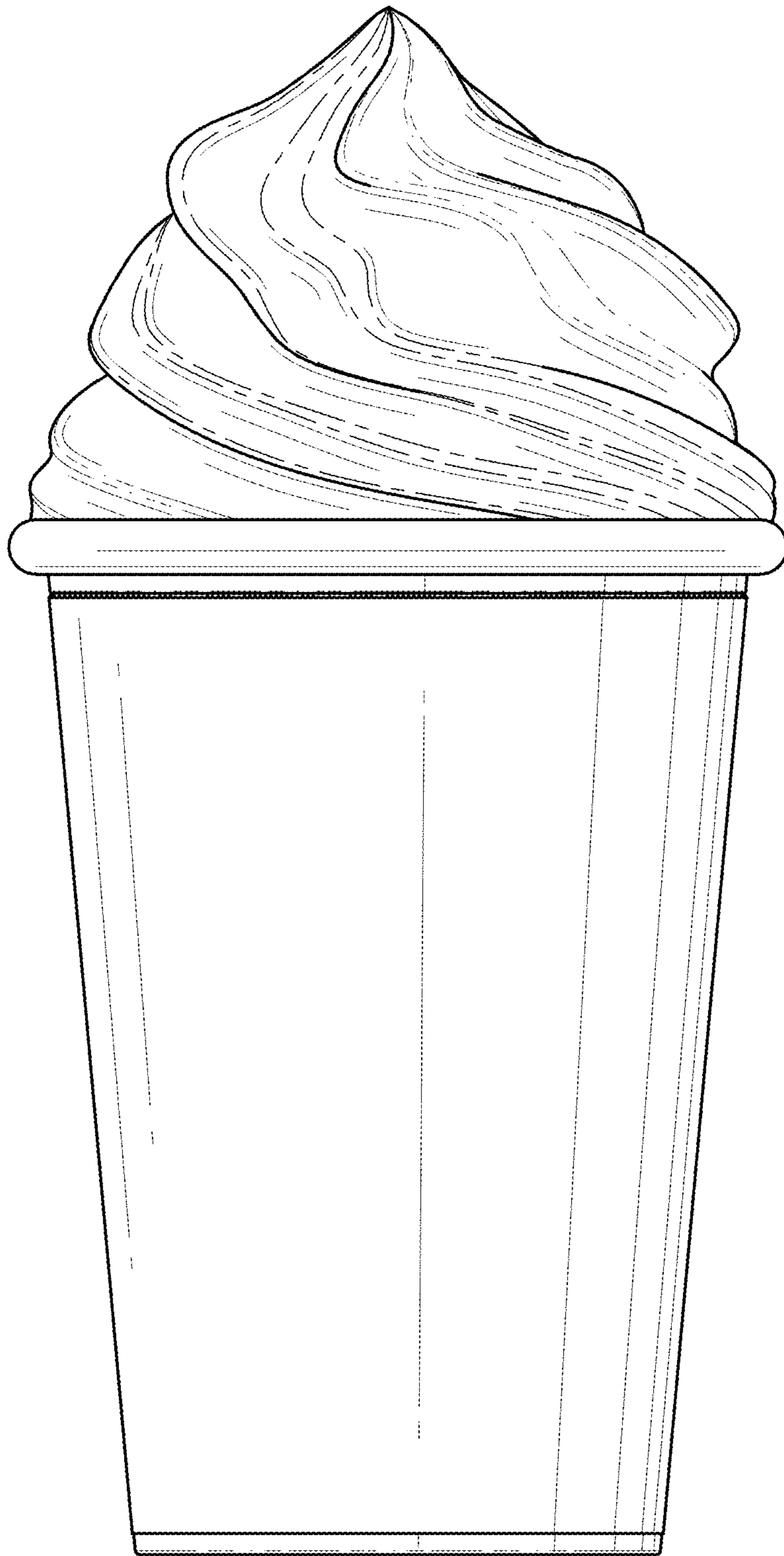

FIG. 3

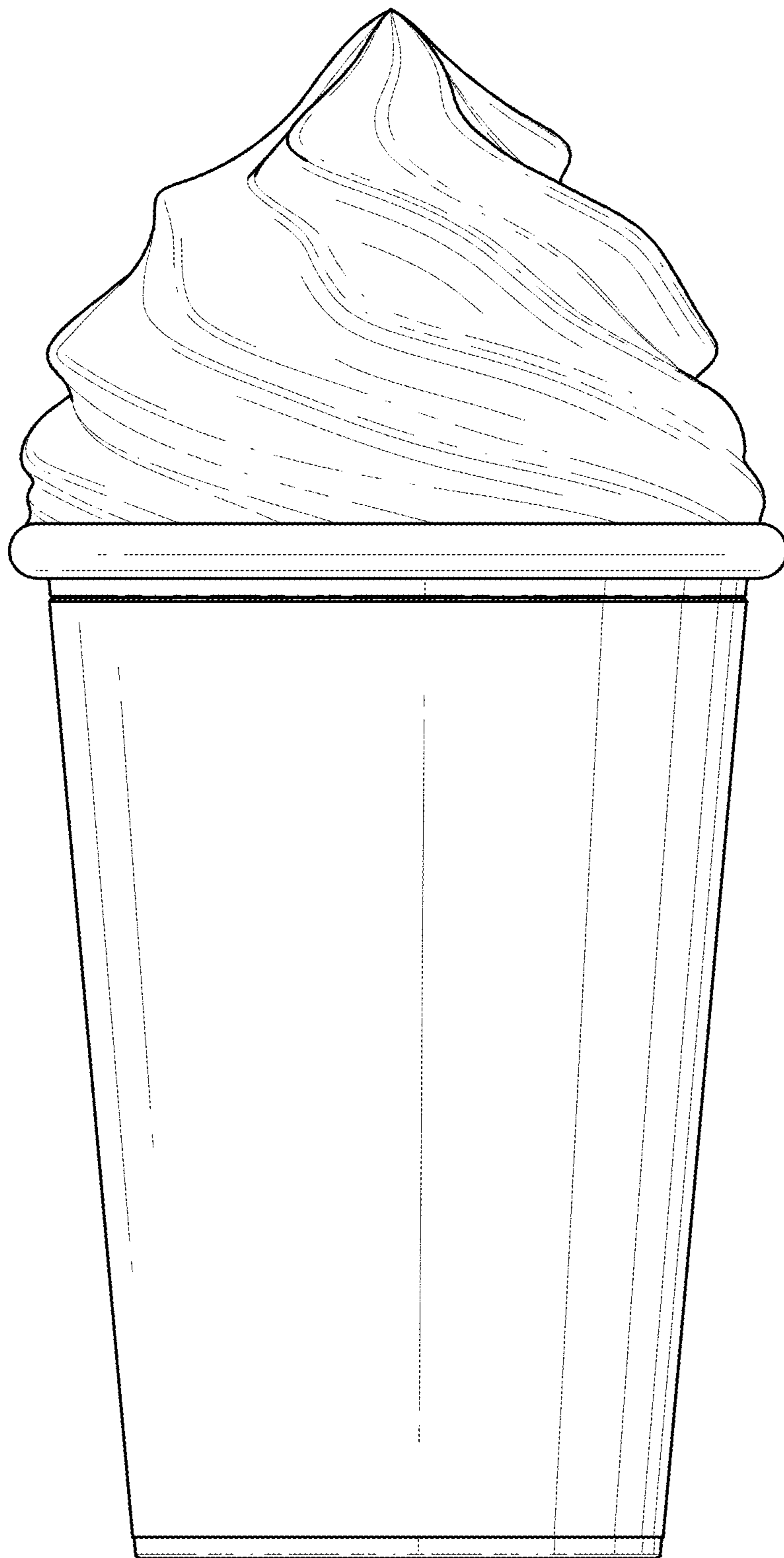

FIG. 4

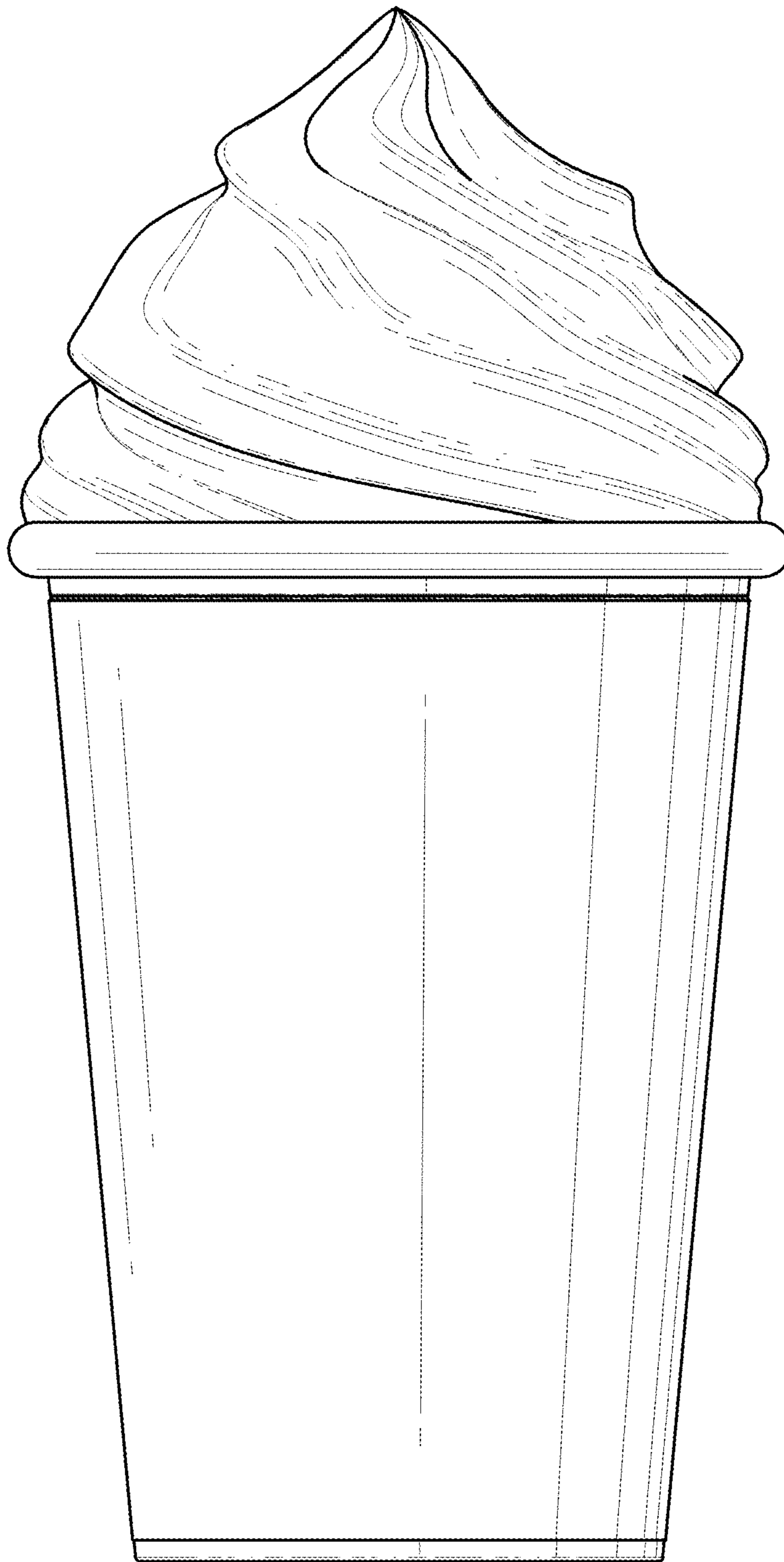

FIG. 5

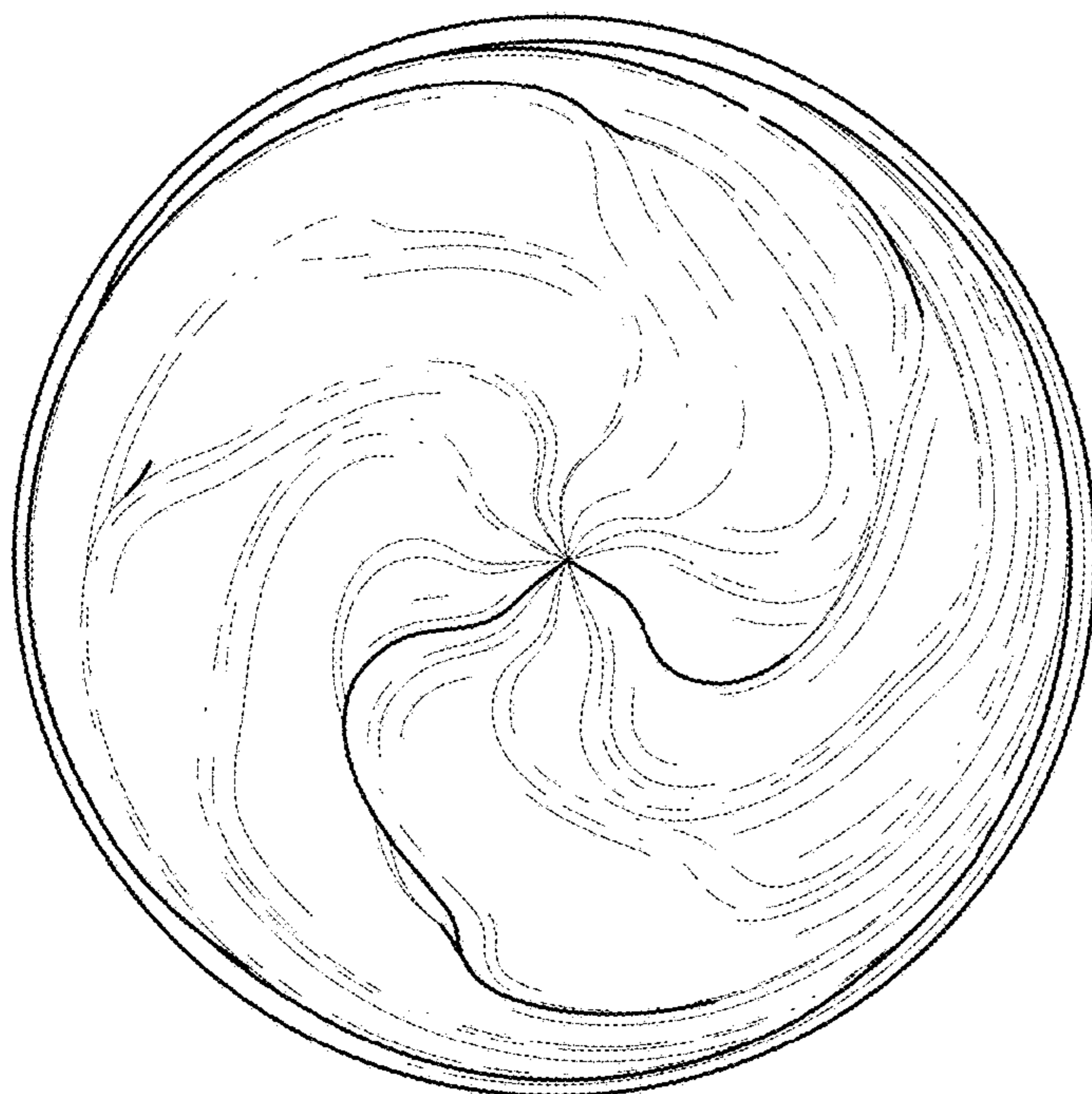

FIG. 6

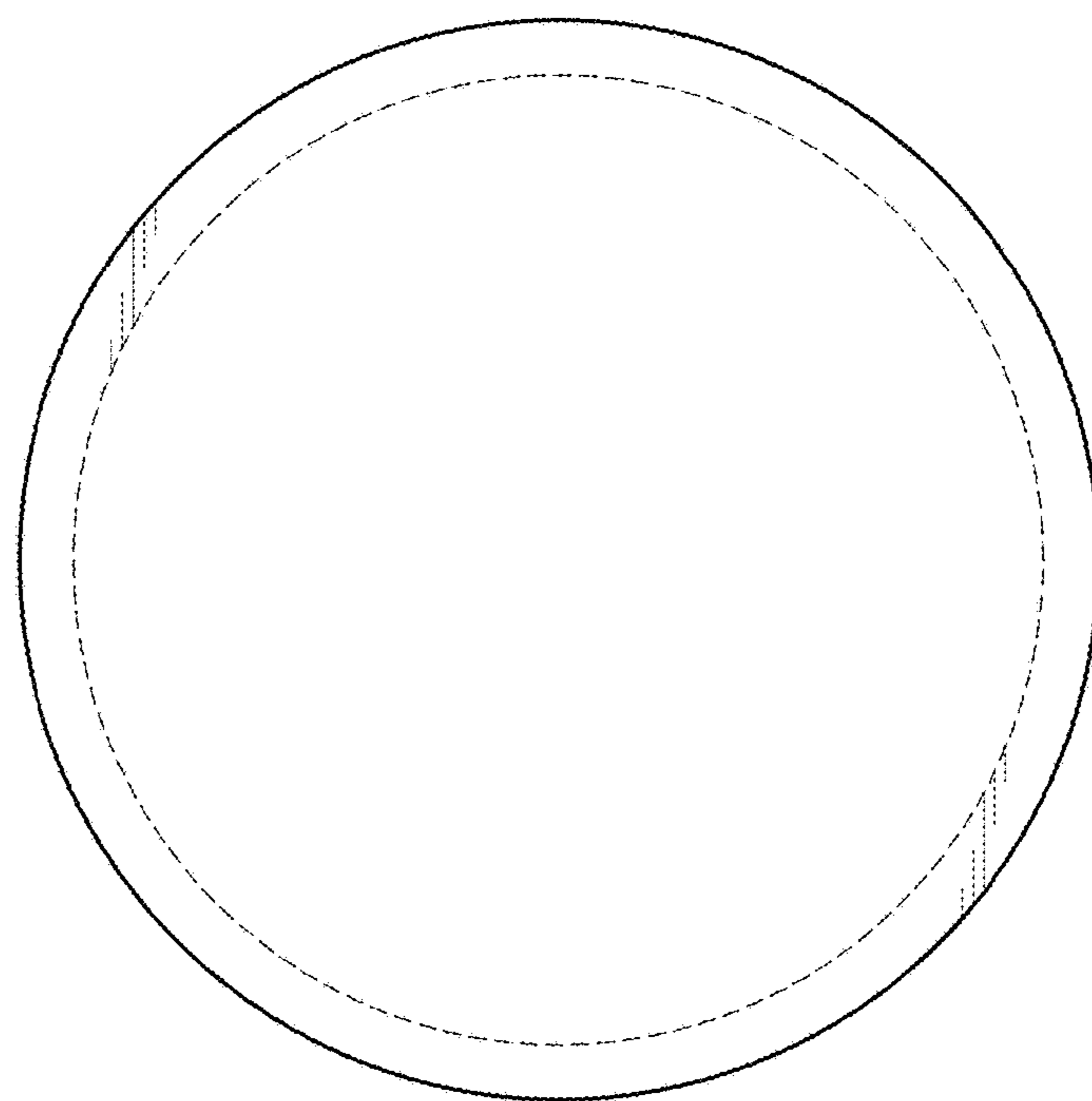

FIG. 7

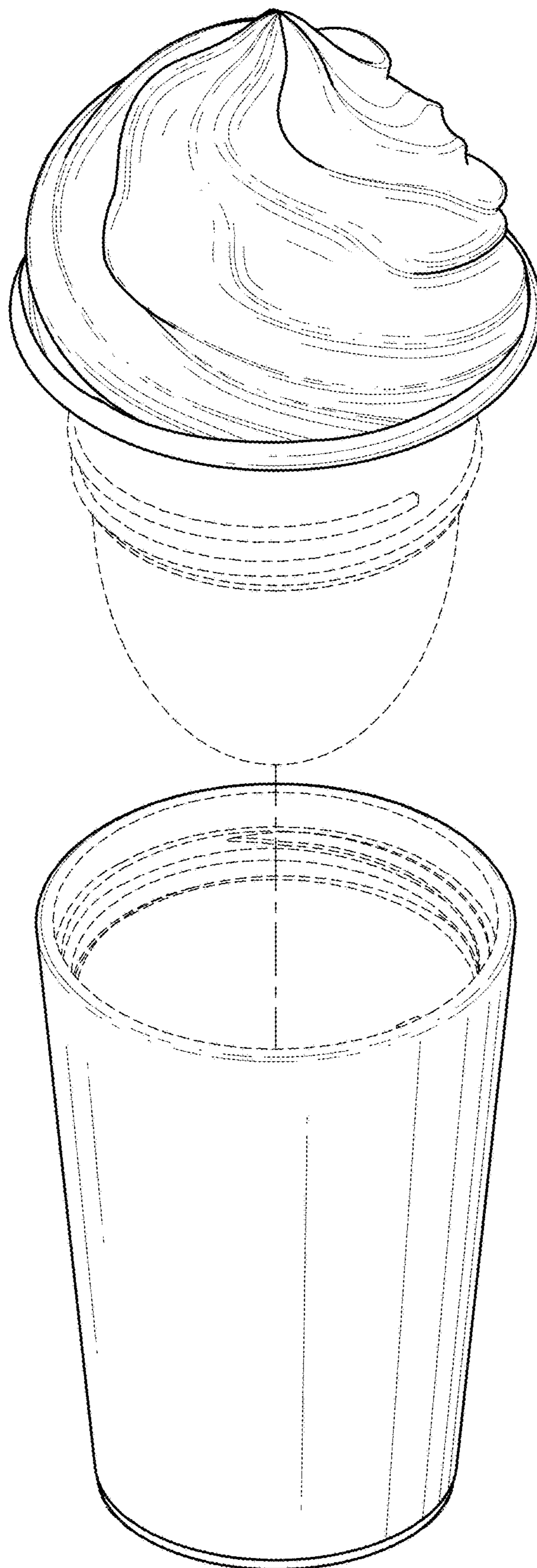

FIG. 8