



US00D798655S

(12) **United States Design Patent** (10) **Patent No.:** **US D798,655 S**
Barberi (45) **Date of Patent:** **** *Oct. 3, 2017**

(54) **SET OF HANDLES FOR COOKWARE VESSEL WITH LID**

DESCRIPTION

(71) Applicant: **Meyer Intellectual Properties Limited**, Kowloon (HK)

(72) Inventor: **Philip D. Barberi**, San Ramon, CA (US)

(73) Assignee: **MEYER INTELLECTUAL PROPERTIES LIMITED**, Hong Kong (CN)

(*) Notice: This patent is subject to a terminal disclaimer.

(**) Term: **15 Years**

(21) Appl. No.: **29/532,752**

(22) Filed: **Jul. 9, 2015**

(51) **LOC (10) Cl.** **07-02**

(52) **U.S. Cl.**
USPC **D7/395**; D7/393; D7/394

(58) **Field of Classification Search**
USPC D7/354-361, 393-395, 401.2, 664;
D8/107, 300, 303, 307, 313, 321;
D4/138, 129

(Continued)

(56) **References Cited**

U.S. PATENT DOCUMENTS

D482,234 S * 11/2003 Rae D7/394
6,848,592 B2 * 2/2005 Logiudice A47J 37/101
126/384.1

(Continued)

Primary Examiner — Cynthia M Chin

(74) *Attorney, Agent, or Firm* — Edward S. Sherman

(57) **CLAIM**

The ornamental design for a set of handles for cookware vessel with lid, as shown and described.

FIG. 1 is a top plan view of a set of handles for cookware vessel with lid; showing my new design, which includes an elongated and short side handle and a lid handle;

FIG. 2 is a perspective view of a first embodiment of the elongated handle of FIG. 1;

FIG. 3 is a right side elevation view, the left side elevation view being the mirror image thereof;

FIG. 4 is a top plan thereof;

FIG. 5 is a bottom plan view thereof;

FIG. 6 is a front side elevation view thereof;

FIG. 7 is a rear side elevation view thereof;

FIG. 8 is a perspective view of a second embodiment of the Elongated handle of FIG. 1;

FIG. 9 is a right side elevation view, the left side elevation view being the mirror image thereof;

FIG. 10 is a top plan thereof;

FIG. 11 is a bottom plan view thereof;

FIG. 12 is a front side elevation view thereof;

FIG. 13 is a front side elevation view thereof;

FIG. 14 is a perspective view of a first embodiment of the short handle of FIG. 1;

FIG. 15 is a left side elevation view, the right side elevation view being the mirror image thereof;

FIG. 16 is a top plan thereof;

FIG. 17 is a bottom plan view thereof;

FIG. 18 is a rear side elevation view thereof;

FIG. 19 is a front side elevation view thereof;

FIG. 20 is a perspective view of a second embodiment of the short handle of FIG. 1;

FIG. 21 is a left side elevation view, the right side elevation view being the mirror image thereof;

FIG. 22 is a top plan thereof;

FIG. 23 is a bottom plan view thereof;

FIG. 24 is a rear side elevation view thereof;

FIG. 25 is a front side elevation view thereof;

FIG. 26 is a perspective view of a first embodiment of the lid handle of FIG. 1;

FIG. 27 is a right side elevation view, the left side elevation view being the mirror image thereof;

FIG. 28 is a top plan thereof;

FIG. 29 is a bottom plan view thereof;

(Continued)

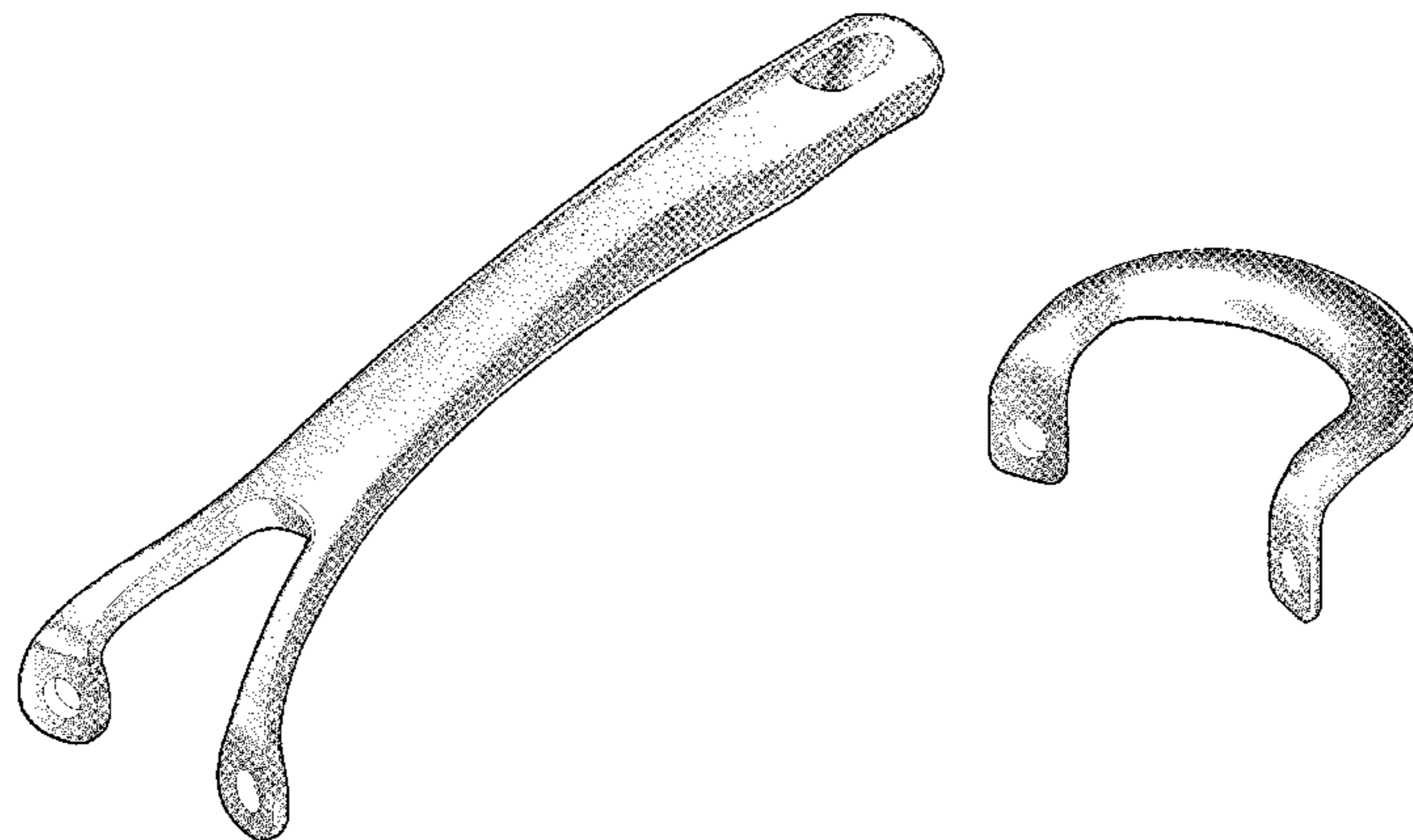

FIG. 30 is a rear side elevation view, the front side view being the mirror image thereof;
 FIG. 31 is a perspective view of a second embodiment of the lid handle of FIG. 1;
 FIG. 32 is a right side elevation view, the left side elevation view being the mirror image thereof;
 FIG. 33 is a top plan thereof;
 FIG. 34 is a bottom plan view thereof; and,
 FIG. 35 is a rear side elevation view, the front side view being the mirror image thereof.
 The broken lines in FIGS. 1-3, 6-9, 12-15, 18-21, 24-26, 29-29, 30-31 and 33-35 are for illustrative purposes only, depicting the environment of the new design, forming no part thereof as claimed. The environment of the new design includes the cookware vessel and the lid.
 The surface curvature of the various handles is identical between the first and second embodiments thereof. The second embodiment of each of the various handles has a portion with a contrasting appearance from the adjacent portion(s).

1 Claim, 19 Drawing Sheets

(58) **Field of Classification Search**
 CPC A47J 45/06; A47J 45/061; A47J 45/62;
 A47J 45/08; A47J 45/085; A47J 45/071;

A47J 45/072; B65D 25/2802; B65D
 25/2882; B65D 25/2885; B65D 25/2888;
 B65D 25/2894; Y10S 220/912

See application file for complete search history.

(56)

References Cited

U.S. PATENT DOCUMENTS

D505,046	S	*	5/2005	Rae	D7/394
D579,714	S	*	11/2008	Cheng	D7/360
D581,721	S	*	12/2008	Rae	D7/360
D587,519	S	*	3/2009	Cheng	D7/360
D637,861	S	*	5/2011	Degnan	D7/354
D642,013	S	*	7/2011	Rae	D7/394
D643,681	S	*	8/2011	Bodum	D7/395
D644,484	S	*	9/2011	Rae	D7/394
D657,996	S	*	4/2012	Rae	D7/394
D667,685	S	*	9/2012	Rae	D7/394
D672,193	S	*	12/2012	Rae	D7/394
D699,510	S	*	2/2014	Rae	D7/394
D704,991	S	*	5/2014	Rae	D7/394
D705,001	S	*	5/2014	Rae	D7/395
D706,077	S	*	6/2014	Wright	D7/394
D729,570	S	*	5/2015	Barberi	D7/395
D730,685	S	*	6/2015	Barberi	D7/395
D757,487	S	*	5/2016	McConnell	D7/395
D757,488	S	*	5/2016	McConnell	D7/395
2004/0060936	A1	*	4/2004	Logiudice	A47J 37/101 220/254.1

* cited by examiner

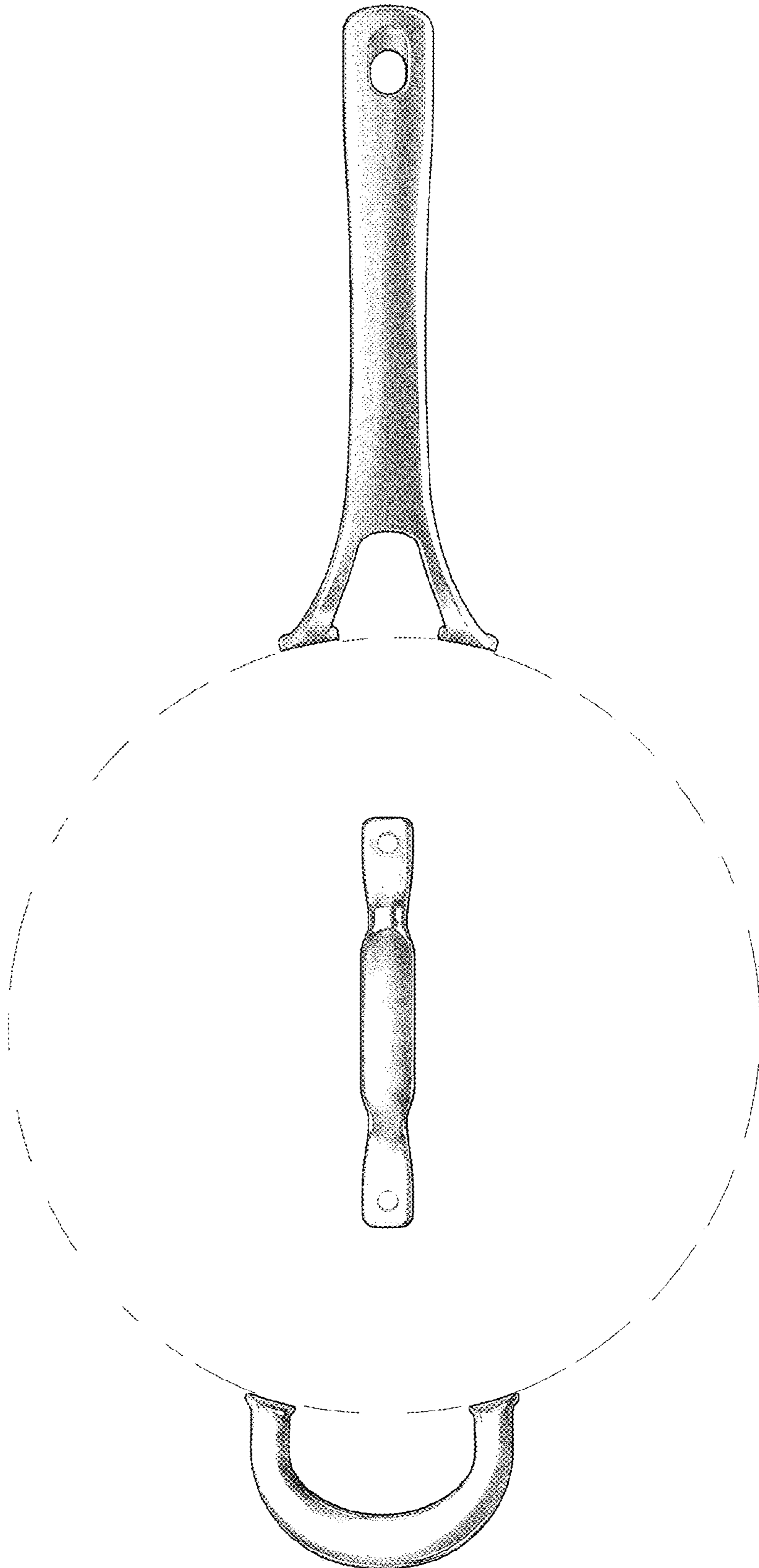

FIG. 1

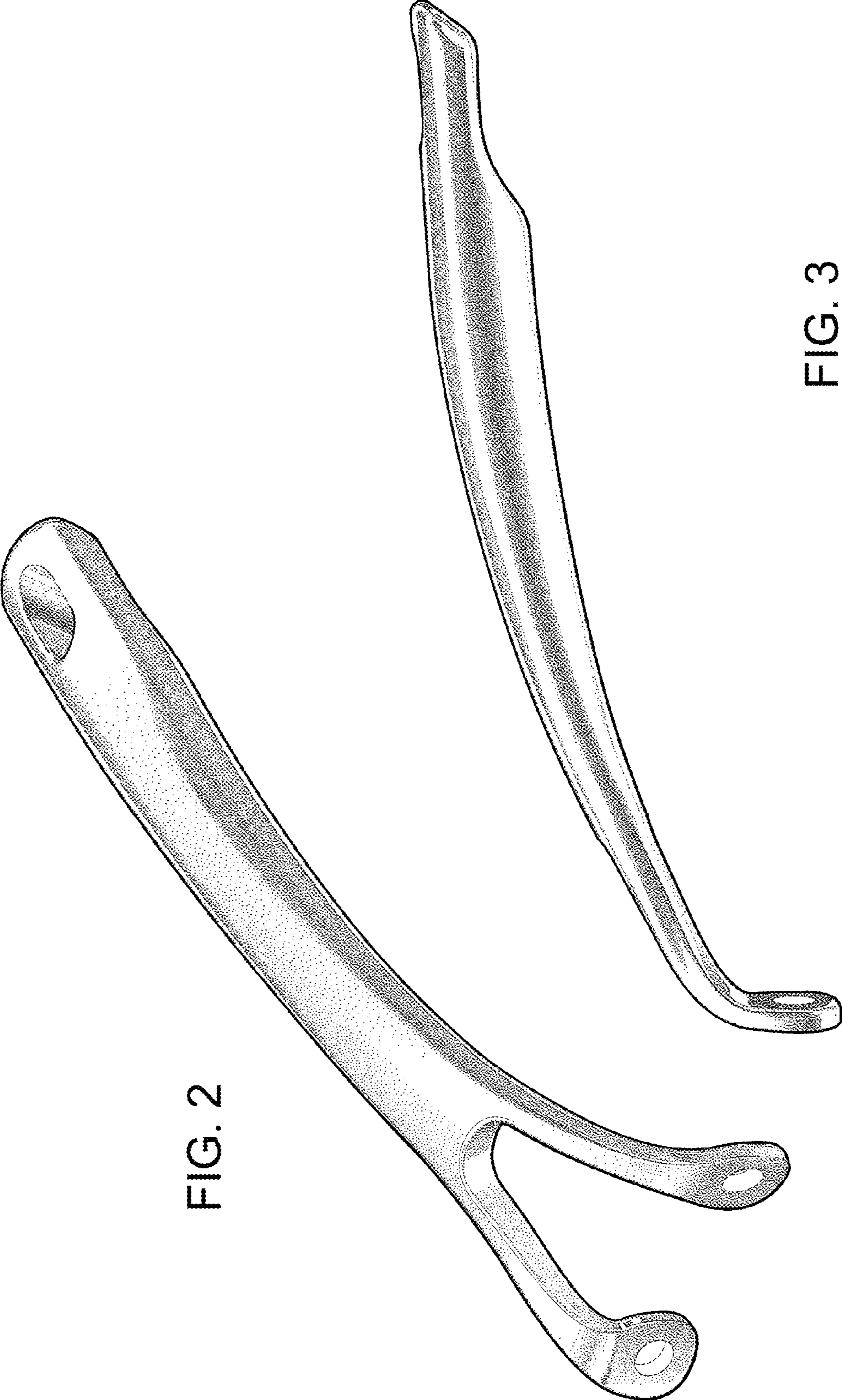

FIG. 2

FIG. 3

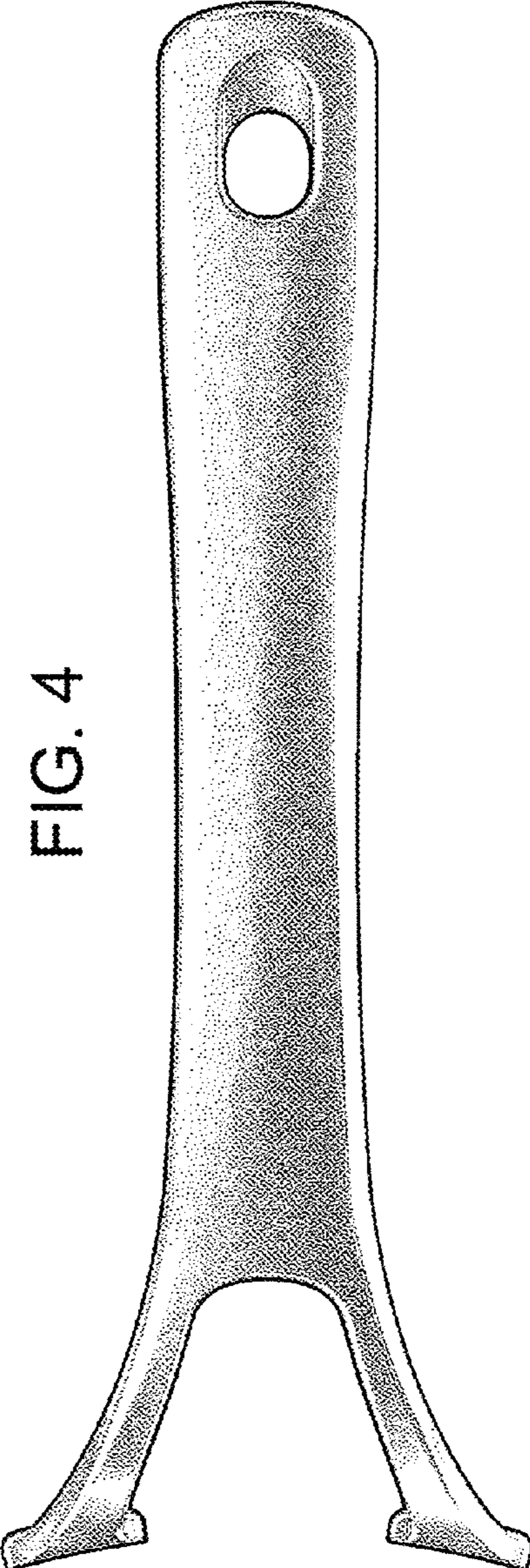

FIG. 4

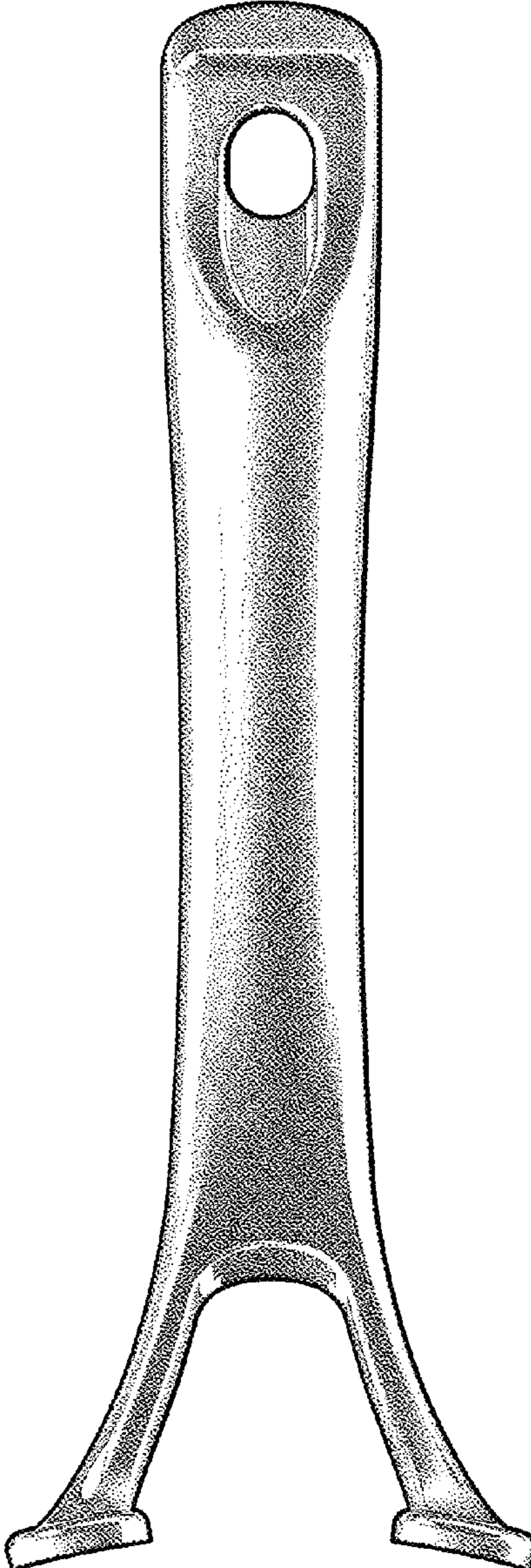

FIG. 5

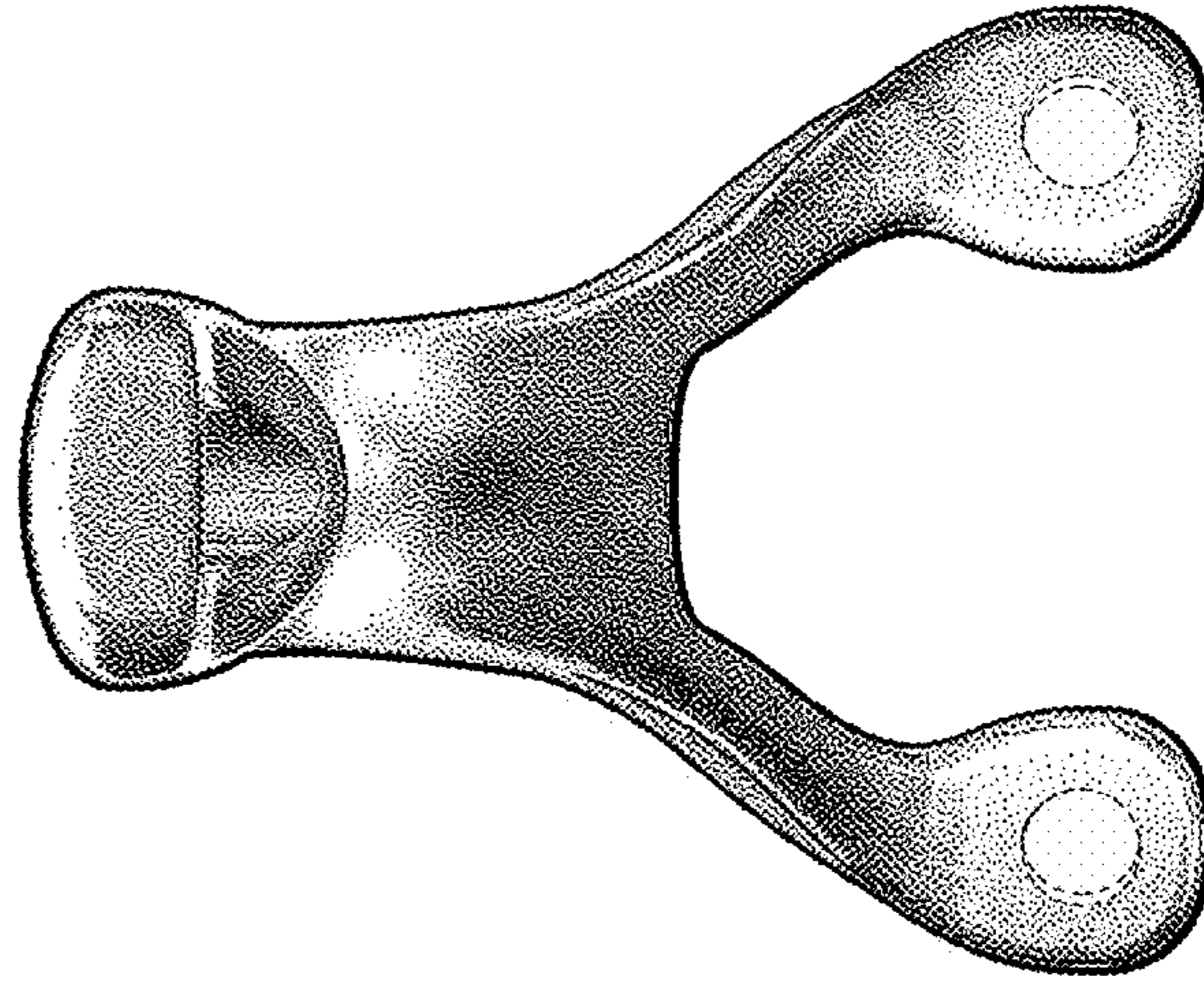

FIG. 7

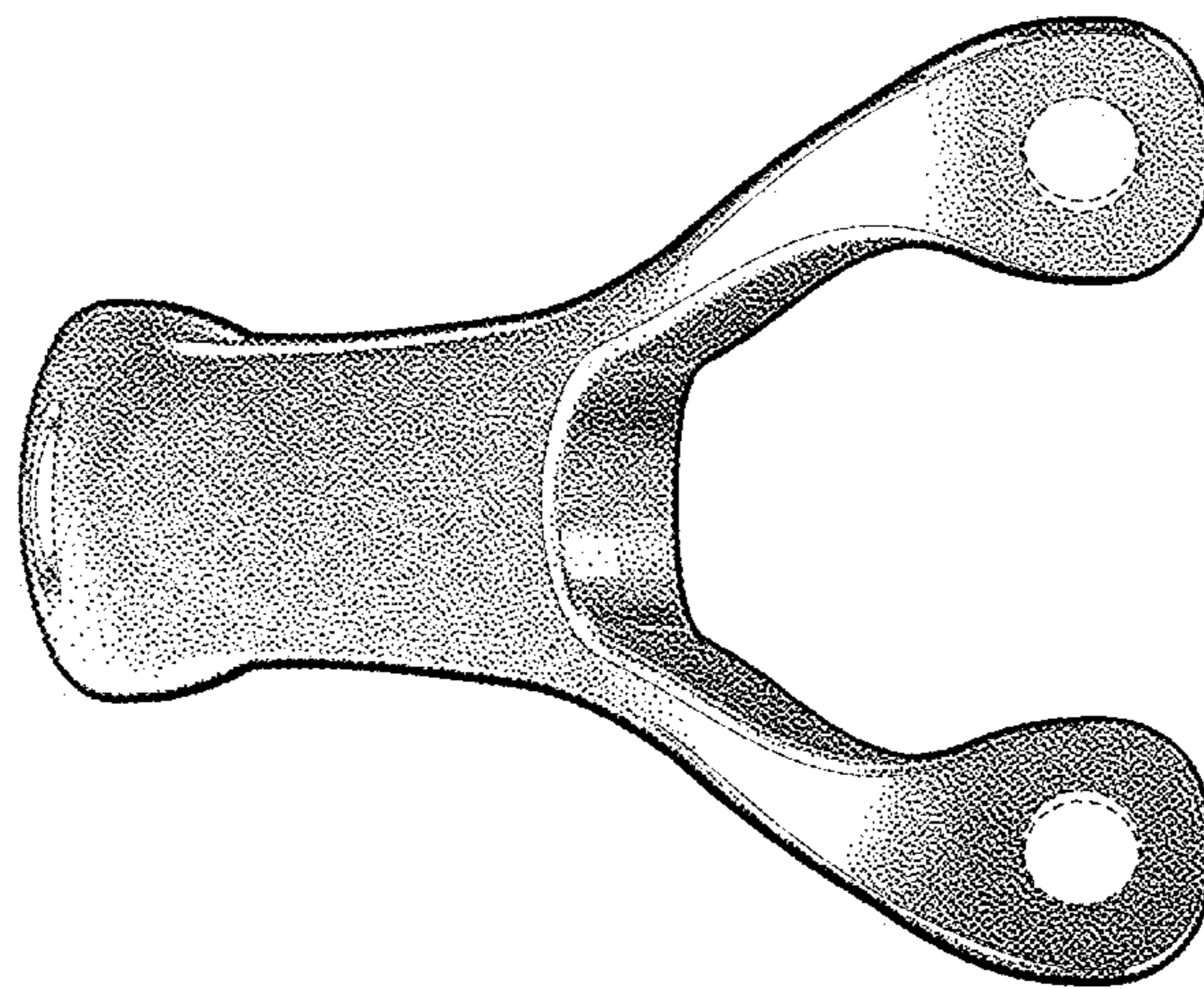

FIG. 6

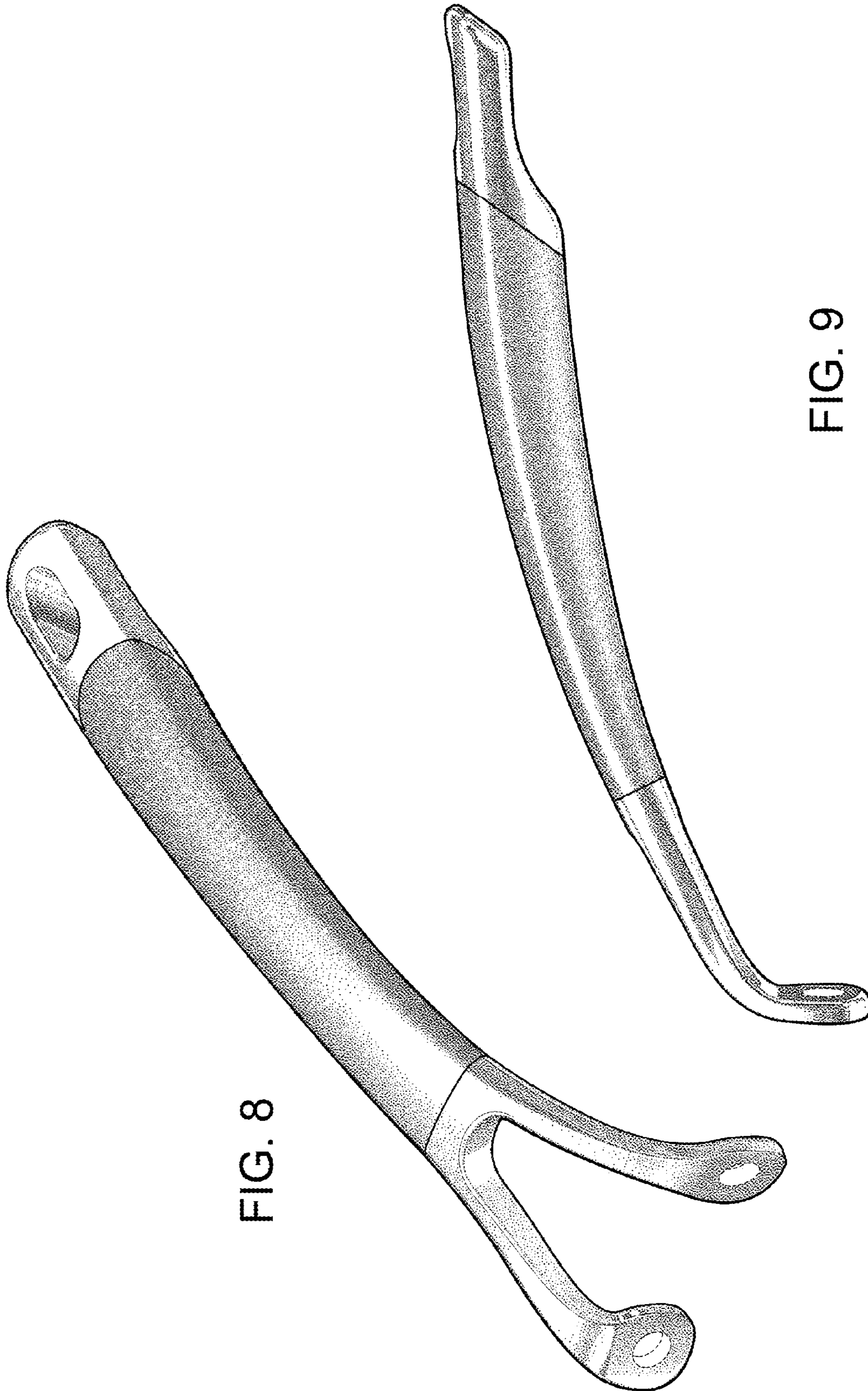

FIG. 8

FIG. 9

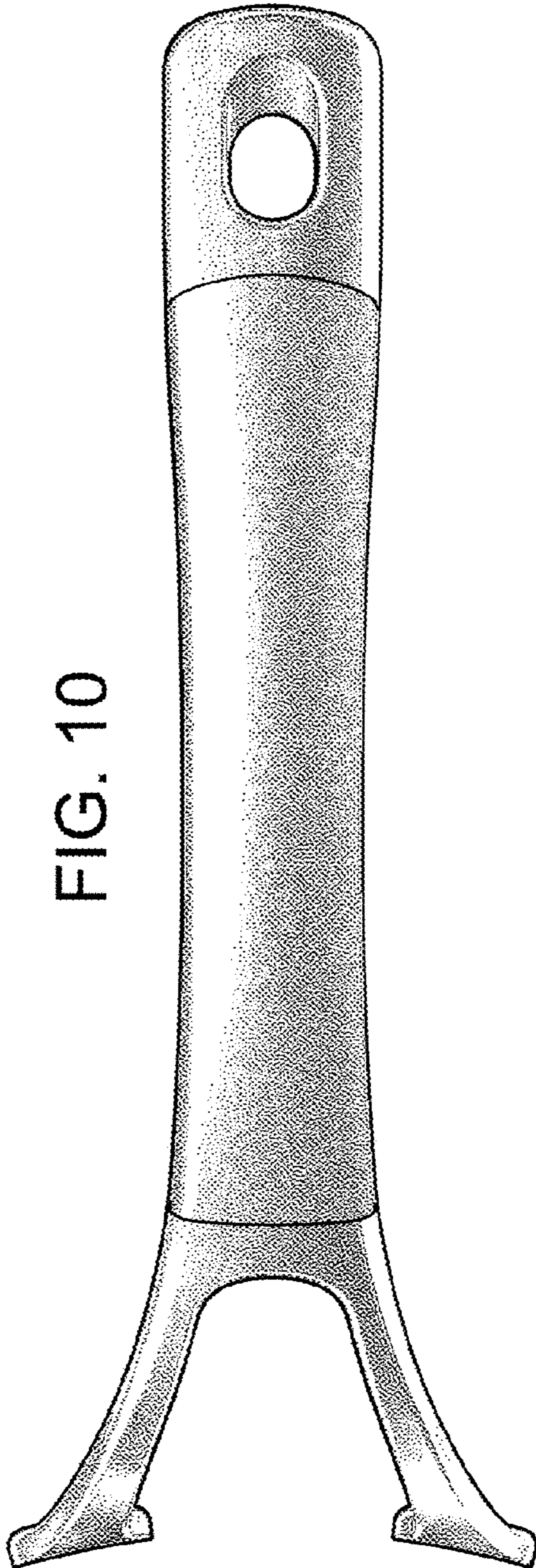

FIG. 10

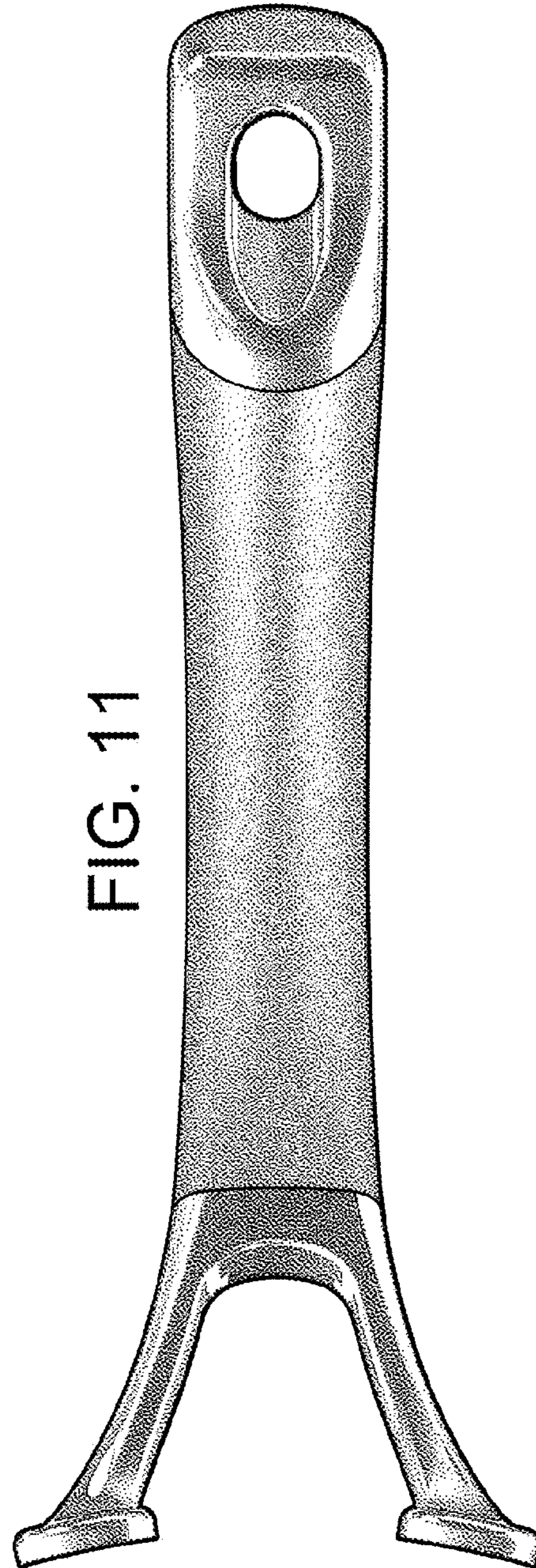

FIG. 11

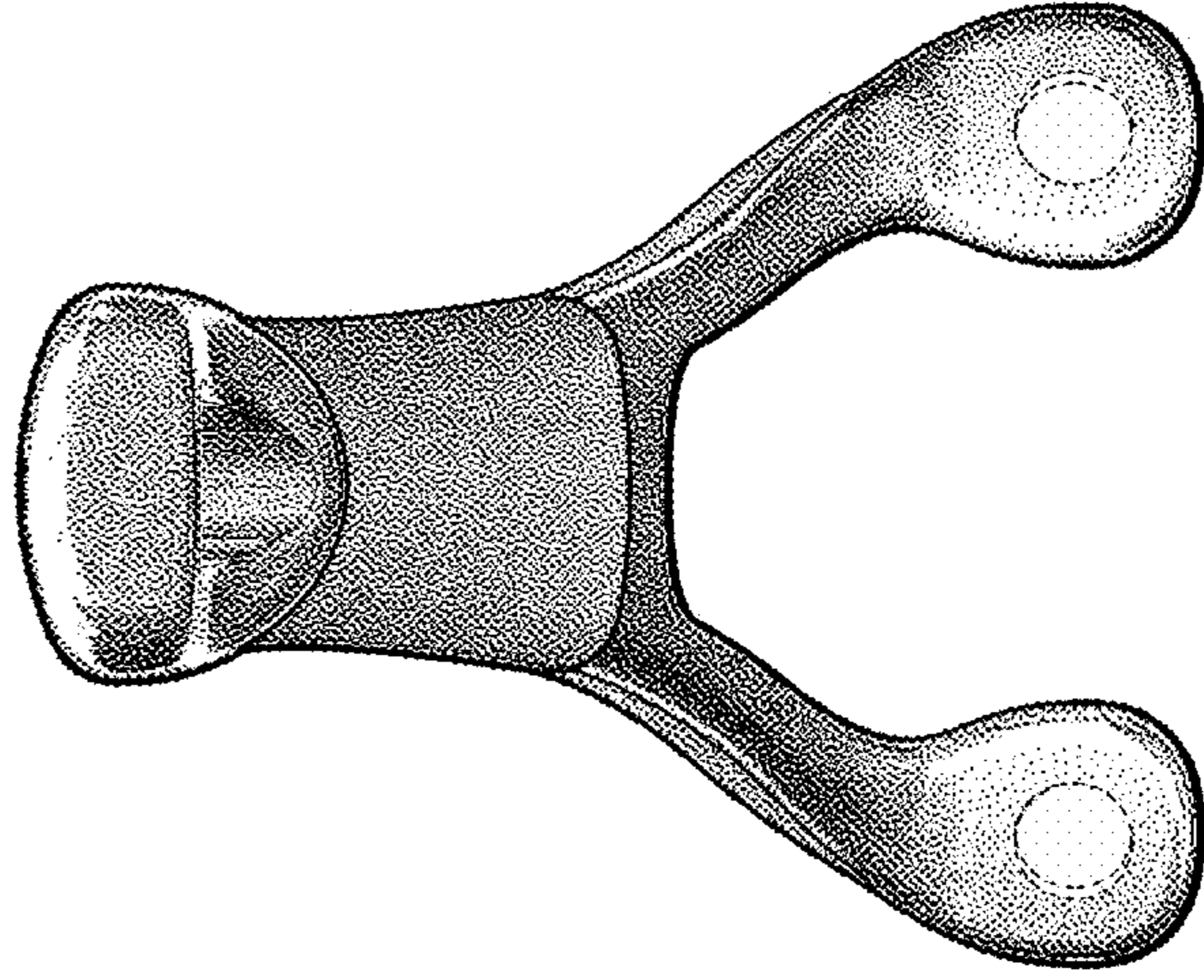

FIG. 13

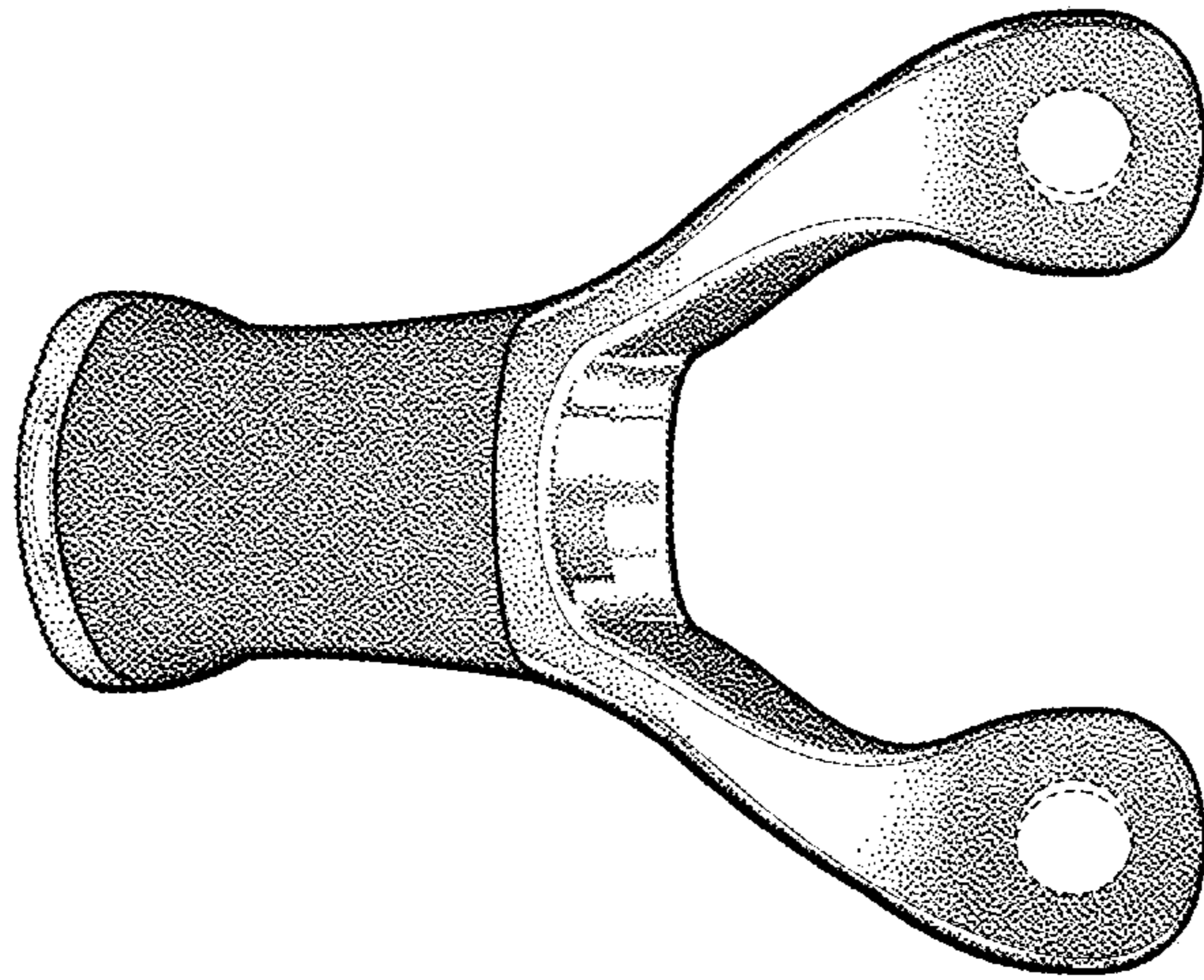

FIG. 12

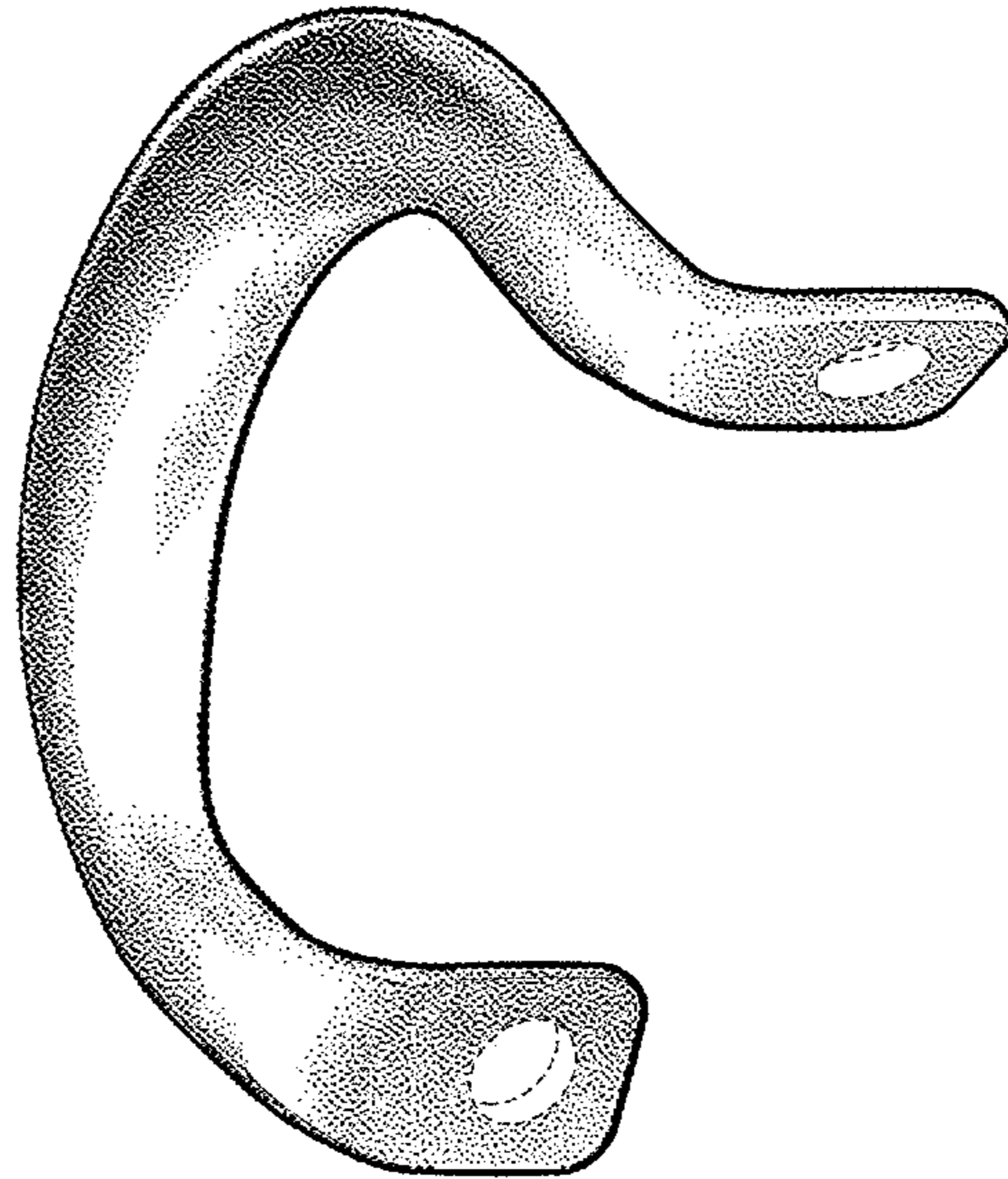

FIG. 14

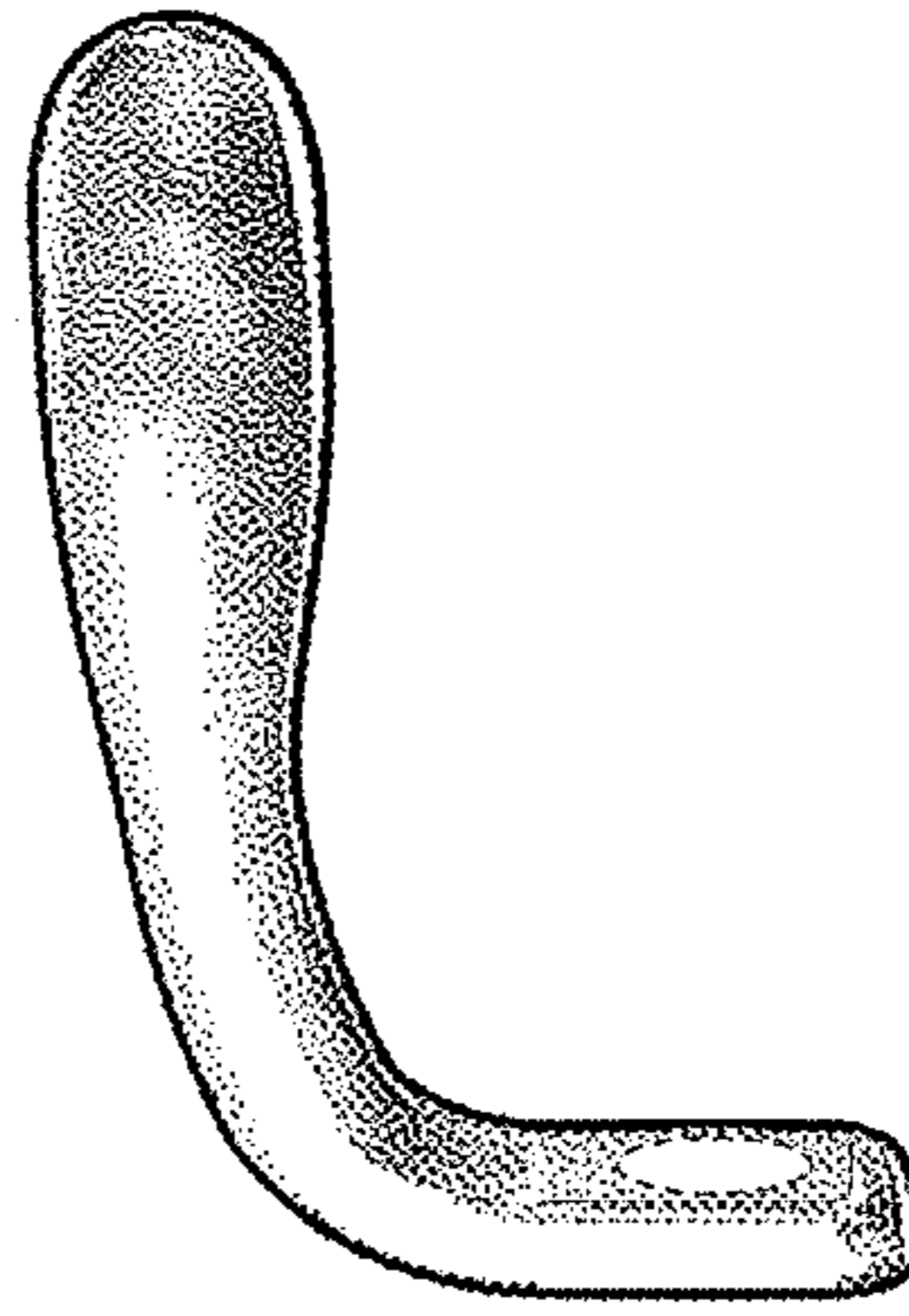

FIG. 15

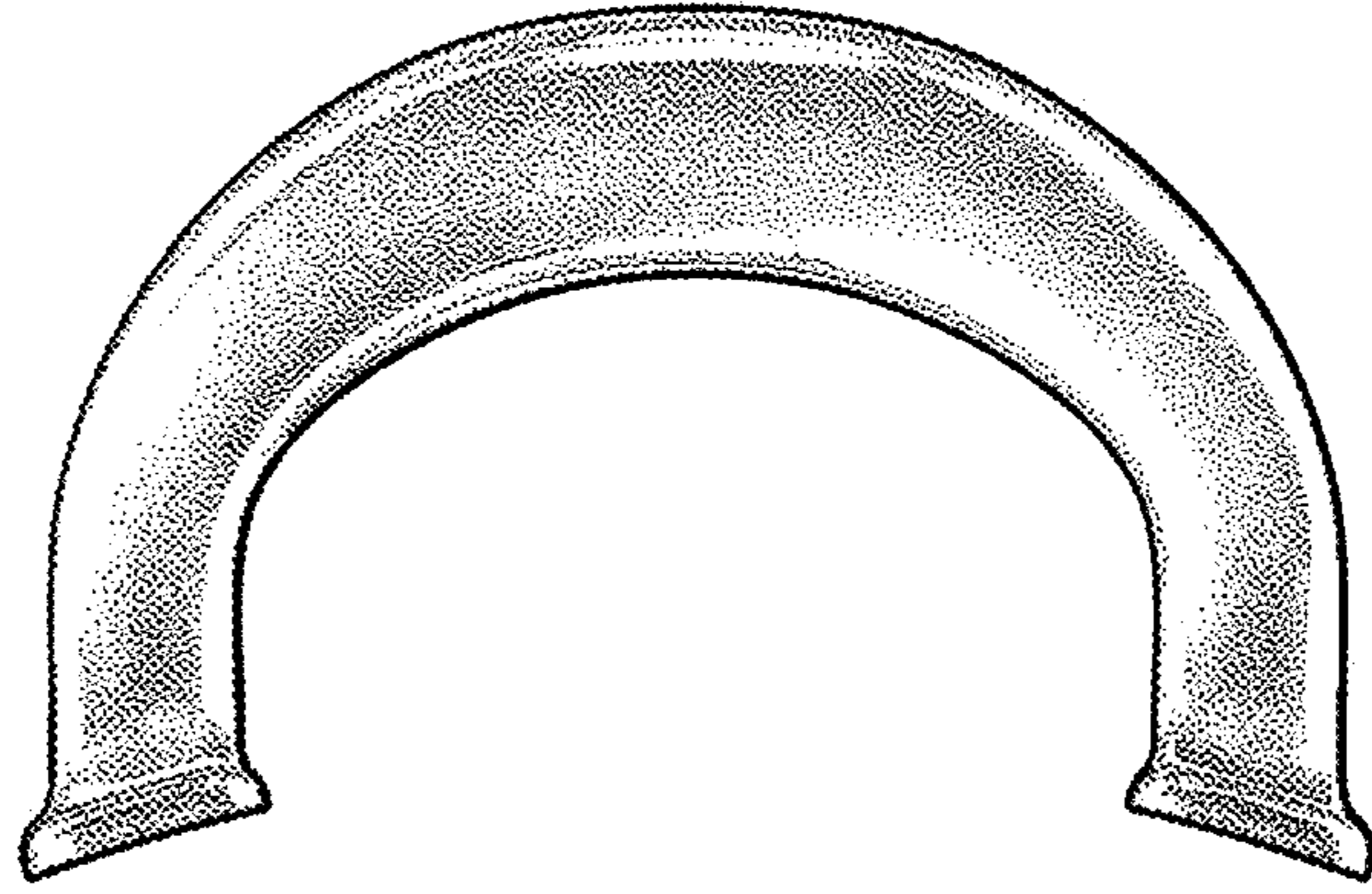

FIG. 17

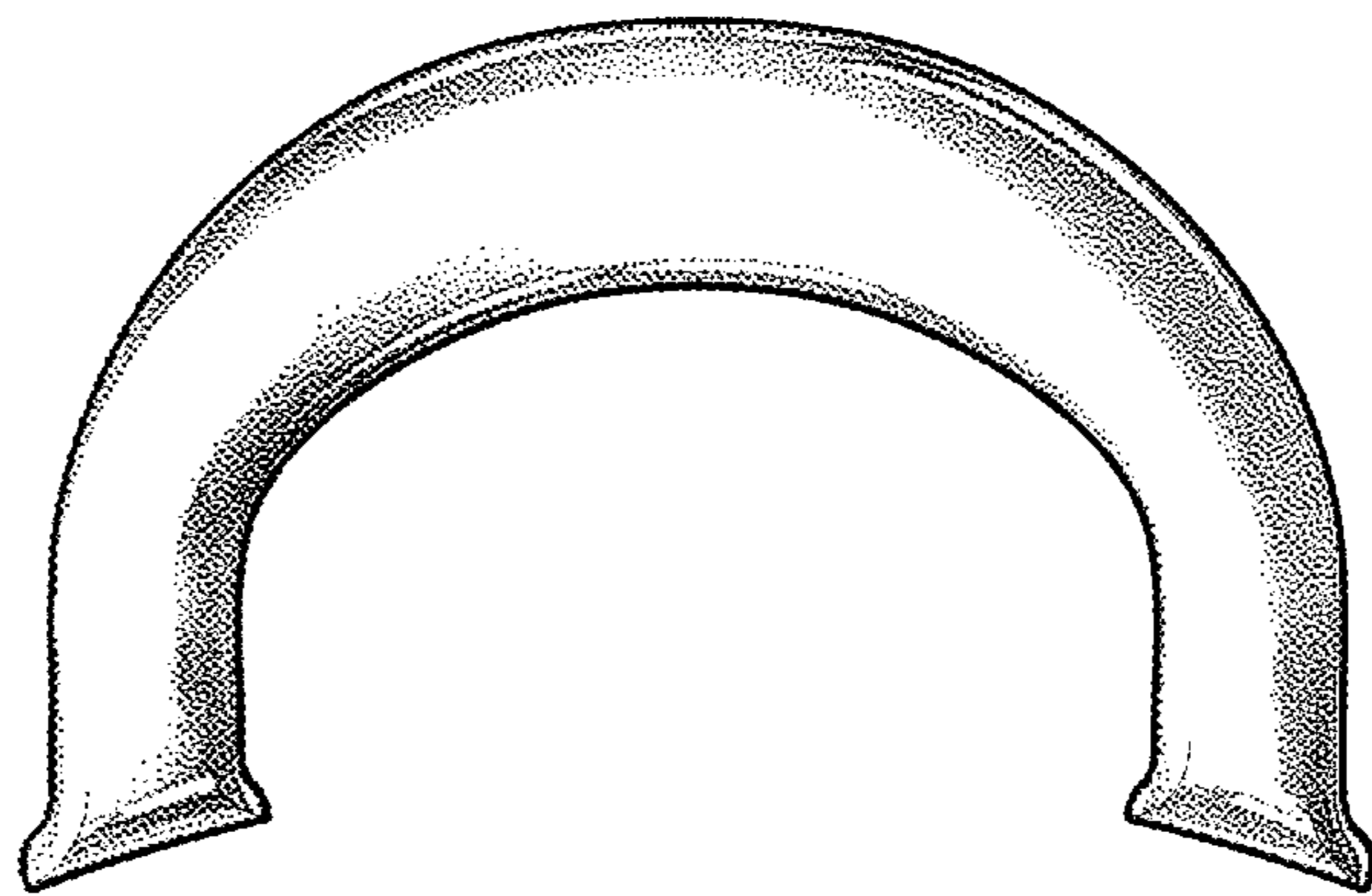

FIG. 16

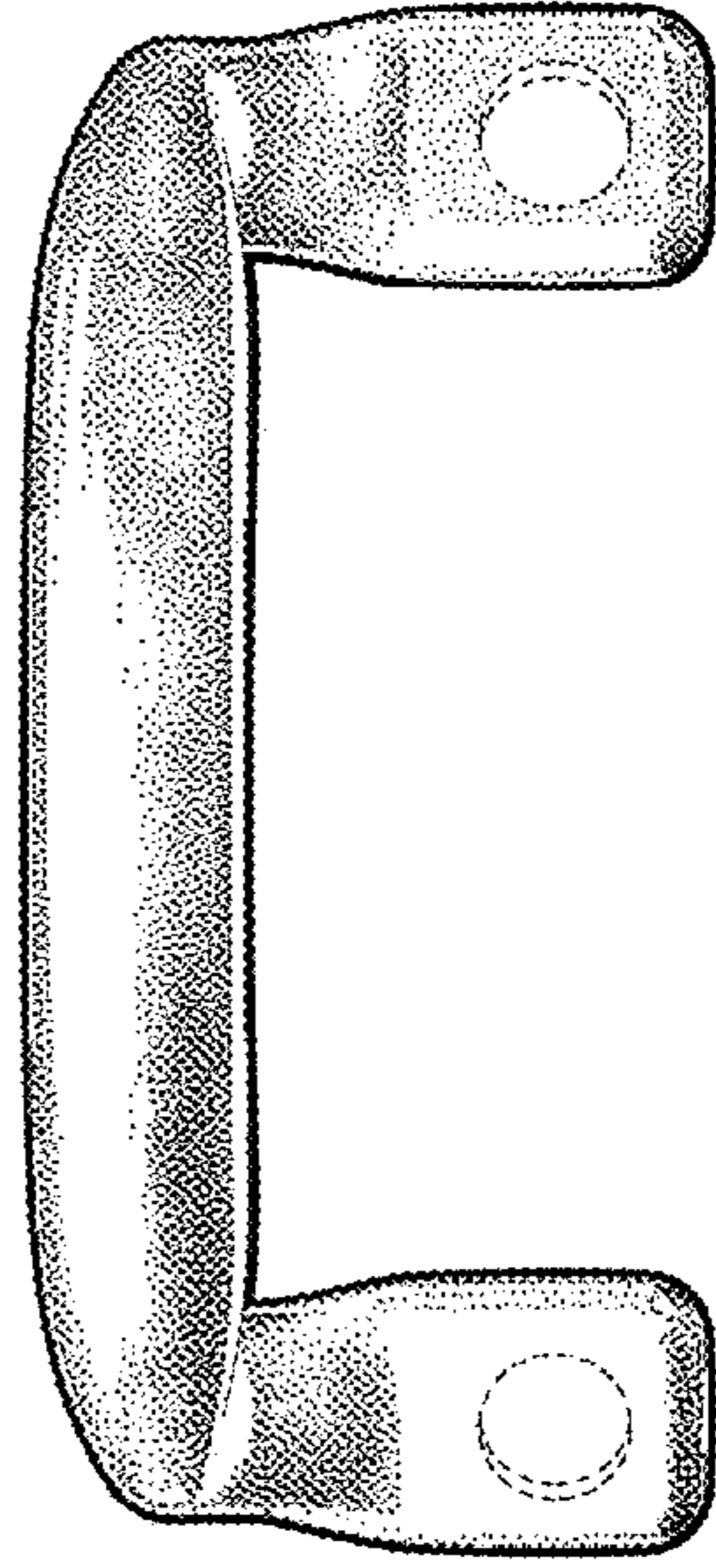

FIG. 19

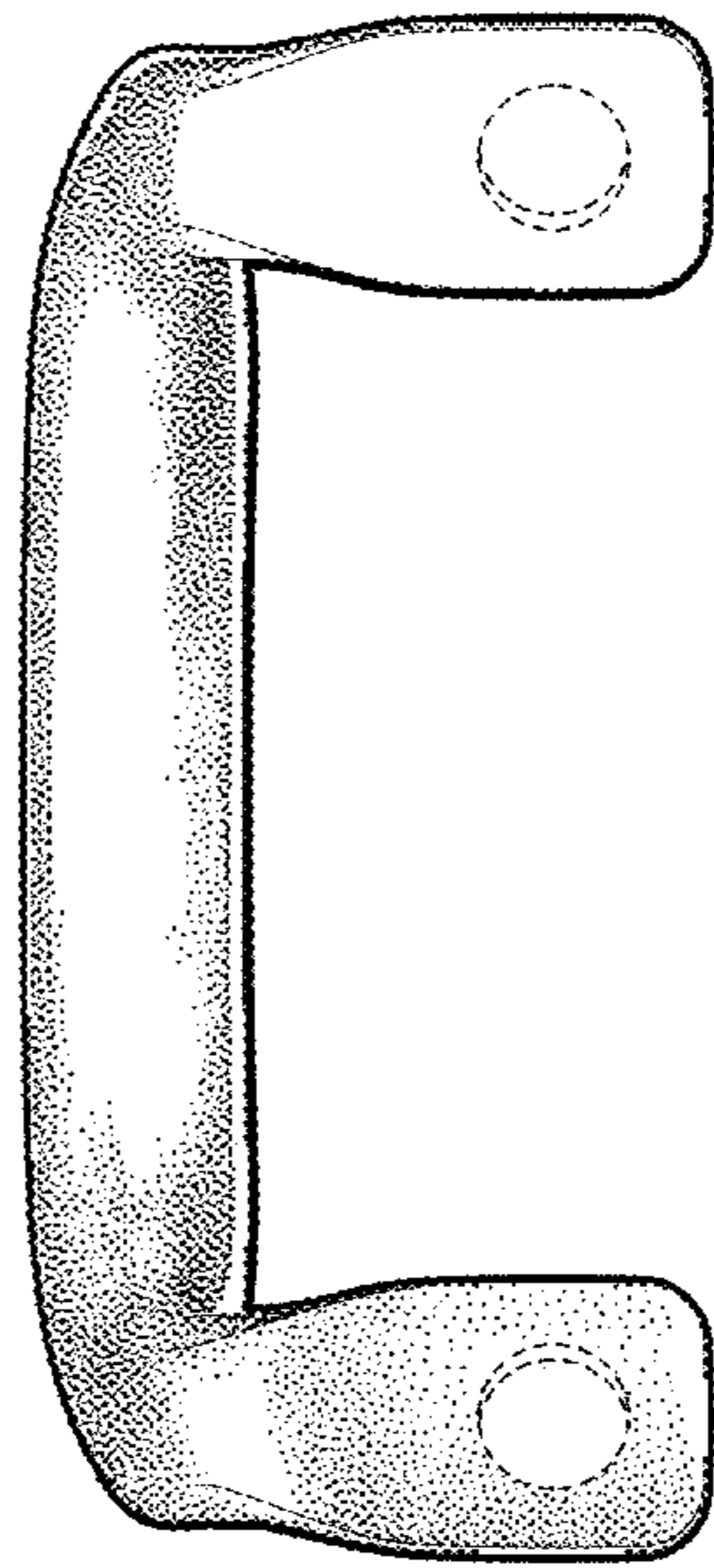

FIG. 18

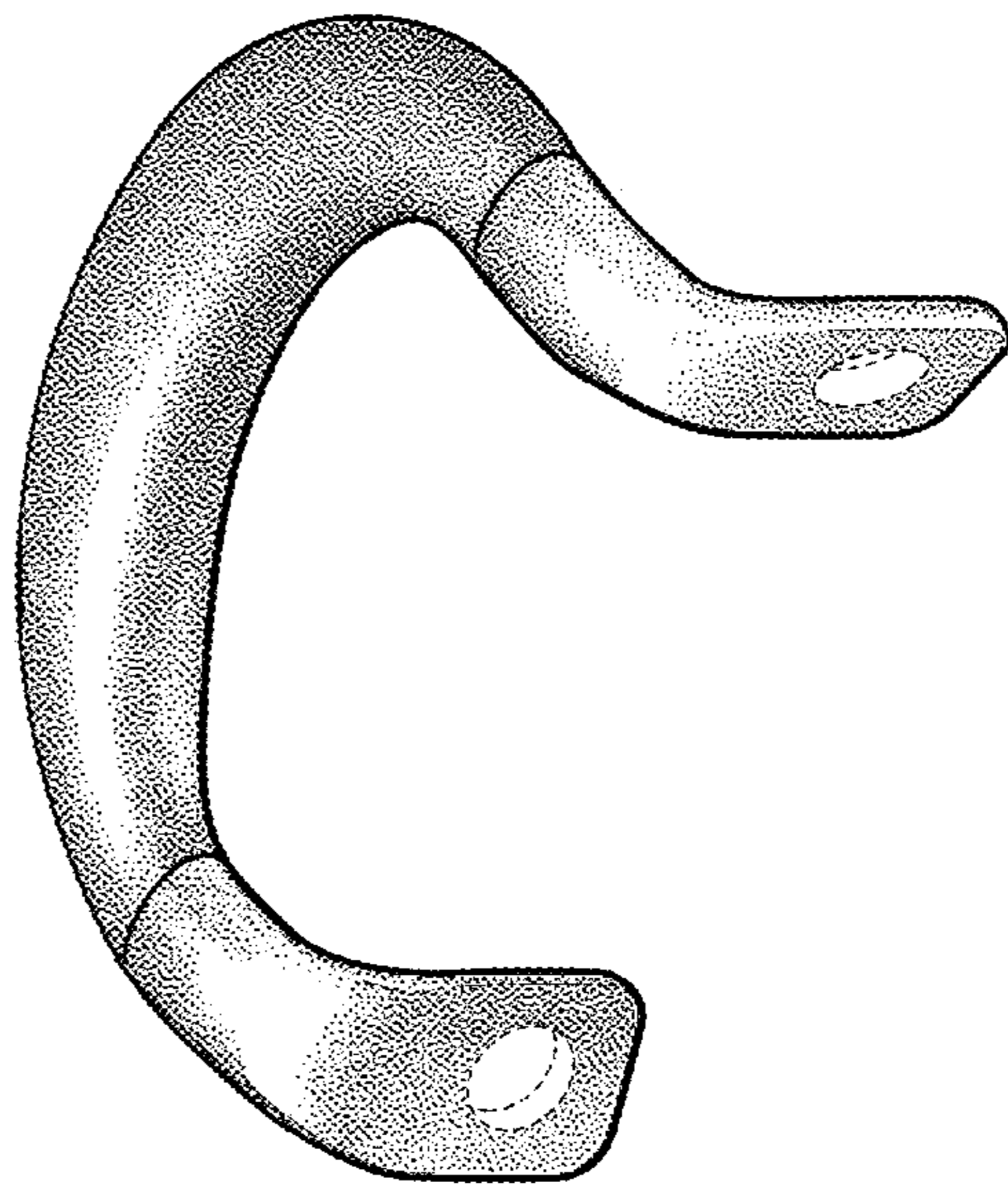

FIG. 20

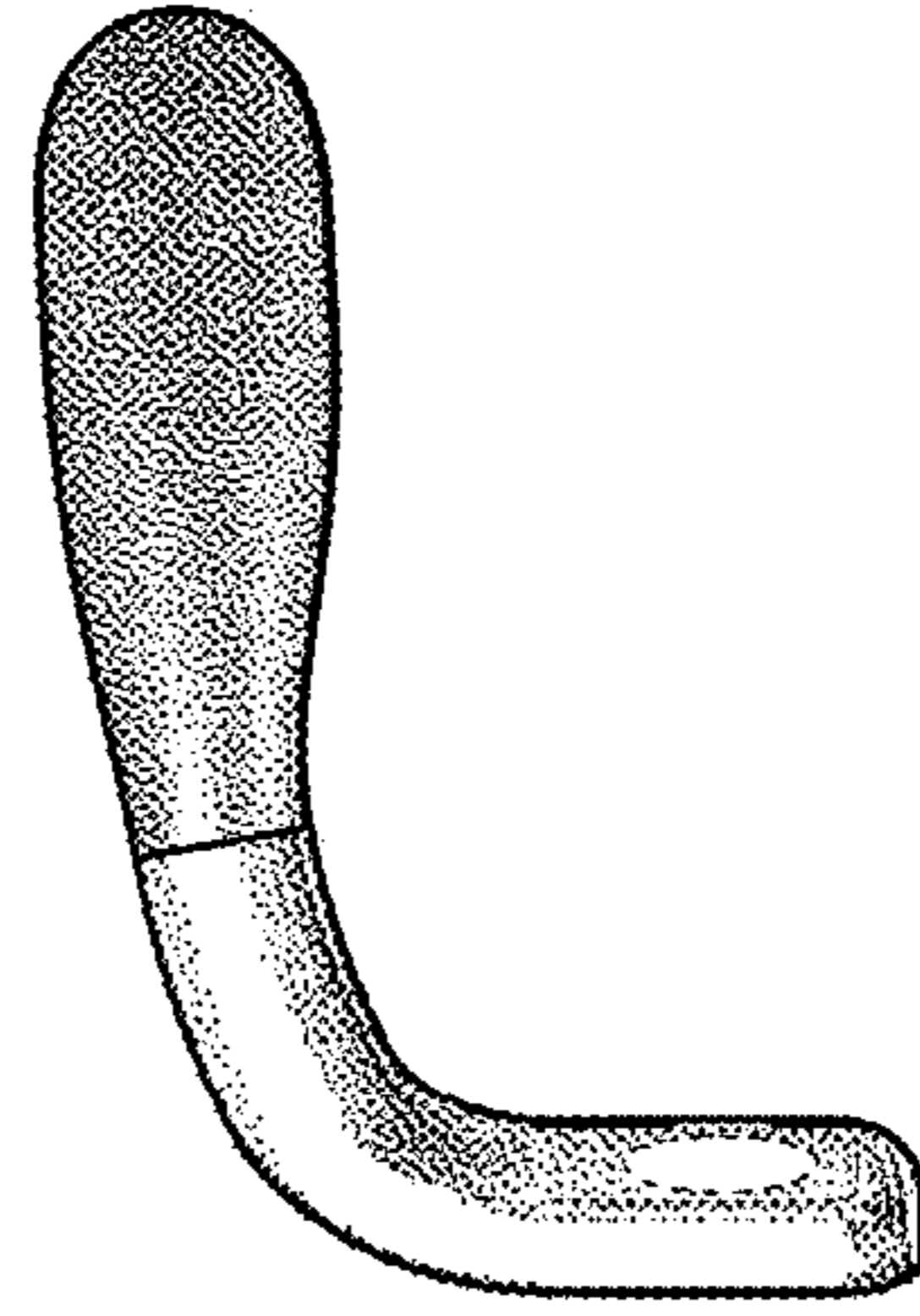

FIG. 21

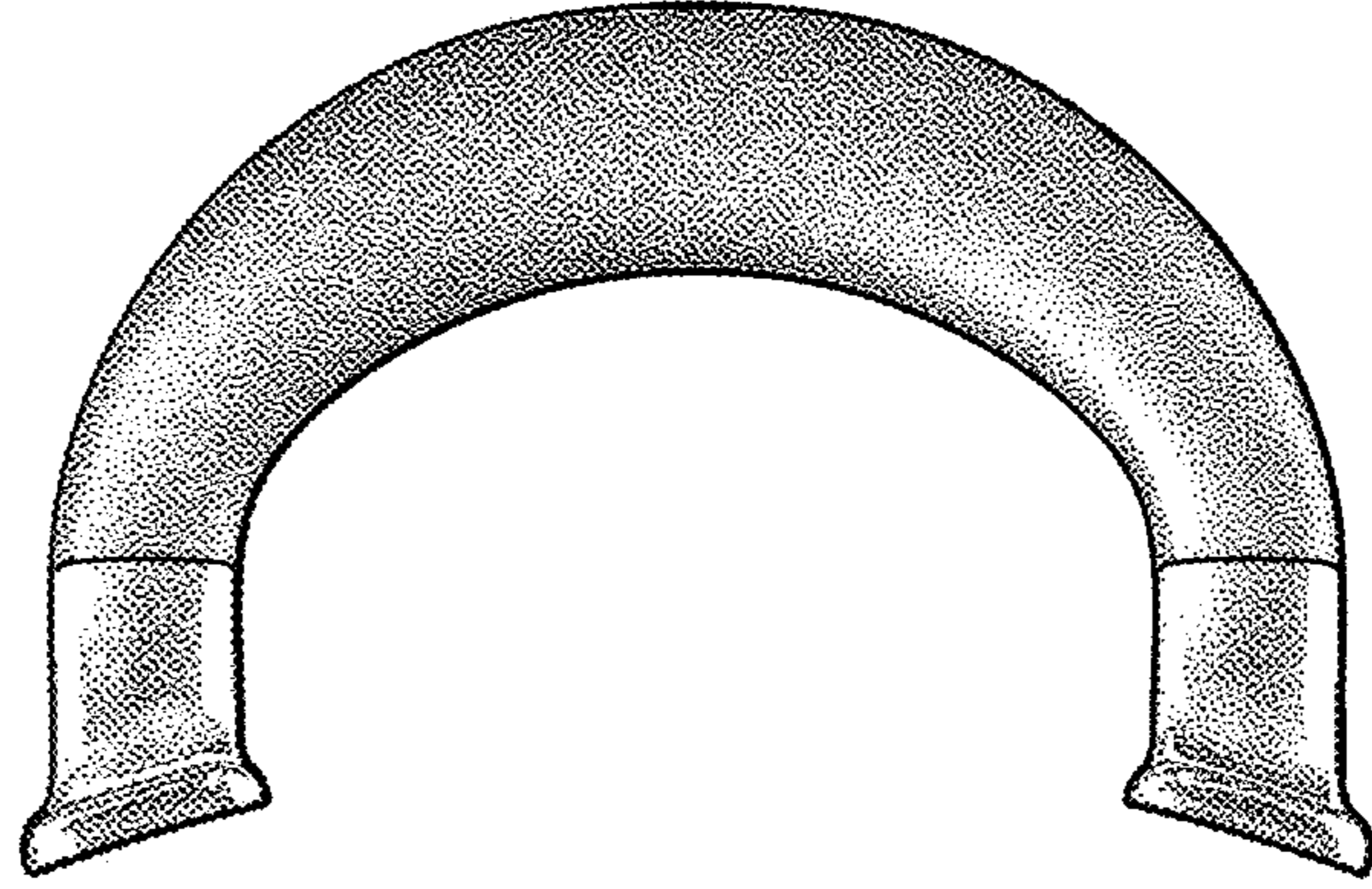

FIG. 23

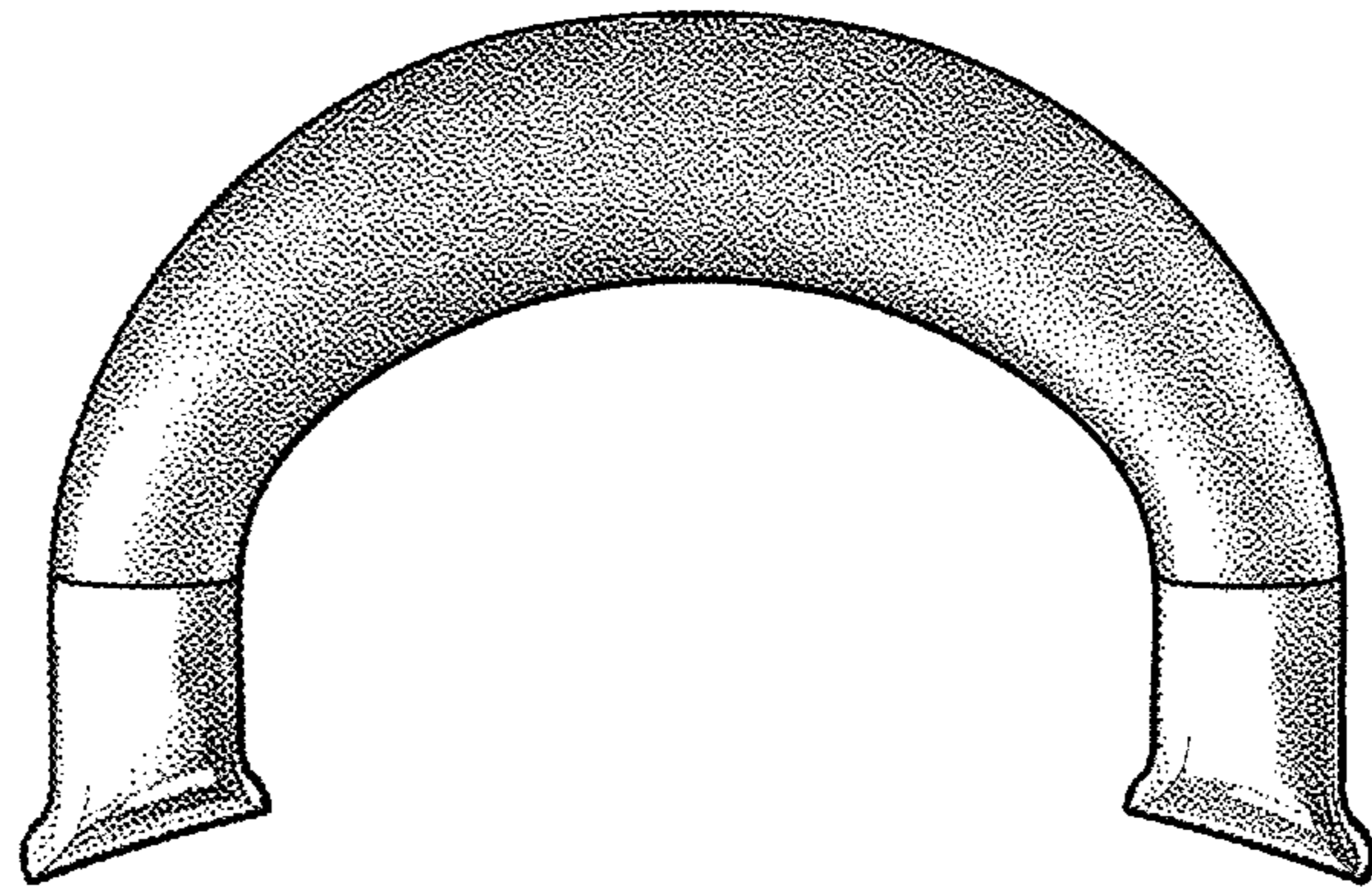

FIG. 22

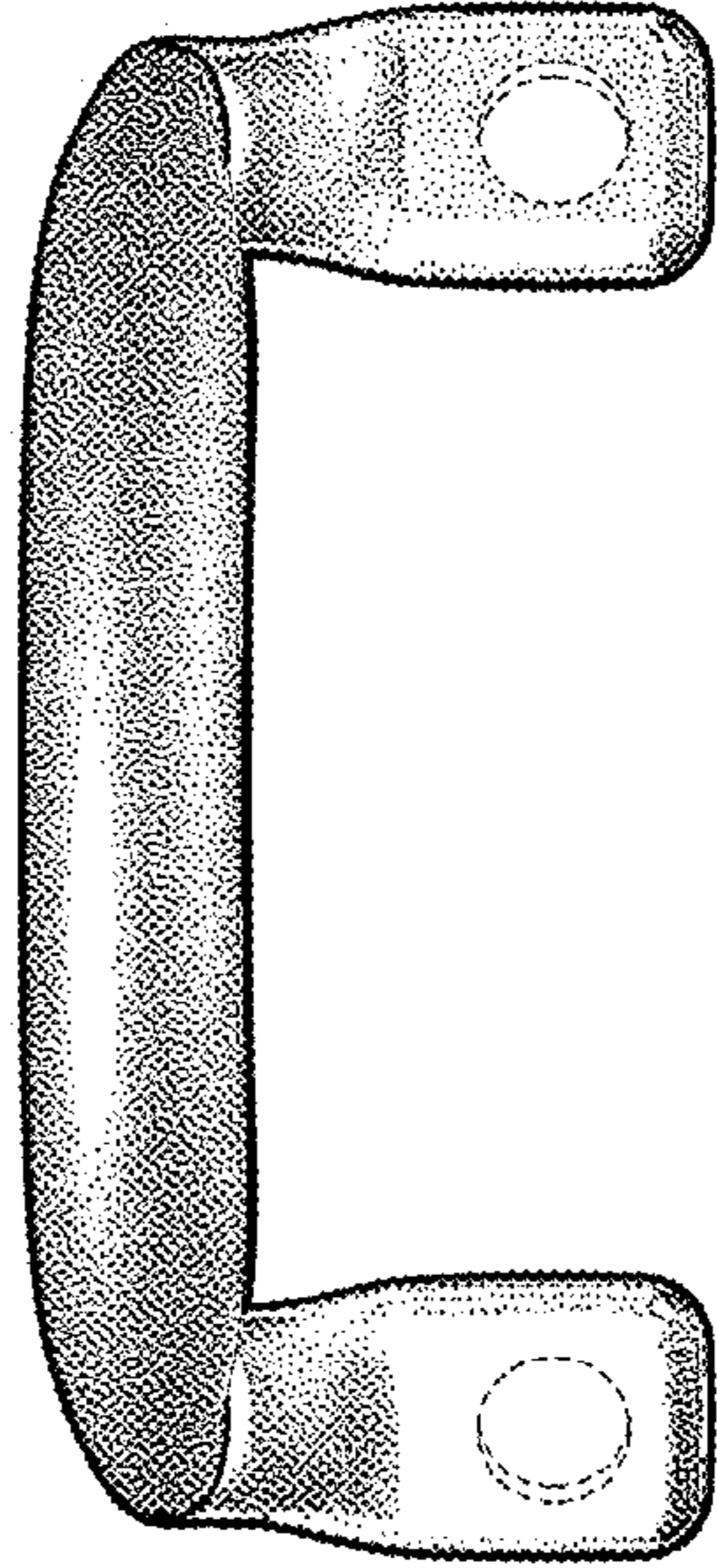

FIG. 25

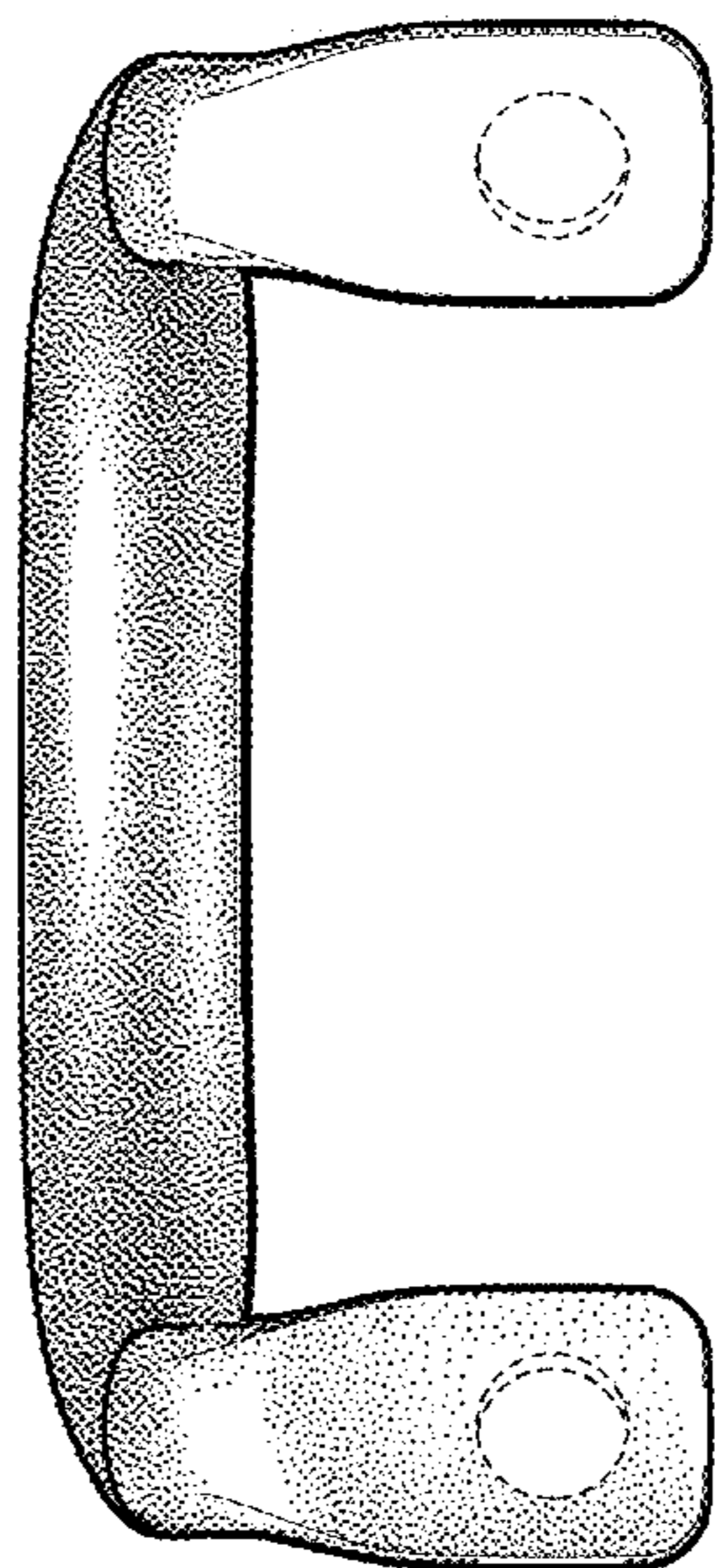

FIG. 24

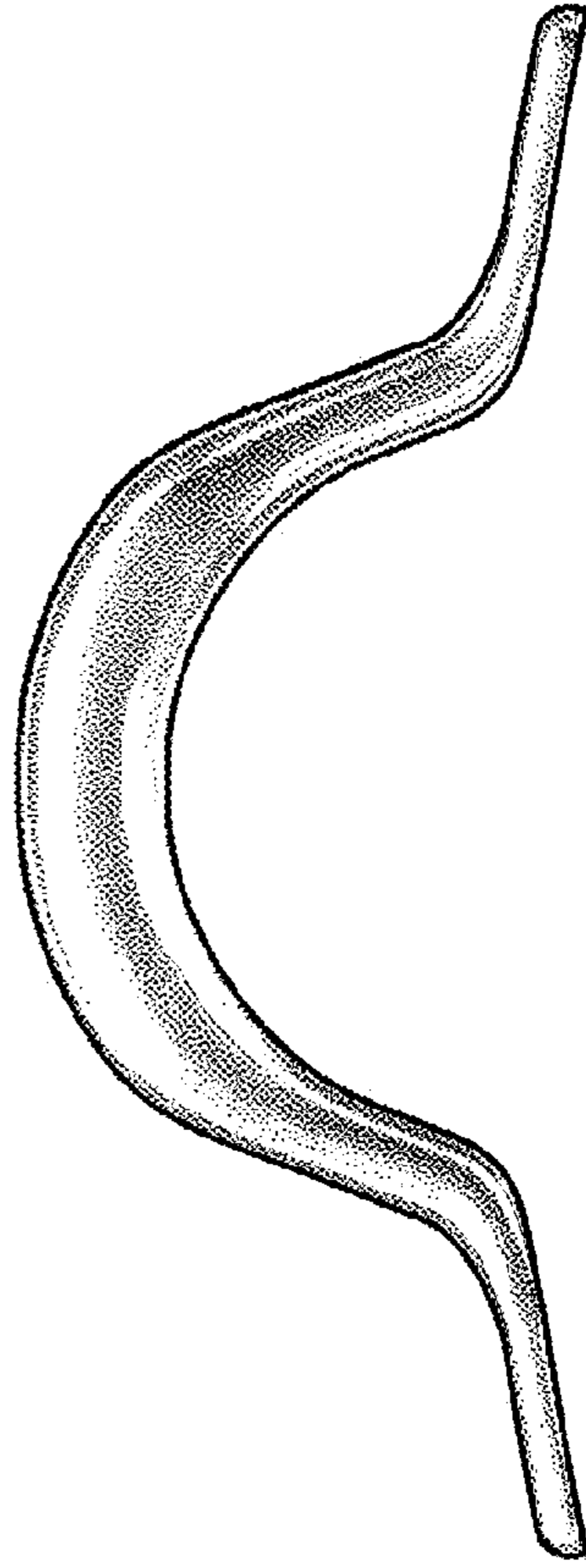

FIG. 27

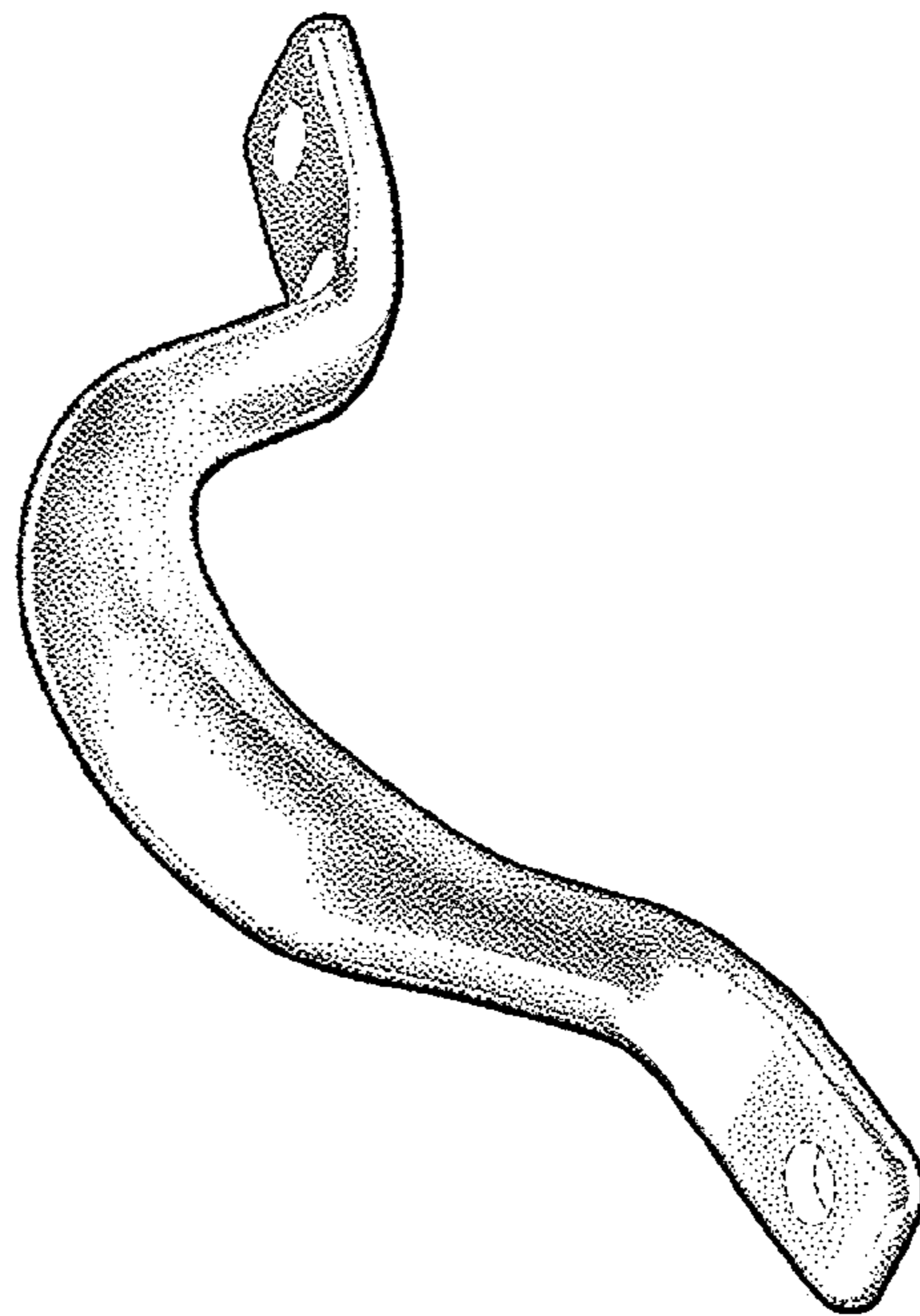

FIG. 26

FIG. 28

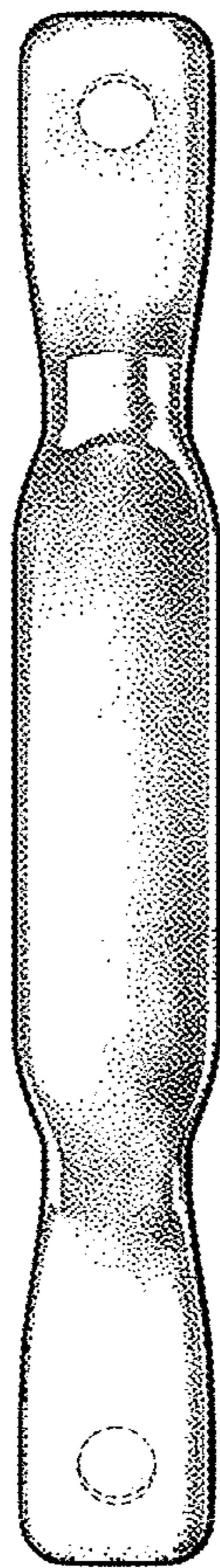
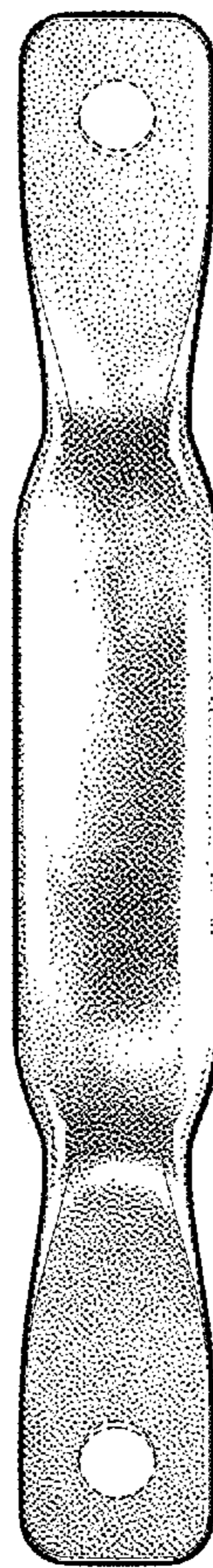

FIG. 29



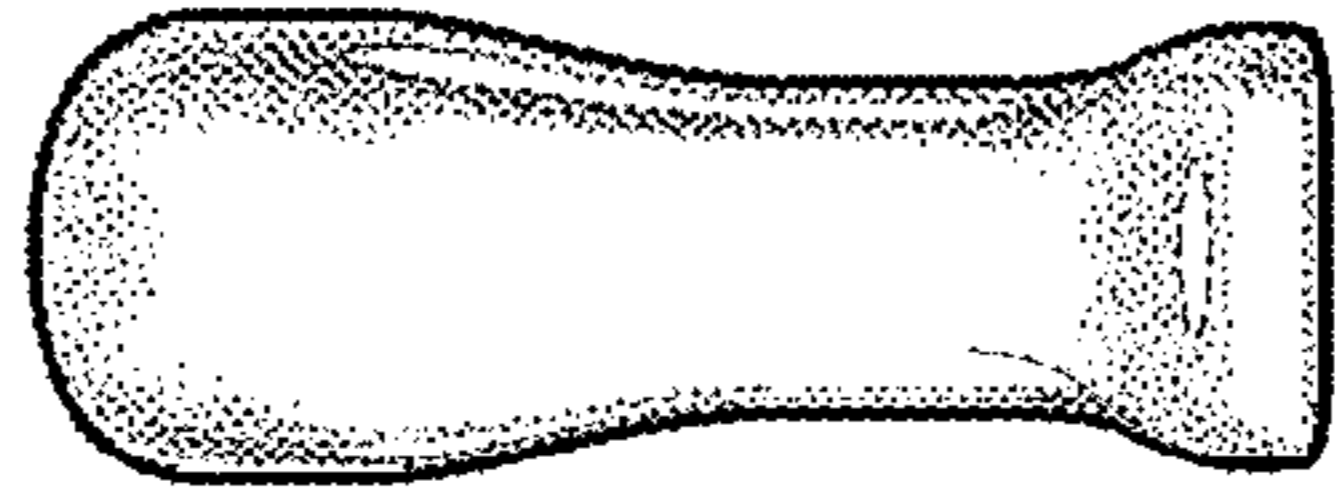

FIG. 30

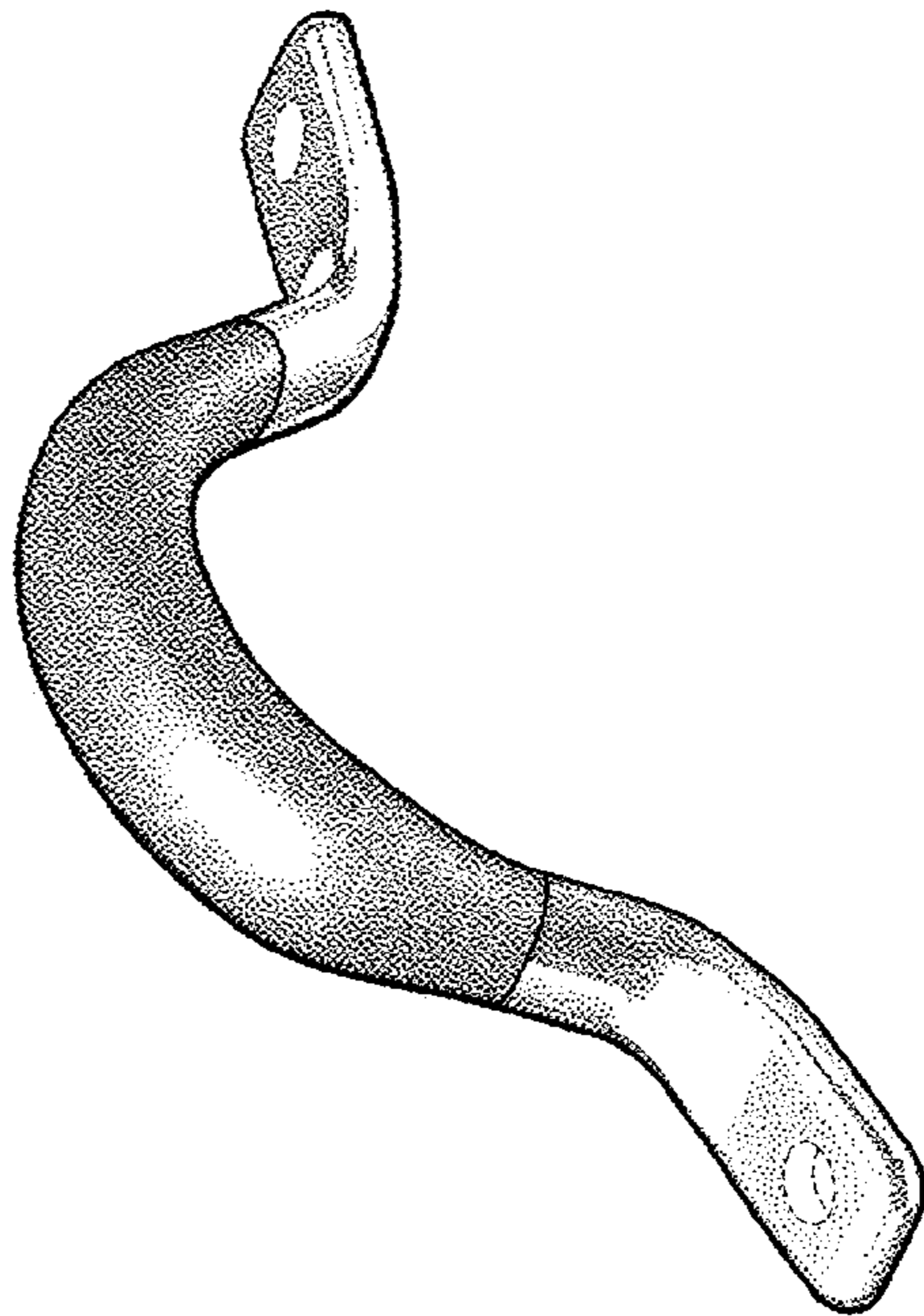

FIG. 31

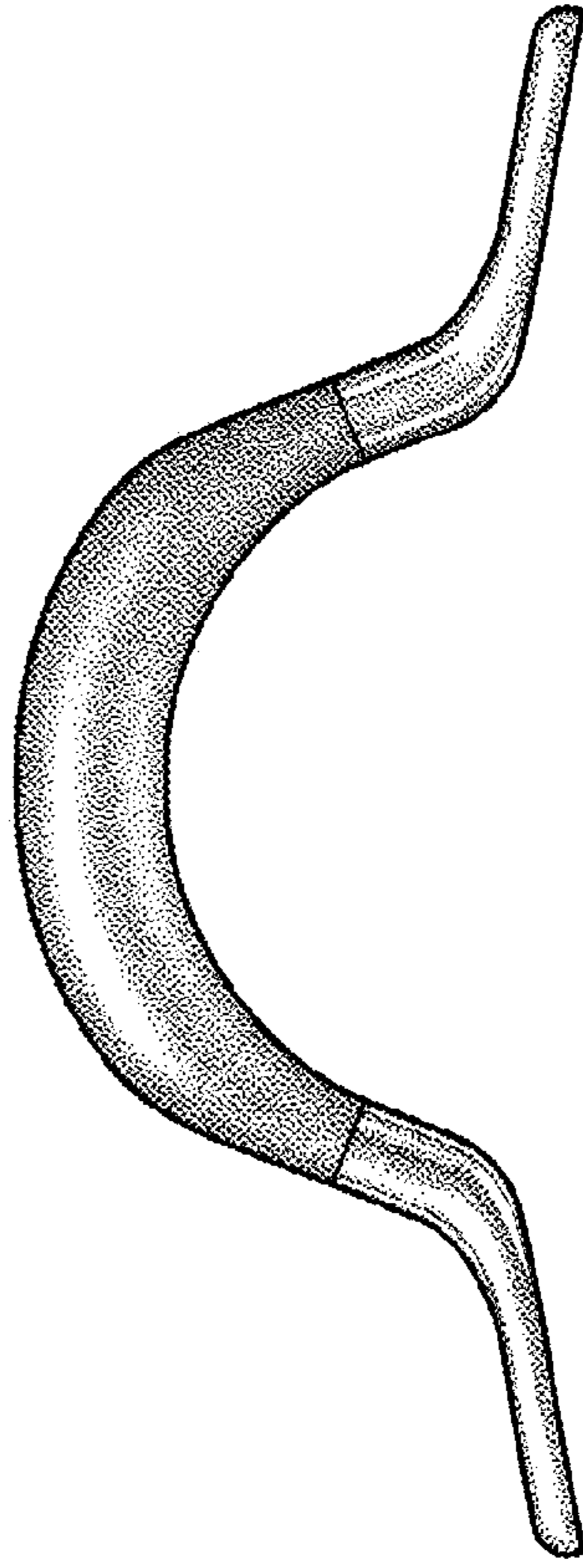

FIG. 32

FIG. 33

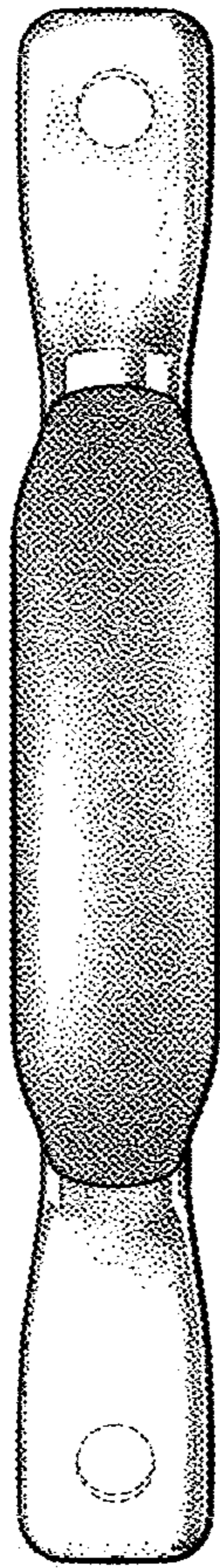

FIG. 34

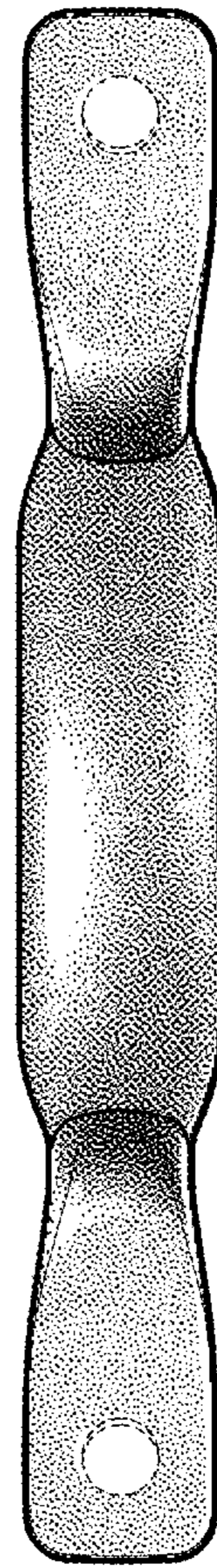

FIG. 35

