

US00D798652S

(12) **United States Design Patent** (10) **Patent No.:** **US D798,652 S**  
**Müller et al.** (45) **Date of Patent:** **\*\* Oct. 3, 2017**

(54) **STICK BLENDER**

*Primary Examiner* — Ricky Pham

(71) Applicant: **DE'LONGHI BRAUN HOUSEHOLD GMBH**, Neu-Isenburg (DE)

(74) *Attorney, Agent, or Firm* — Goodwin Procter LLP

(72) Inventors: **Dennis Müller**, Frankfurt am Main (DE); **Markus Orthey**, Eltville am Rhein (DE); **Britta Stockinger**, Frankfurt am Main (DE); **Sven Wuttig**, Griesheim (DE); **Duy P. Vu**, Schwalbach am Taunus (DE)

(57) **CLAIM**

The ornamental design for a stick blender, as shown and described.

(73) Assignee: **De'Longhi Braun Household GmbH**, Neu-Isenburg (DE)

**DESCRIPTION**

(\*\*) Term: **15 Years**

FIG. 1 is a top, front, and right side perspective view of a stick blender, in accordance with a first embodiment; FIG. 2 is an enlarged perspective view of a portion of the stick blender of FIG. 1; FIG. 3 is a front view of the stick blender of FIG. 1; FIG. 4 is a rear view of the stick blender of FIG. 1; FIG. 5 is a right side view of the stick blender of FIG. 1; FIG. 6 is a left side view of the stick blender of FIG. 1; FIG. 7 is a top view of the stick blender of FIG. 1; FIG. 8 is a bottom view of the stick blender of FIG. 1; FIG. 9 is a bottom, rear, and right side perspective view of the stick blender of FIG. 1; FIG. 10 is a top, front, and right side perspective view of a stick blender, in accordance with a second embodiment; FIG. 11 is an enlarged perspective view of a portion of the stick blender of FIG. 10; FIG. 12 is a front view of the stick blender of FIG. 10; FIG. 13 is a rear view of the stick blender of FIG. 10; FIG. 14 is a right side view of the stick blender of FIG. 10; FIG. 15 is a left side view of the stick blender of FIG. 10; FIG. 16 is a top view of the stick blender of FIG. 10; FIG. 17 is a bottom view of the stick blender of FIG. 10; and, FIG. 18 is a bottom, rear, and right side perspective view of the stick blender of FIG. 10.

(21) Appl. No.: **29/574,642**

(22) Filed: **Aug. 17, 2016**

(30) **Foreign Application Priority Data**

Feb. 18, 2016 (EM) ..... 002992453-0001  
Feb. 18, 2016 (EM) ..... 002992453-0002  
Feb. 18, 2016 (EM) ..... 002992453-0003  
Feb. 18, 2016 (EM) ..... 002992453-0004

(51) **LOC (10) Cl.** ..... **31-00**

(52) **U.S. Cl.**  
USPC ..... **D7/380; D7/376; D7/379**

(58) **Field of Classification Search**  
USPC ..... D7/372, 376-386, 412-413, 602, 629, D7/665-666, 669, 679, 693-694  
CPC .... A21C 1/02; A21C 1/04; A23N 1/00; A23N 1/02; A47J 43/04; A47J 43/25; A47J 43/27; A47J 43/042; A47J 43/044; A47J 43/046;

(Continued)

(56) **References Cited**

U.S. PATENT DOCUMENTS

D383,938 S \* 9/1997 Littmann ..... D7/376  
D394,367 S \* 5/1998 Littmann ..... D7/376

(Continued)

**1 Claim, 10 Drawing Sheets**

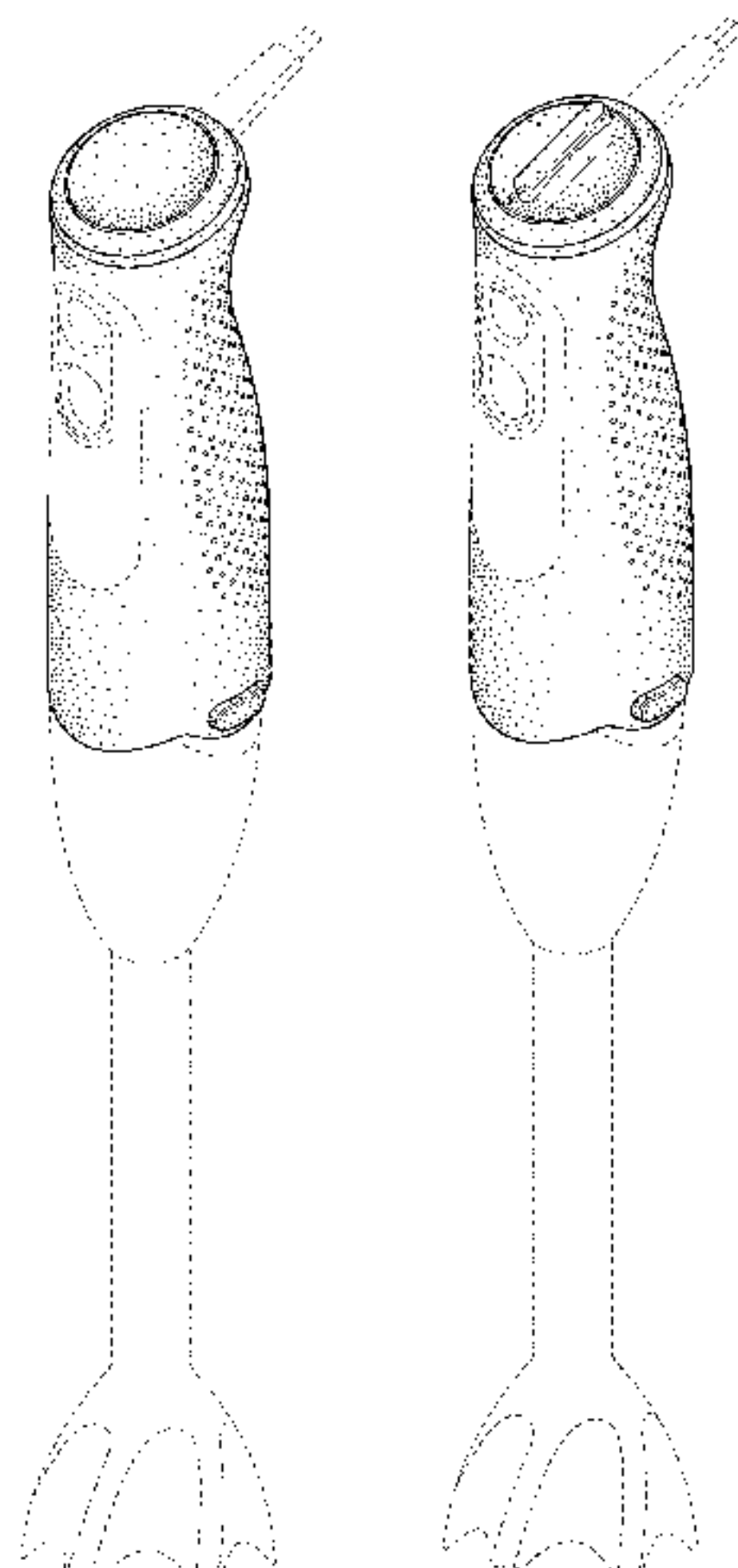

(58) **Field of Classification Search**

CPC .. A47J 43/075; A47J 43/0711; A47J 43/0722;  
A47J 43/0727; B01F 3/00; B01F 3/0807;  
B01F 3/0853; B01F 13/0059; B01F  
13/0064; B02C 1/08; B02C 2/04; B02C  
4/42; B02C 4/142; B02C 4/143; B02C  
4/423; B02C 13/1835; B28C 5/10; B28C  
5/12; B28C 5/14; B28C 5/16

See application file for complete search history.

(56) **References Cited**

U.S. PATENT DOCUMENTS

D426,105	S	*	6/2000	Littmann	.....	D7/376
D506,102	S	*	6/2005	Ikegaki	.....	D7/376
D510,837	S	*	10/2005	Lloyd	.....	D7/376
D649,394	S	*	11/2011	Grabes	.....	D7/376
D651,041	S	*	12/2011	Bachmann	.....	D7/376
D662,765	S	*	7/2012	Grabes	.....	D7/376
D667,682	S	*	9/2012	Agren	.....	D7/376
D668,911	S	*	10/2012	Bachmann	.....	D7/376
D681,391	S	*	5/2013	Agren	.....	D7/376
D726,496	S	*	4/2015	Vu	.....	D7/376
2005/0078549	A1	*	4/2005	Hamelin	..... A47J 43/0711	366/129

\* cited by examiner

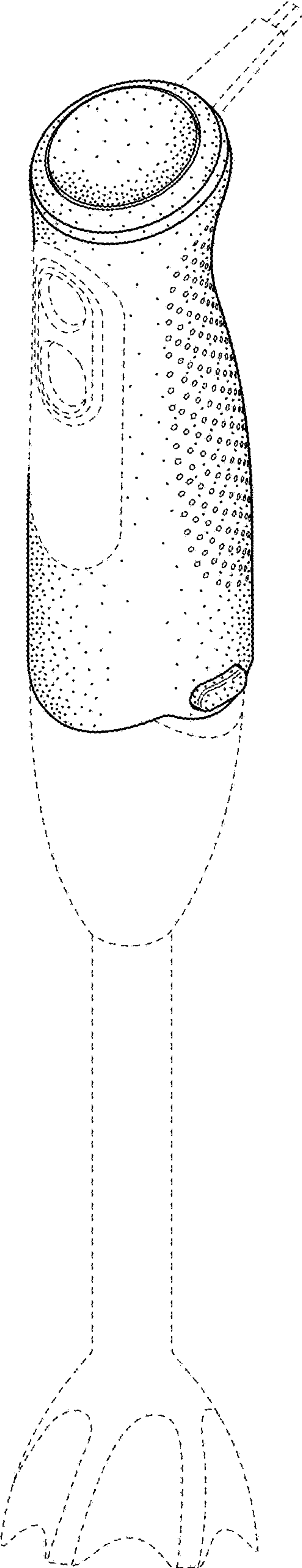

FIG. 1

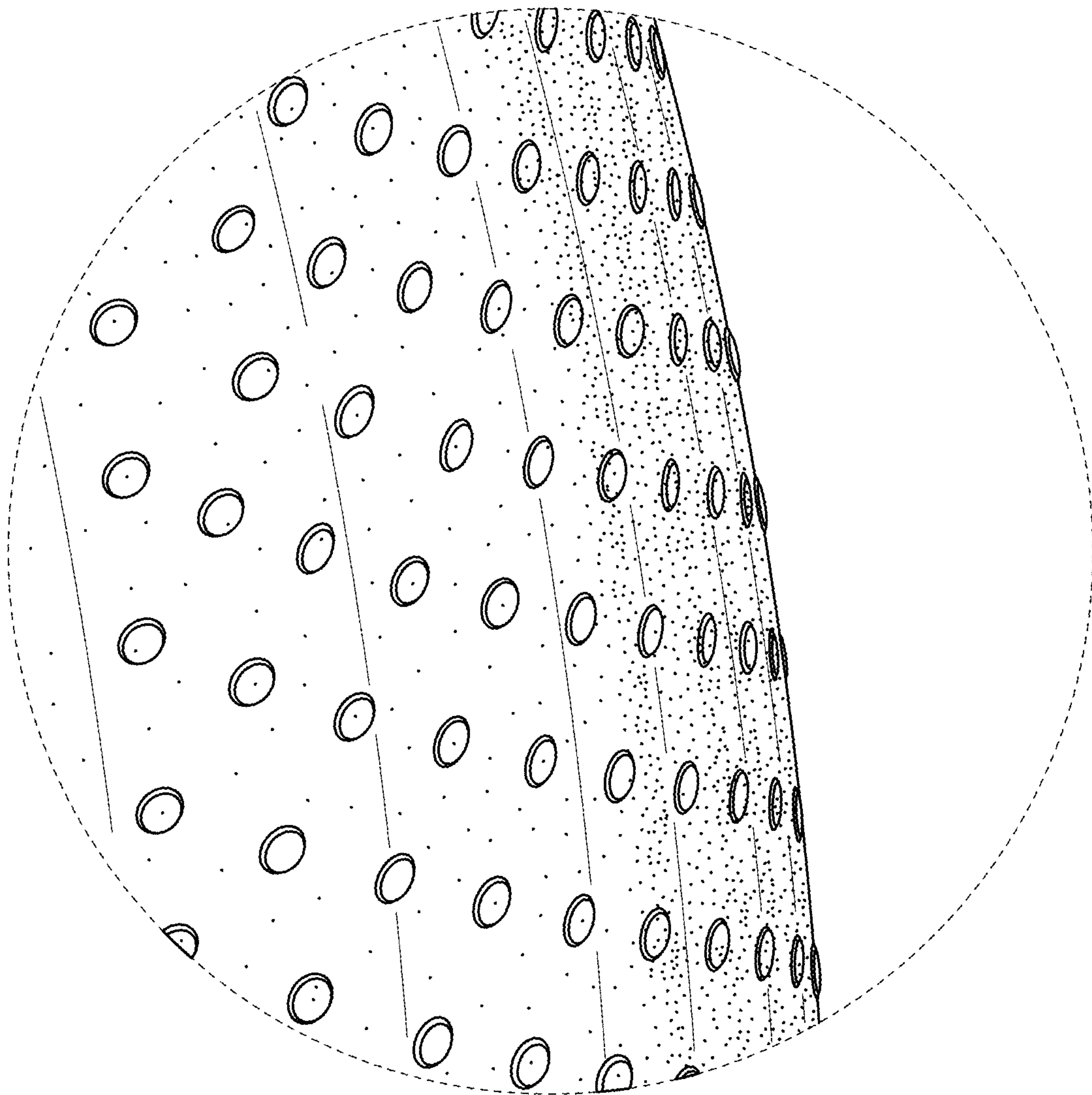

FIG. 2



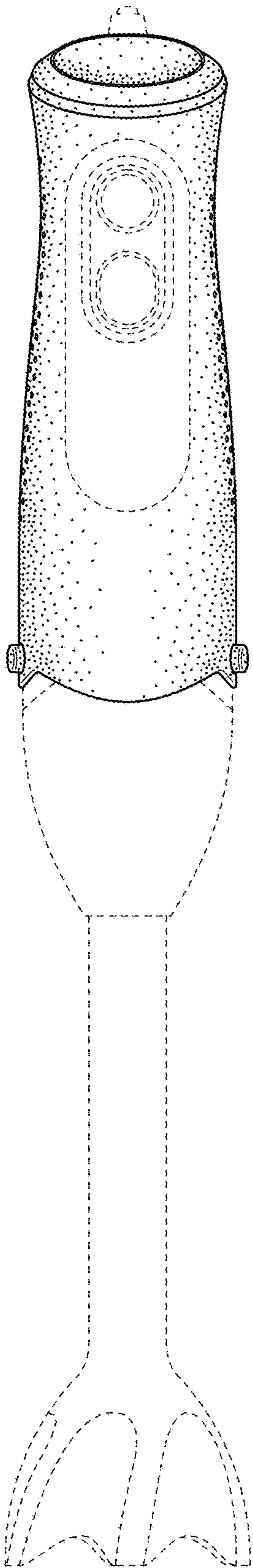

FIG. 3

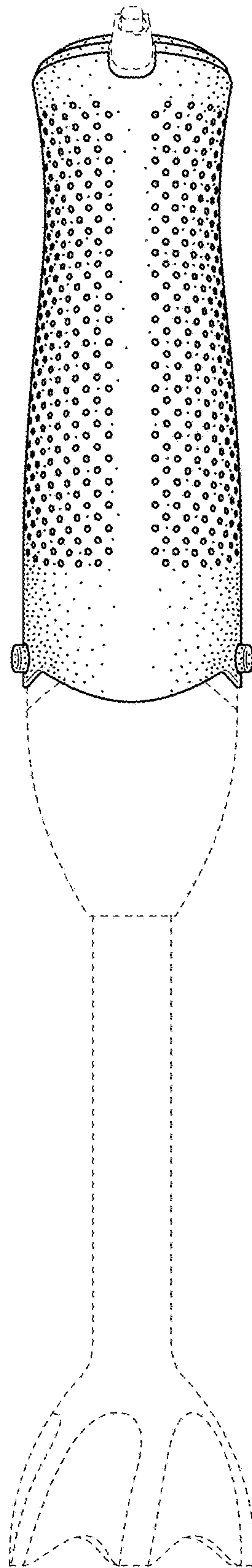

FIG. 4

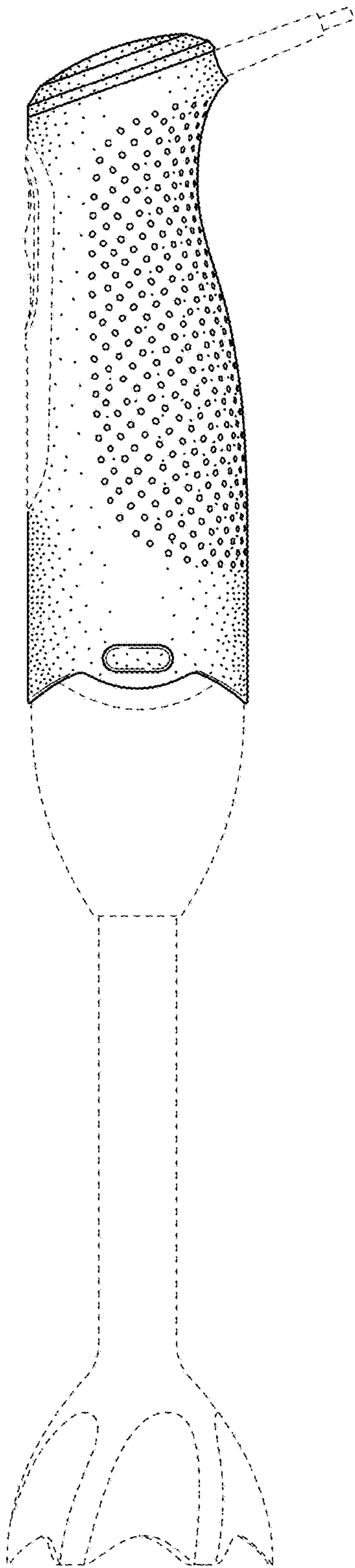

FIG. 5

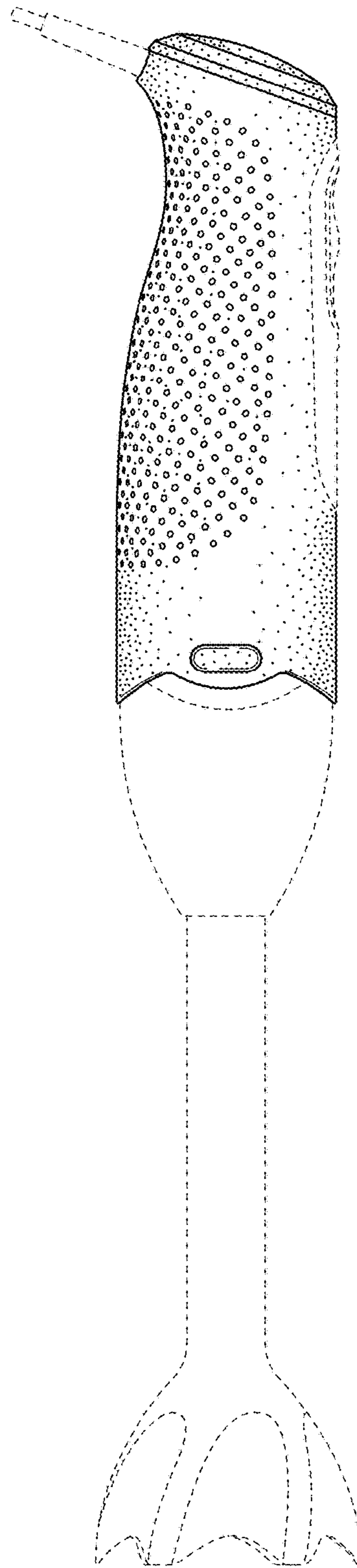

FIG. 6

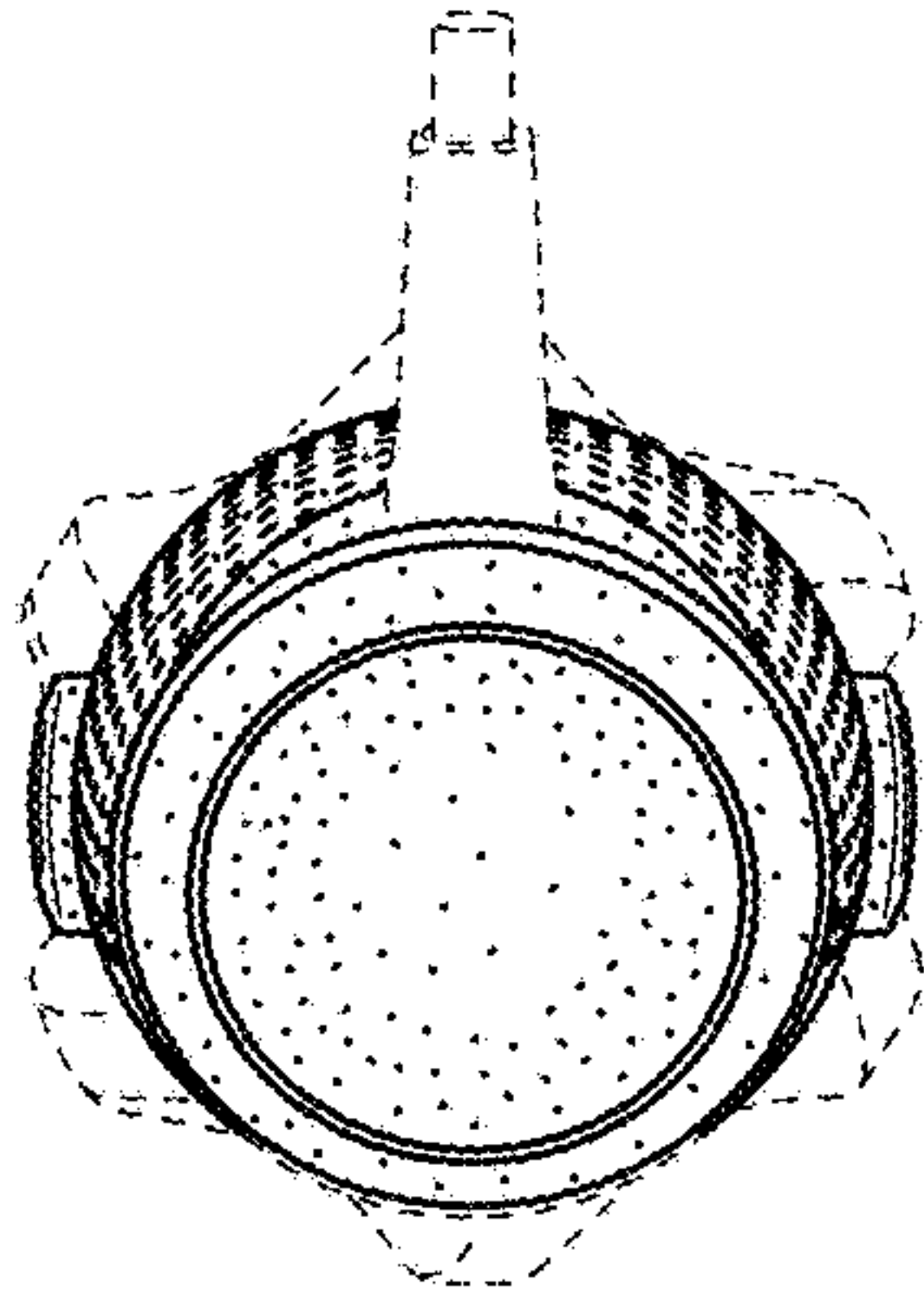

FIG. 7

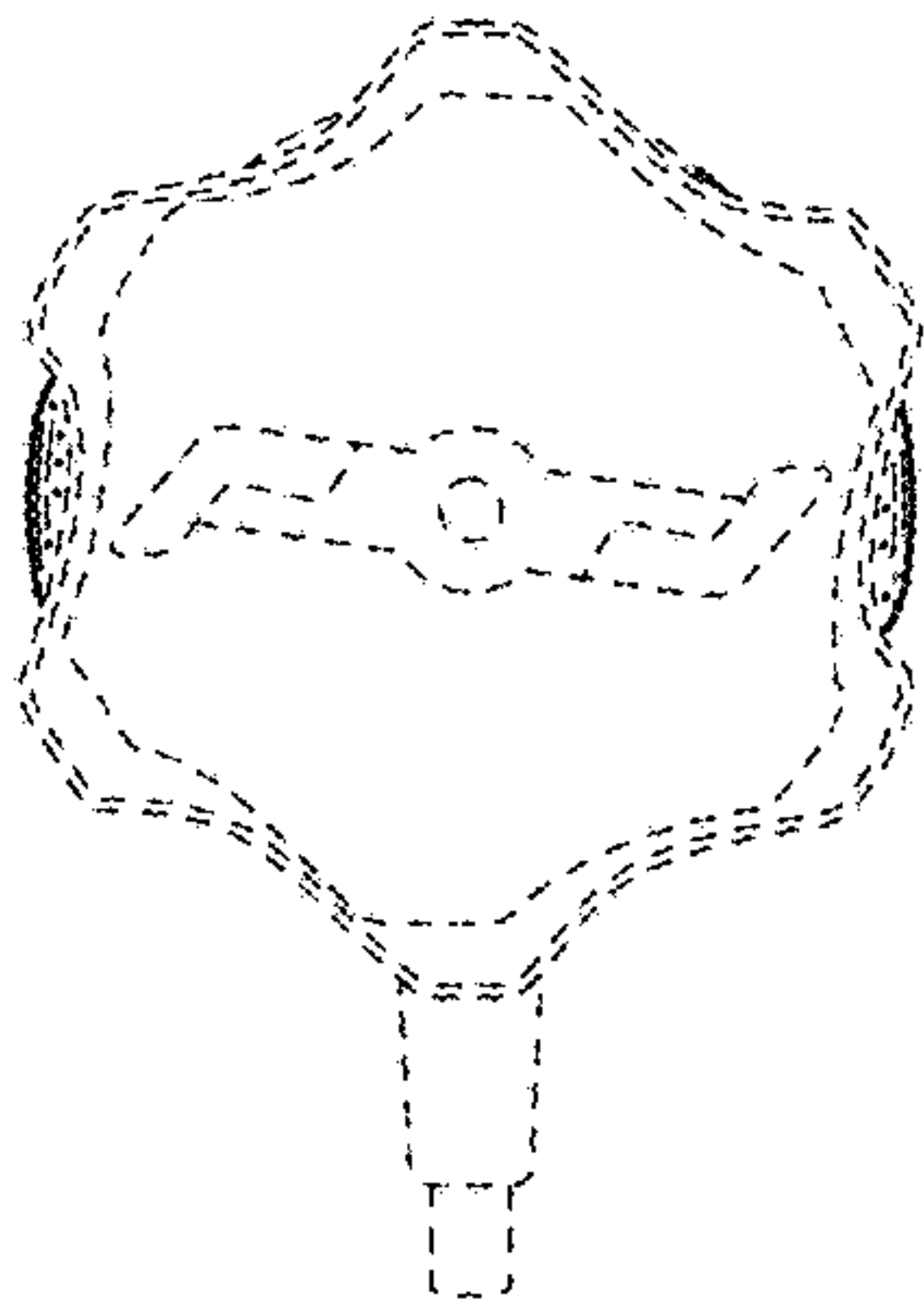

FIG. 8

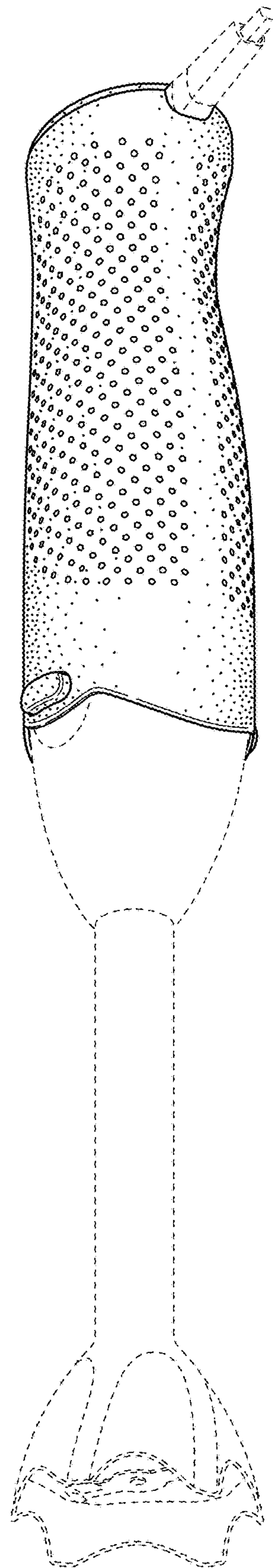

FIG. 9

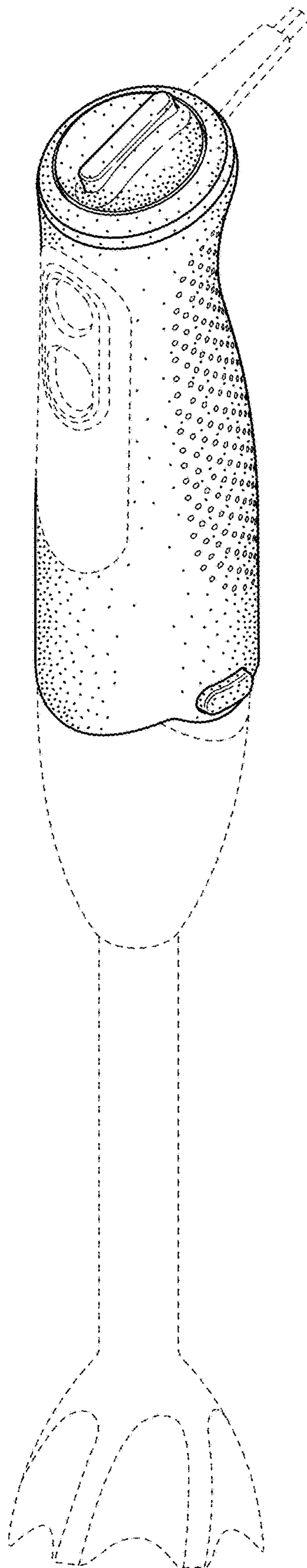

FIG. 10



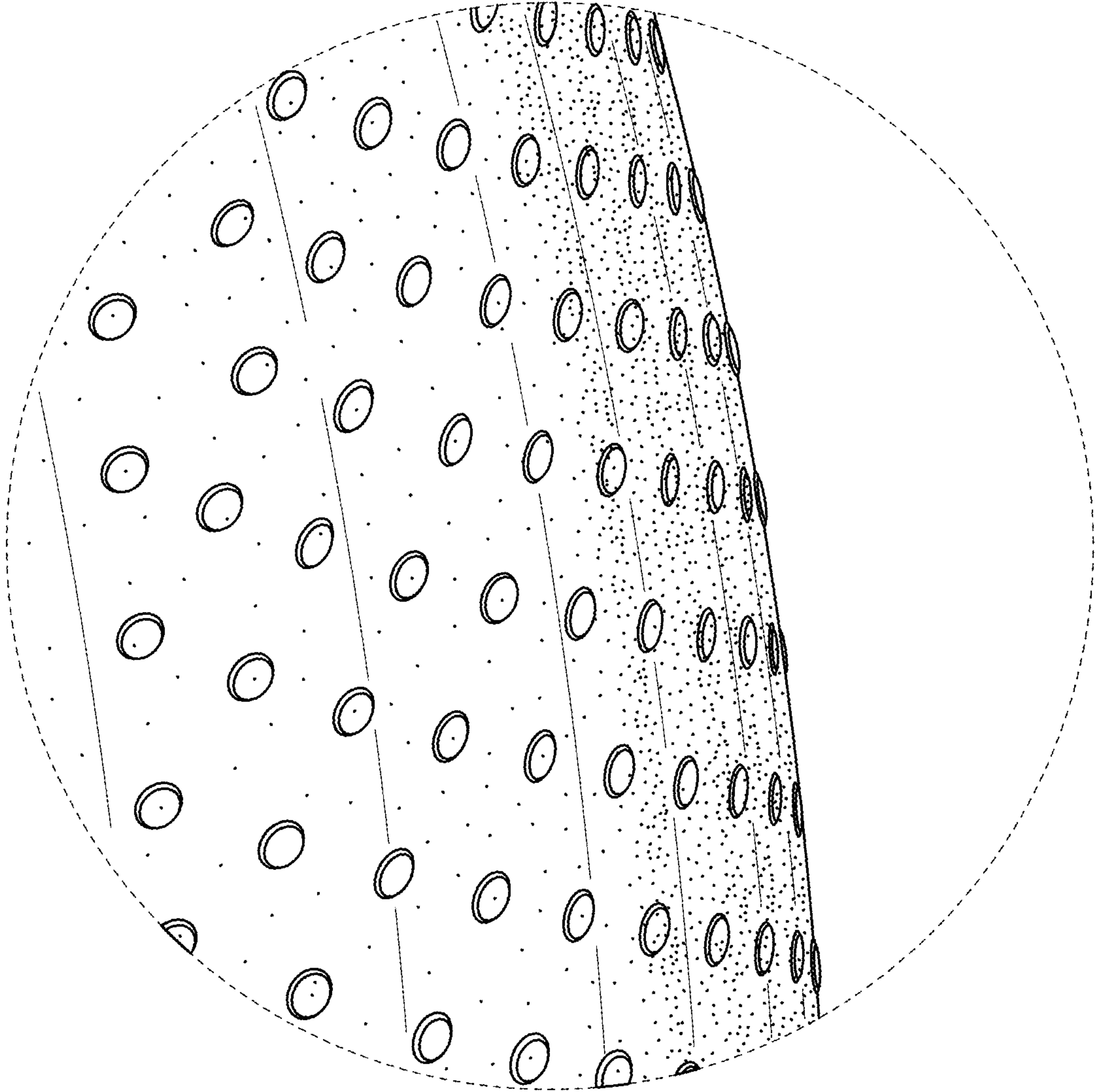

FIG. 11

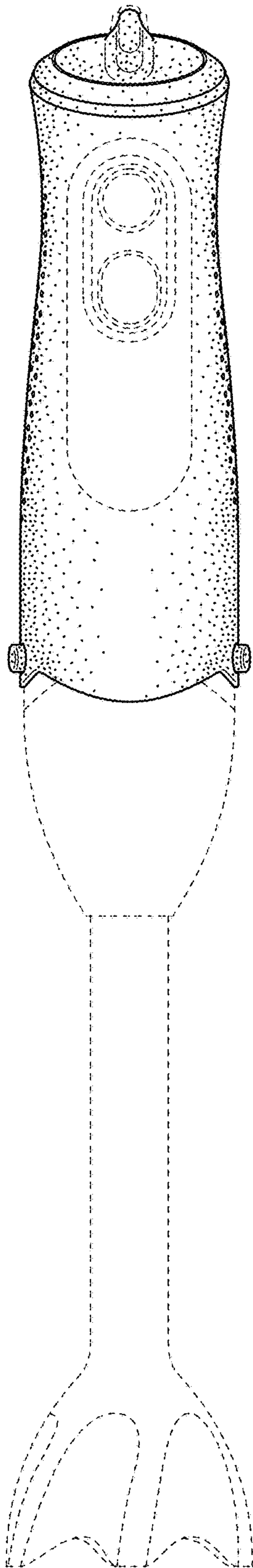

FIG. 12

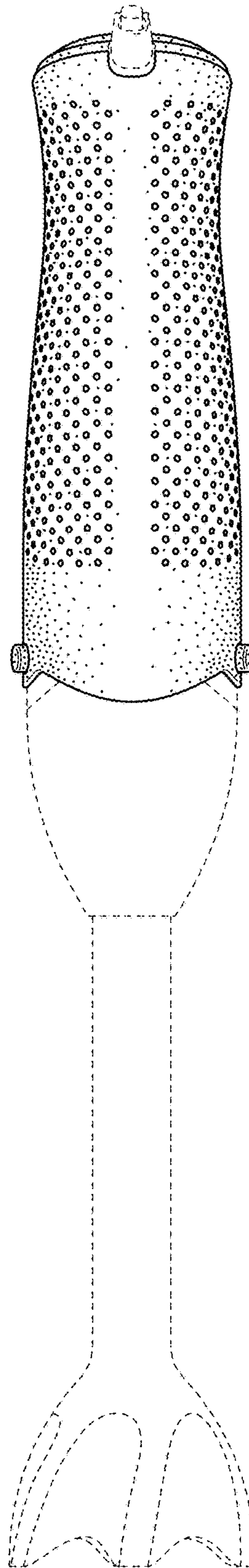

FIG. 13

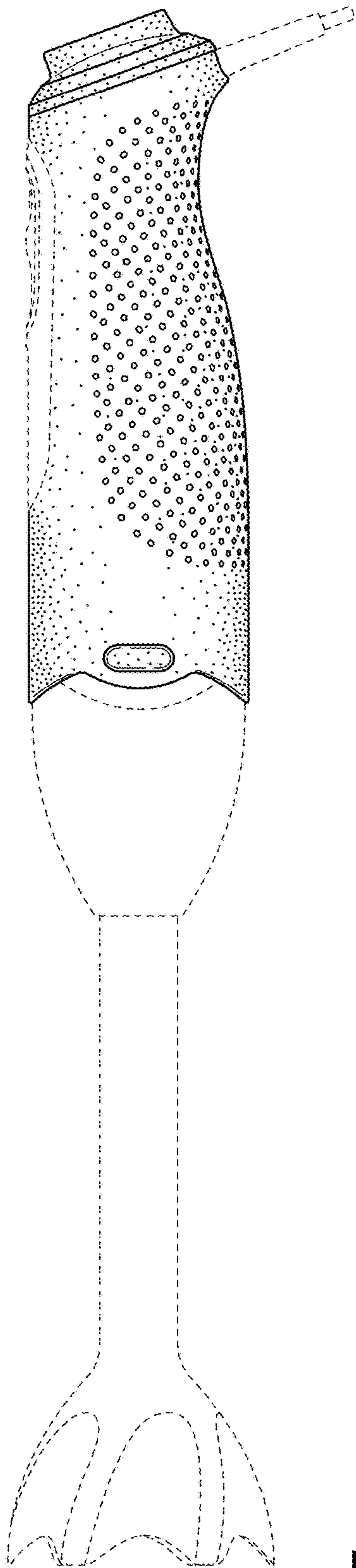

FIG. 14

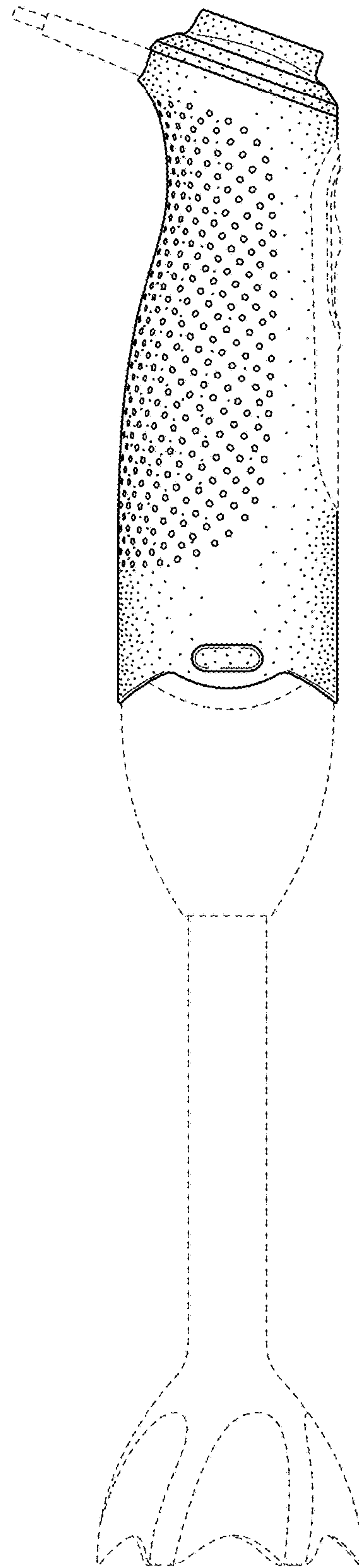

FIG. 15

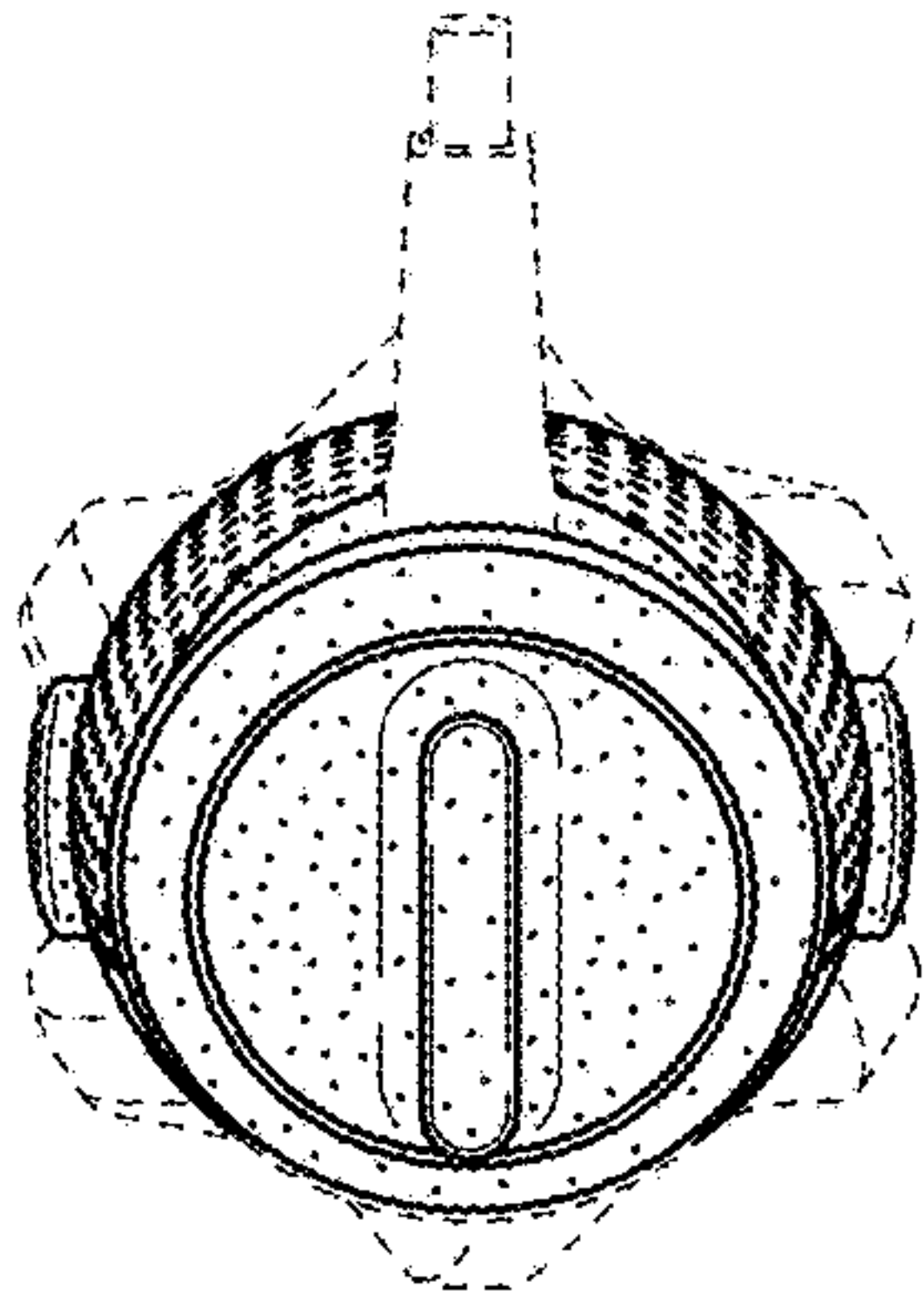

FIG. 16

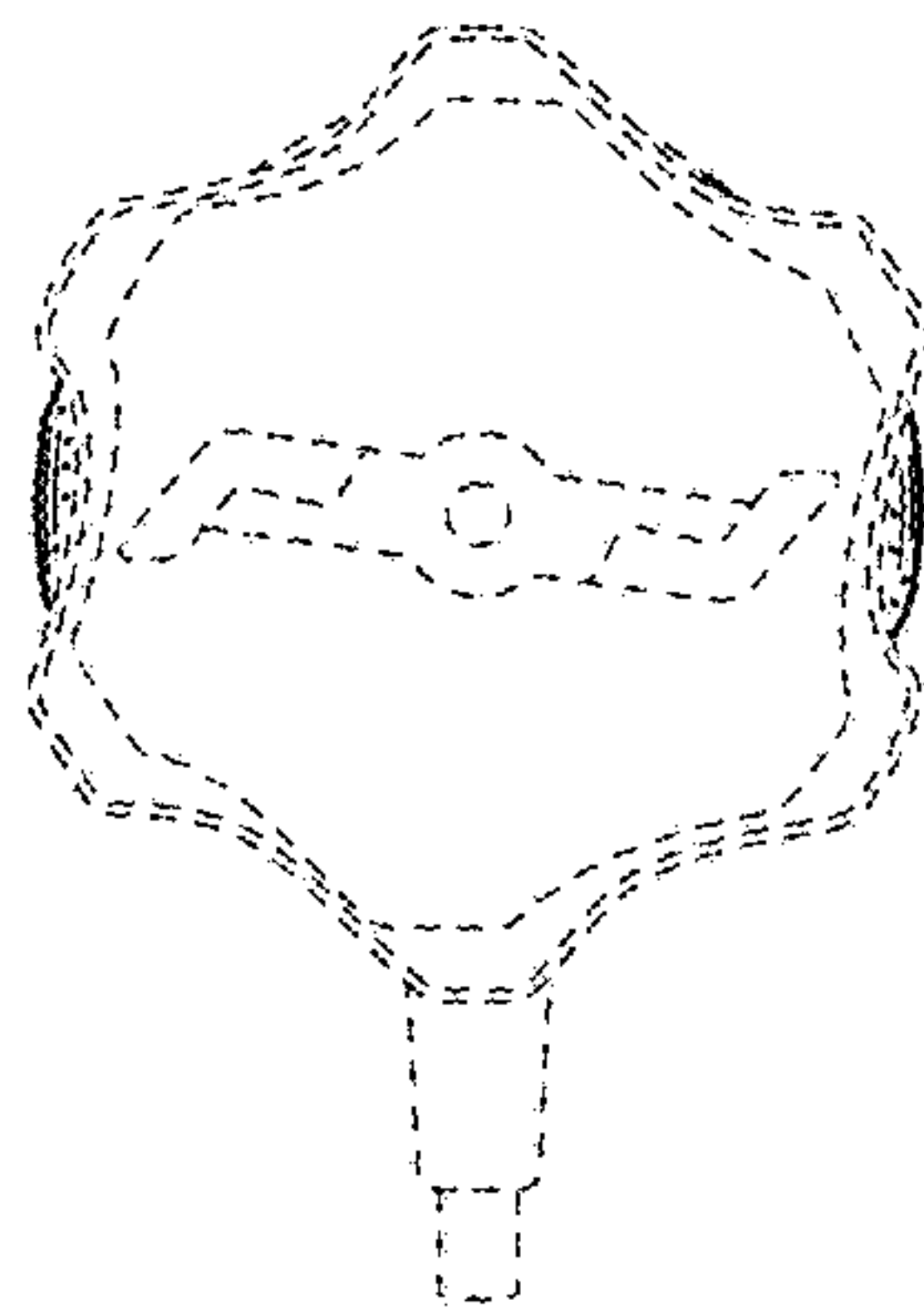

FIG. 17

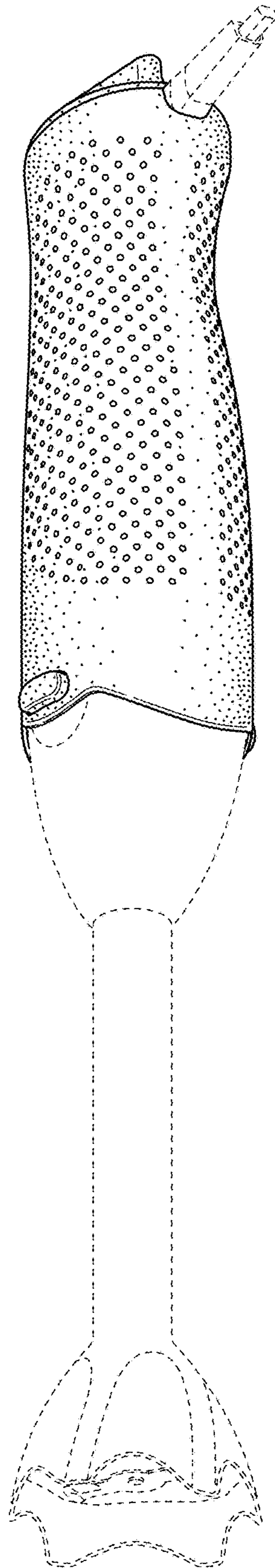

FIG. 18