



US00D798620S

(12) **United States Design Patent** (10) **Patent No.:** **US D798,620 S**  
**Liu** (45) **Date of Patent:** **\*\* Oct. 3, 2017**

(54) **INFLATABLE ANIMAL-SHAPED ROCKING CHAIR**

(71) Applicant: **BESTWAY INFLATABLES & MATERIAL CORP.**, Shanghai (CN)

(72) Inventor: **Feng Liu**, Shanghai (CN)

(73) Assignee: **BESTWAY INFLATABLES & MATERIAL CORP.**, Shanghai (CN)

(\*\*) Term: **15 Years**

(21) Appl. No.: **29/571,783**

(22) Filed: **Jul. 21, 2016**

(30) **Foreign Application Priority Data**

Apr. 28, 2016 (CN) ..... 2016 3 0150976

(51) **LOC (10) Cl.** ..... **06-01**

(52) **U.S. Cl.**  
USPC ..... **D6/345**

(58) **Field of Classification Search**  
USPC ..... D6/334, 344, 345, 348, 358, 368-371, D6/373, 381, 708, 364; D21/412-417, D21/420, 620, 808, 814, 828, 830-832; D14/356, 388  
CPC ..... A63H 23/00; A63H 23/10; A63H 3/06; A63G 31/12; A63G 31/007; A63G 19/00; A63G 19/18; A63G 21/18; A47C 3/029; A47C 15/008; A47C 27/081; B63B 35/73; B63B 35/74; B63C 9/08; E04H 4/0025; G06F 3/011

See application file for complete search history.

(56) **References Cited**

**U.S. PATENT DOCUMENTS**

1,851,768 A 3/1932 Hubbell  
2,404,729 A \* 7/1946 Hurt ..... B63B 35/74  
441/130

2,423,890 A \* 7/1947 Hurt ..... A47C 27/081  
141/313  
D155,253 S \* 9/1949 Wolf ..... D21/417  
D162,126 S \* 2/1951 Burkes ..... D21/620  
D165,202 S \* 11/1951 Wendt ..... D21/420  
2,665,519 A 1/1954 Burkes  
2,688,207 A 9/1954 Hurt  
4,023,816 A \* 5/1977 Ellman ..... A63G 19/00  
280/1.13  
4,099,773 A 7/1978 Chang  
4,336,931 A 6/1982 van Staden  
D270,587 S \* 9/1983 O'Connell ..... D21/417  
D272,838 S \* 2/1984 O'Connell ..... D21/417  
D295,427 S \* 4/1988 Vullierme ..... D21/416  
D333,326 S 2/1993 Lee

(Continued)

**OTHER PUBLICATIONS**

“Jet Creations Inflatable Blue Rocking Horse” Sep. 20, 2012, flickr.com, site visited Jul. 12, 2017 <<https://www.flickr.com/photos/65237805@N02/8007574197>>.\*

*Primary Examiner* — Kevin Rudzinski

*Assistant Examiner* — Paul Bohannon

(74) *Attorney, Agent, or Firm* — Birch, Stewart, Kolasch & Birch, LLP

(57) **CLAIM**

The ornamental design for an inflatable animal-shaped rocking chair, as shown and described.

**DESCRIPTION**

FIG. 1 is a front perspective view of an inflatable animal-shaped rocking chair showing my new design; FIG. 2 is a left side elevational view thereof; FIG. 3 is a right side elevational view thereof; FIG. 4 is a front side elevational thereof; FIG. 5 is a rear side elevational view thereof; FIG. 6 is a top plan view thereof; and, FIG. 7 is a bottom view thereof.

**1 Claim, 7 Drawing Sheets**

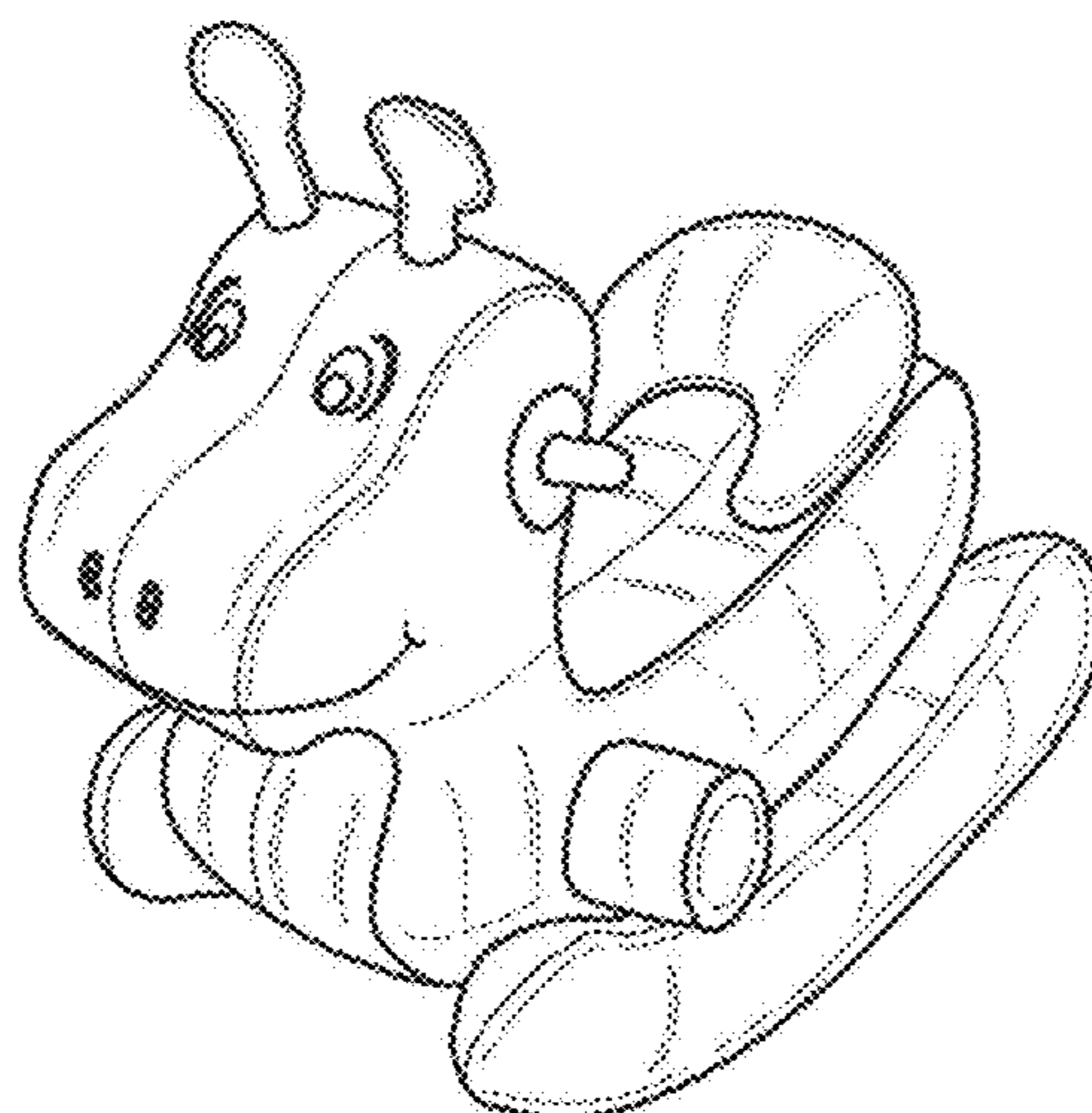

(56)

**References Cited**

U.S. PATENT DOCUMENTS

6,039,327	A *	3/2000	Spector .....	A63G 19/18 280/1.13
D541,889	S *	5/2007	Olson .....	D21/416
D542,861	S *	5/2007	Boufin .....	D21/417
D785,119	S *	4/2017	Hempton .....	D21/808
D789,368	S *	6/2017	Goetgeluk .....	G06F 3/011 D14/356
2008/0119107	A1	5/2008	Song et al.	
2013/0318703	A1 *	12/2013	Berenson .....	A63G 21/18 4/494

\* cited by examiner

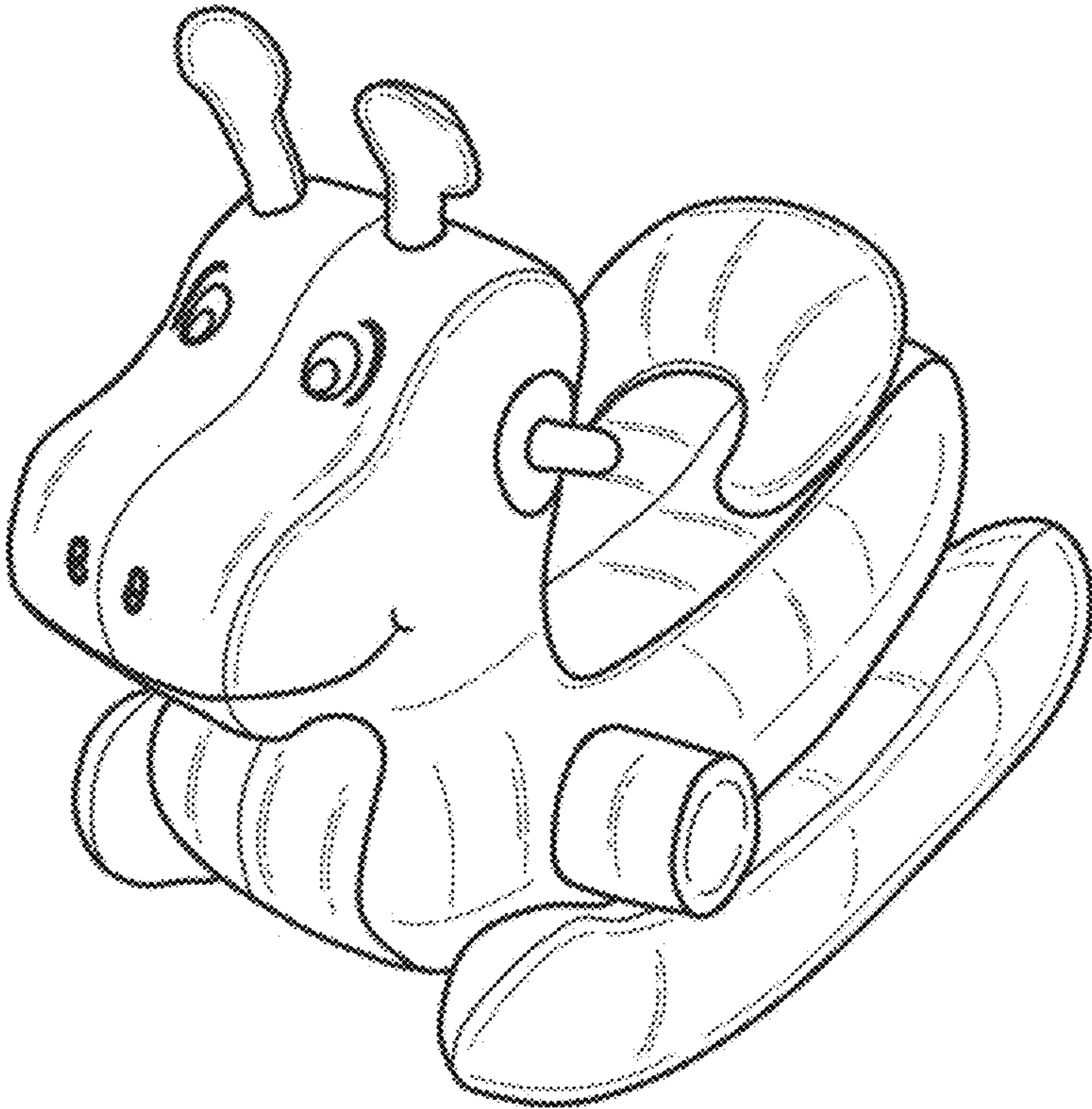

Fig. 1

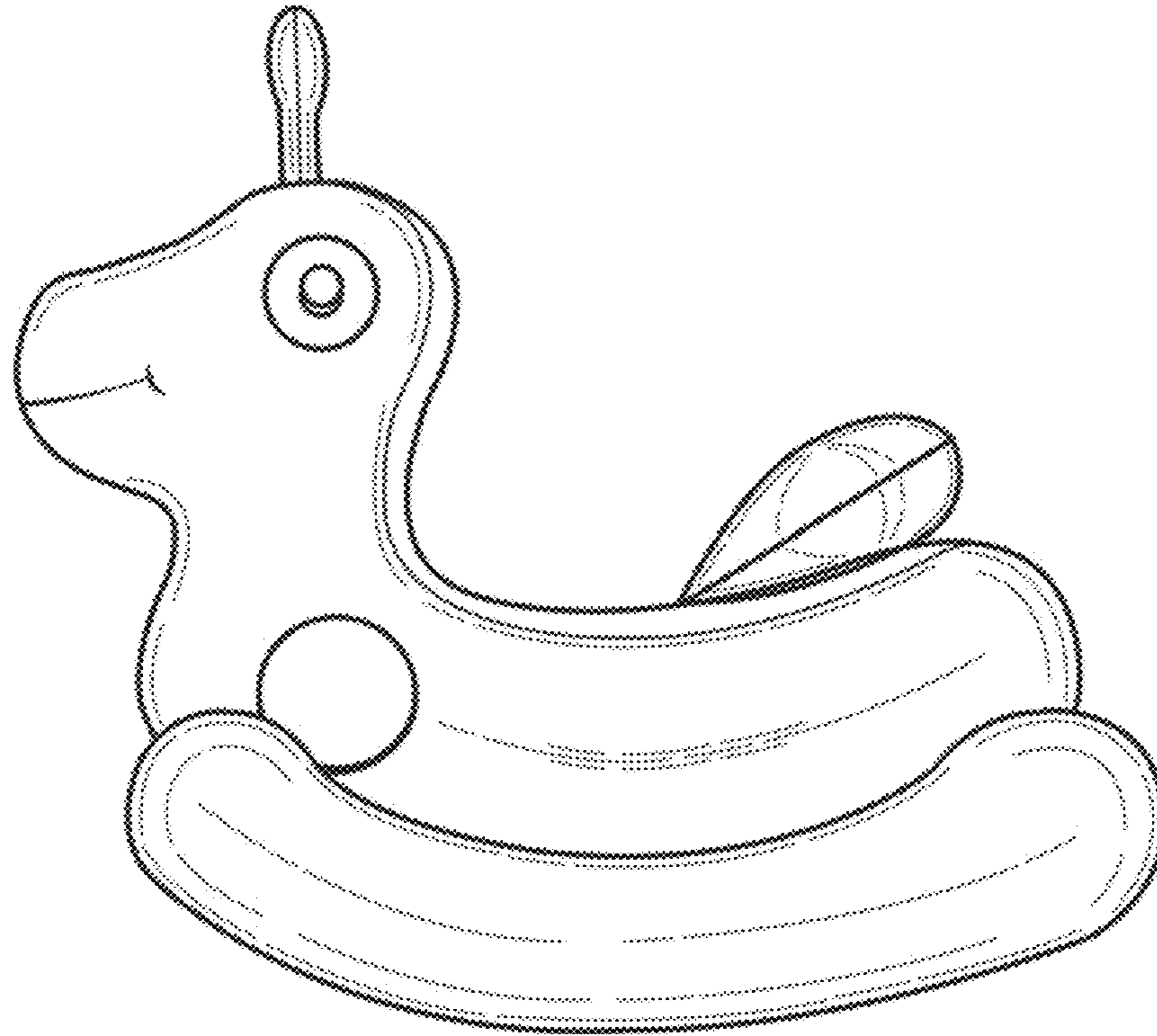

Fig. 2

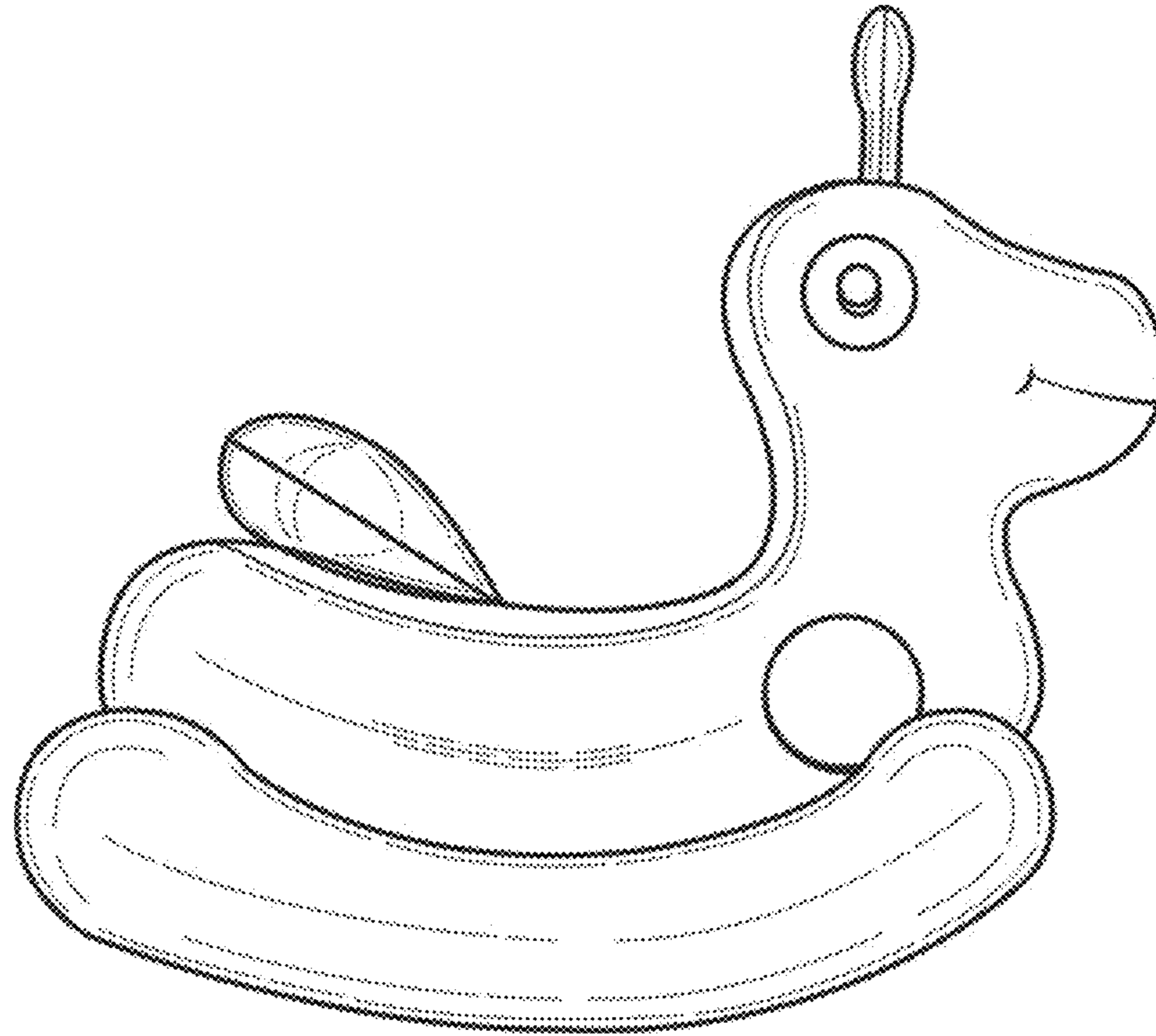

Fig. 3

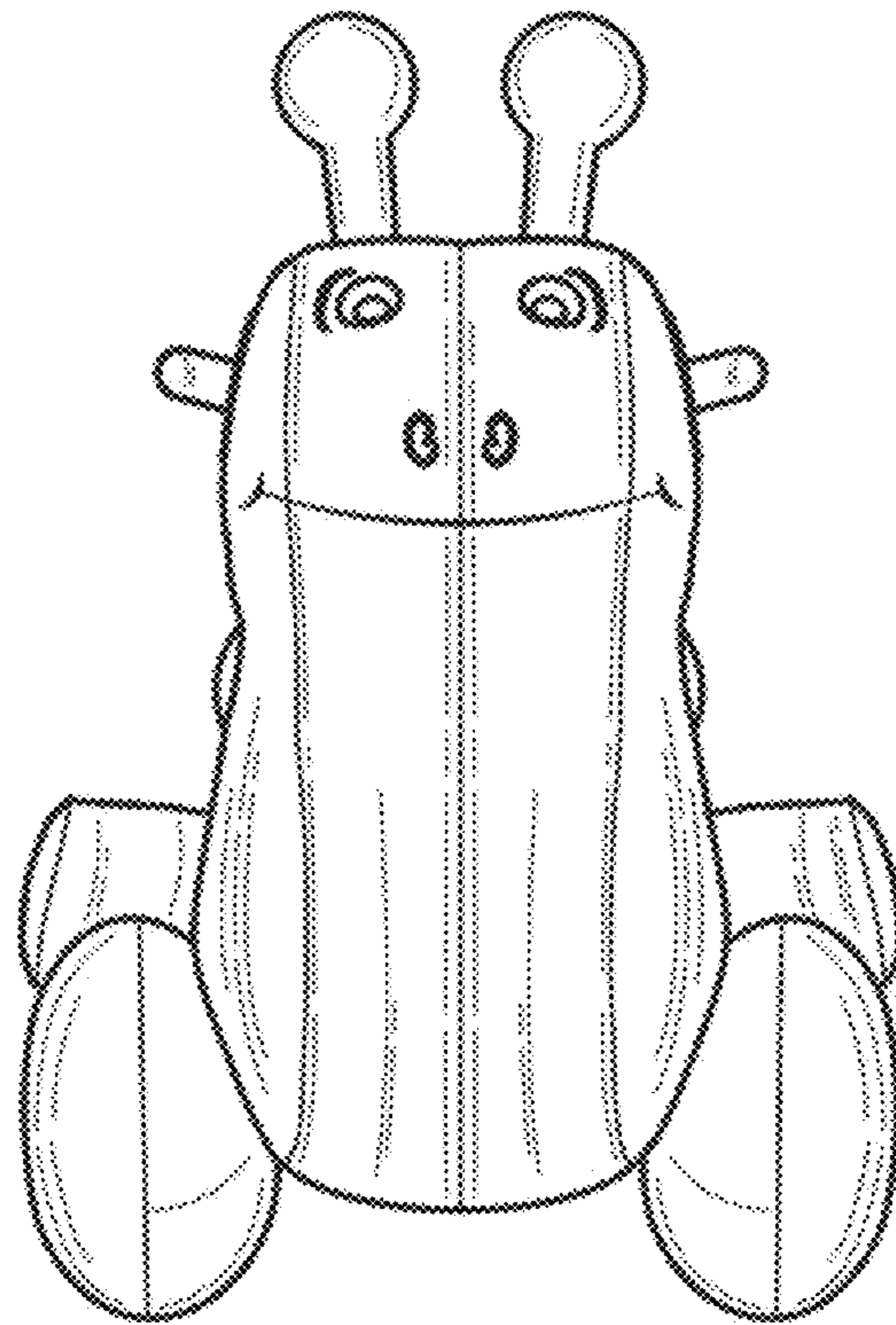

Fig. 4

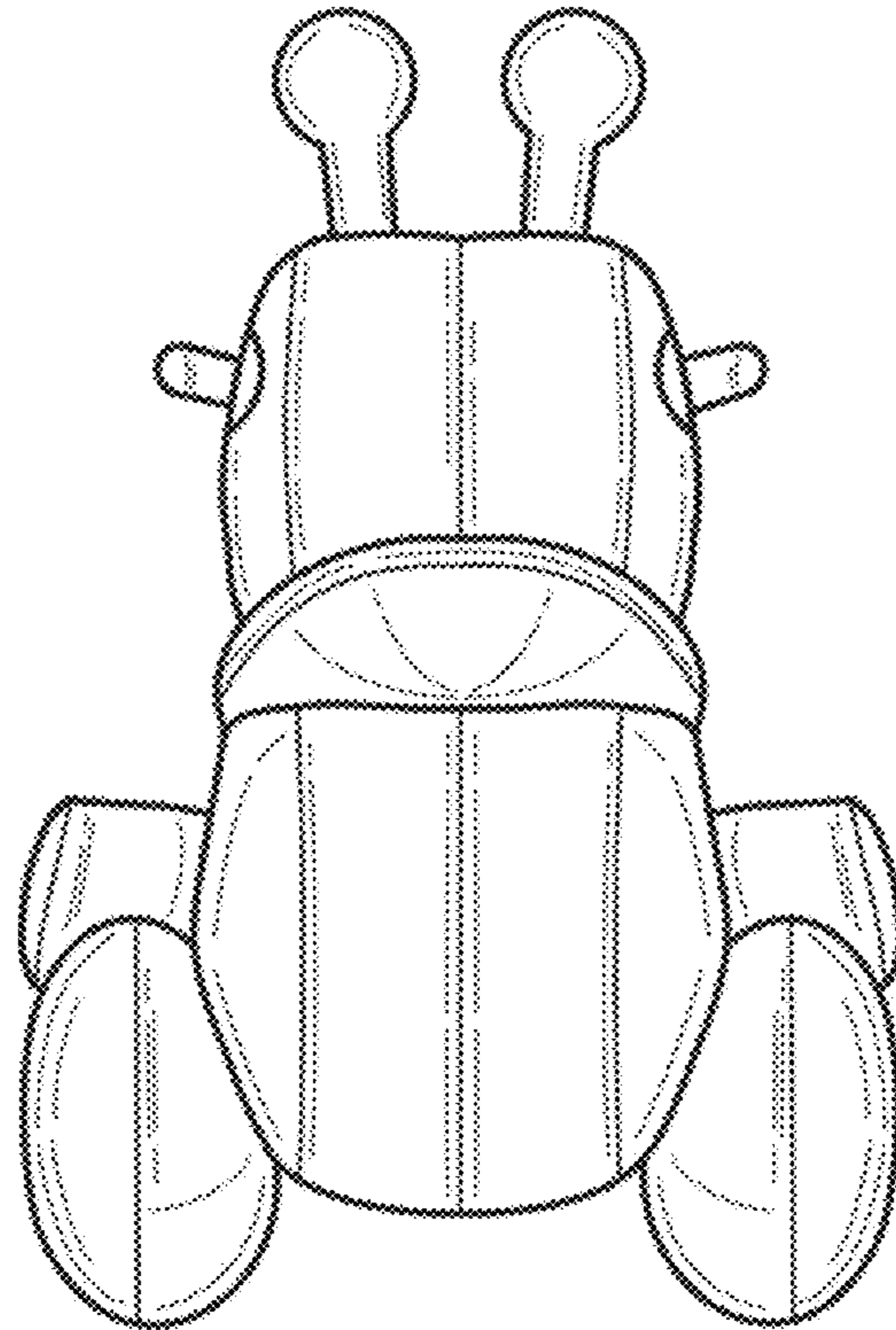

Fig. 5

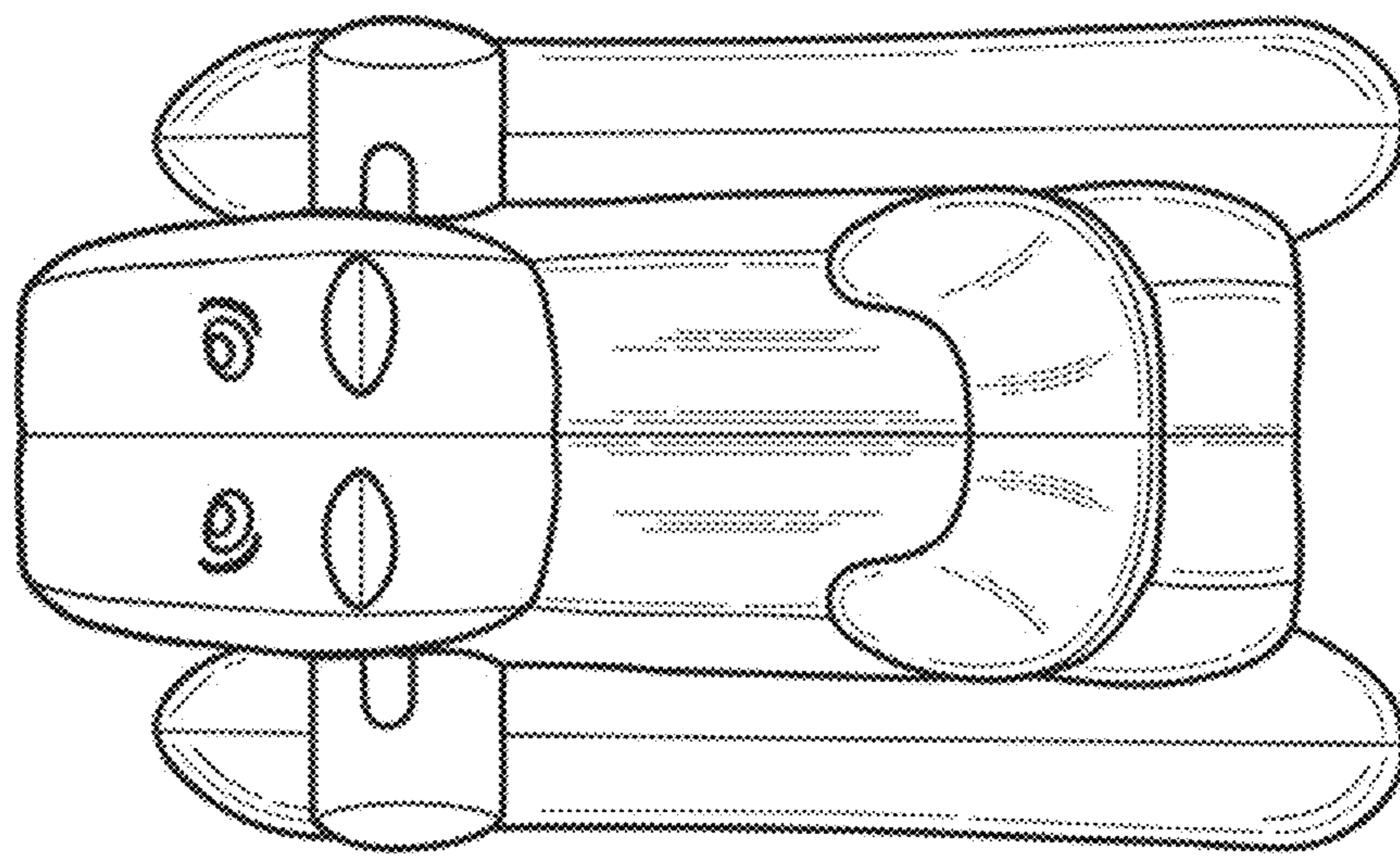

Fig. 6



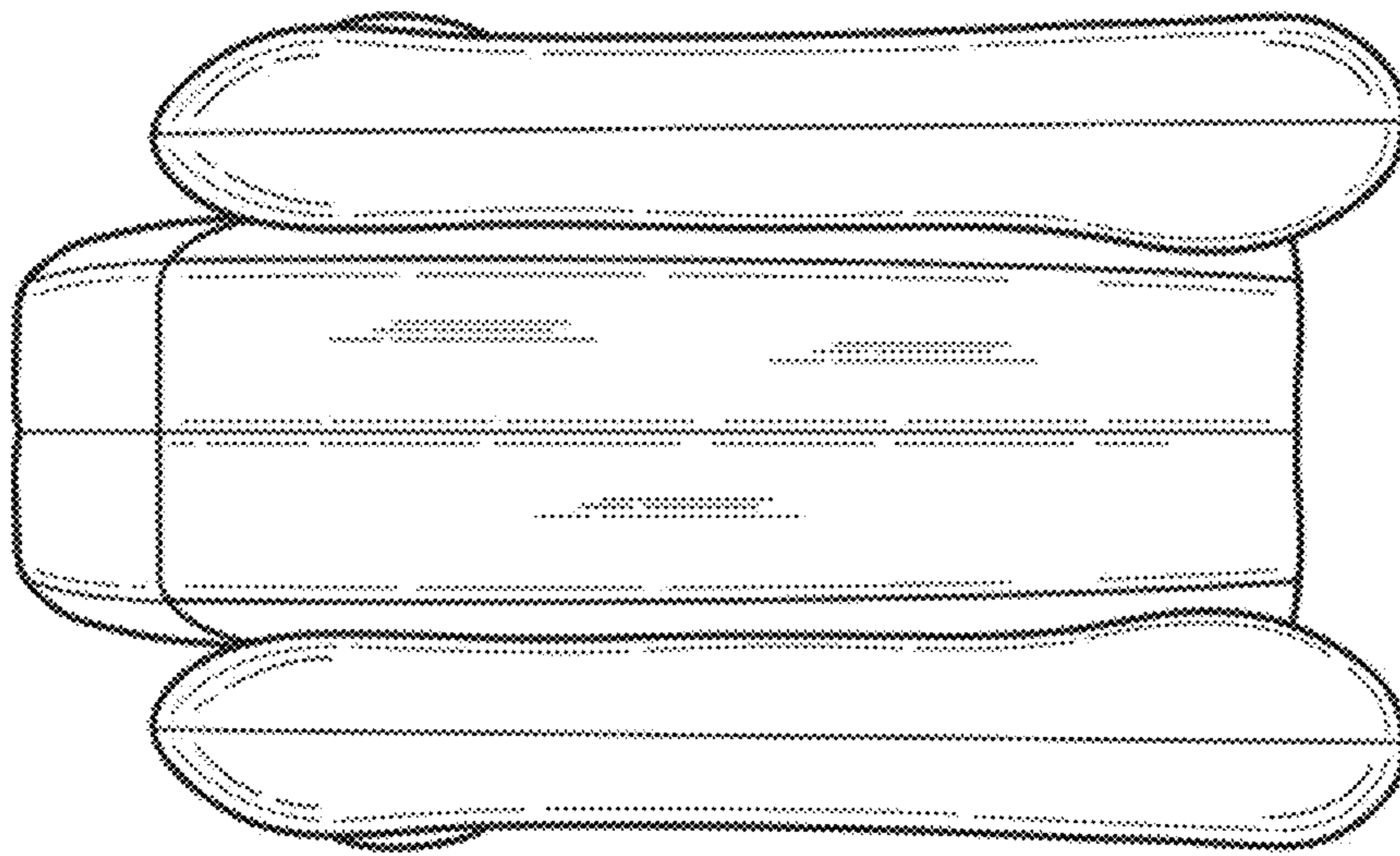

Fig. 7