



US00D798592S

(12) **United States Design Patent**
Steffes

(10) **Patent No.:** **US D798,592 S**

(45) **Date of Patent:** **** Oct. 3, 2017**

(54) **WALLET**

DESCRIPTION

(71) Applicant: **Robert D. Steffes**, Wauwatosa, WI (US)
(72) Inventor: **Robert D. Steffes**, Wauwatosa, WI (US)
(**) Term: **15 Years**
(21) Appl. No.: **29/577,134**
(22) Filed: **Sep. 9, 2016**
(51) **LOC (10) Cl.** **03-01**
(52) **U.S. Cl.**
USPC **D3/247**
(58) **Field of Classification Search**
USPC D3/234, 238, 248
CPC A45C 1/06; A45C 3/08
See application file for complete search history.

(56) **References Cited**

U.S. PATENT DOCUMENTS

D339,915 S	*	10/1993	Lucas	D21/713
D572,474 S	*	7/2008	Tuttle	D3/248
D584,050 S	*	1/2009	Austin	D3/248
D629,605 S	*	12/2010	Traiger	D3/234
D701,042 S	*	3/2014	Austin	D3/247
D725,906 S	*	4/2015	Austin	D3/249

* cited by examiner

Primary Examiner — Holly H Baynham

(74) *Attorney, Agent, or Firm* — Christopher M. Scherer;
DeWitt Ross & Stevens S.C.

(57) **CLAIM**

The ornamental design for a wallet, as shown and described.

FIG. 1 is a perspective view of a first embodiment of a wallet;
FIG. 2 is a front view thereof;
FIG. 3 is a back view thereof;
FIG. 4 is a top view thereof;
FIG. 5 is a bottom view thereof;
FIG. 6 is a right side view thereof;
FIG. 7 is a left side view thereof;
FIG. 8 is a perspective view of a second embodiment of a wallet;
FIG. 9 is a front view thereof;
FIG. 10 is a back view thereof;
FIG. 11 is a top view thereof;
FIG. 12 is a bottom view thereof;
FIG. 13 is a right side view thereof;
FIG. 14 is a left side view thereof;
FIG. 15 is a perspective view of a third embodiment of a wallet;
FIG. 16 is a front view thereof;
FIG. 17 is a back view thereof;
FIG. 18 is a top view thereof;
FIG. 19 is a bottom view thereof;
FIG. 20 is a right side view thereof;
FIG. 21 is a left side view thereof;
FIG. 22 is a perspective view of a fourth embodiment of a wallet;
FIG. 23 is a front view thereof;
FIG. 24 is a back view thereof;
FIG. 25 is a top view thereof;
FIG. 26 is a bottom view thereof;
FIG. 27 is a right side view thereof; and,
FIG. 28 is a left side view thereof.
The broken lines in the drawings represent subject matter that forms no part of the claim.

1 Claim, 20 Drawing Sheets

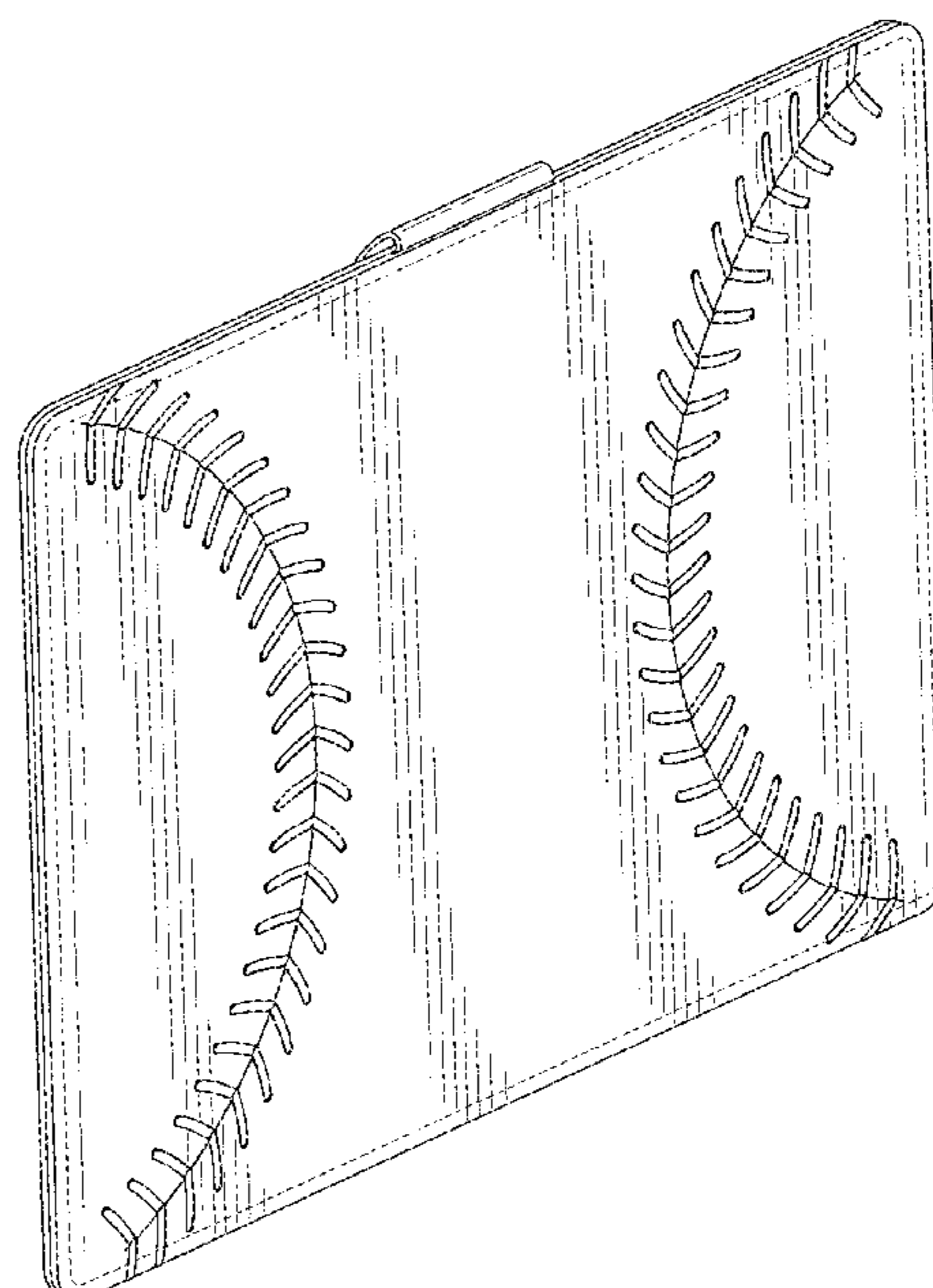
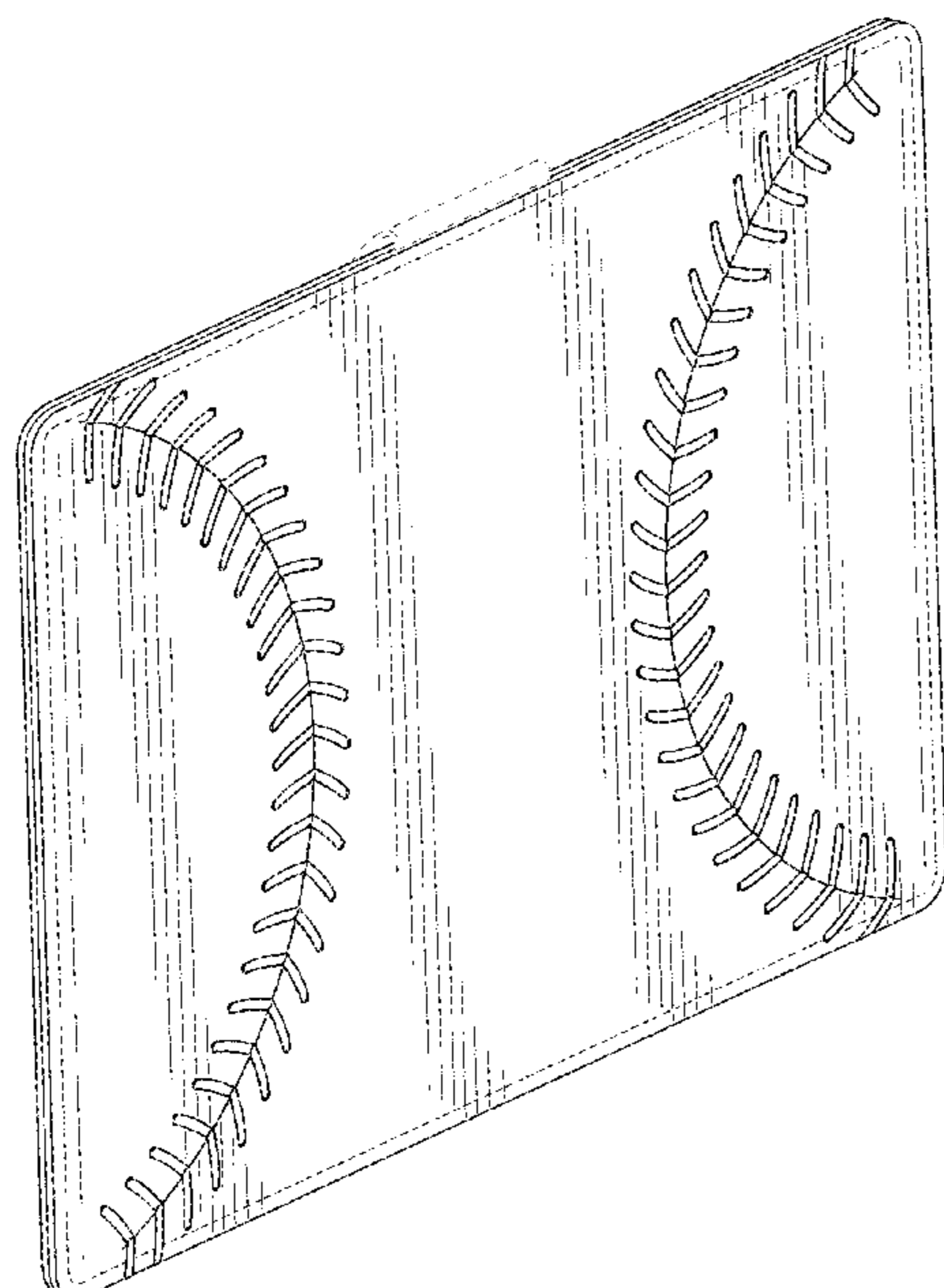

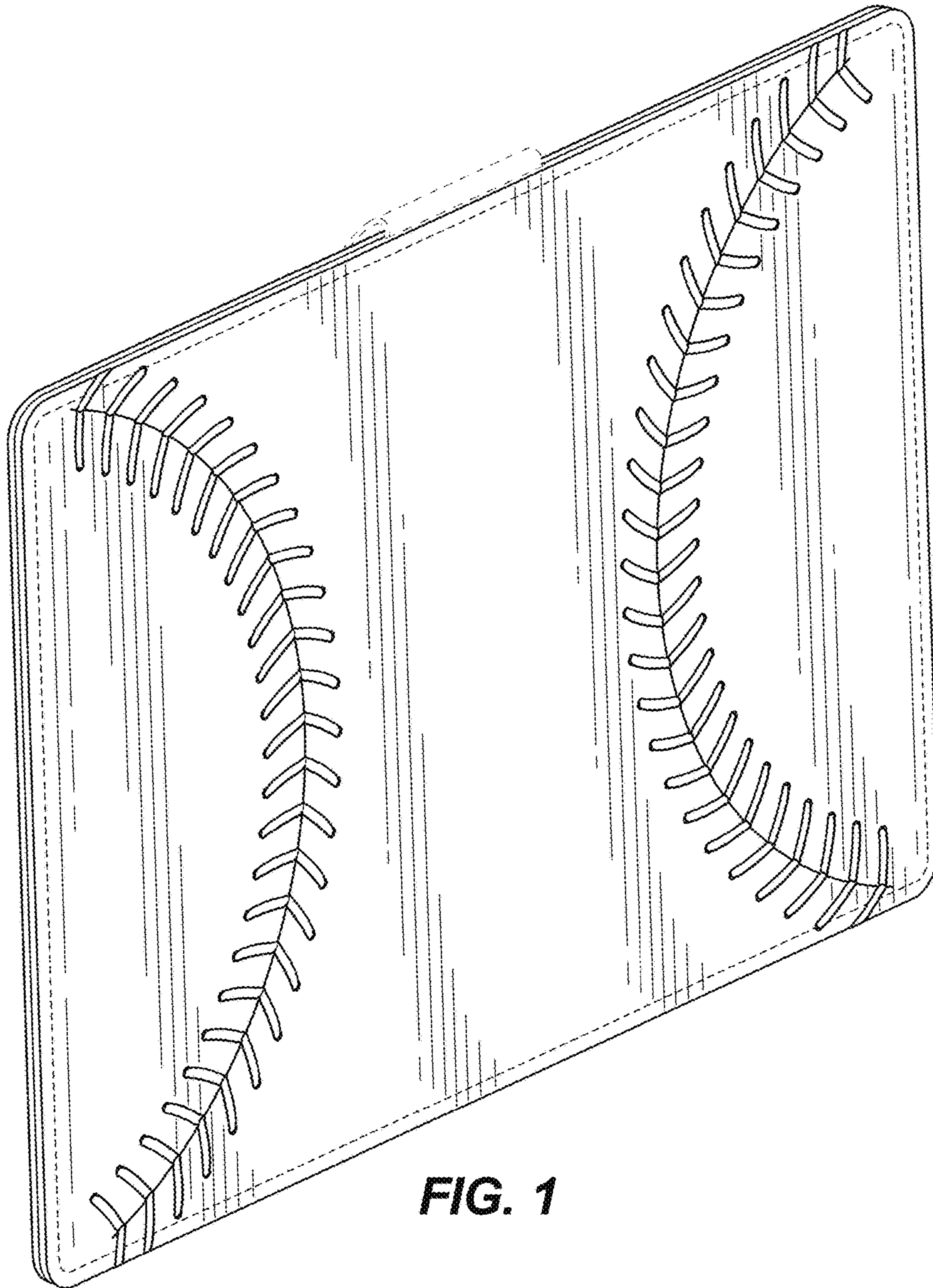

FIG. 1

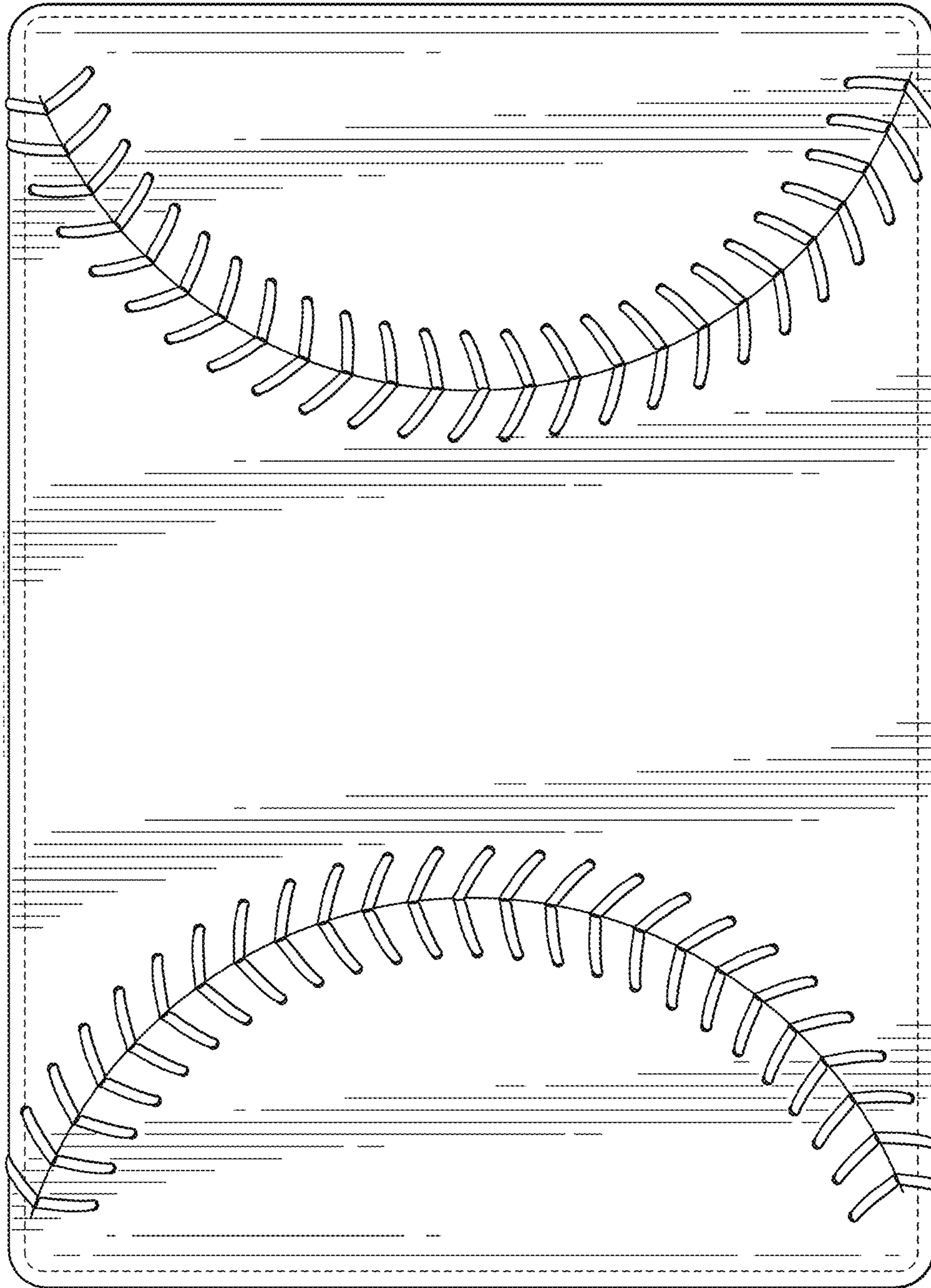

FIG. 2



FIG. 3

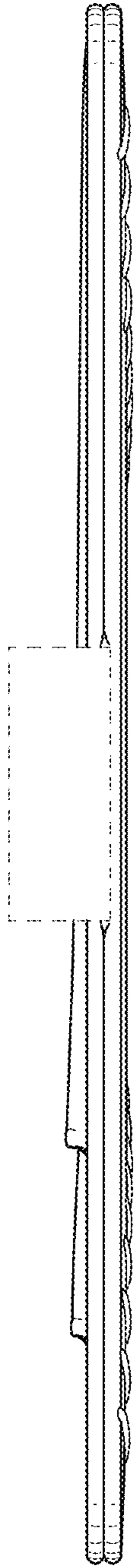

FIG. 4

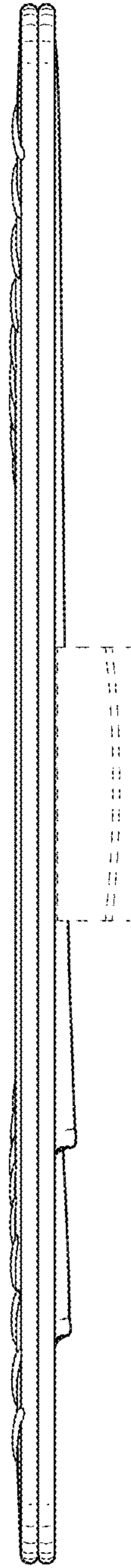

FIG. 5

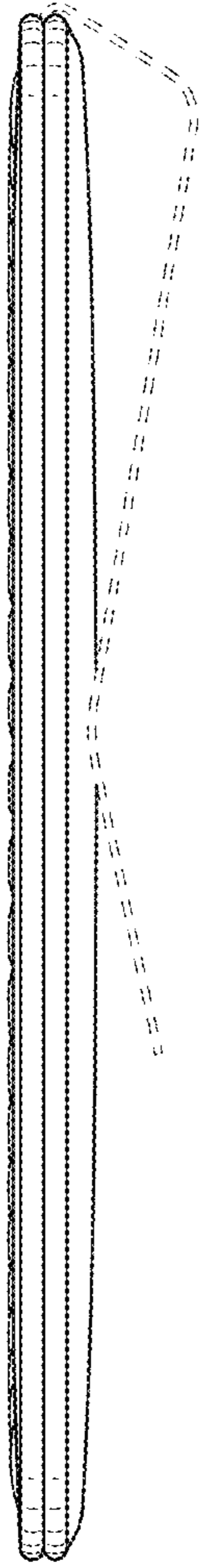

FIG. 6

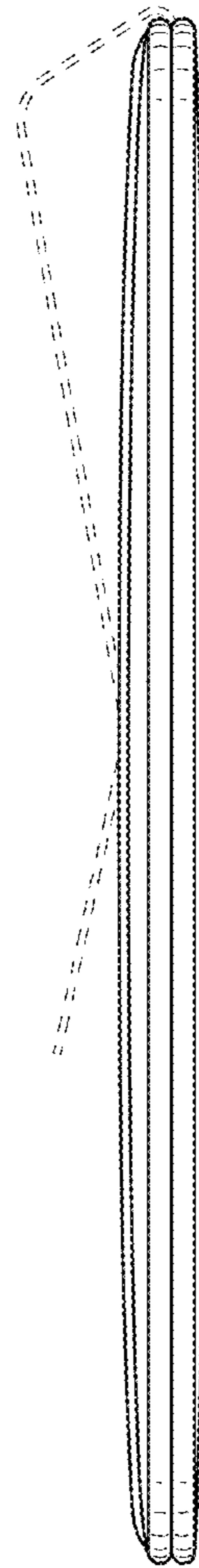

FIG. 7

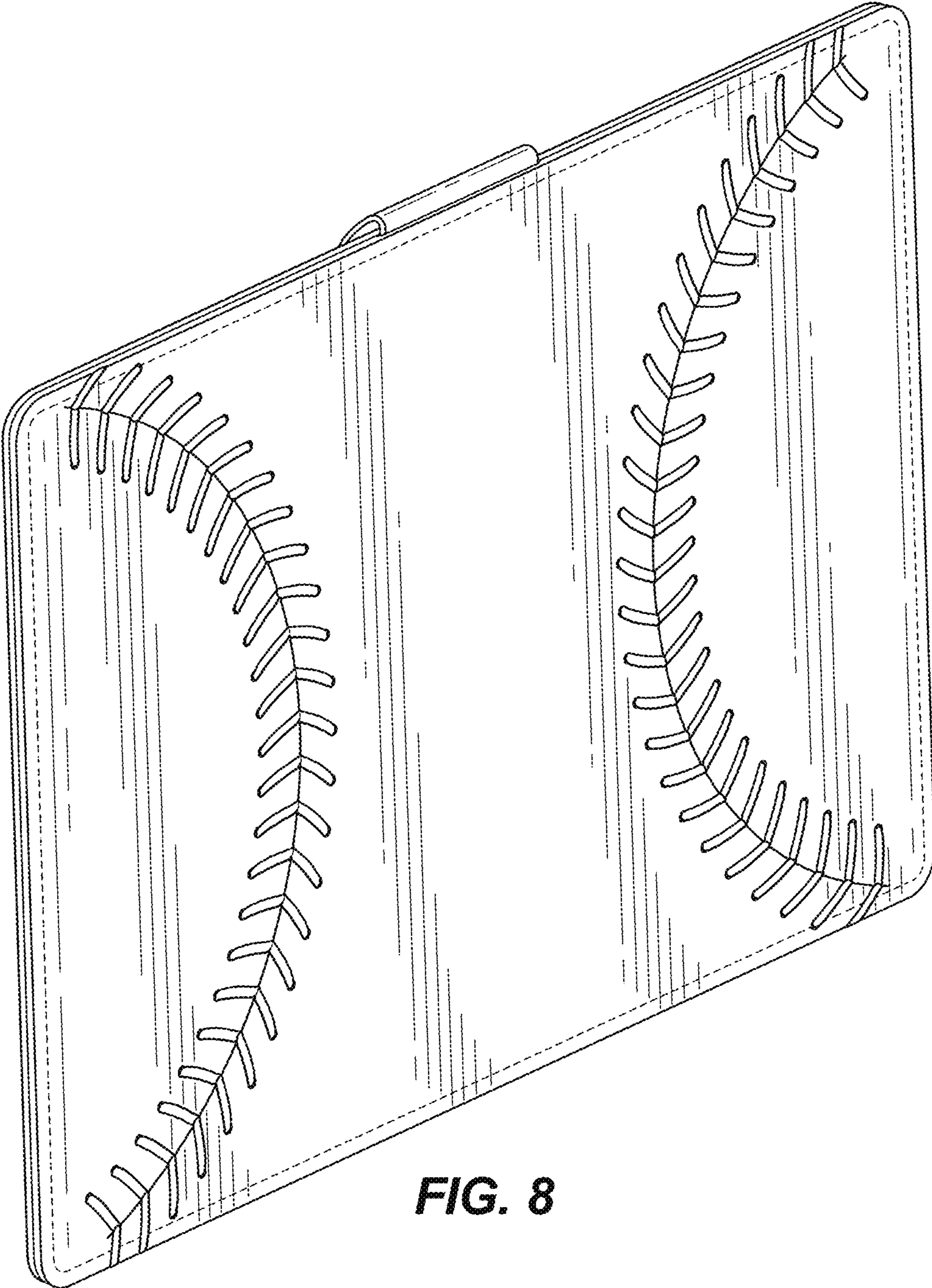

FIG. 8

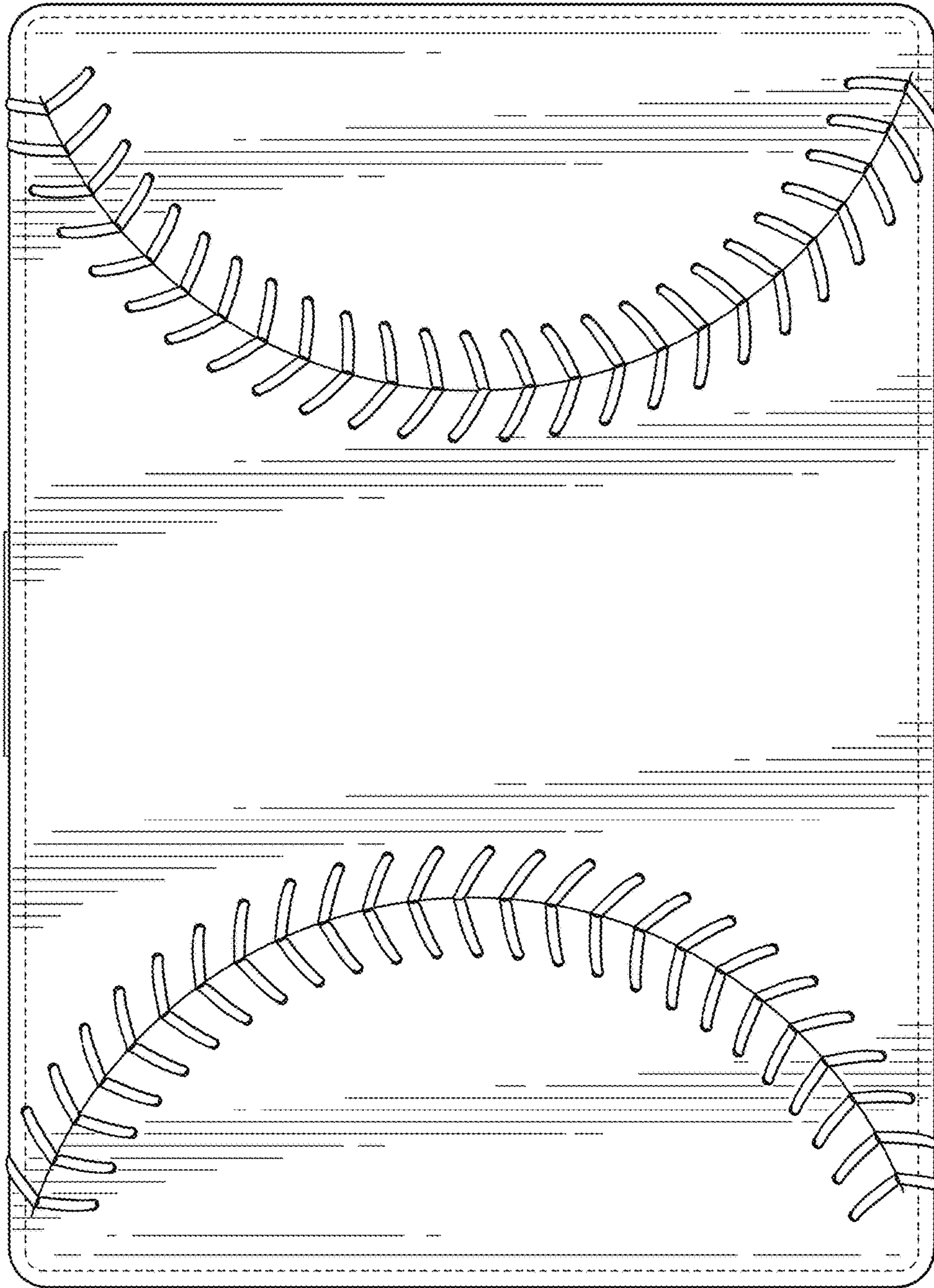

FIG. 9

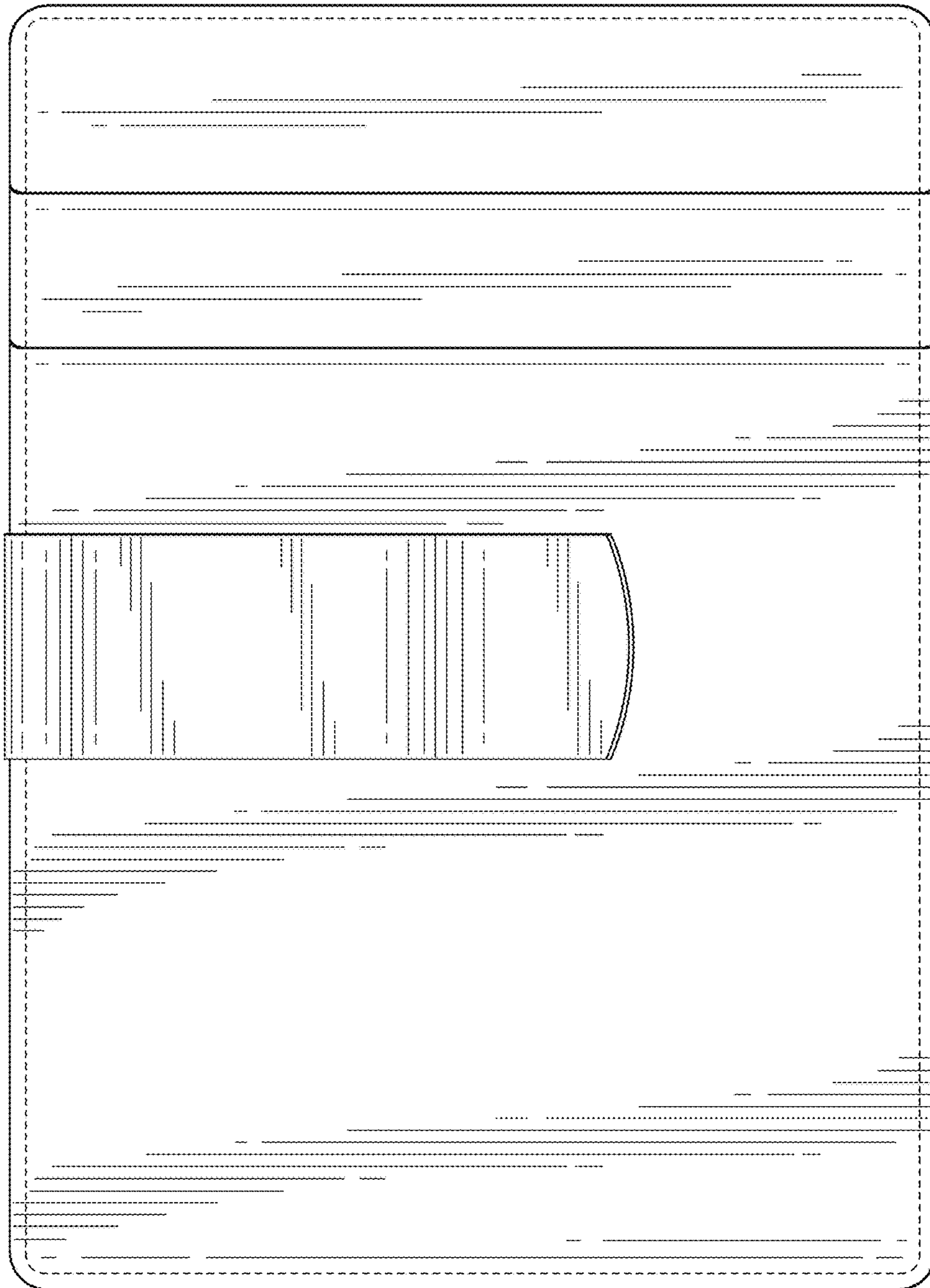

FIG. 10

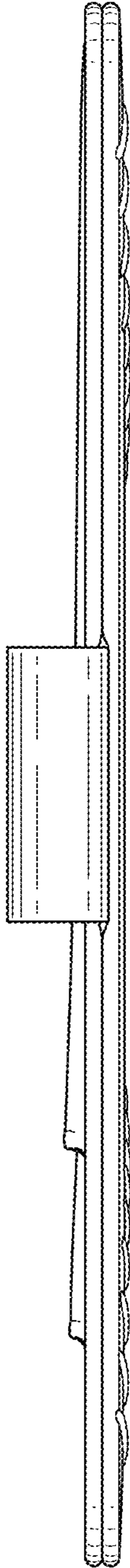

FIG. 11

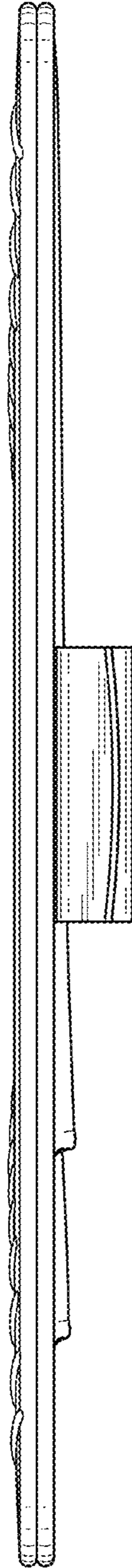

FIG. 12

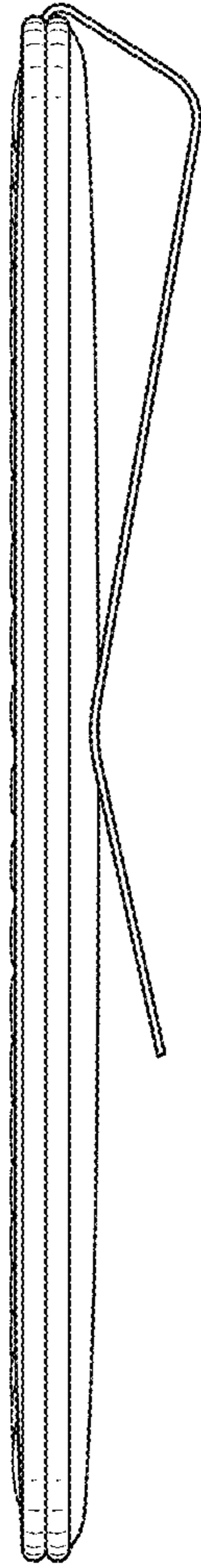

FIG. 13



FIG. 14

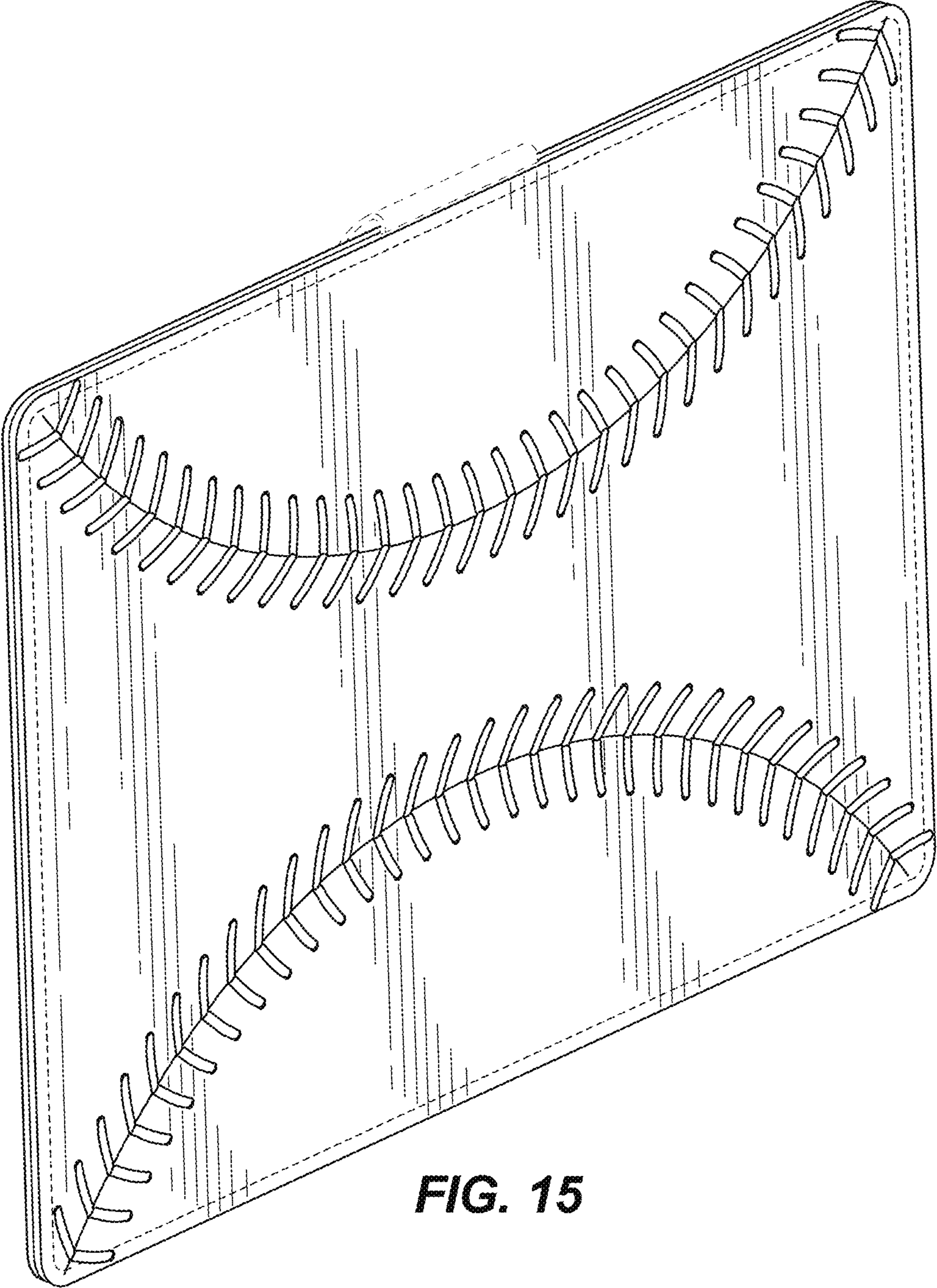

FIG. 15

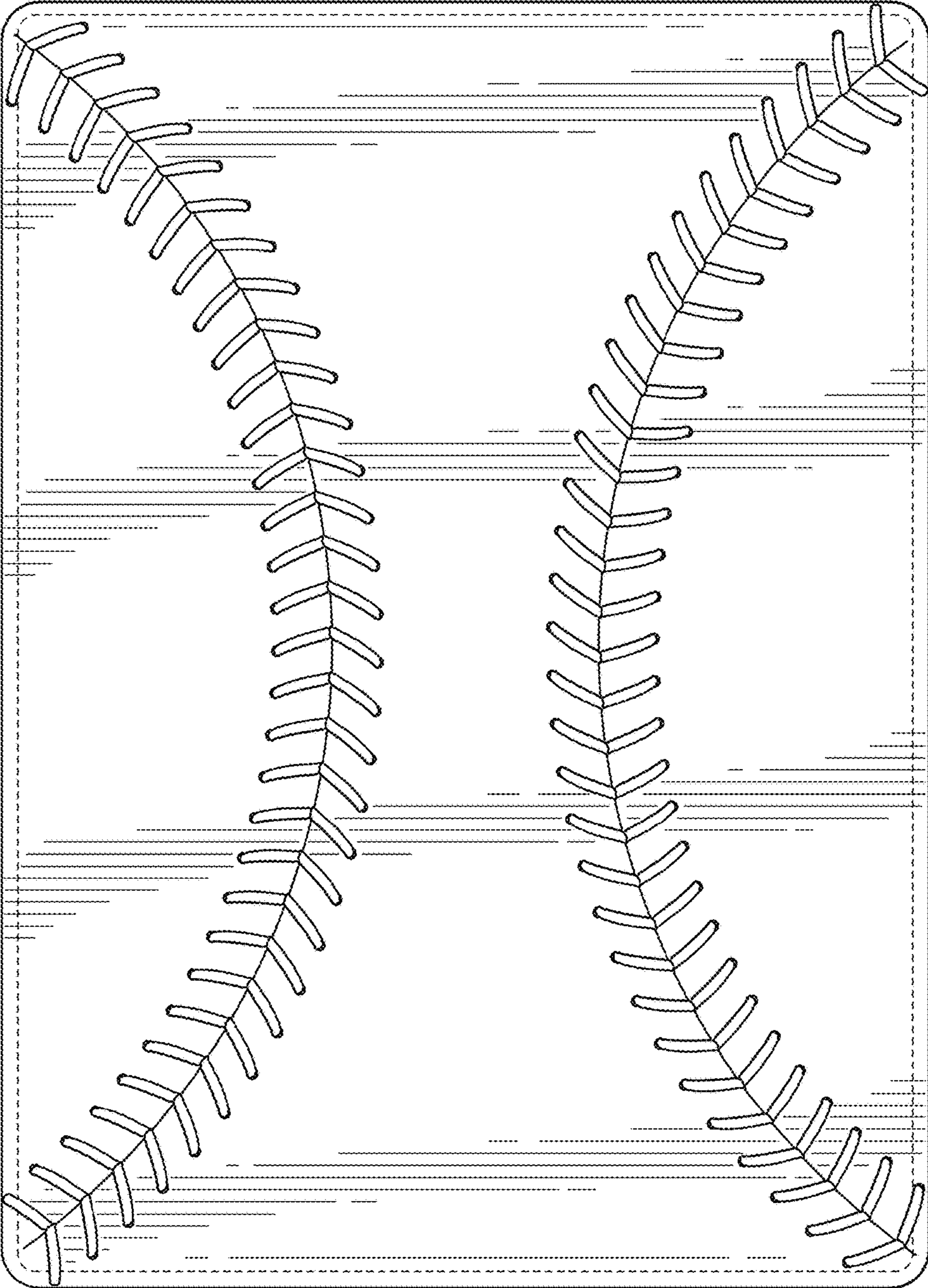

FIG. 16

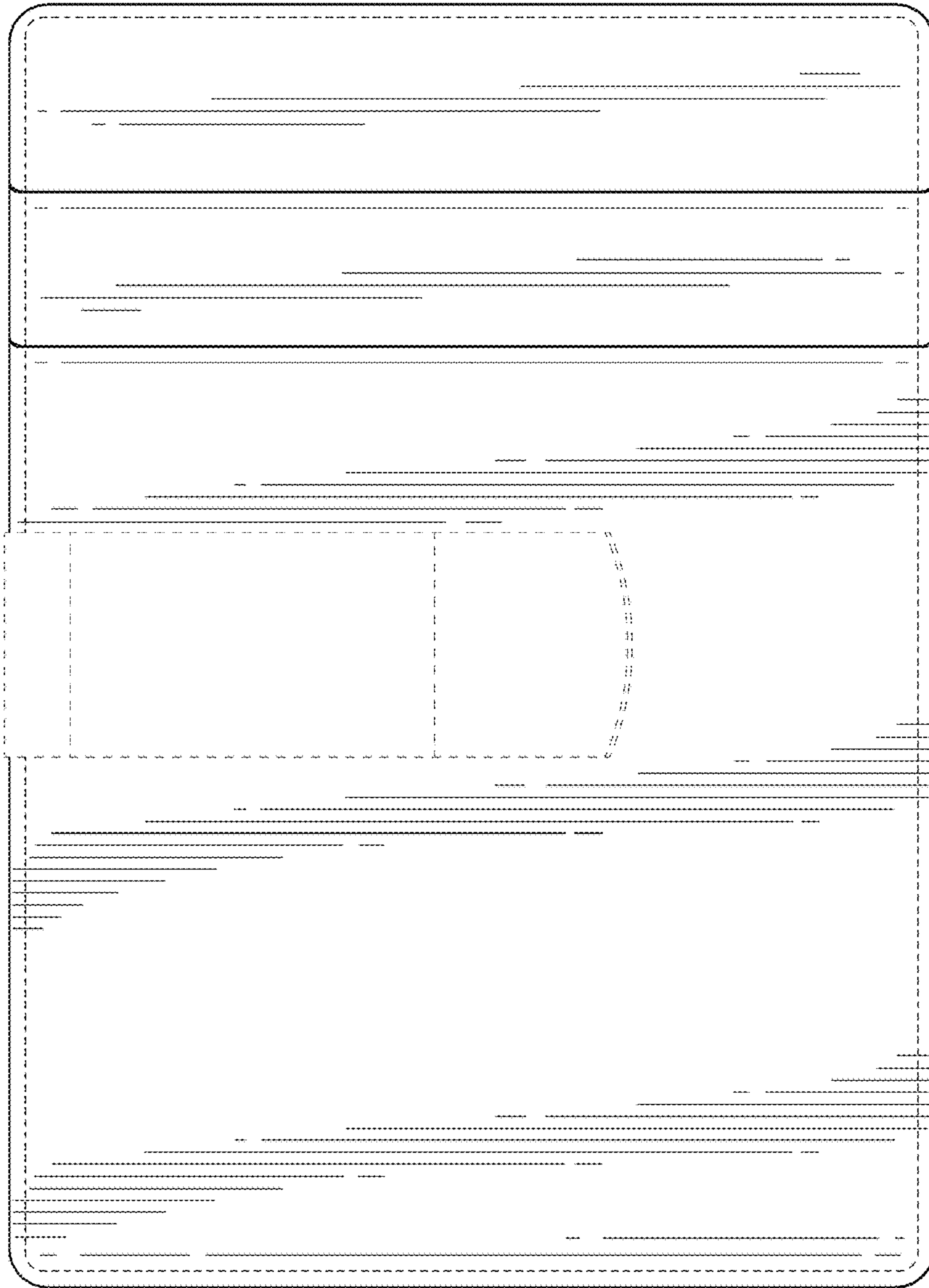

FIG. 17

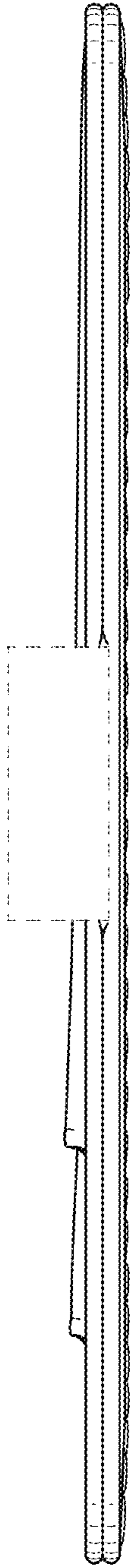

FIG. 18

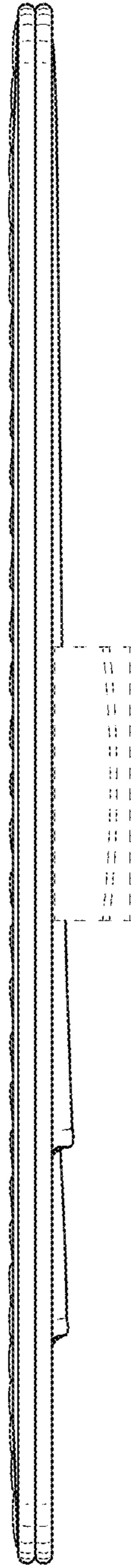

FIG. 19

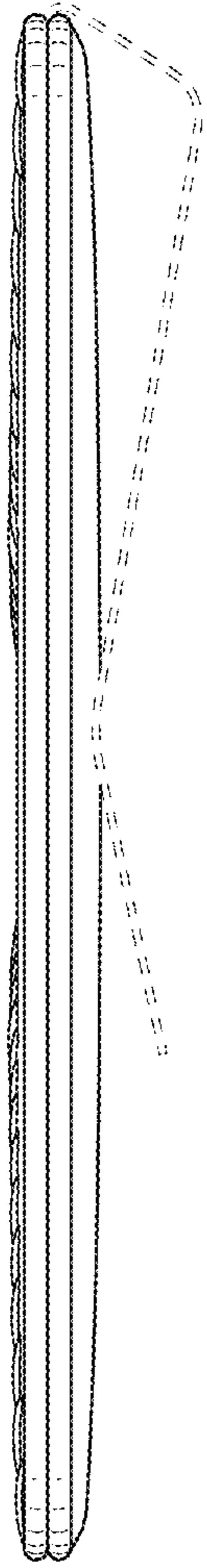

FIG. 20

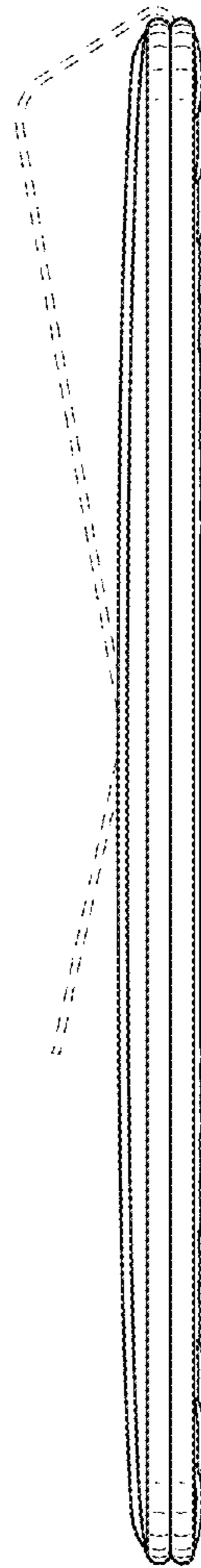

FIG. 21

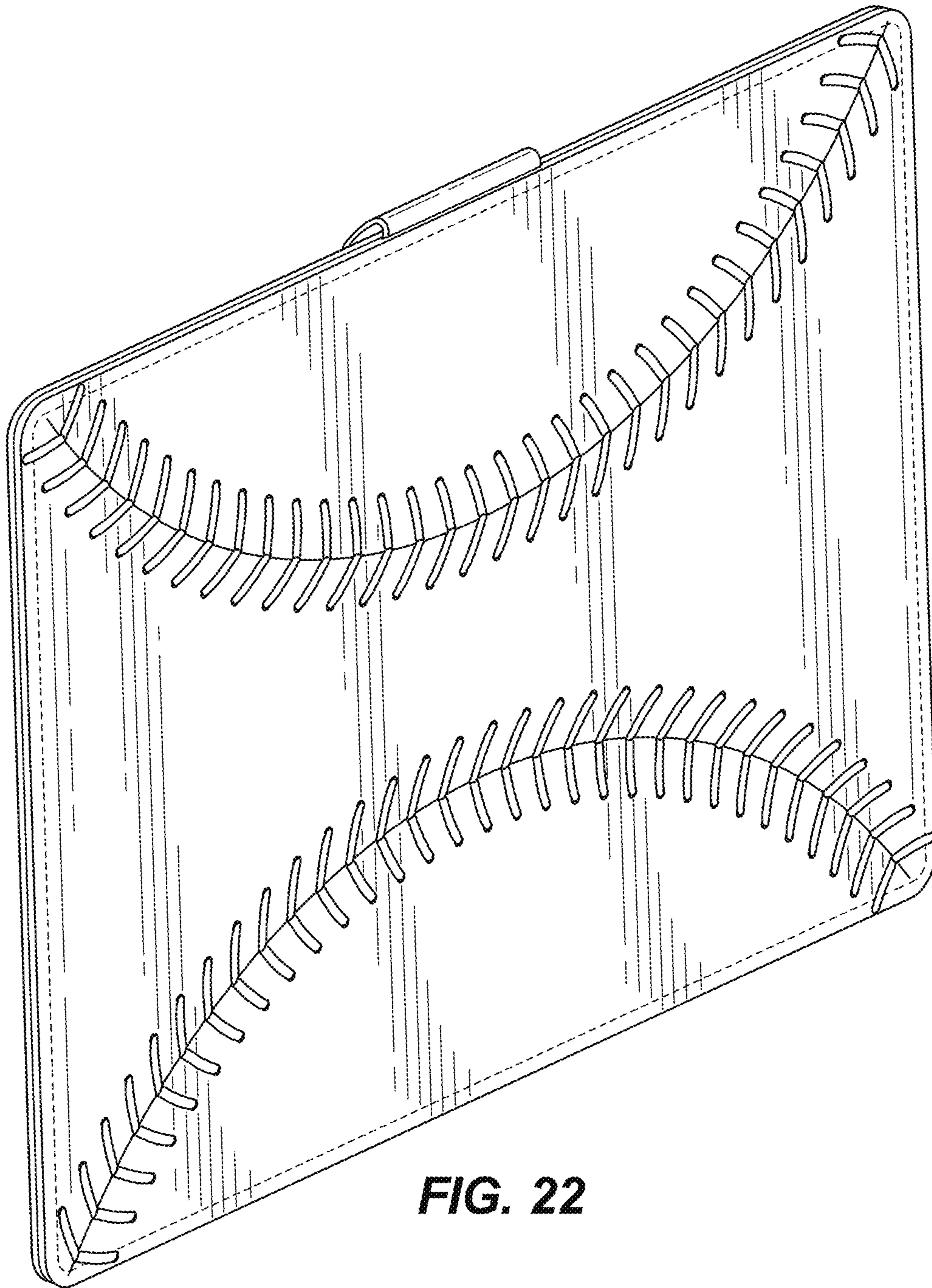

FIG. 22

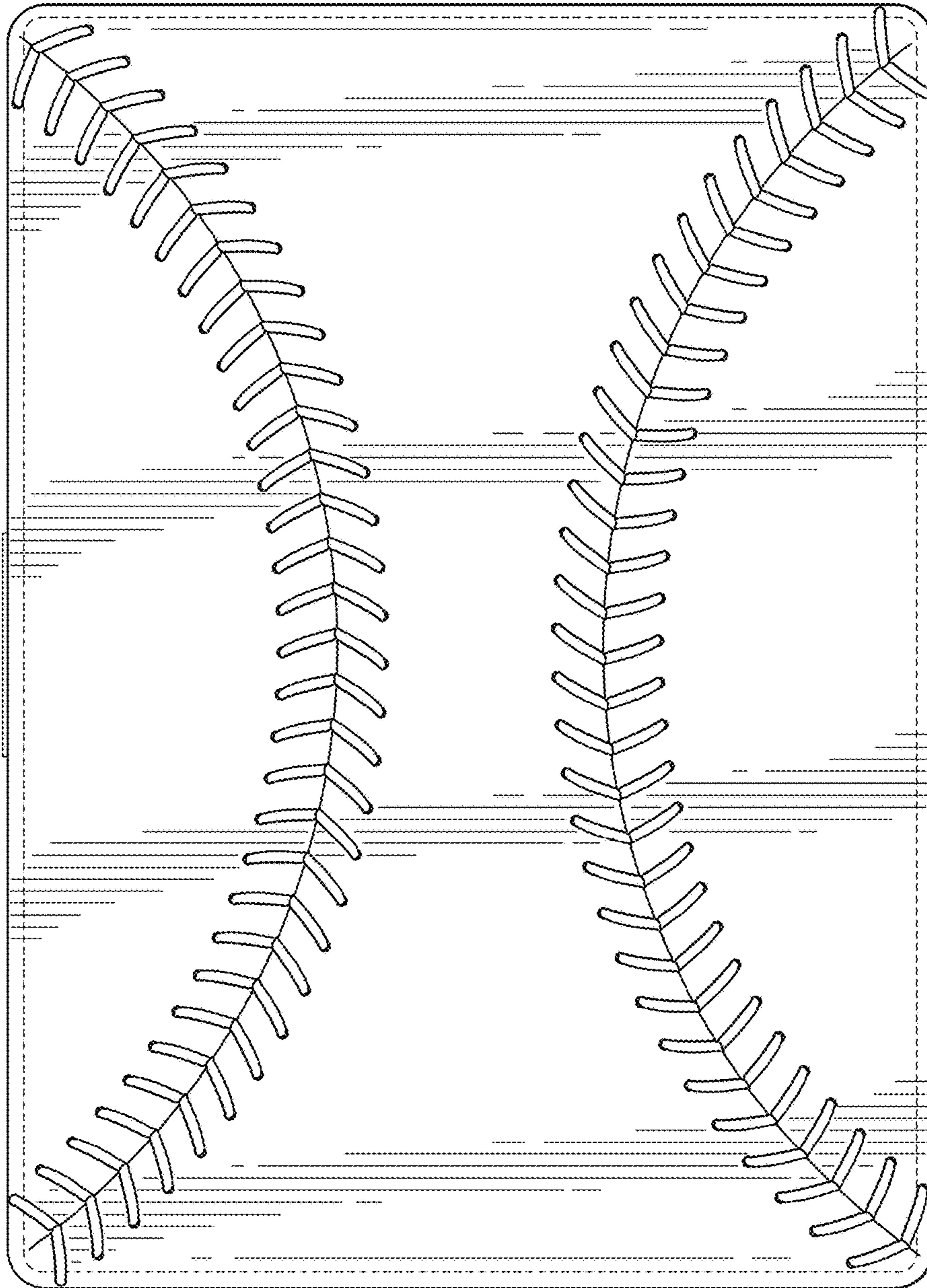

FIG. 23

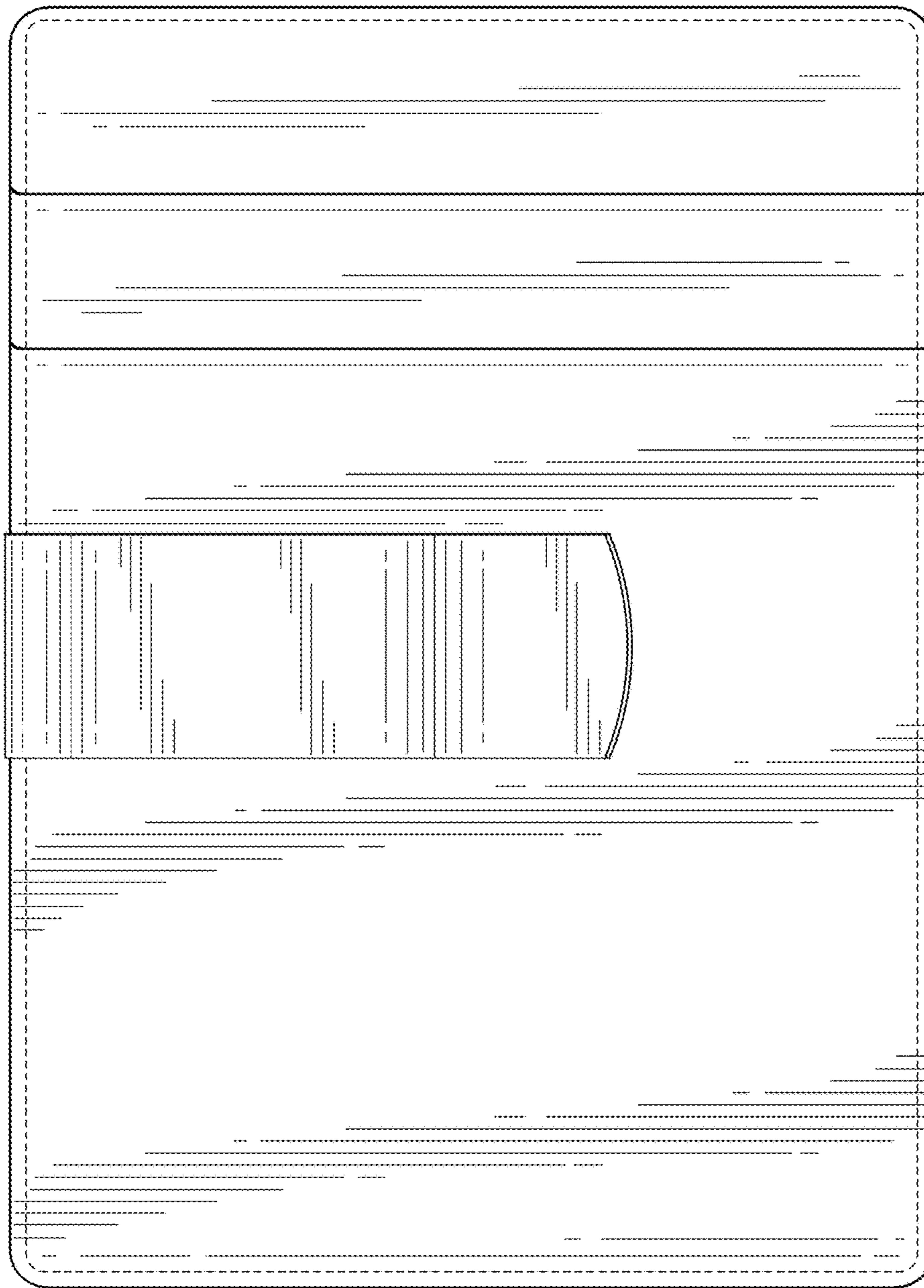

FIG. 24

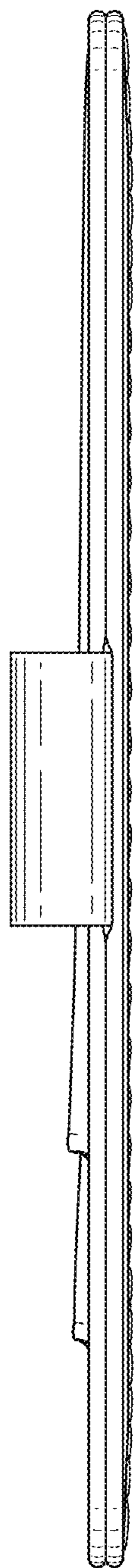

FIG. 25

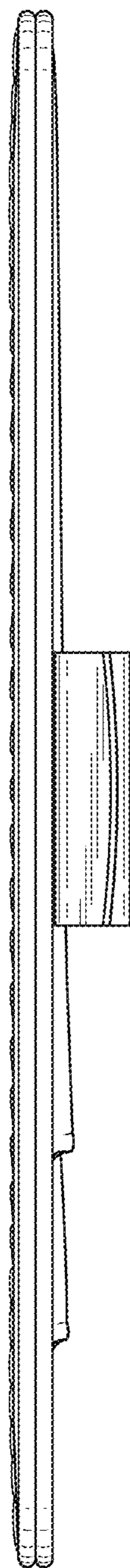

FIG. 26

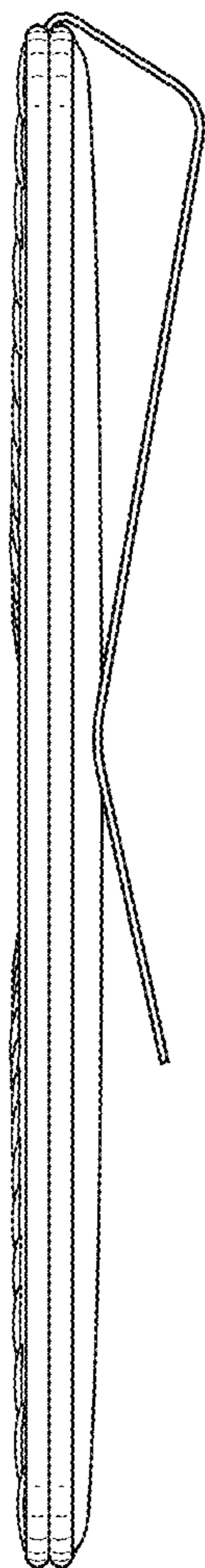

FIG. 27

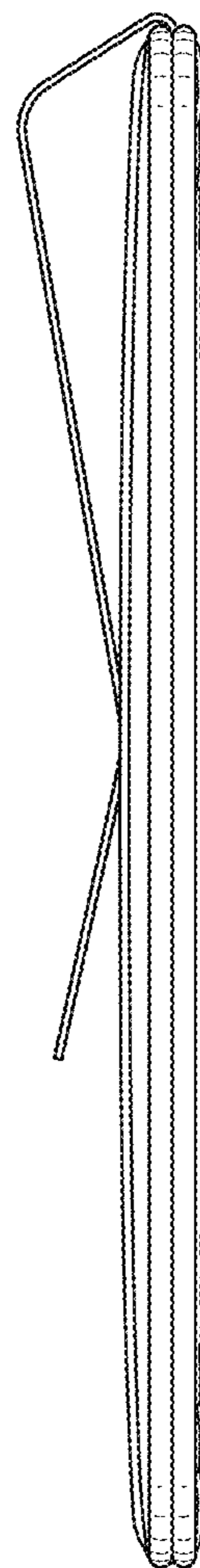

FIG. 28