



US00D798532S

(12) **United States Design Patent**
Dacumos

(10) **Patent No.:** **US D798,532 S**

(45) **Date of Patent:** **** Oct. 3, 2017**

(54) **BRA WITH TWO ROWS OF BACK SNAPS**

(71) Applicant: **Simeon Dacumos**, San Francisco, CA
(US)

(72) Inventor: **Simeon Dacumos**, San Francisco, CA
(US)

(**) Term: **15 Years**

(21) Appl. No.: **29/565,469**

(22) Filed: **May 20, 2016**

(51) **LOC (10) Cl.** **02-01**

(52) **U.S. Cl.**
USPC **D2/706**

(58) **Field of Classification Search**
USPC D2/706-709, 701-703, 723; 450/53-59
CPC A41F 1/006; A41F 15/002; A41C 1/00;
A41D 13/05; A41D 13/0518
See application file for complete search history.

(56) **References Cited**

U.S. PATENT DOCUMENTS

D140,484 S *	2/1945	Paul	D2/708
D277,329 S *	1/1985	Taniyama	D2/708
D452,601 S *	1/2002	Allen	D2/706
D560,877 S *	2/2008	Utaka	D2/706
D587,878 S *	3/2009	Higo	D2/706
D597,279 S *	8/2009	Spillman	D2/706
D599,081 S *	9/2009	Heer	D2/706
D626,308 S *	11/2010	DiGeronimo	D2/706
D630,817 S *	1/2011	McKee	D2/706
D671,298 S *	11/2012	Dandapure	D2/708
D697,695 S *	1/2014	Lopez	D2/708
D709,670 S *	7/2014	Vericella	D2/708
D731,745 S *	6/2015	Maragni	D2/708
D741,566 S *	10/2015	Perry	D2/706

D745,247 S *	12/2015	Mazard	D2/708
D762,044 S *	7/2016	Adachi	D2/706
2016/0360800 A1*	12/2016	Yuasa	A41C 3/144
2017/0035130 A1*	2/2017	Hazzard	A41F 15/002

* cited by examiner

Primary Examiner — Robin V Webster

Assistant Examiner — James Thorn, Sr.

(74) *Attorney, Agent, or Firm* — Steven A. Nielsen;

www.NielsenPatents.com

(57) **CLAIM**

The ornamental design for a bra with two rows of back snaps, as shown and described.

DESCRIPTION

FIG. 1 is a front view of a bra with two rows of back snaps showing a new design;
 FIG. 2 is a back view thereof;
 FIG. 3 is a front perspective view thereof;
 FIG. 4 is a front right perspective view thereof;
 FIG. 5 is a right side view with the left side being a mirror image thereof;
 FIG. 6 is a back right view thereof;
 FIG. 7 is a back view thereof;
 FIG. 8 is an enlarged view of back snaps shown separately for ease of illustration;
 FIG. 9 is a left front perspective view thereof;
 FIG. 10 is a top view thereof; and,
 FIG. 11 is a bottom view thereof.

The broken lines shown in the drawings represent stitching in the fabric and form no part of the claimed design.

The broken lines of the mannequin shown in FIGS. 3-7 and 9 are included for the purpose of illustrating environmental structure and form no part of the claimed design.

1 Claim, 7 Drawing Sheets

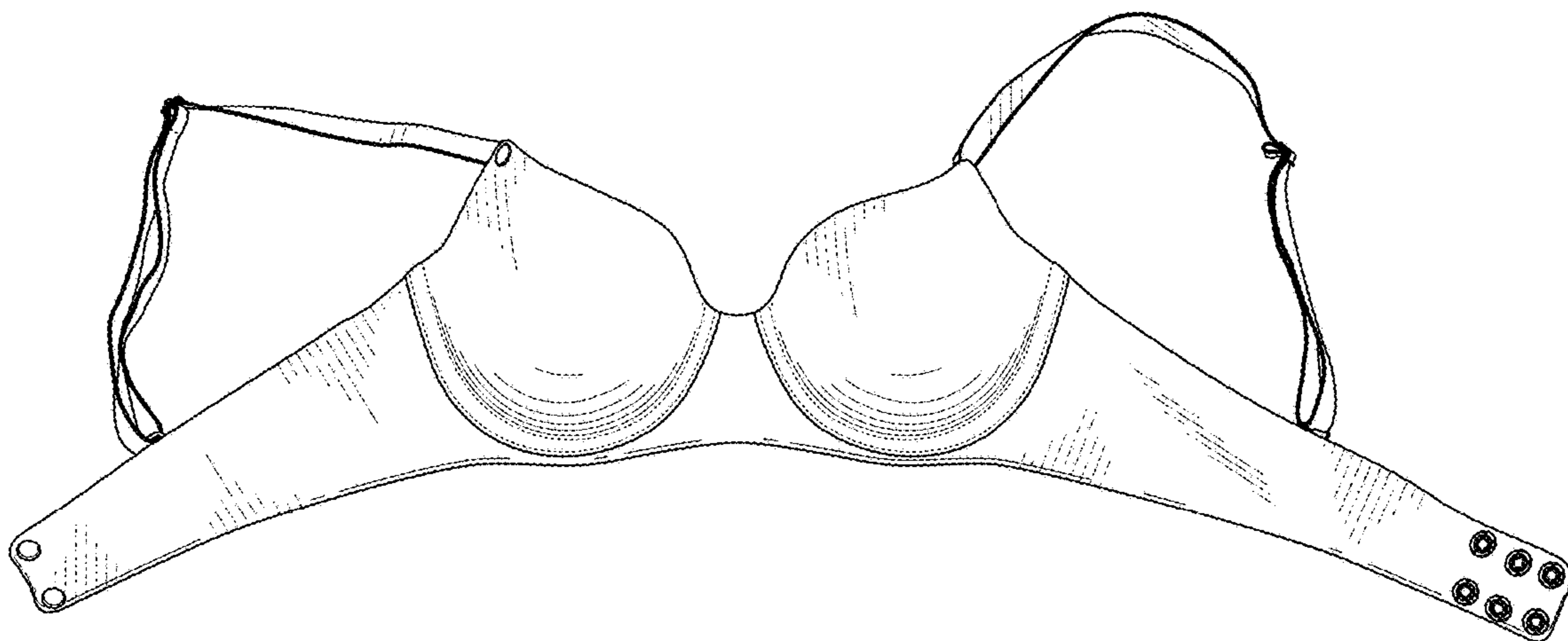

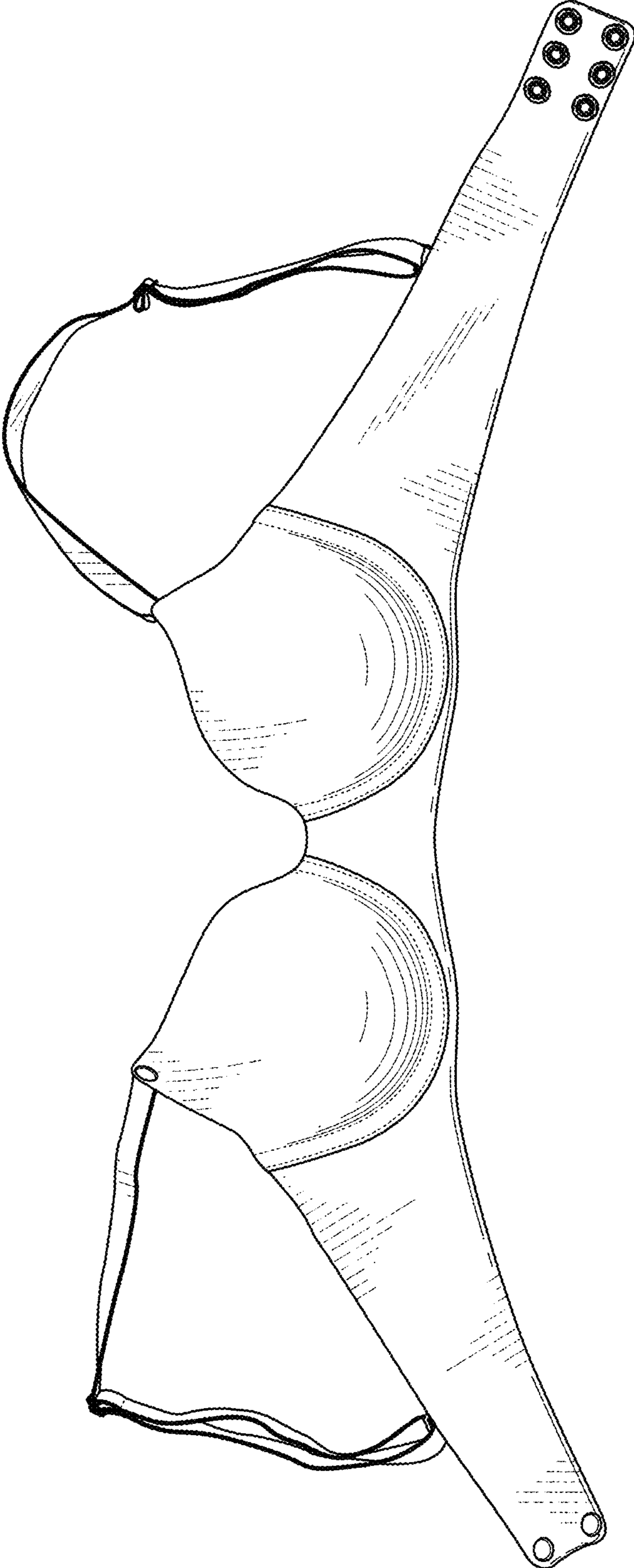

FIG. 1

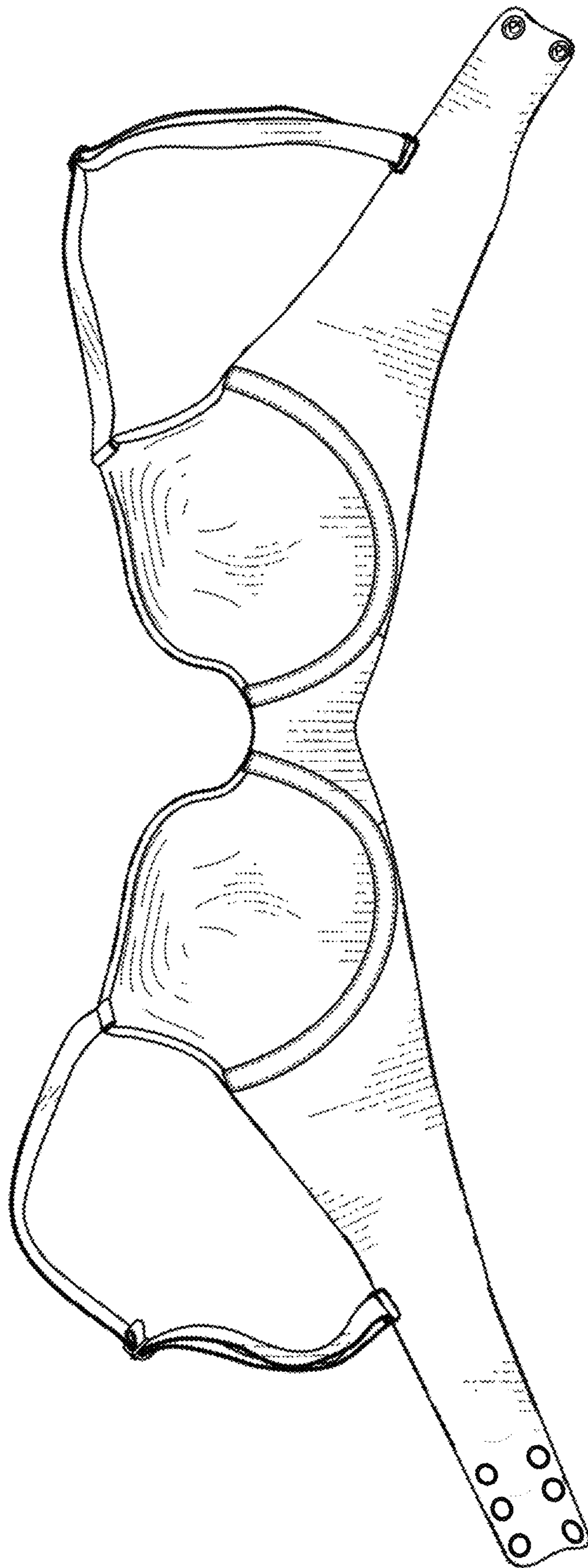

FIG. 2

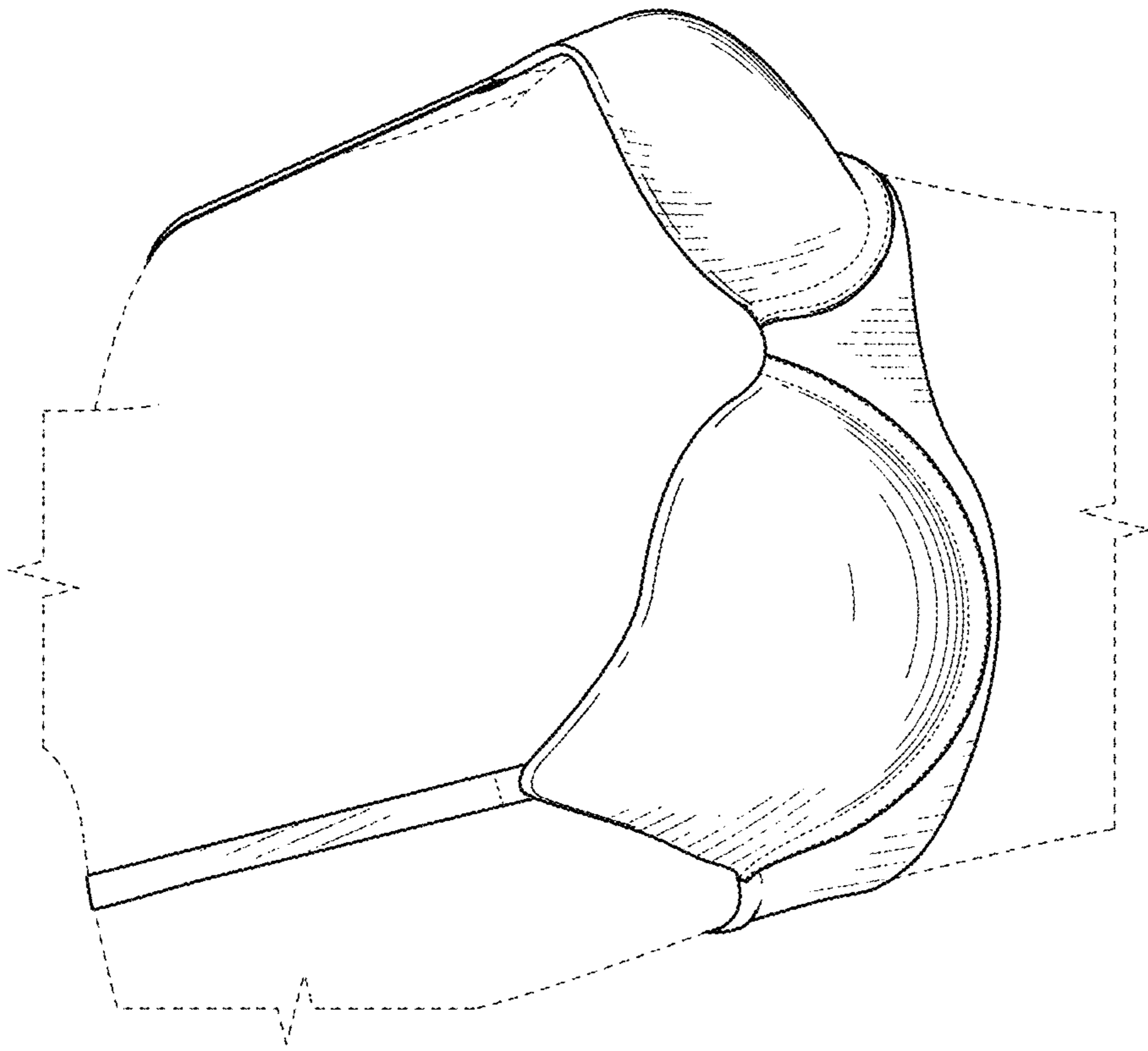

FIG. 4

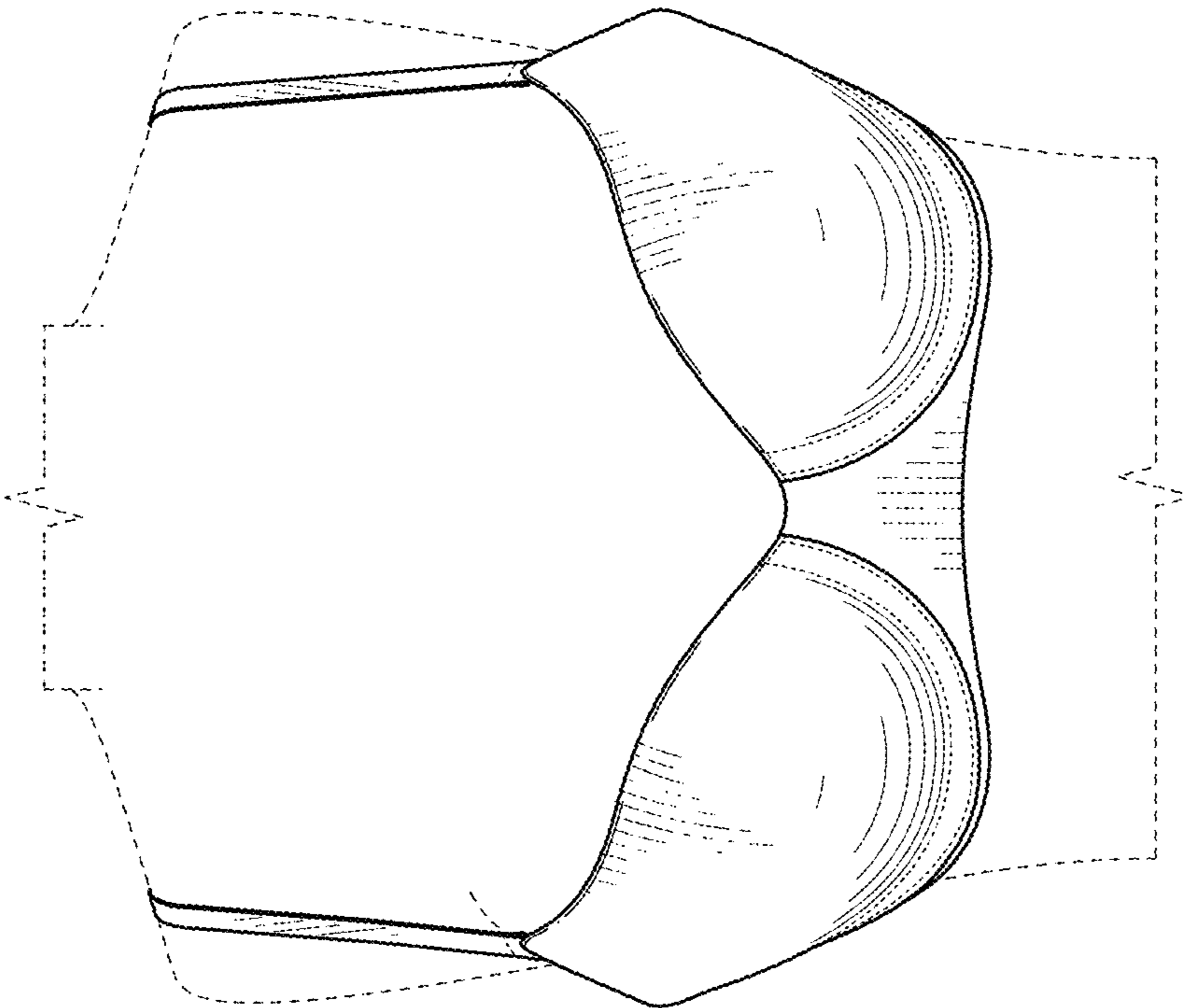

FIG. 3

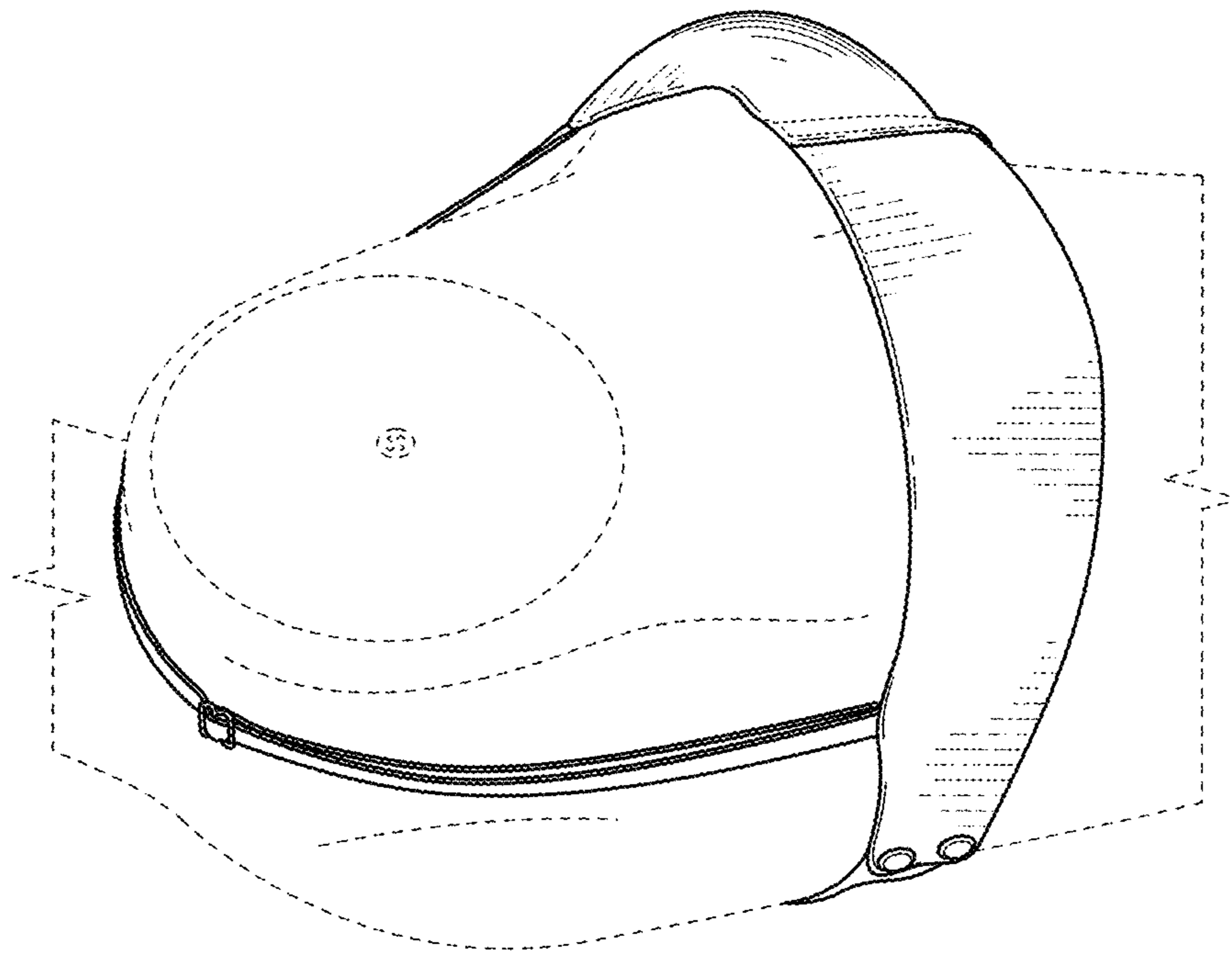

FIG. 6

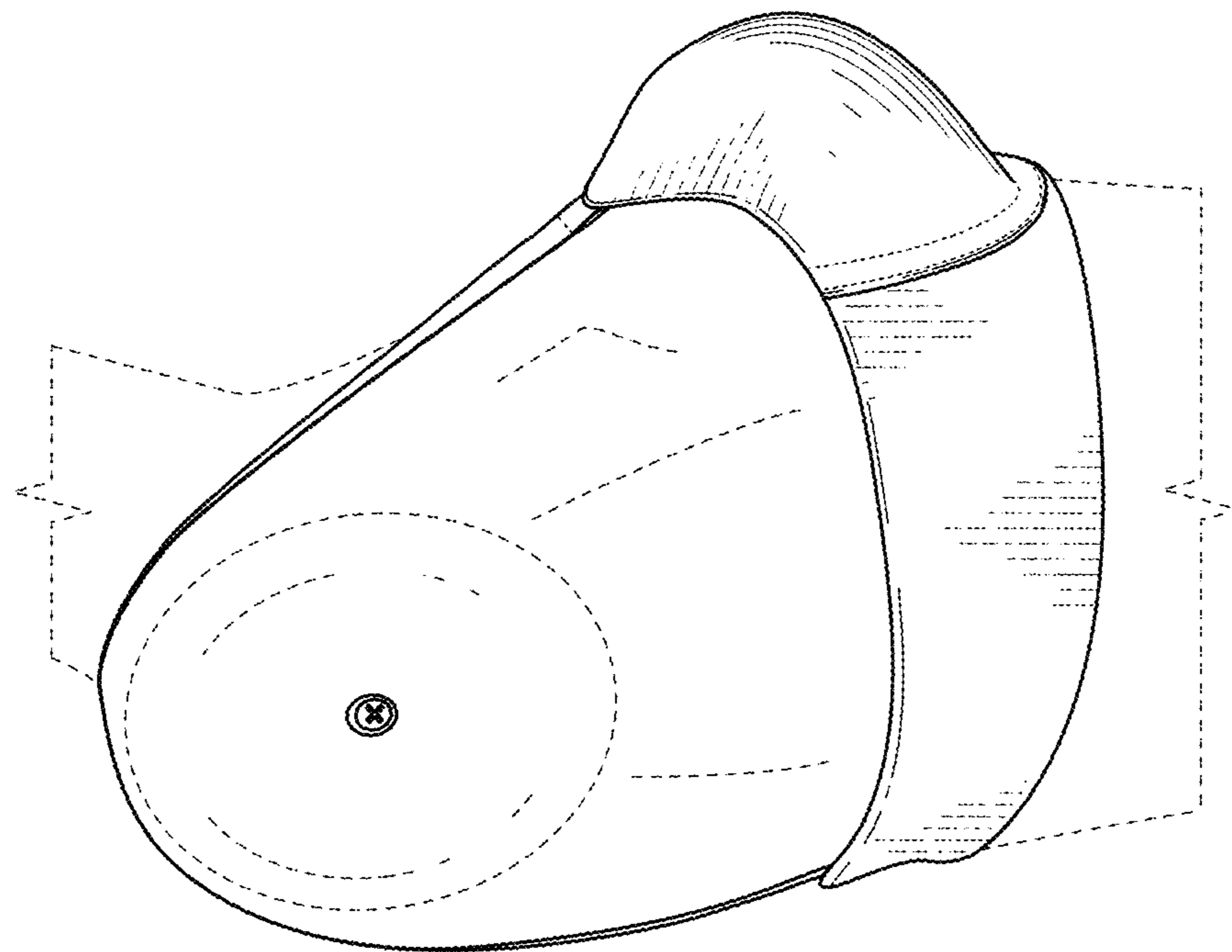

FIG. 5

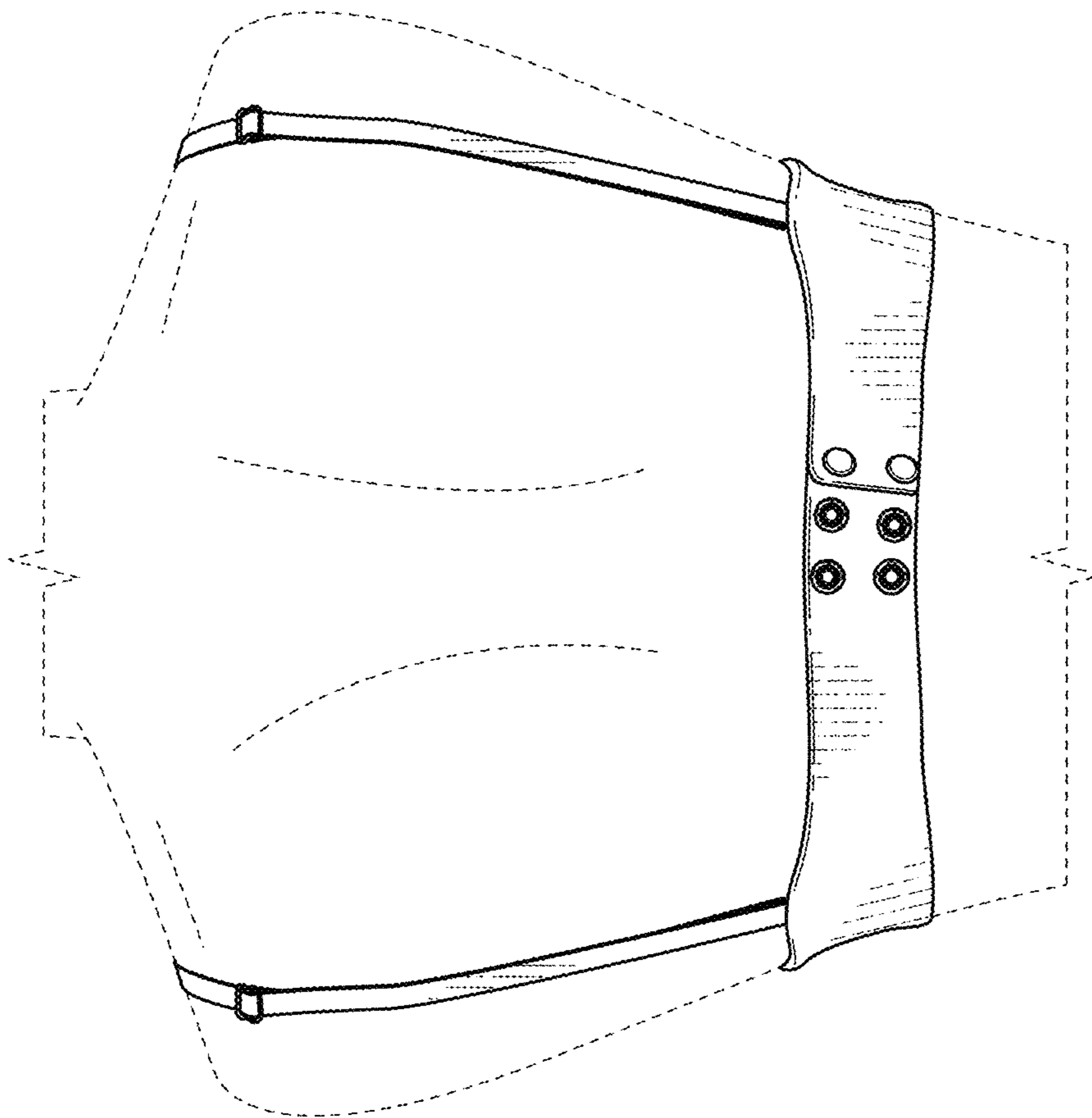

FIG. 7

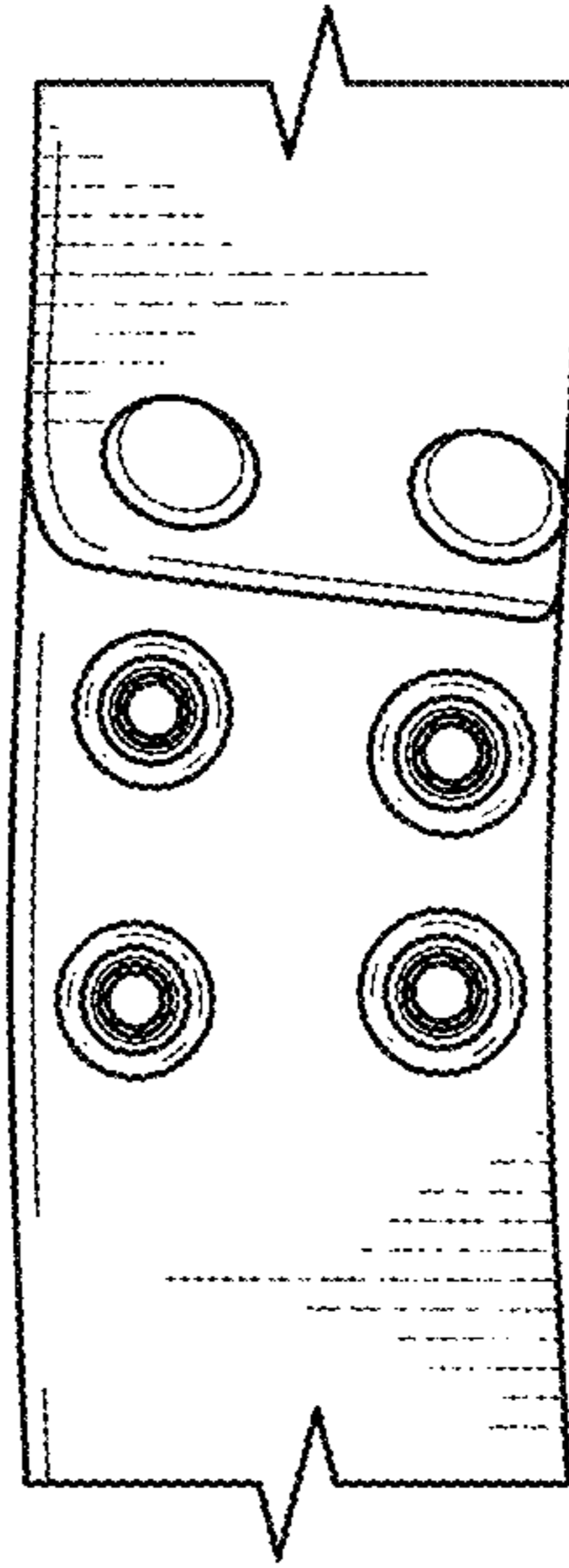

FIG. 8

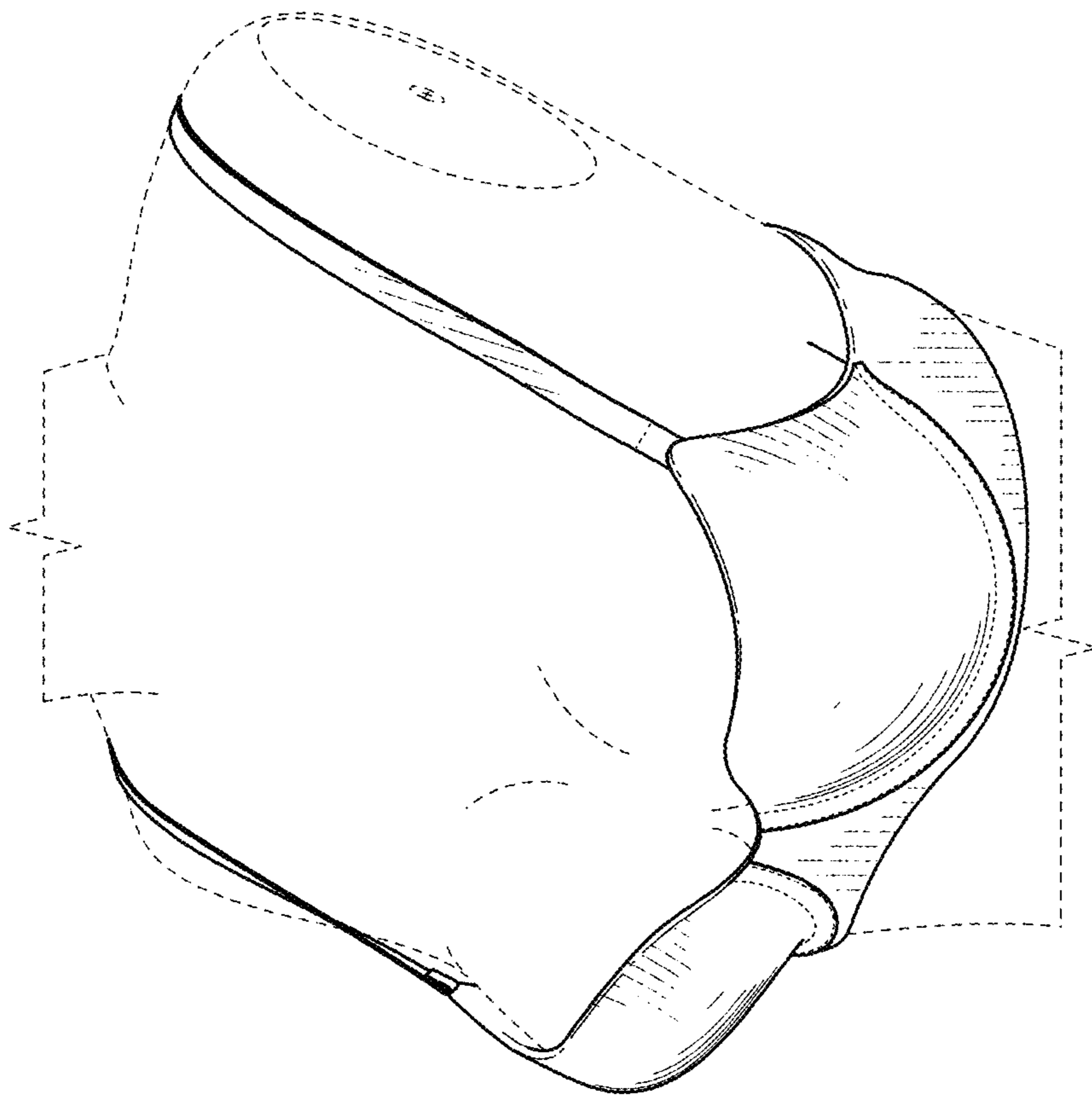

FIG. 9

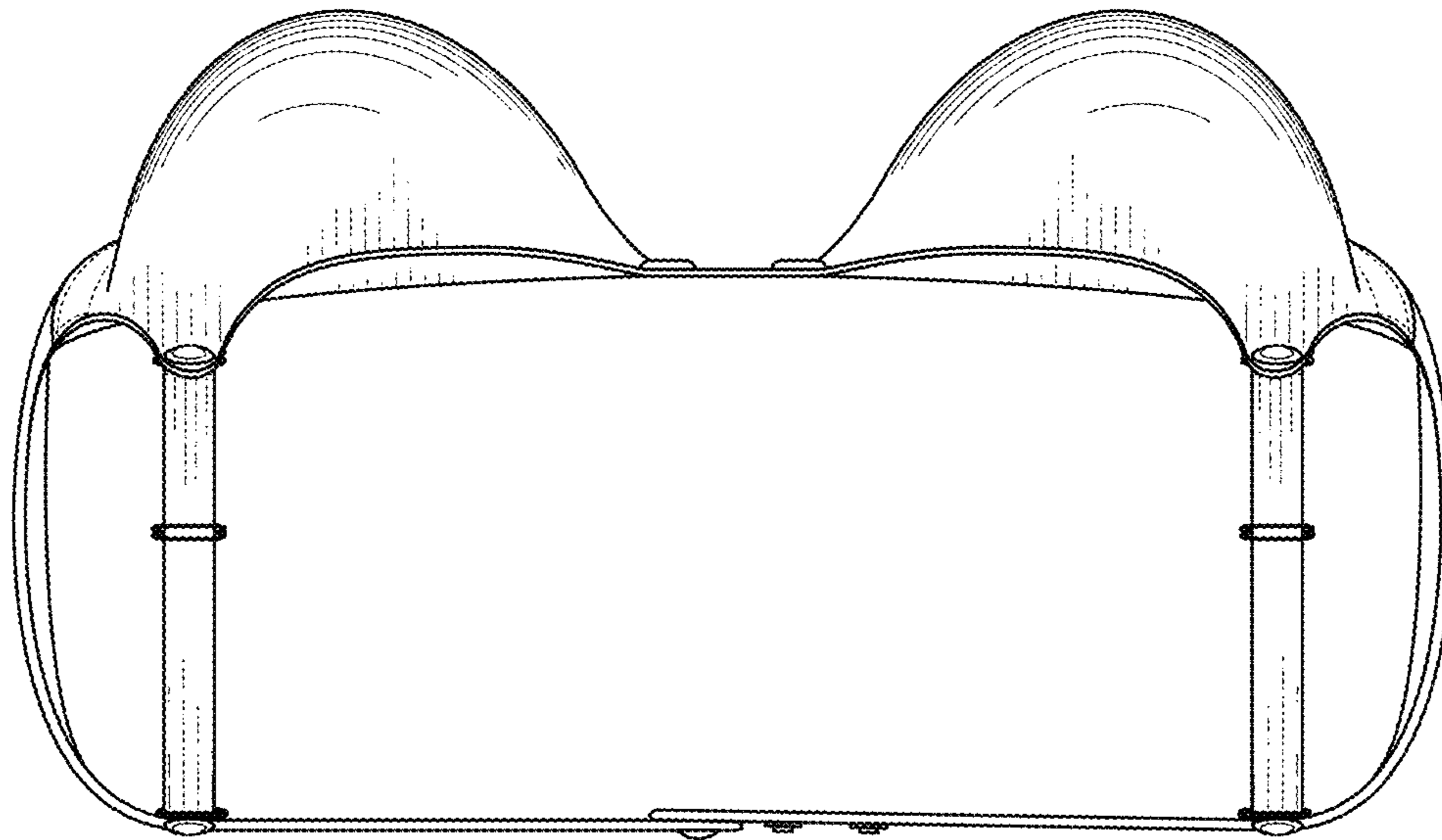

FIG. 10

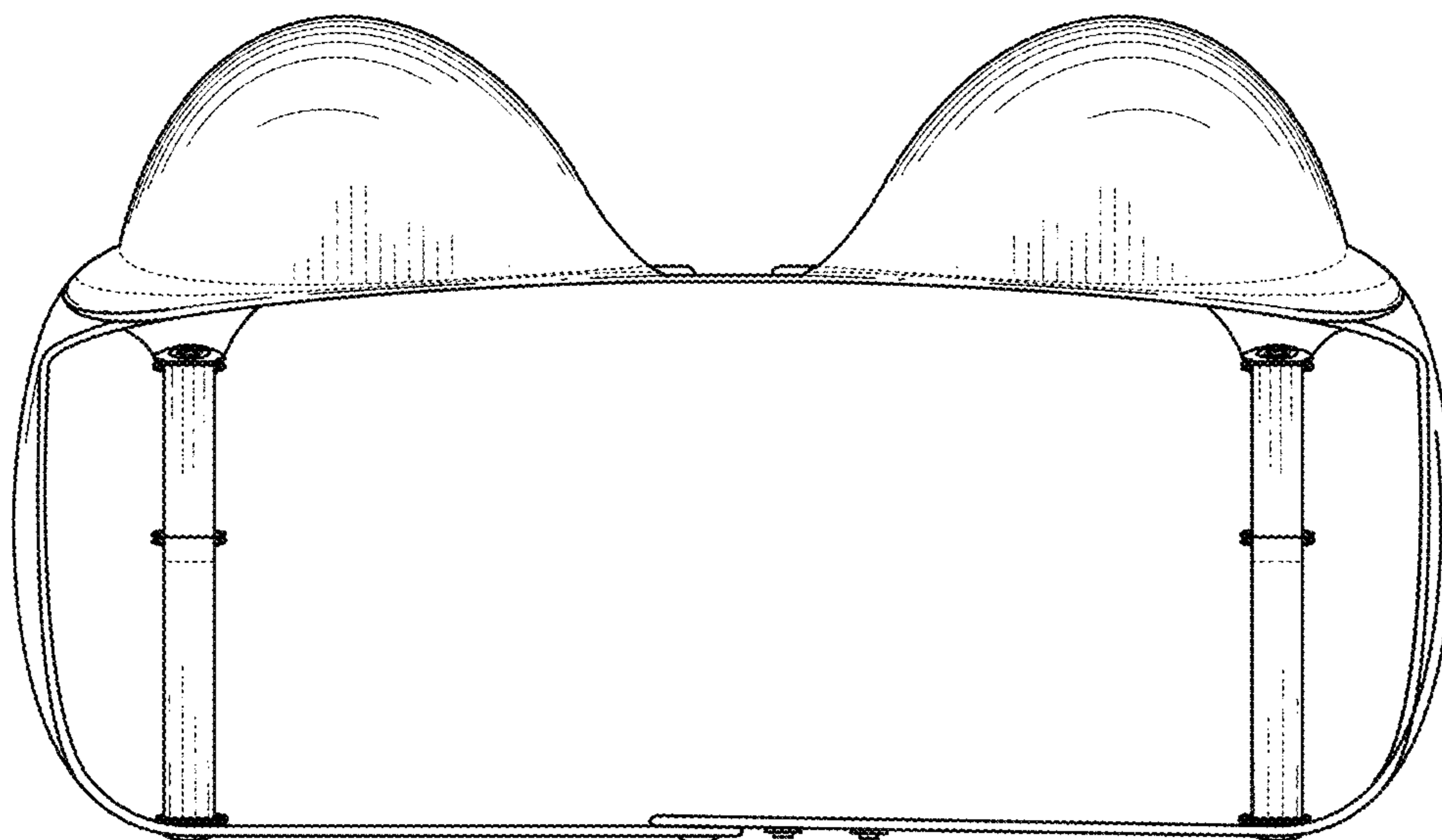

FIG. 11