



US00D798464S

(12) **United States Design Patent**
Crewdson

(10) **Patent No.:** **US D798,464 S**

(45) **Date of Patent:** **** Sep. 26, 2017**

(54) **HEEL PROTECTOR**

(71) Applicant: **TALAR-MADE LIMITED,**
Chesterfield Derbysh (GB)

(72) Inventor: **Bernard Martin Crewdson,**
Chesterfield Derbysh (GB)

(73) Assignee: **TALAR-MADE LIMITED,**
Chesterfield Derbysh (GB)

(**) Term: **15 Years**

(21) Appl. No.: **29/557,665**

(22) Filed: **Mar. 10, 2016**

(51) **LOC (10) Cl.** **24-01**

(52) **U.S. Cl.**
USPC **D24/192**

(58) **Field of Classification Search**
USPC D24/190–192; D29/120.1, 121.1, 122
CPC A61F 5/0109; A61F 13/061; A61F 2/7812;
A61F 5/0106; A61F 2002/7818; A61F
5/0111; A61F 13/066
See application file for complete search history.

(56) **References Cited**

U.S. PATENT DOCUMENTS

D352,784 S *	11/1994	Cohen	D2/919
D363,780 S *	10/1995	Darby	D24/192
D412,581 S *	8/1999	Brennan	D24/192
D435,294 S *	12/2000	Pior	D24/192
D453,969 S *	2/2002	Callsen	D24/192
D455,836 S *	4/2002	Lammers	D24/192
D473,654 S *	4/2003	Iglesias	D24/192
D481,798 S *	11/2003	Slautterback	D24/192
D552,743 S *	10/2007	Verkade	D24/192
D634,438 S *	3/2011	Hu	D24/192

8,409,123 B2 *	4/2013	Hoffmeier	A61F 5/0113 128/846
D697,628 S *	1/2014	Drey	D24/192
D731,070 S *	6/2015	Benenati	D24/192
2009/0076427 A1 *	3/2009	Ponsi	A61F 5/0111 602/27
2010/0152638 A1 *	6/2010	Ponsi	A61F 5/012 602/23
2013/0066247 A1 *	3/2013	Bird	A61F 5/0111 602/13
2014/0128789 A1 *	5/2014	Chen	A61F 5/0195 602/23
2016/0279006 A1 *	9/2016	Crewdson	A61F 5/05816

* cited by examiner

Primary Examiner — George D Kirschbaum

Assistant Examiner — Jennifer Watkins

(74) *Attorney, Agent, or Firm* — Lee & Hayes, PLLC

(57) **CLAIM**

The ornamental design for a heel protector, as shown and described.

DESCRIPTION

FIG. 1 is a perspective view of a heel protector.
FIG. 2 is a front view of the heel protector of FIG. 1.
FIG. 3 is a back perspective view of the heel protector of FIG. 1 with the point of view being closer to the bottom portion than the top portion.
FIG. 4 is a right-side view of the heel protector of FIG. 1.
FIG. 5 is a left-side view of the heel protector of FIG. 1.
FIG. 6 is a top view of the heel protector of FIG. 1; and,
FIG. 7 is a bottom view of the heel protector of FIG. 1.
The broken lines in the drawings are for the purpose of illustrating portions of a heel protector and form no part of the claim.

1 Claim, 7 Drawing Sheets

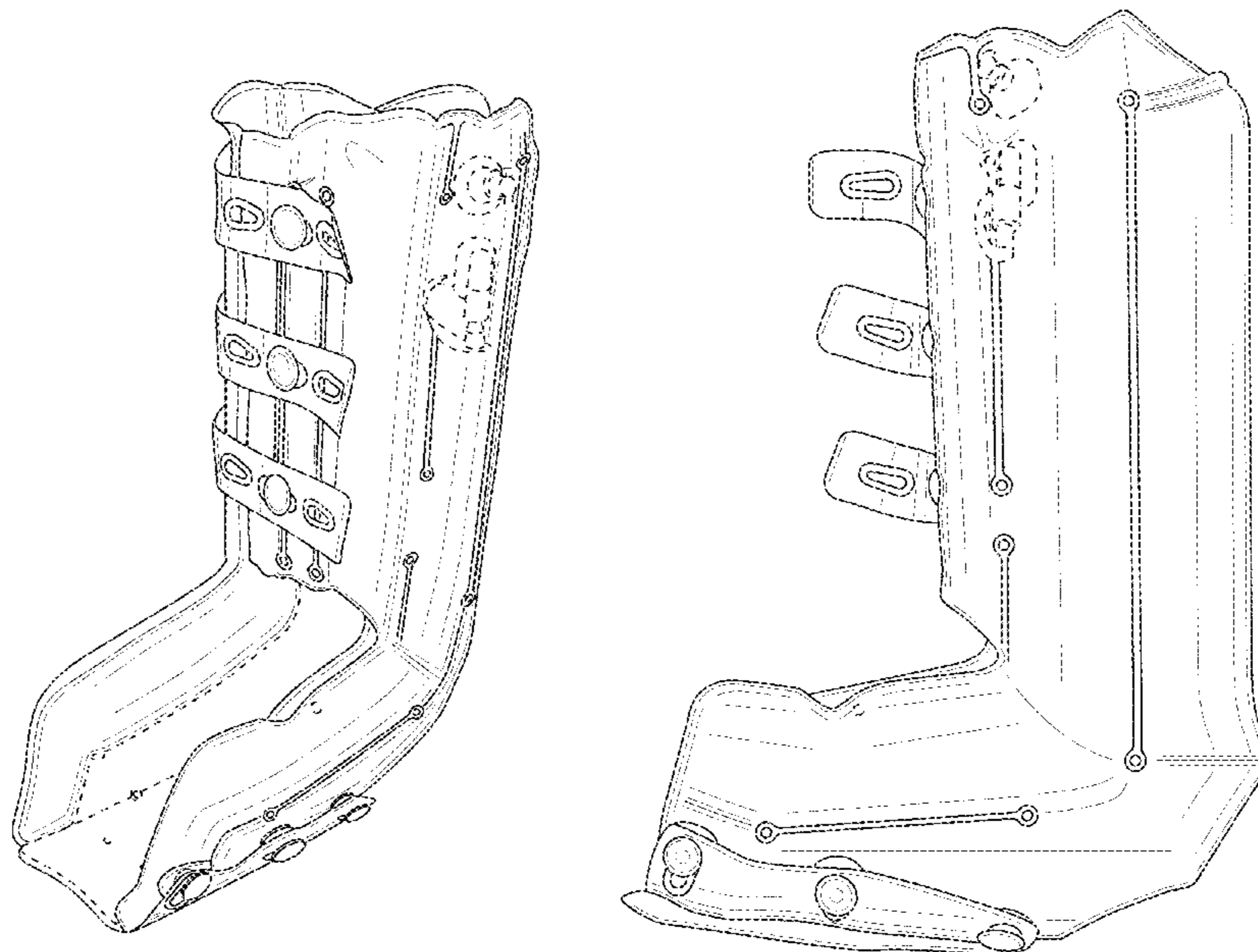

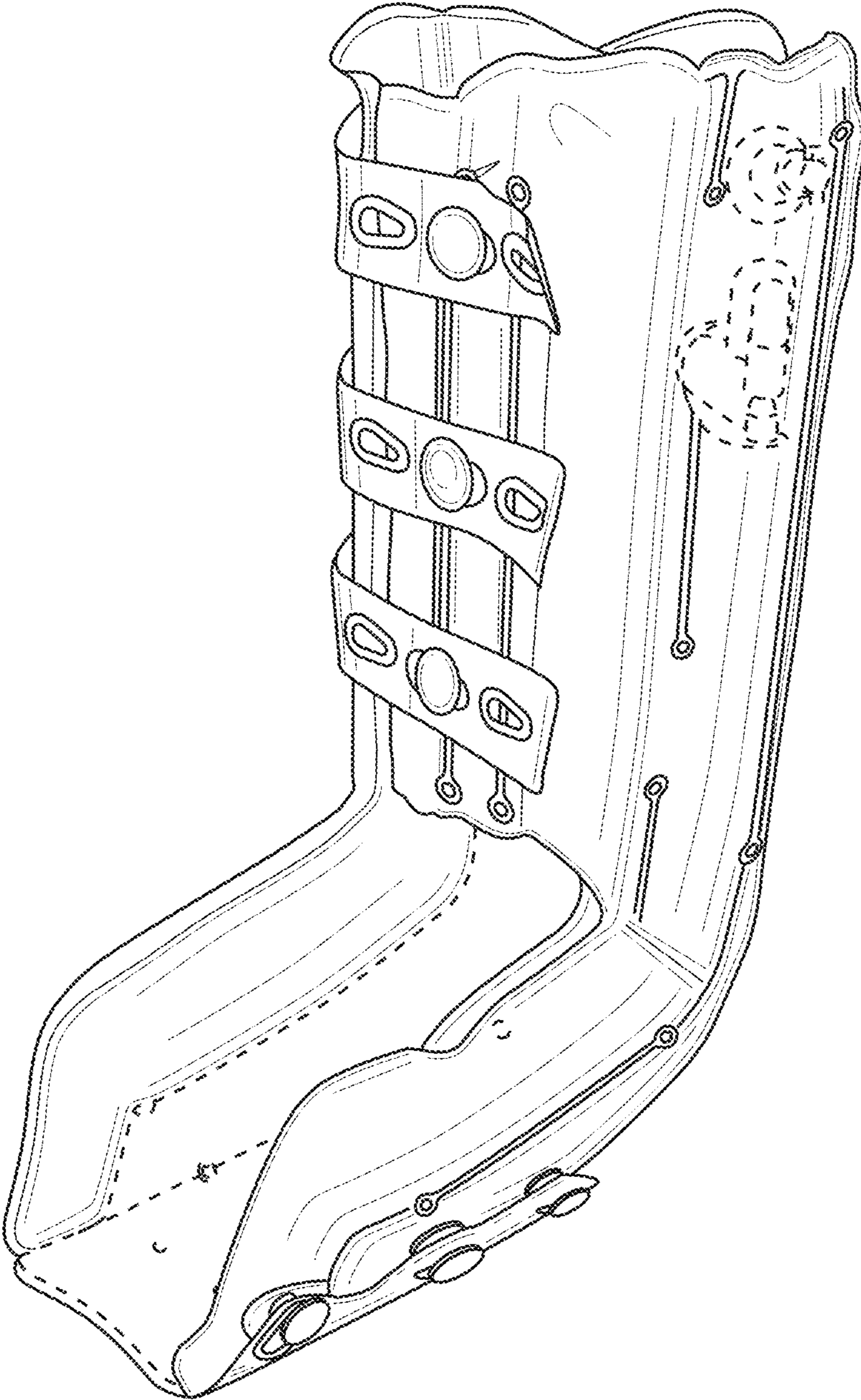

FIG. 1

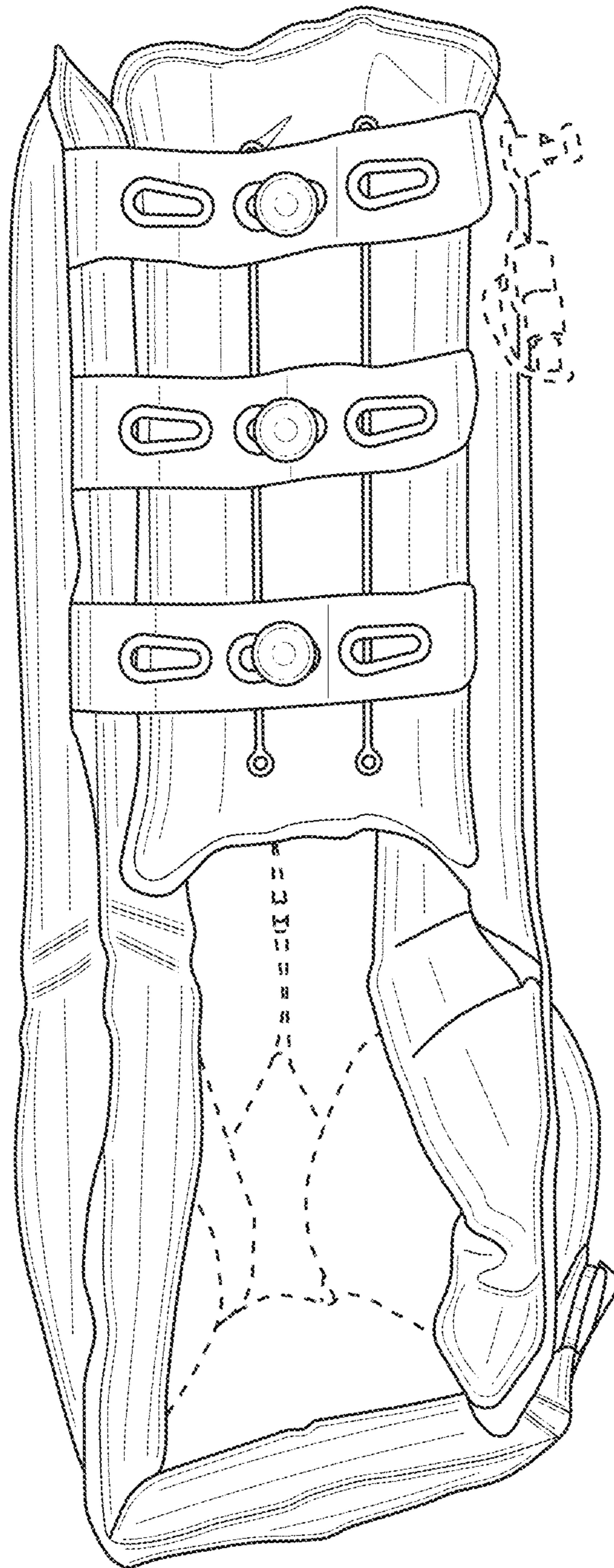

FIG. 2

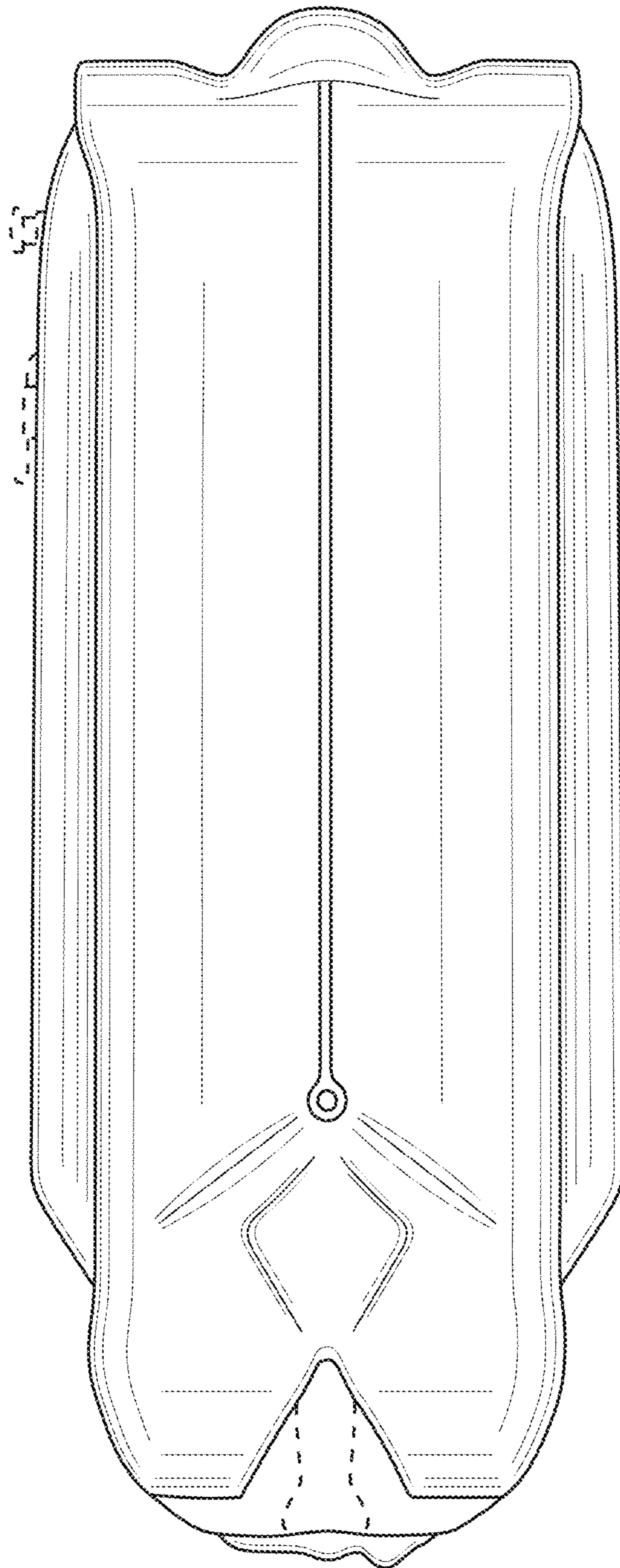

FIG. 3

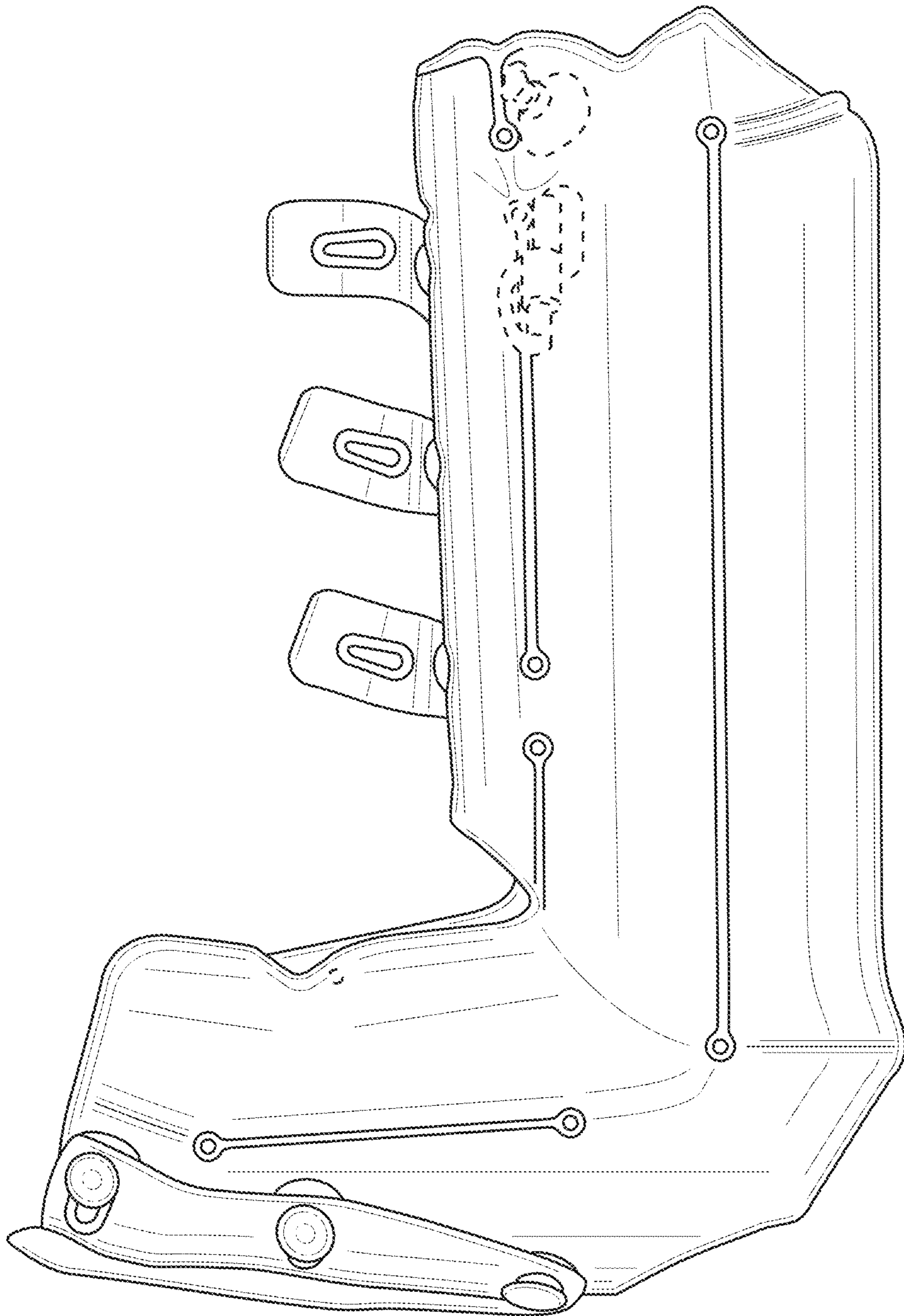

FIG. 4

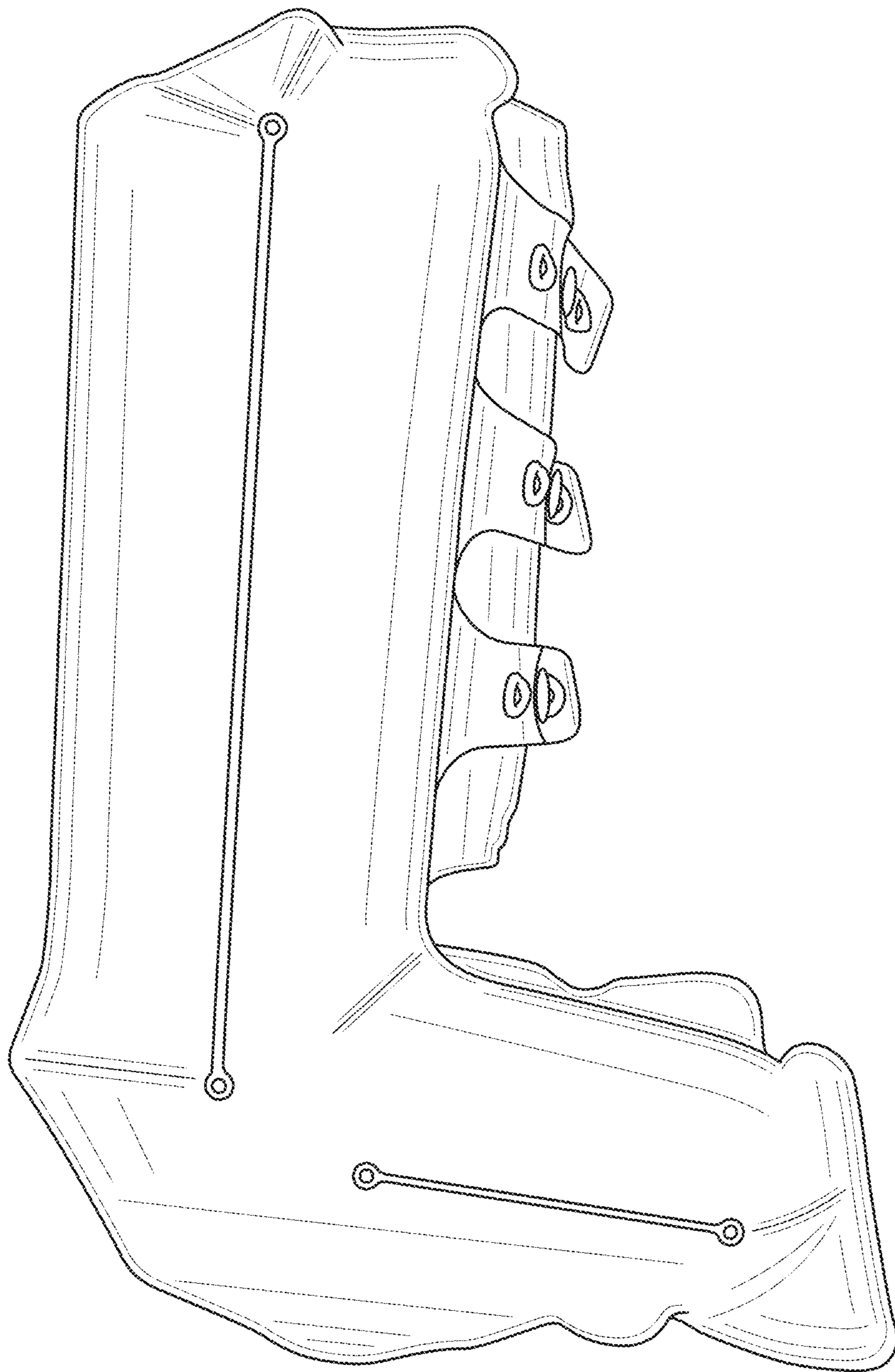

FIG. 5

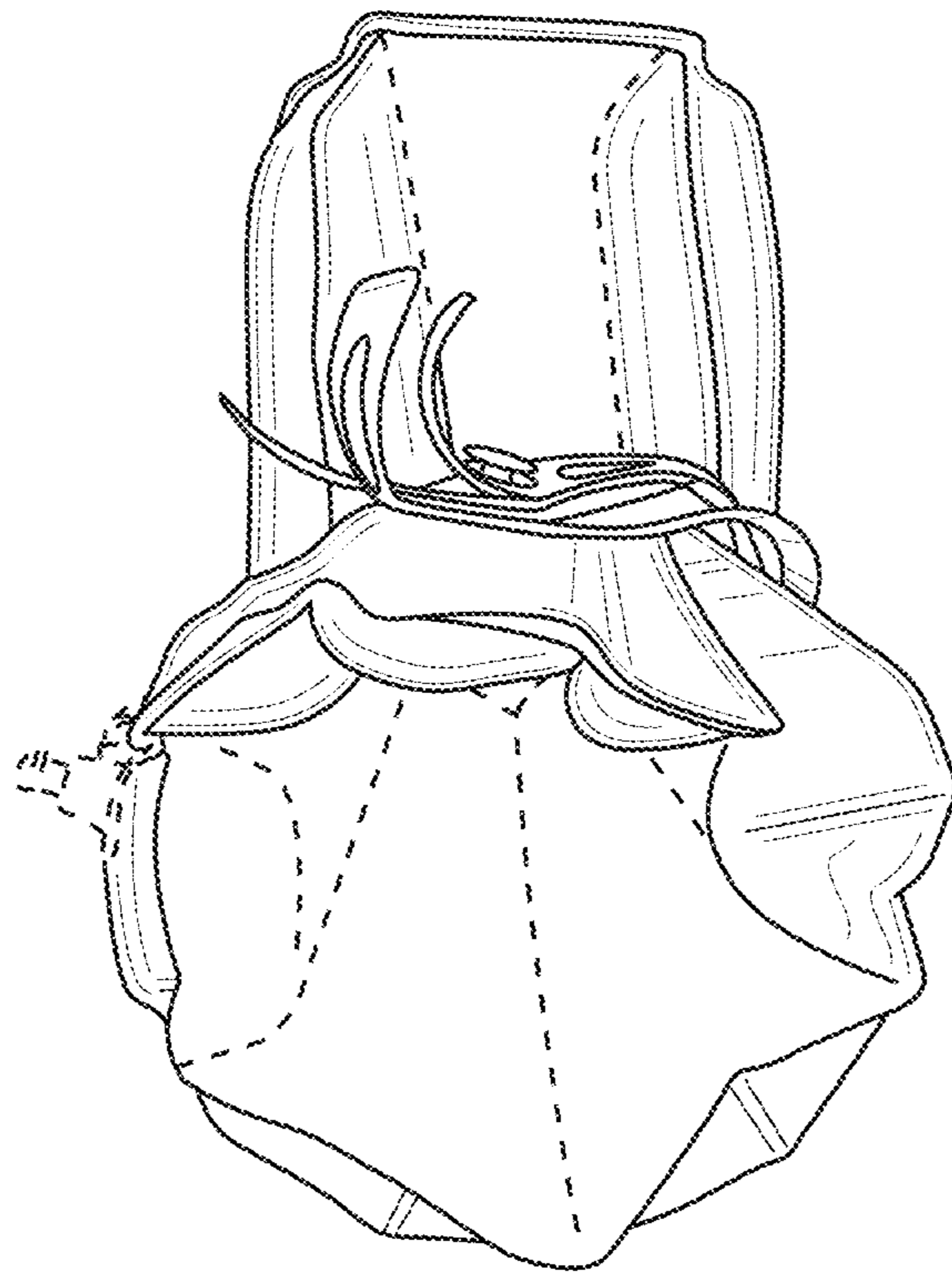

FIG. 6

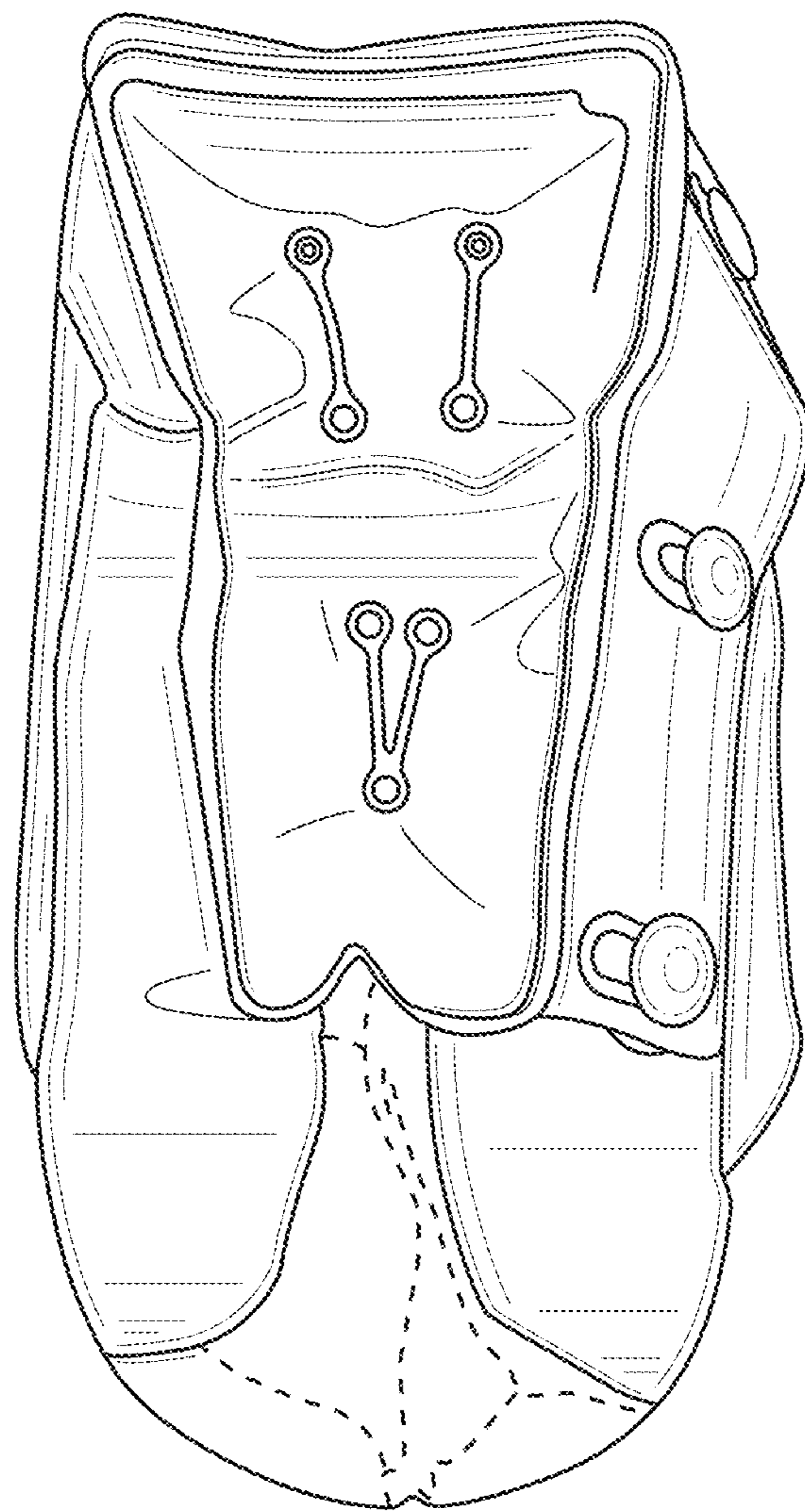

FIG. 7