



US00D798455S

(12) **United States Design Patent** (10) **Patent No.:** **US D798,455 S**  
**Brotman et al.** (45) **Date of Patent:** **\*\* Sep. 26, 2017**

- (54) **ANTERIOR CERVICAL BONE PLATE**
- (71) Applicant: **NuVasive, Inc.**, San Diego, CA (US)
- (72) Inventors: **Michael Brotman**, San Diego, CA (US); **Andrew Wolf**, San Diego, CA (US); **Paul D. Sawin**, San Diego, CA (US)
- (73) Assignee: **NuVasive, Inc.**, San Diego, CA (US)
- (\*\*) Term: **15 Years**
- (21) Appl. No.: **29/591,805**
- (22) Filed: **Jan. 24, 2017**

**Related U.S. Application Data**

- (63) Continuation of application No. 29/504,658, filed on Oct. 8, 2014, now Pat. No. Des. 779,065.
- (51) **LOC (10) Cl.** ..... **24-02**
- (52) **U.S. Cl.**  
USPC ..... **D24/155**
- (58) **Field of Classification Search**  
USPC ..... D24/155-157  
CPC ..... A61B 17/8061; A61B 17/7059; A61B 17/8052; A61B 17/8605; A61B 17/8085; A61B 17/809; A61B 17/8014; A61B 17/8033; A61B 17/8004; A61B 17/888; A61B 17/842; A61B 17/8023; A61B  
(Continued)

(56) **References Cited**

**U.S. PATENT DOCUMENTS**

- 4,488,543 A 12/1984 Tornier
  - 4,794,918 A 1/1989 Wolter
- (Continued)

**FOREIGN PATENT DOCUMENTS**

- AU 201121861 A1 9/2011
  - CN 2477152 Y 2/2002
- (Continued)

*Primary Examiner* — Charles Hanson  
(74) *Attorney, Agent, or Firm* — Jennifer Russell; Bradley Arant Boult Cummings

(57) **CLAIM**

The ornamental design for an anterior cervical bone plate, substantially as shown and described.

**DESCRIPTION**

FIG. 1 is a perspective view of an anterior cervical bone plate showing our new design;  
 FIG. 2 is a first side view thereof;  
 FIG. 3 is a first end view thereof;  
 FIG. 4 is a top view thereof;  
 FIG. 5 is a bottom view thereof;  
 FIG. 6 is a perspective view of a second embodiment of an anterior cervical bone plate;  
 FIG. 7 is a first side view thereof;  
 FIG. 8 is a first end view thereof;  
 FIG. 9 is a top view thereof;  
 FIG. 10 is a bottom view thereof;  
 FIG. 11 is a perspective view of a third embodiment of an anterior cervical bone plate;  
 FIG. 12 is a first side view thereof;  
 FIG. 13 is a first end view thereof;  
 FIG. 14 is a top view thereof;  
 FIG. 15 is a bottom view thereof;  
 FIG. 16 is a perspective view of a fourth alternative embodiment of an anterior cervical bone plate;  
 FIG. 17 is a first side view thereof;  
 FIG. 18 is a first end view thereof;  
 FIG. 19 is a top view thereof; and,  
 FIG. 20 is a bottom view thereof.

The broken line showing is included for the purpose of illustrating environment and forms no part of the claimed design.

**1 Claim, 12 Drawing Sheets**

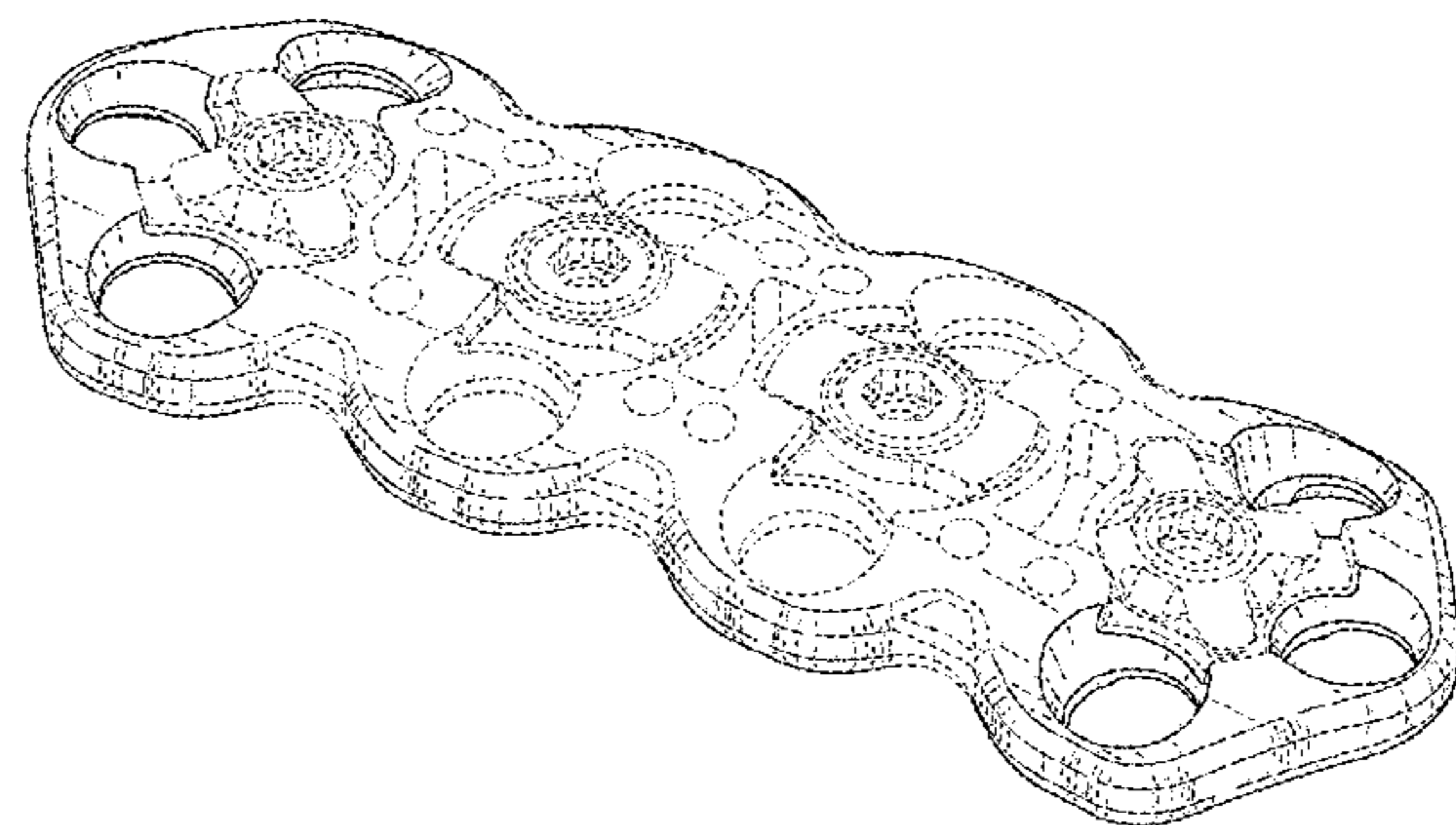
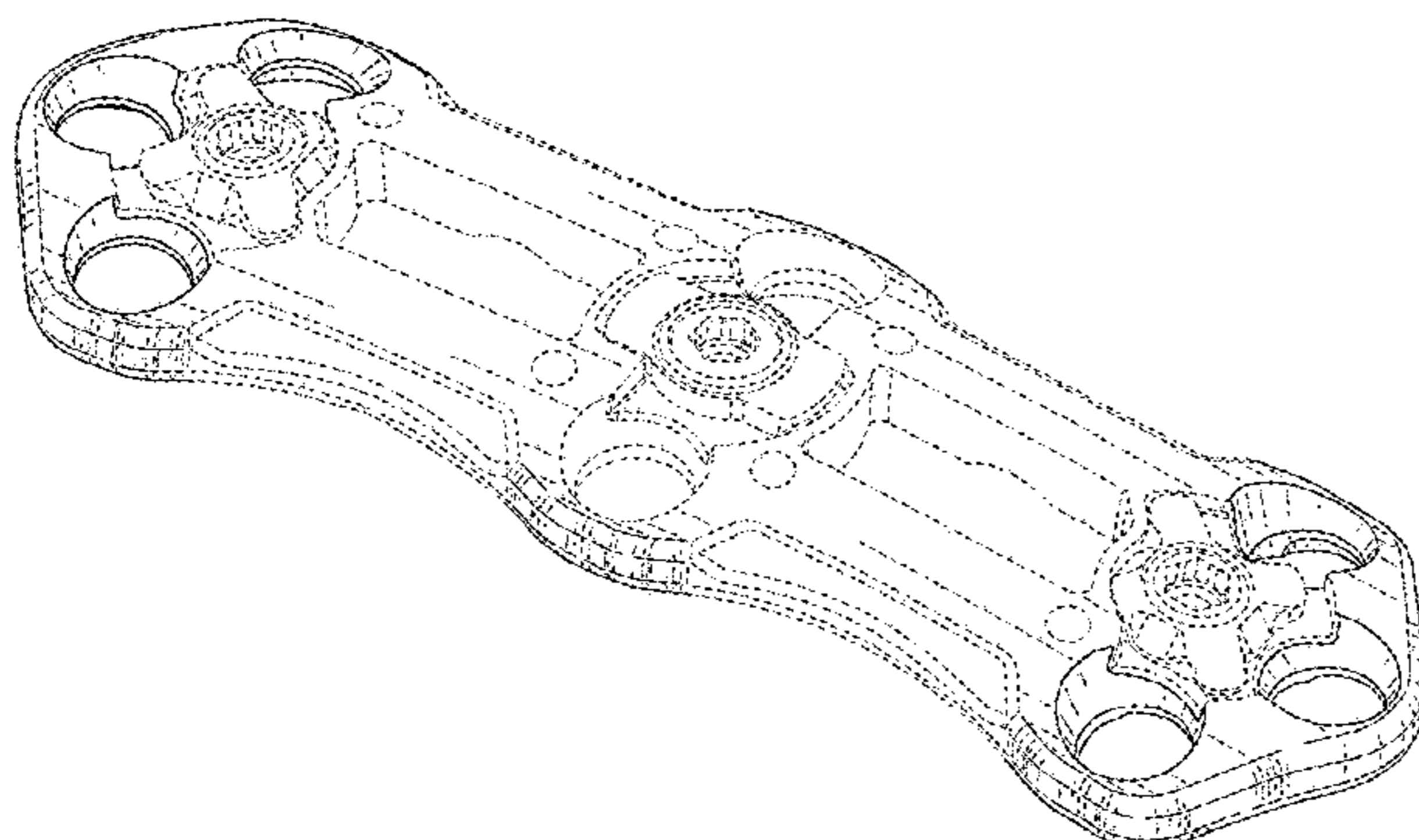

(58) **Field of Classification Search**  
 CPC . 17/8009; A61B 17/86; A61B 17/1739; A61B  
 17/8066; A61B 17/1671; A61B 17/1757;  
 A61B 17/8071; A61B 17/176; A61B  
 2017/1782; A61B 2017/1775  
 See application file for complete search history.

(56) **References Cited**  
 U.S. PATENT DOCUMENTS

5,127,914 A 7/1992 Calderale  
 5,364,399 A 11/1994 Lowery  
 5,380,324 A 1/1995 Mueller  
 5,527,311 A 6/1996 Procter  
 5,601,553 A 2/1997 Trebing  
 5,647,872 A 7/1997 Gilbert  
 5,681,311 A 10/1997 Foley  
 5,735,853 A 4/1998 Olerud  
 5,766,254 A 6/1998 Gelbard  
 5,951,558 A 9/1999 Fiz  
 6,136,002 A 10/2000 Shih  
 6,193,721 B1 2/2001 Michelson  
 6,206,883 B1 3/2001 Tunc  
 D440,311 S 4/2001 Michelson  
 6,235,034 B1 5/2001 Bray  
 D449,692 S 10/2001 Michelson  
 6,336,930 B1 1/2002 Stalcup  
 6,406,478 B1 6/2002 Kuo  
 6,413,259 B1 7/2002 Lyons  
 6,423,069 B1 7/2002 Sellers  
 6,488,685 B1 12/2002 Manderson  
 6,503,250 B2 1/2003 Paul  
 6,506,191 B1 1/2003 Joos  
 6,558,423 B1 5/2003 Michelson  
 6,623,486 B1 9/2003 Weaver  
 6,669,700 B1 12/2003 Farris  
 6,730,127 B2 5/2004 Michelson  
 6,740,088 B1 5/2004 Kozak  
 6,793,658 B2 9/2004 LeHuec  
 6,866,665 B2 3/2005 Orbay  
 6,872,210 B2 3/2005 Hearn  
 6,890,335 B2 5/2005 Grabowski  
 6,945,973 B2 9/2005 Bray  
 6,989,012 B2 1/2006 LeHuec  
 7,004,944 B2 2/2006 Gause  
 7,041,105 B2 5/2006 Michelson  
 7,044,952 B2 5/2006 Michelson  
 7,060,067 B2 6/2006 Needham  
 7,081,119 B2 7/2006 Stihl  
 7,094,239 B1 8/2006 Michelson  
 7,097,645 B2 8/2006 Michelson  
 7,118,573 B2 10/2006 Michelson  
 7,169,150 B2 1/2007 Shipp  
 7,250,053 B2 7/2007 Orbay  
 7,282,053 B2 10/2007 Orbay  
 7,288,094 B2 10/2007 Lindemann  
 7,288,095 B2 10/2007 Baynham  
 7,303,564 B2 12/2007 Freid  
 7,306,605 B2 12/2007 Ross  
 7,318,825 B2 1/2008 Butler  
 D581,055 S 11/2008 Mateyka  
 7,481,829 B2 1/2009 Baynham  
 7,488,327 B2 2/2009 Rathbun  
 D592,946 S 5/2009 Johnson  
 7,527,640 B2 5/2009 Ziolo  
 7,527,641 B2 5/2009 Suh  
 D597,673 S 8/2009 Smisson, III  
 D598,104 S \* 8/2009 Bush, Jr. D24/155  
 D602,589 S \* 10/2009 Bush, Jr. D24/155  
 D603,503 S \* 11/2009 Kriska D24/155  
 D603,504 S \* 11/2009 Kriska D24/155  
 D603,505 S \* 11/2009 Kriska D24/155  
 D603,506 S \* 11/2009 Kriska D24/155  
 D603,507 S \* 11/2009 Kriska D24/155  
 D603,508 S \* 11/2009 Kriska D24/155  
 D603,509 S \* 11/2009 Kriska D24/155  
 D603,510 S \* 11/2009 Kriska D24/155

D603,511 S \* 11/2009 Kriska D24/155  
 D603,961 S \* 11/2009 Kriska D24/155  
 D603,962 S \* 11/2009 Kriska D24/155  
 D603,963 S \* 11/2009 Kriska D24/155  
 D603,964 S \* 11/2009 Kriska D24/155  
 7,625,375 B2 12/2009 Garden  
 7,674,279 B2 3/2010 Johnson  
 7,686,808 B2 3/2010 Orbay  
 D615,652 S \* 5/2010 Weiman D24/155  
 7,727,266 B2 6/2010 Lindemann  
 7,740,630 B2 6/2010 Michelson  
 D622,853 S 8/2010 Raven, III  
 7,771,458 B2 8/2010 Biedermann  
 D623,744 S 9/2010 Strnad  
 D623,751 S \* 9/2010 Weiman D24/155  
 7,857,839 B2 12/2010 Duong  
 D630,750 S 1/2011 Graham  
 7,862,597 B2 1/2011 Gause  
 7,875,062 B2 1/2011 Lindemann  
 7,883,510 B2 2/2011 Kim  
 7,905,830 B2 3/2011 Stefanchik  
 7,909,860 B2 3/2011 Rathbun  
 7,914,561 B2 3/2011 Konieczynski  
 7,963,980 B1 6/2011 Freeman  
 7,963,981 B2 6/2011 Binder  
 D643,927 S \* 8/2011 Prasad D24/155  
 7,998,180 B2 8/2011 Erickson  
 8,029,551 B2 10/2011 Running  
 8,052,729 B2 11/2011 Dube  
 8,057,521 B2 11/2011 Smisson, III  
 8,062,296 B2 11/2011 Orbay  
 8,066,750 B2 11/2011 Oi  
 8,109,934 B2 2/2012 Guenther  
 8,114,081 B2 2/2012 Kohut  
 8,162,950 B2 4/2012 Digeser  
 8,167,918 B2 5/2012 Strnad  
 8,216,312 B2 7/2012 Gray  
 8,257,408 B2 9/2012 Johnson  
 8,273,111 B2 9/2012 Amato  
 8,287,574 B2 10/2012 Biyani  
 8,317,842 B2 11/2012 Graham  
 8,348,980 B2 1/2013 Prasad  
 8,353,939 B2 1/2013 Anderson  
 8,361,074 B2 1/2013 Flandry, Jr.  
 8,394,130 B2 3/2013 Orbay  
 8,394,131 B2 3/2013 Wing  
 8,403,969 B2 3/2013 Wallenstein  
 8,419,777 B2 4/2013 Walker  
 8,425,569 B2 4/2013 O'Farrell  
 8,454,667 B2 6/2013 Humphreys  
 8,523,862 B2 9/2013 Murashko, Jr.  
 8,551,144 B2 10/2013 Youssef  
 8,551,145 B2 10/2013 Huddleston, III  
 8,556,944 B2 10/2013 Dube  
 8,562,655 B2 10/2013 Butler  
 8,613,772 B2 12/2013 Bray  
 8,685,069 B2 4/2014 Courtney  
 8,740,915 B2 6/2014 Niederberger  
 8,784,457 B2 7/2014 Graham  
 8,790,378 B2 7/2014 Castaneda  
 8,808,333 B2 8/2014 Kuster  
 8,845,697 B2 9/2014 Montello  
 8,882,813 B2 11/2014 Jones  
 8,906,077 B2 12/2014 Bush, Jr.  
 2002/0062127 A1 5/2002 Schumacher  
 2003/0036759 A1 2/2003 Musso  
 2004/0019353 A1 1/2004 Freid  
 2004/0097936 A1 5/2004 Ebid  
 2004/0153160 A1 8/2004 Carrasco  
 2004/0158250 A1 8/2004 Chappuis  
 2004/0193155 A1 9/2004 Castaneda  
 2005/0015093 A1 1/2005 Suh  
 2005/0033430 A1 2/2005 Powers  
 2005/0049595 A1 3/2005 Suh  
 2005/0101959 A1 5/2005 Mitkovic  
 2005/0107795 A1 5/2005 Morris  
 2005/0187551 A1 8/2005 Orbay  
 2005/0203627 A1 9/2005 Choksey  
 2006/0056613 A1 3/2006 Kim

(56)

References Cited

U.S. PATENT DOCUMENTS

2006/0122605 A1 6/2006 Suh  
 2006/0221247 A1 10/2006 Doyen  
 2006/0235409 A1 10/2006 Blain  
 2006/0293668 A1 12/2006 May  
 2007/0055250 A1 3/2007 Aflatoon  
 2007/0162019 A1 7/2007 Burns  
 2007/0173840 A1 7/2007 Huebner  
 2007/0233108 A1 10/2007 Stalcup  
 2007/0270849 A1 11/2007 Orbay  
 2008/0183172 A1 7/2008 Fritzingler  
 2008/0234753 A1 9/2008 Trieu  
 2008/0306550 A1 12/2008 Matityahu  
 2008/0312699 A1 12/2008 Johnson  
 2009/0043341 A1 2/2009 Tyber  
 2009/0163960 A1 6/2009 Binder  
 2009/0270928 A1 10/2009 Stone  
 2009/0287257 A1 11/2009 Hagen  
 2009/0287258 A1 11/2009 Vannemreddy  
 2010/0016858 A1 1/2010 Michel  
 2010/0016901 A1 1/2010 Robinson  
 2010/0057127 A1 3/2010 McGuire  
 2010/0057134 A1 3/2010 Lowry  
 2010/0087871 A1 4/2010 Loyola  
 2010/0121383 A1 5/2010 Stanaford  
 2010/0152783 A1 6/2010 Borostyankoi  
 2011/0264149 A1 10/2011 Pappalardo  
 2011/0282389 A1 11/2011 Janice  
 2011/0301608 A1 12/2011 Roth  
 2012/0022600 A1 1/2012 Overes  
 2012/0053587 A1 3/2012 Kiritsis  
 2012/0071931 A1 3/2012 Perez-Cruet  
 2012/0130496 A1 5/2012 Duffield  
 2012/0136392 A1 5/2012 Keegan  
 2012/0209334 A1 8/2012 Lewis  
 2012/0277803 A1 11/2012 Remesh  
 2012/0303031 A1 11/2012 Coceancig  
 2013/0006309 A1 1/2013 Lorio  
 2013/0018424 A1 1/2013 Subik  
 2013/0053895 A1 2/2013 Stoll  
 2013/0053898 A1 2/2013 Voisard  
 2013/0072988 A1 3/2013 Hulliger  
 2013/0211463 A1 8/2013 Mizuno  
 2013/0238095 A1 9/2013 Pavento  
 2014/0039498 A1 2/2014 Chatain

FOREIGN PATENT DOCUMENTS

CN 2498996 Y 7/2002  
 CN 1366866 A 9/2002  
 CN 1372869 A 10/2002  
 CN 2517396 Y 10/2002  
 CN 2543495 Y 4/2003  
 CN 2631438 Y 8/2004  
 CN 1748655 A 3/2006  
 CN 2822542 Y 10/2006  
 CN 2882556 Y 3/2007

CN 200980723 Y 11/2007  
 CN 201042458 Y 4/2008  
 CN 201055419 Y 5/2008  
 CN 201260694 Y 6/2009  
 CN 201308534 Y 9/2009  
 CN 201324284 Y 10/2009  
 CN 201586062 U 9/2010  
 CN 101953712 A 1/2011  
 CN 101972162 A 2/2011  
 CN 201759658 U 3/2011  
 CN 201831944 U 5/2011  
 CN 201847761 U 6/2011  
 CN 202044331 U 11/2011  
 CN 102362815 A 2/2012  
 CN 202223333 U 5/2012  
 CN 202342170 U 7/2012  
 CN 202409108 U 9/2012  
 CN 202409123 U 9/2012  
 CN 202409127 U 9/2012  
 CN 202568423 U 12/2012  
 CN 102846363 A 1/2013  
 CN 102871717 A 1/2013  
 CN 202665675 U 1/2013  
 CN 202843762 U 4/2013  
 CN 202843768 U 4/2013  
 CN 202859275 U 4/2013  
 CN 202892074 U 4/2013  
 CN 202942203 U 5/2013  
 CN 202982197 U 6/2013  
 CN 203107261 U 8/2013  
 DE 7915573 U1 5/1979  
 DE 8528003 U1 1/1986  
 DE 9217768 U1 5/1993  
 DE 9217769 U1 5/1993  
 DE 9315148 U1 1/1994  
 DE 4438264 A1 3/1996  
 DE 8213228 U1 1/2000  
 DE 10240653 A1 5/2003  
 DE 20317651 U1 3/2004  
 DE 102006012581 A1 4/2007  
 DE 202009008872 U1 9/2009  
 DE 202011107822 U1 5/2012  
 EP 0542004 A1 5/1993  
 EP 1520545 A1 4/2005  
 EP 2433580 A1 3/2012  
 ES 52078085 T3 12/1995  
 FR 2405062 A1 5/1979  
 FR 2740674 A1 5/1997  
 JP 2010220762 A 10/2010  
 JP 2010233915 A 10/2010  
 KR 20020010449 A 2/2002  
 KR 20050023433 A 3/2005  
 KR 20070022261 A 2/2007  
 KR 100974498 B1 8/2010  
 RU 2011119282 A 11/2012  
 WO WO9722306 A1 6/1997  
 WO WO2004017837 A2 3/2004  
 WO WO2005034780 A1 4/2005  
 WO WO2006022644 A1 3/2006

\* cited by examiner

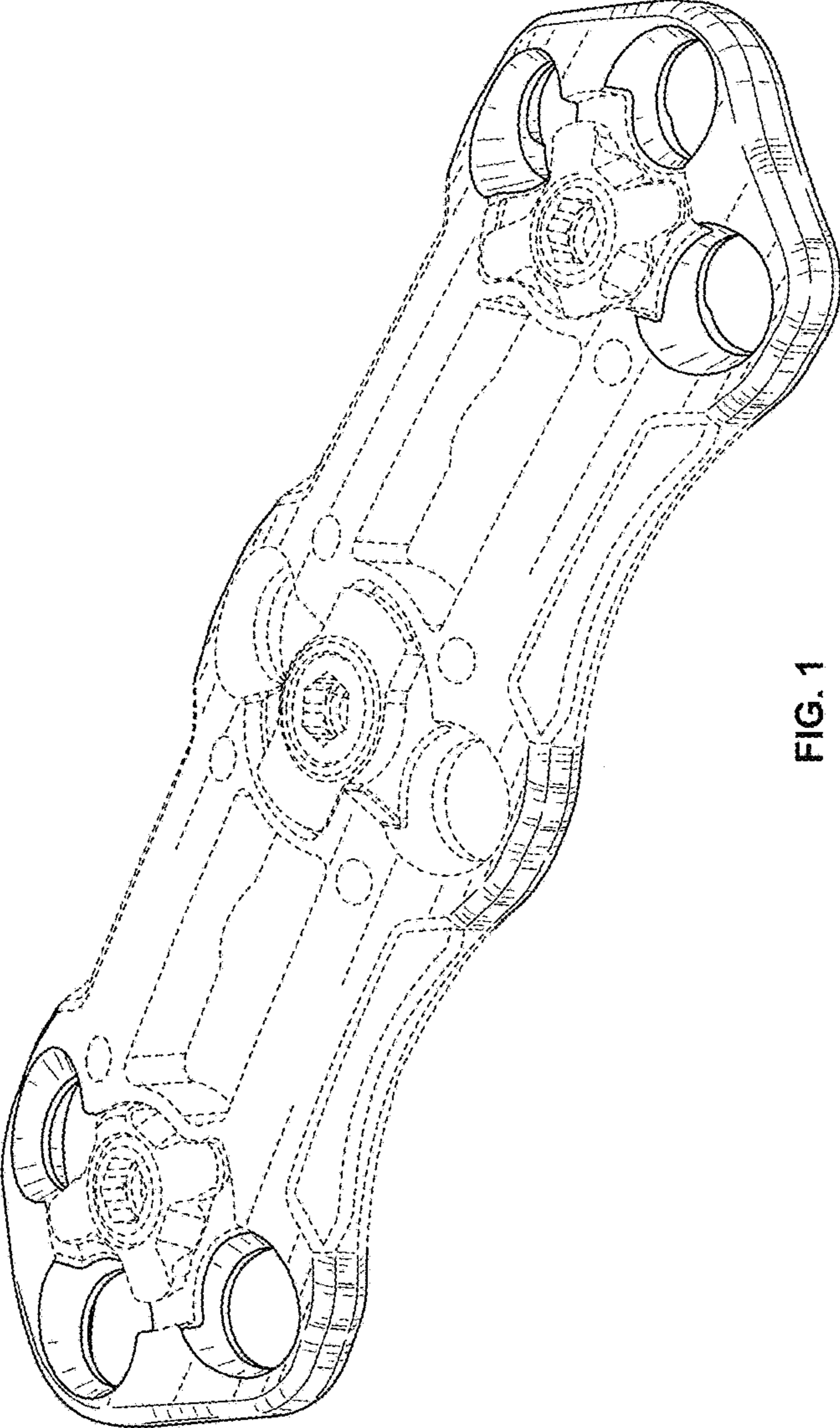

FIG. 1

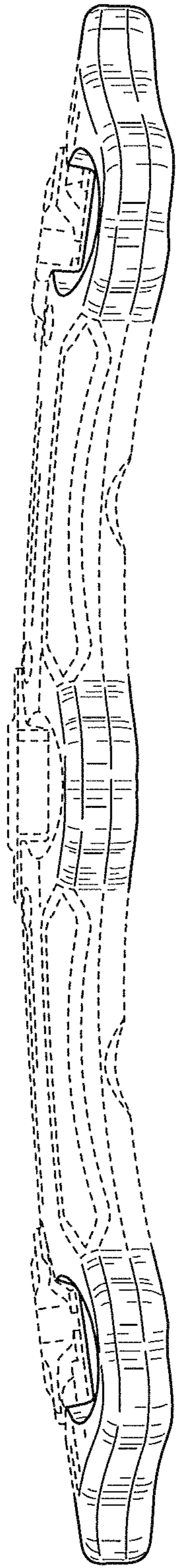

FIG. 2

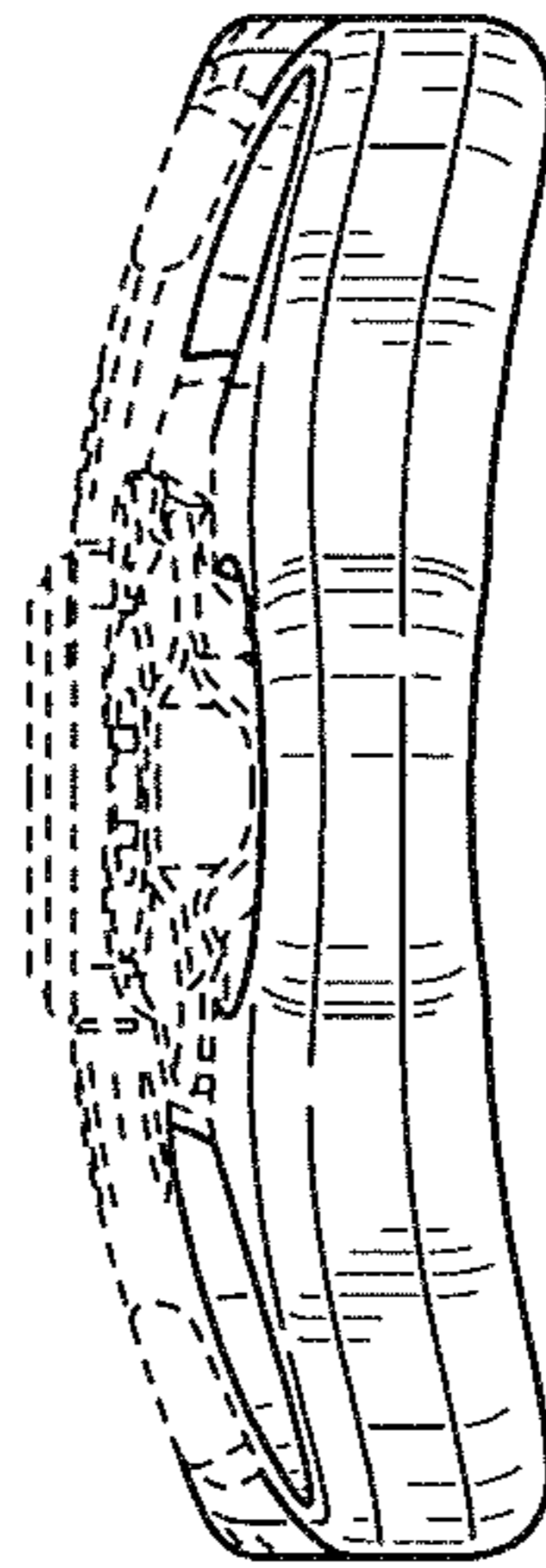

FIG. 3

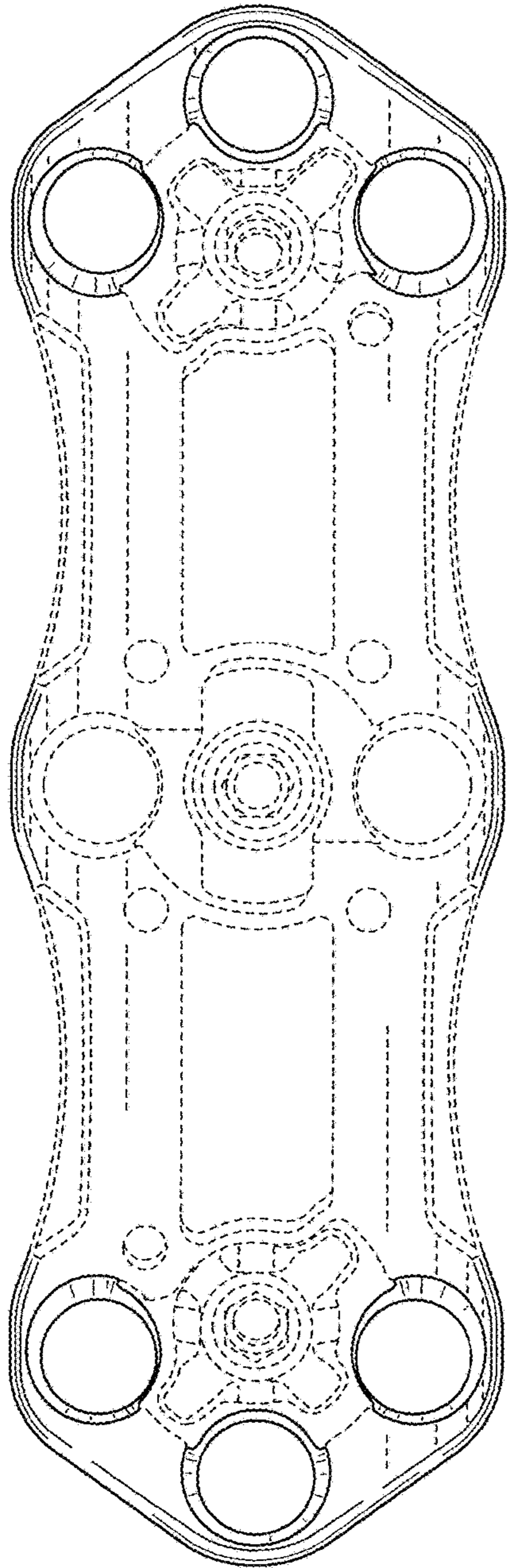

FIG. 4

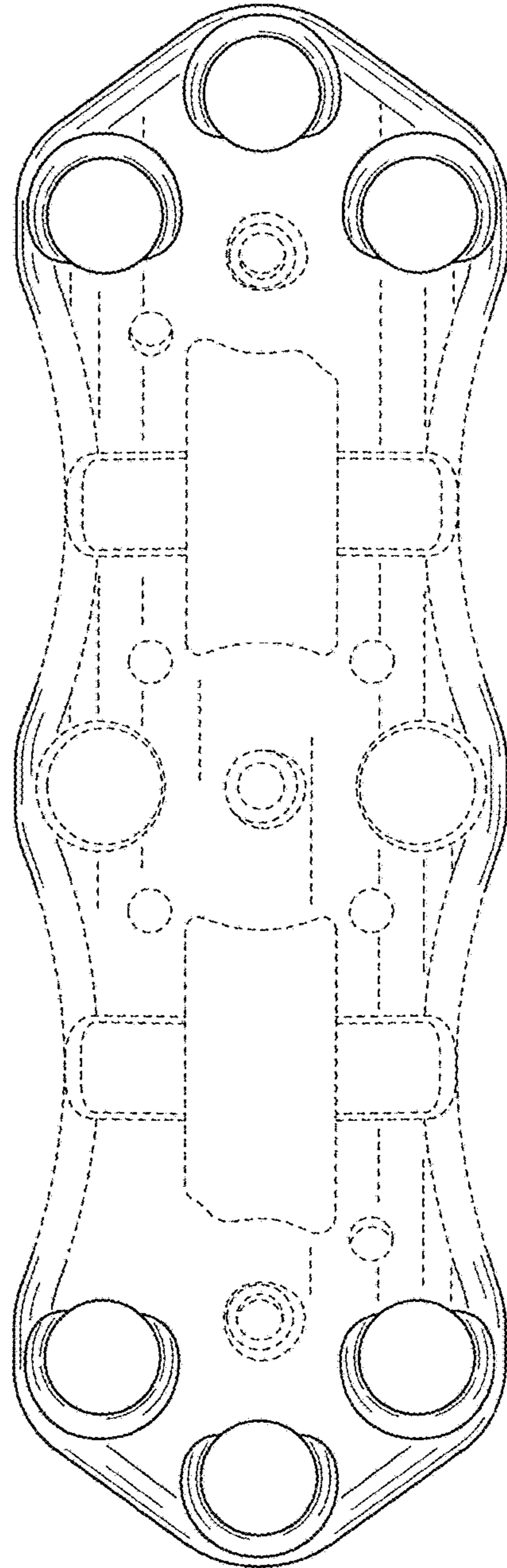

FIG. 5

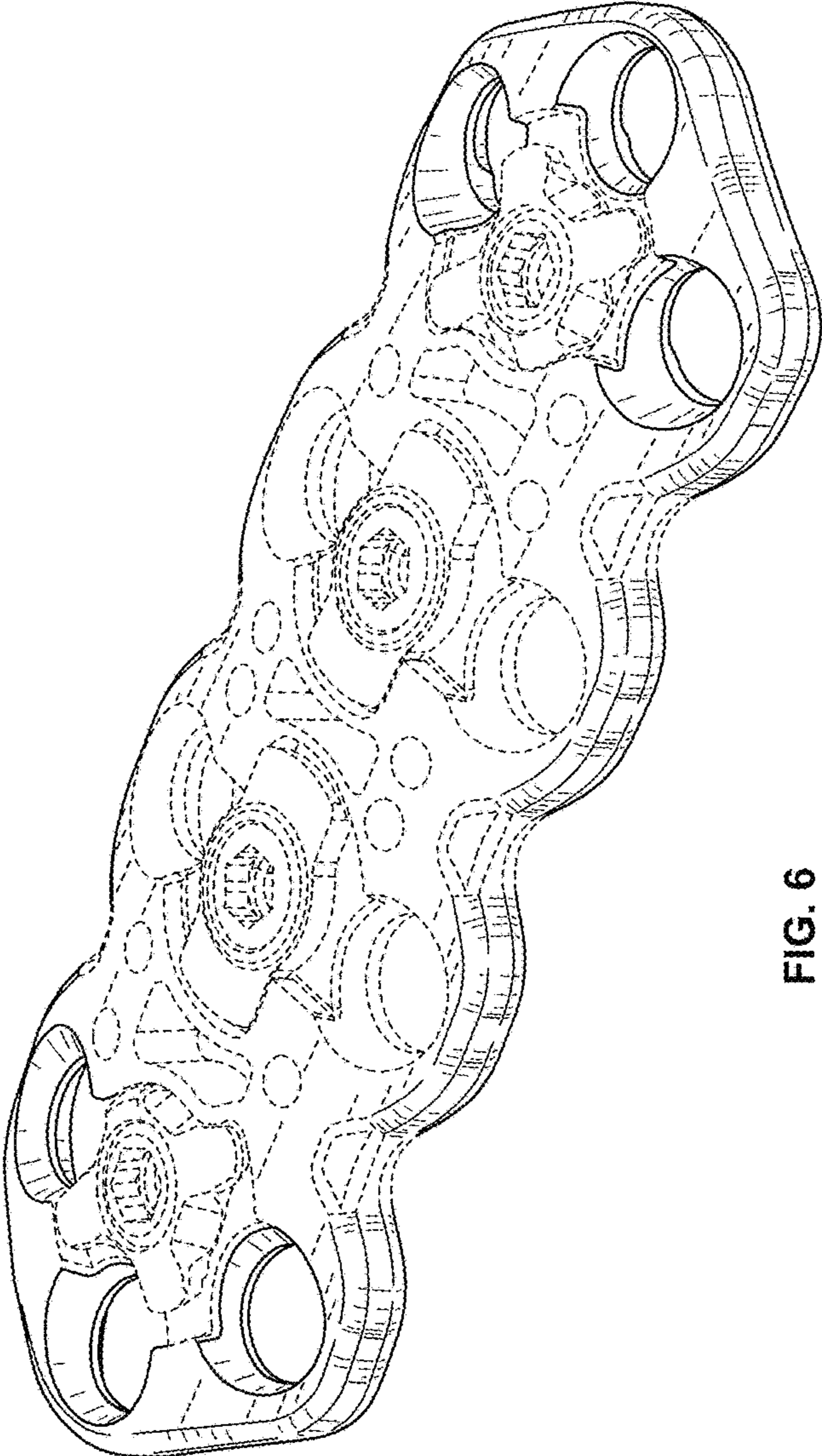

FIG. 6

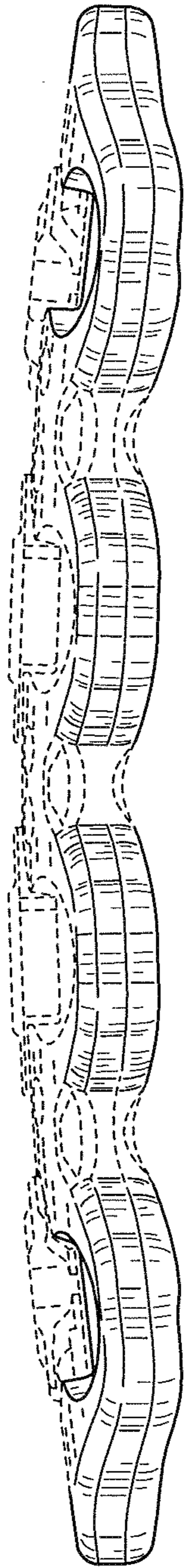

FIG. 7

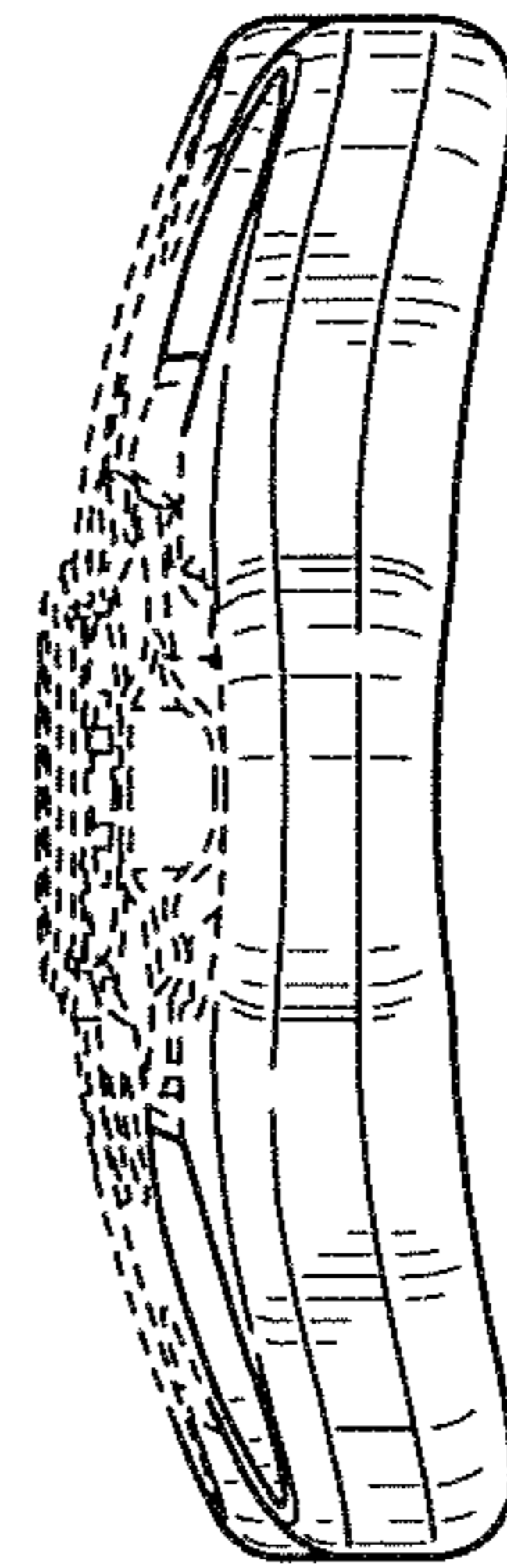

FIG. 8



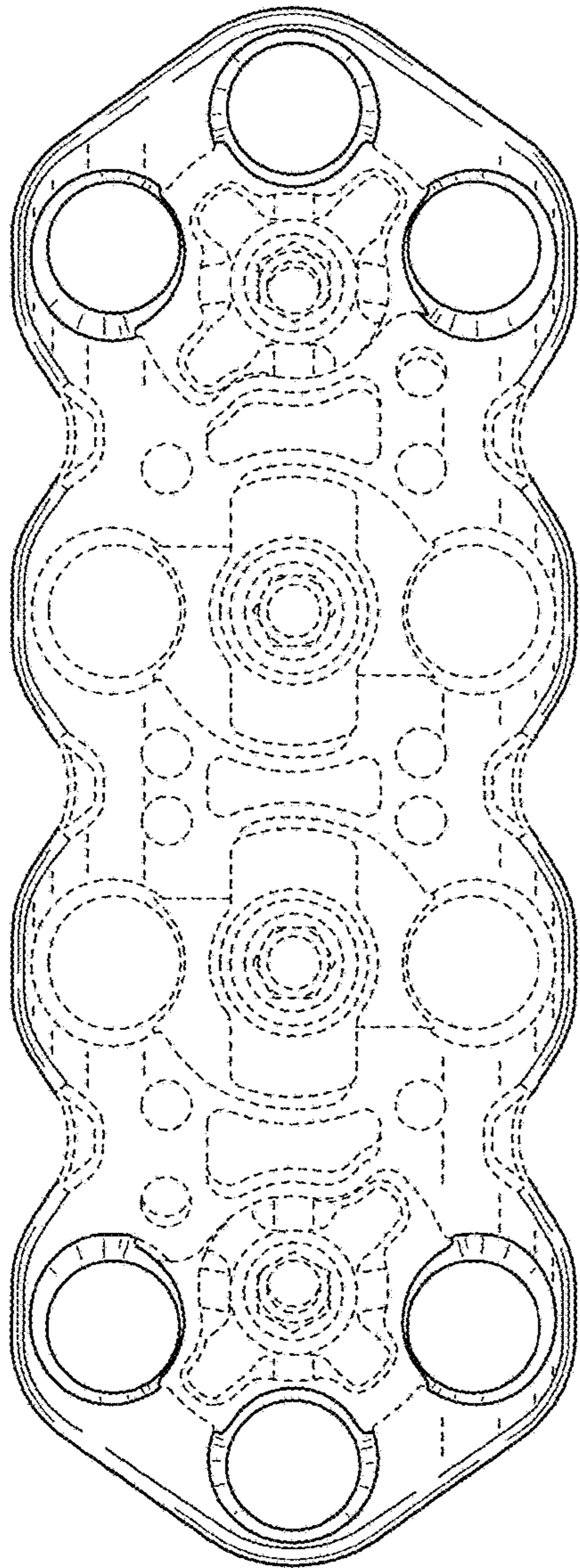

FIG. 9

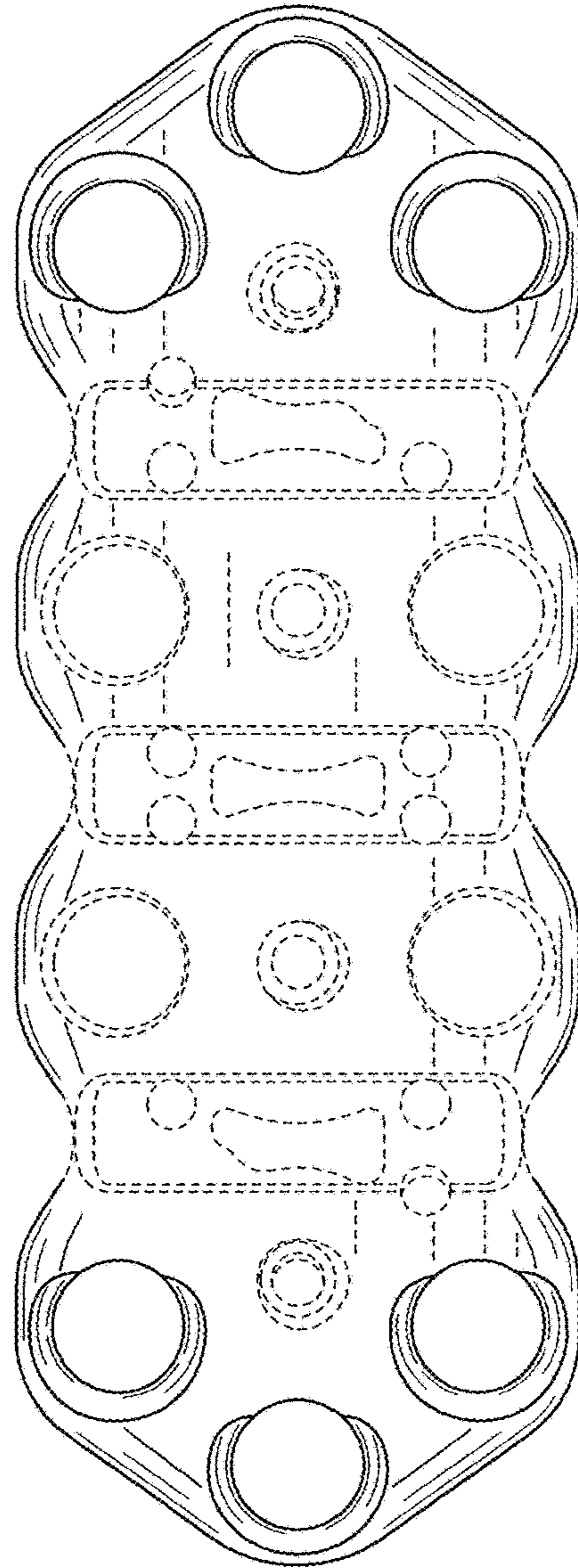

FIG. 10

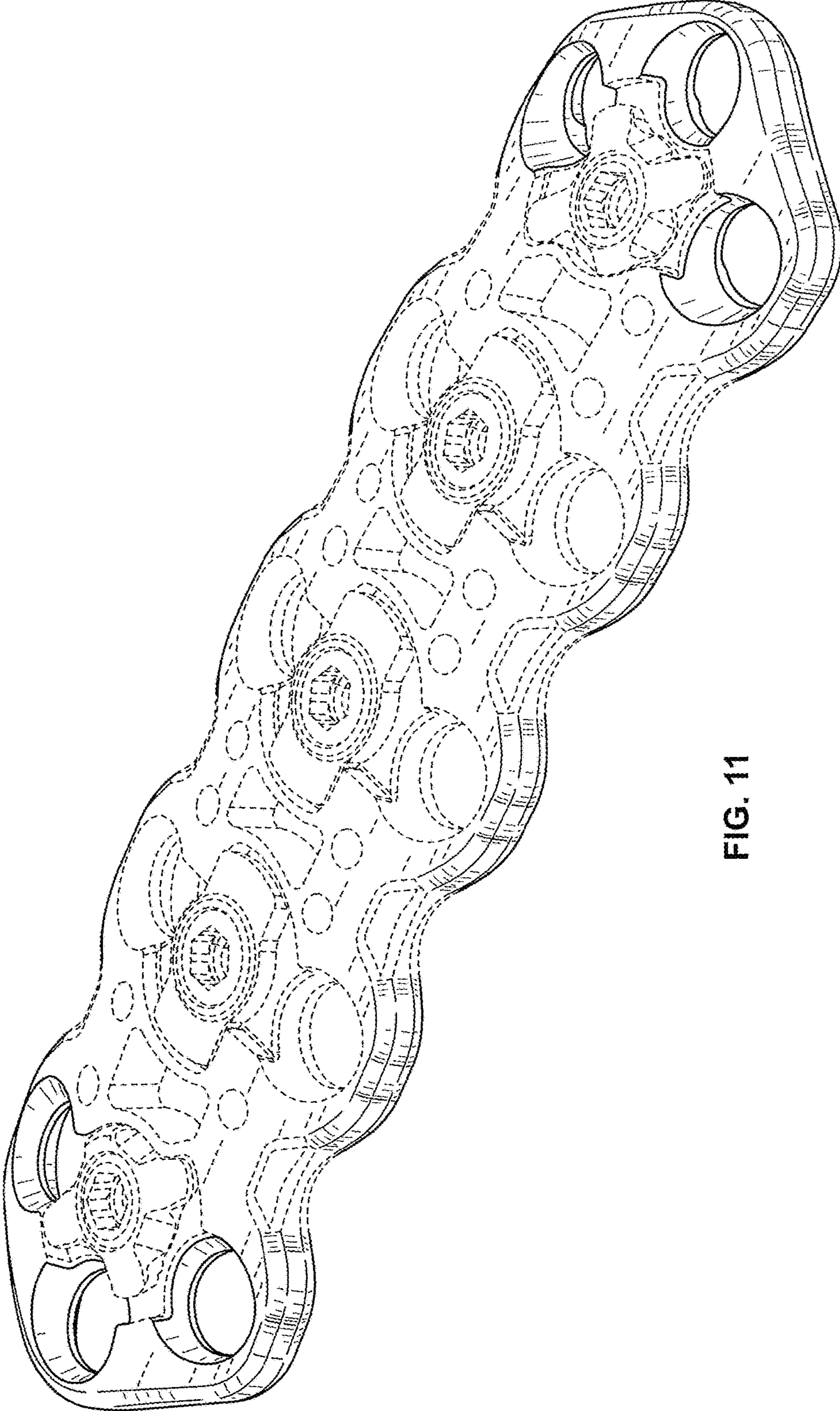

FIG. 11

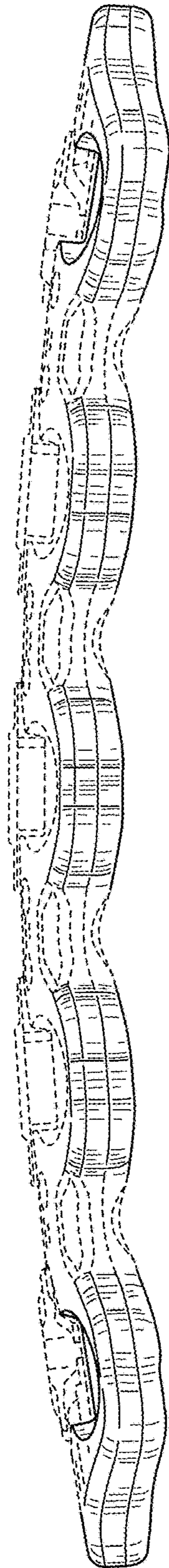

FIG. 12

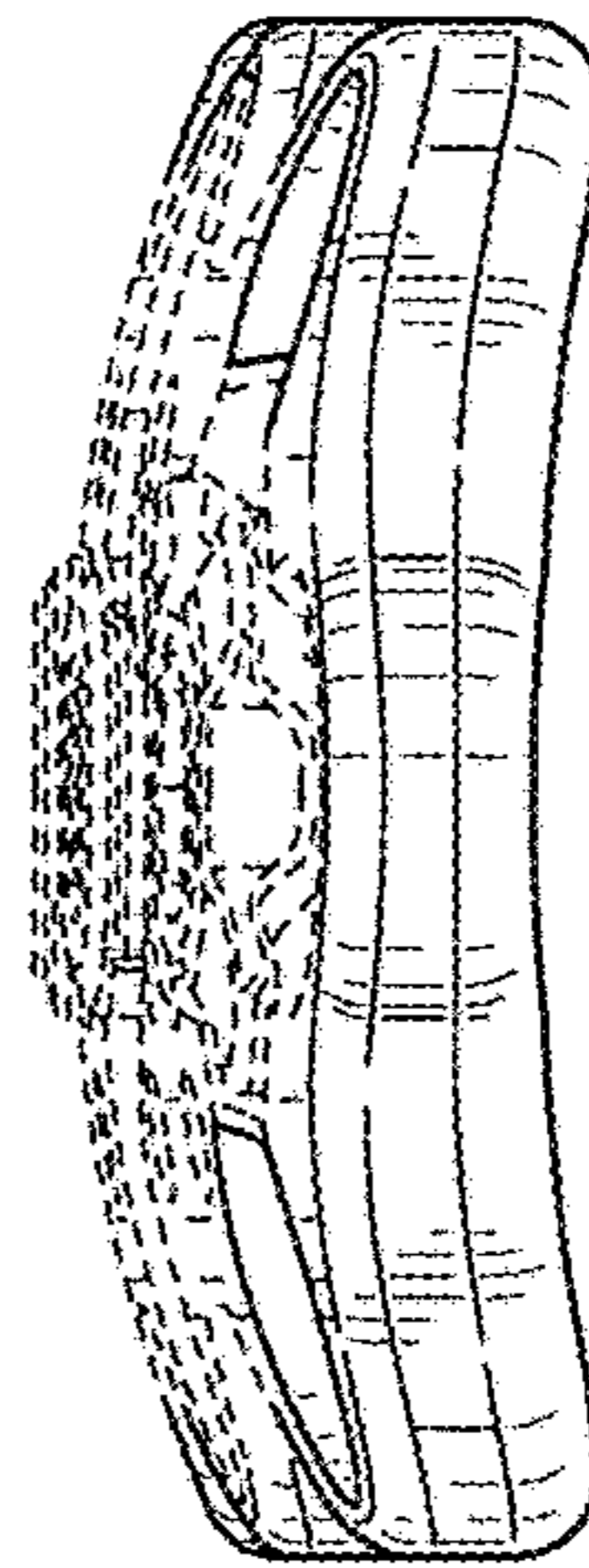

FIG. 13

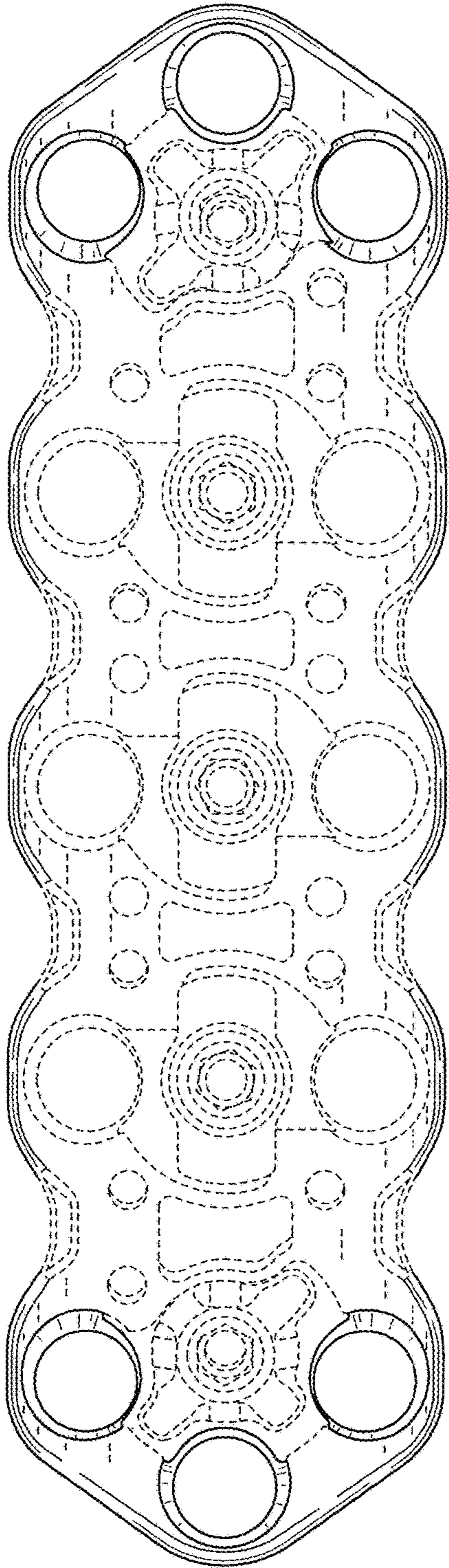

FIG. 14

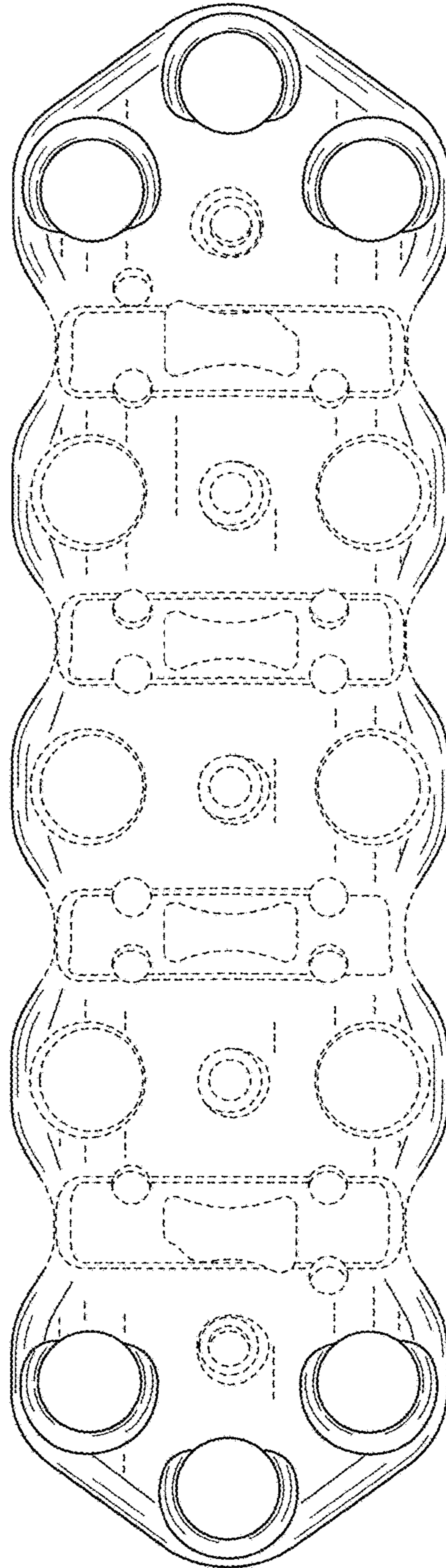

FIG. 15

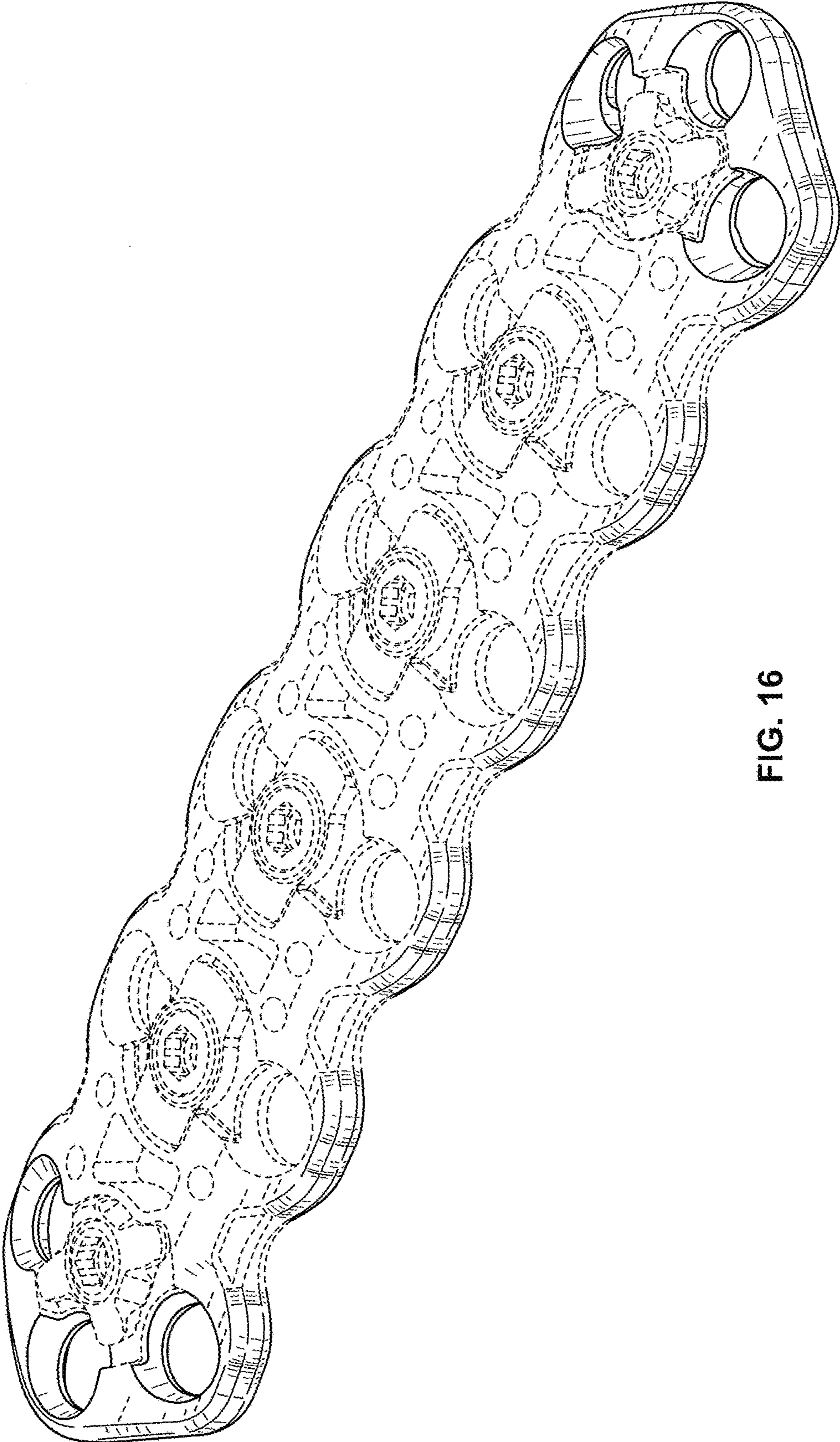

FIG. 16

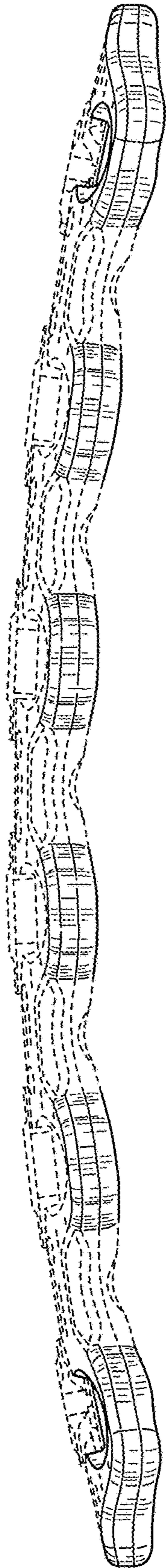

FIG. 17

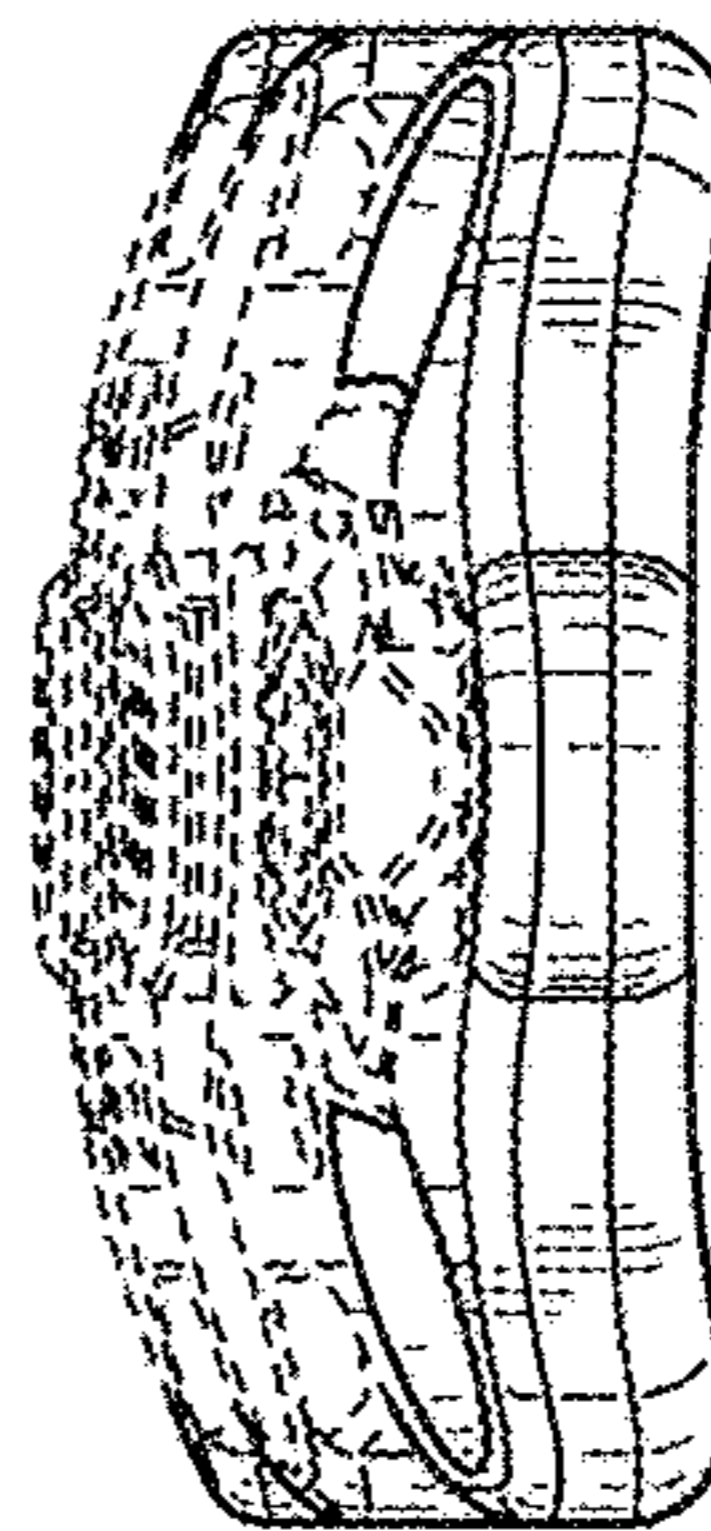

FIG. 18

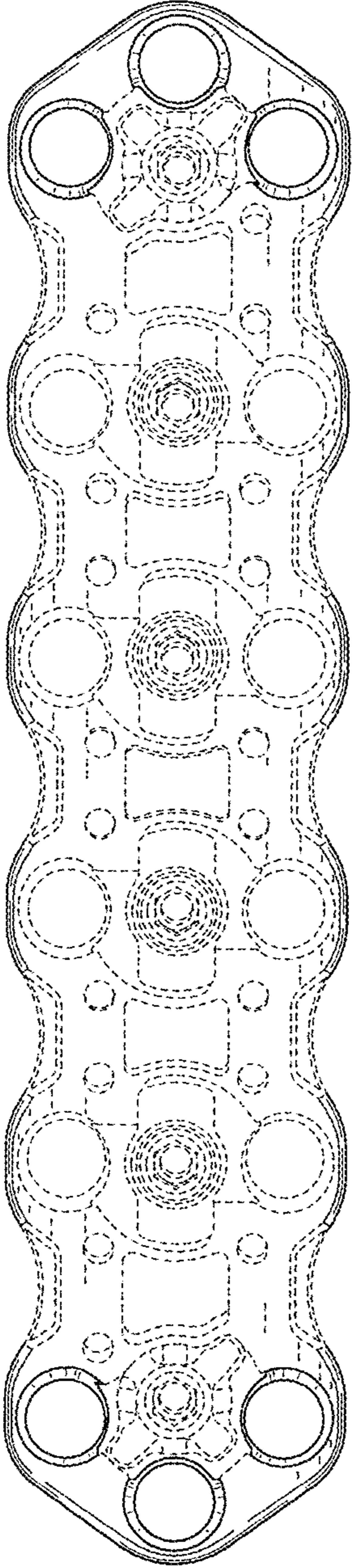

FIG. 19

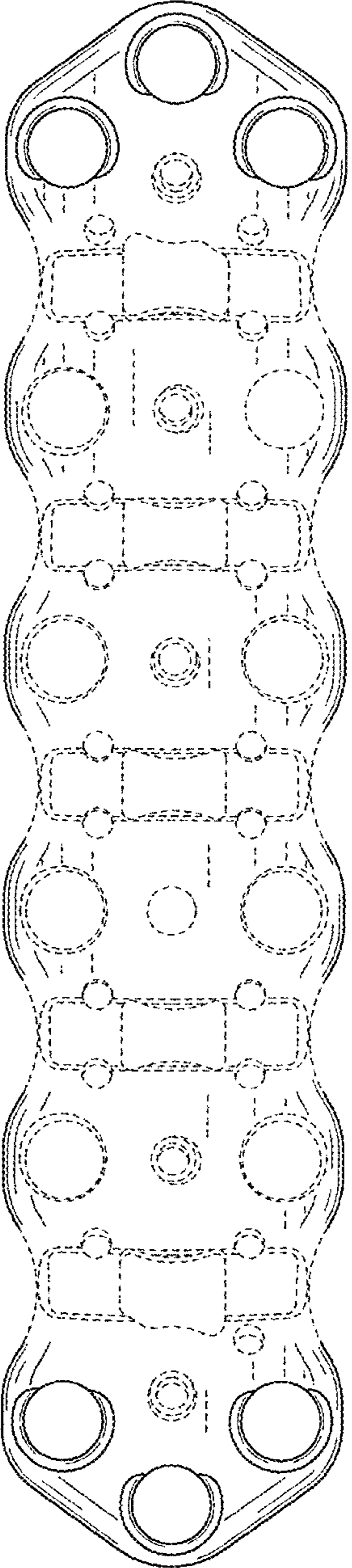

FIG. 20