



US00D798451S

(12) **United States Design Patent** (10) **Patent No.:** **US D798,451 S**  
**Shotton et al.** (45) **Date of Patent:** **\*\* \*Sep. 26, 2017**

(54) **STOPPER FOR DENTAL INSTRUMENTS**

(74) *Attorney, Agent, or Firm* — David A. Zdurne;  
Douglas J. Hura; Leana Levin

(71) Applicant: **DENTSPLY International Inc.**, York,  
PA (US)

(57) **CLAIM**

(72) Inventors: **Vincent Shotton**, Broken Arrow, OK  
(US); **Kevin Wilkinson**, Bixby, OK  
(US)

The ornamental design for a stopper for dental instruments,  
as shown and described.

(73) Assignee: **DENTSPLY International Inc.**, York,  
PA (US)

**DESCRIPTION**

(\*) Notice: This patent is subject to a terminal dis-  
claimer.

(\*\*) Term: **14 Years**

FIG. 1 is a top perspective view of the present invention for  
a stopper for dental instruments, the bottom perspective  
view being a mirror image;  
FIG. 2 is a side view of the stopper shown in FIG. 1, the  
opposite side view being a mirror image thereof;  
FIG. 3 is a top perspective view of a second embodiment of  
the present invention for a stopper for dental instruments, the  
bottom perspective view being a mirror image;  
FIG. 4 is a side view of the stopper shown in FIG. 3, the  
opposite side view being a mirror image thereof;  
FIG. 5 is a top perspective view of a third embodiment of the  
present invention for a stopper for dental instruments, the  
bottom perspective view being a mirror image;  
FIG. 6 is a side view of the stopper shown in FIG. 5, the  
opposite side view being a mirror image thereof;  
FIG. 7 is a top perspective view of a fourth embodiment of  
the present invention for a stopper for dental instruments, the  
bottom perspective view being a mirror image;  
FIG. 8 is a side view of the stopper shown in FIG. 7, the  
opposite side view being a mirror image thereof;  
FIG. 9 is a top perspective view of a fifth embodiment of the  
present invention for a stopper for dental instruments, the  
bottom perspective view being a mirror image;  
FIG. 10 is a side view of the stopper shown in FIG. 9, the  
opposite side view being a mirror image thereof;  
FIG. 11 is a top perspective view of a sixth embodiment of  
the present invention for a stopper for dental instruments, the  
bottom perspective view being a mirror image;  
FIG. 12 is a side view of the stopper shown in FIG. 11, the  
opposite side view being a mirror image thereof;  
FIG. 13 is a top perspective view of a seventh embodiment  
of the present invention for a stopper for dental instruments,  
the bottom perspective view being a mirror image;

(21) Appl. No.: **29/519,321**

(22) Filed: **Mar. 4, 2015**

**Related U.S. Application Data**

(62) Division of application No. 29/453,764, filed on May  
2, 2013, now Pat. No. Des. 744,102.

(51) **LOC (10) Cl.** ..... **24-02**

(52) **U.S. Cl.**  
USPC ..... **D24/152**

(58) **Field of Classification Search**  
USPC ..... D24/152, 127, 128, 133; D8/300, 310,  
D8/312, 321, 330, 331, 335, 343, 352,  
(Continued)

(56) **References Cited**

**U.S. PATENT DOCUMENTS**

D308,725 S \* 6/1990 Kraus ..... D24/128  
D437,411 S \* 2/2001 Maeji ..... D24/127  
(Continued)

*Primary Examiner* — Wan Laymon  
*Assistant Examiner* — Mark Booker

(Continued)

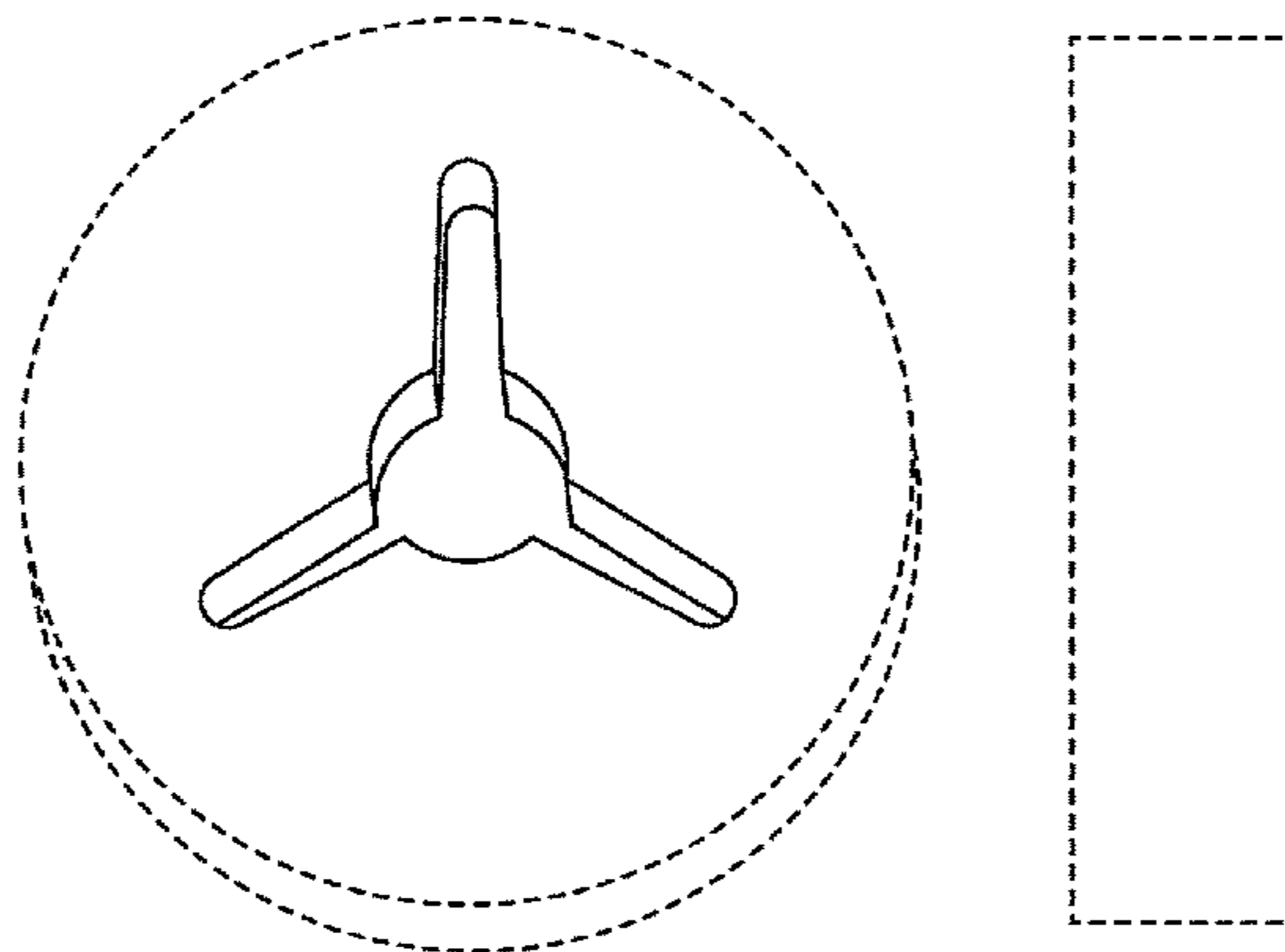

FIG. 26 is a side view of the stopper shown in FIG. 25, the opposite side view being a mirror image thereof;  
 FIG. 15 is a top perspective view of an eighth embodiment of the present invention for a stopper for dental instruments, the bottom perspective view being a mirror image;  
 FIG. 16 is a side view of the stopper shown in FIG. 15, the opposite side view being a mirror image thereof;  
 FIG. 17 is a top perspective view of a ninth embodiment of the present invention for a stopper for dental instruments, the bottom perspective view being a mirror image;  
 FIG. 18 is a side view of the stopper shown in FIG. 17, the opposite side view being a mirror image thereof;  
 FIG. 19 is a top perspective view of a tenth embodiment of the present invention for a stopper for dental instruments, the bottom perspective view being a mirror image;  
 FIG. 20 is a side view of the stopper shown in FIG. 19, the opposite side view being a mirror image thereof;  
 FIG. 21 is a top perspective view of an eleventh embodiment of the present invention for a stopper for dental instruments, the bottom perspective view being a mirror image;  
 FIG. 22 is a side view of the stopper shown in FIG. 21, the opposite side view being a mirror image thereof;  
 FIG. 23 is a top perspective view of a twelfth embodiment of the present invention for a stopper for dental instruments, the bottom perspective view being a mirror image;  
 FIG. 24 is a side view of the stopper shown in FIG. 23, the opposite side view being a mirror image thereof;  
 FIG. 25 is a perspective view of the present invention for a dental assembly comprising the stopper for dental instruments shown in FIG. 7; and,

FIG. 26 is a perspective view of the present invention for a dental assembly comprising the stopper for dental instruments shown in FIG. 7.

The broken lines immediately adjacent the claimed areas represent the bounds of the claim, and all other broken lines are included for the purpose of illustrating portions of the present invention that form no part of the claimed design. None of the broken lines form part of the claimed design.

**1 Claim, 7 Drawing Sheets**

(58) **Field of Classification Search**

USPC ..... D8/354, 382; 606/268, 269, 274, 265,  
 606/295, 270  
 CPC ..... A47K 1/14; A61C 8/0048; A61C 13/12;  
 A61C 13/225; A61C 5/025  
 See application file for complete search history.

(56) **References Cited**

U.S. PATENT DOCUMENTS

D437,412	S	*	2/2001	Maeji	.....	D24/127
D572,426	S	*	7/2008	McCollum	.....	D1/106
D597,205	S	*	7/2009	Koch	.....	D24/133
D621,249	S	*	8/2010	Heindl	.....	D8/382
8,609,124	B2	*	12/2013	Spagnoli	.....	A61B 17/666 424/423
D721,573	S	*	1/2015	Fievet	.....	D8/382
D744,102	S	*	11/2015	Shotton	.....	D24/152
2012/0191141	A1	*	7/2012	Costabile	.....	A61B 17/8042 606/295

\* cited by examiner

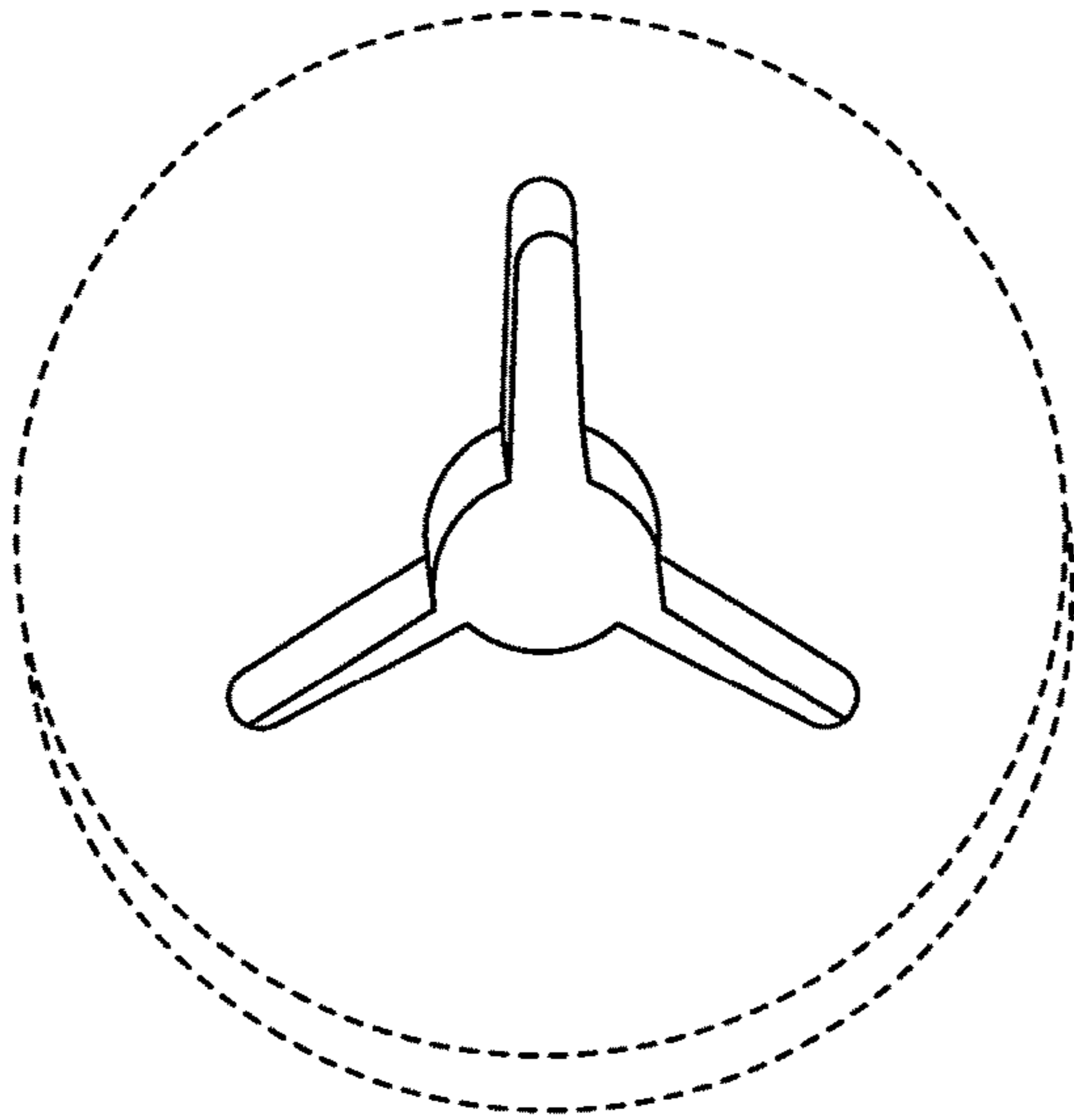

FIG. 1

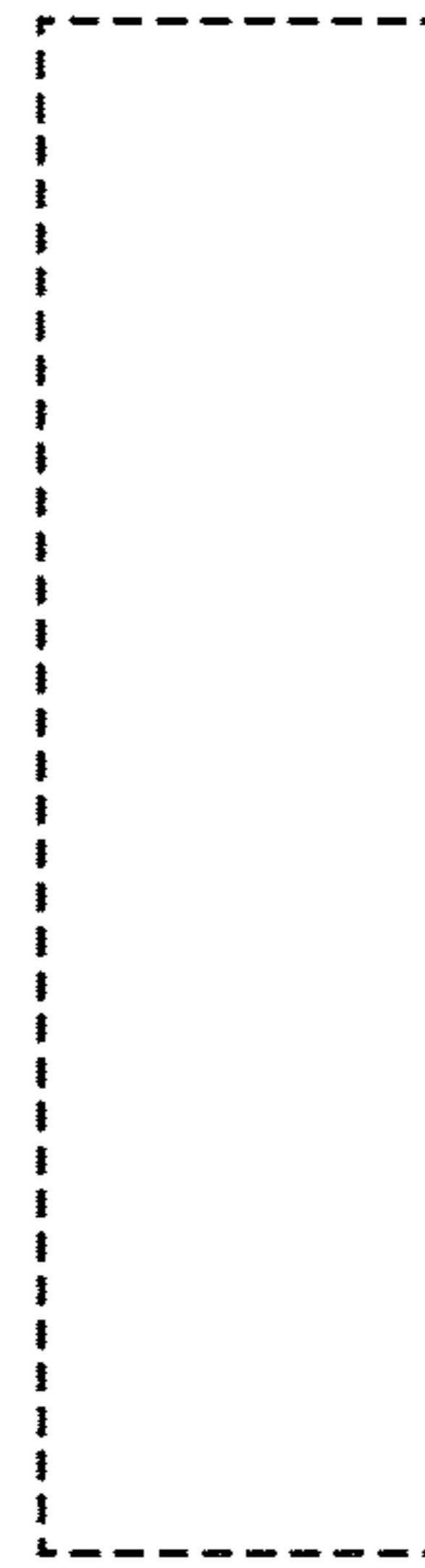

FIG. 2

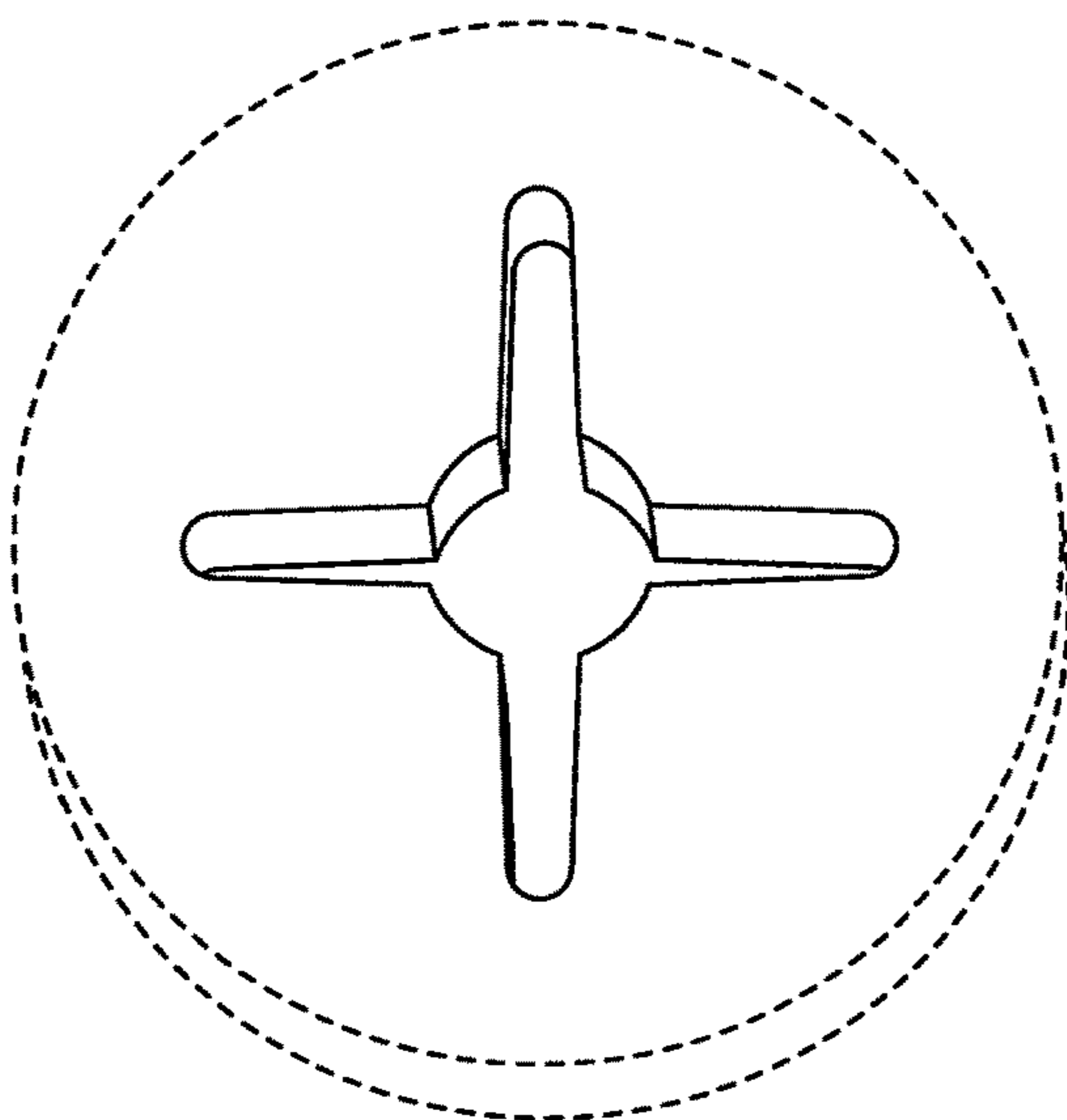

FIG. 3

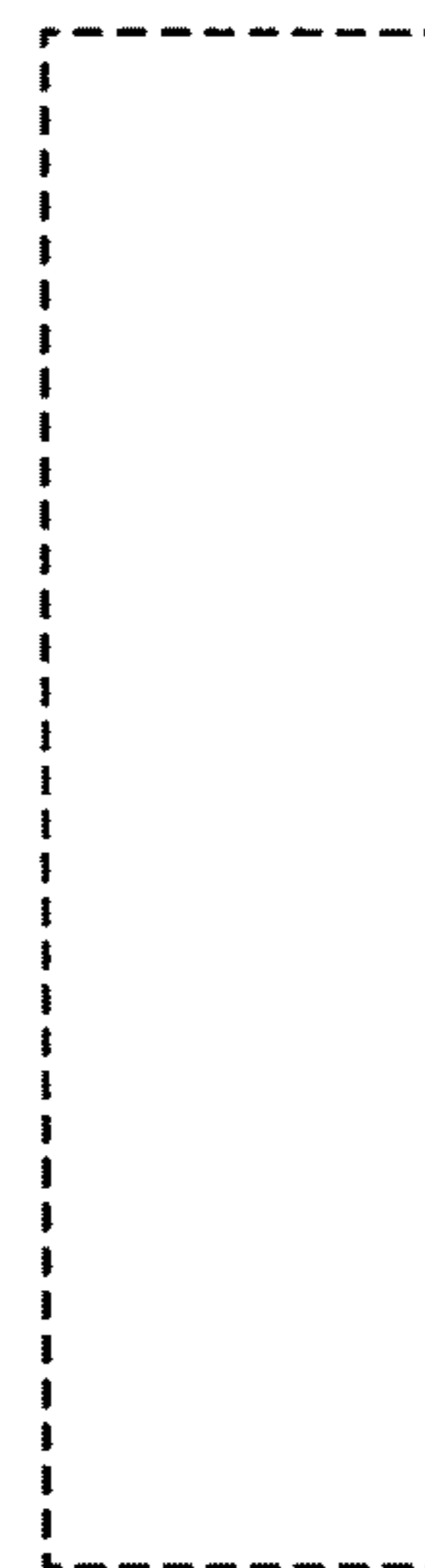

FIG. 4

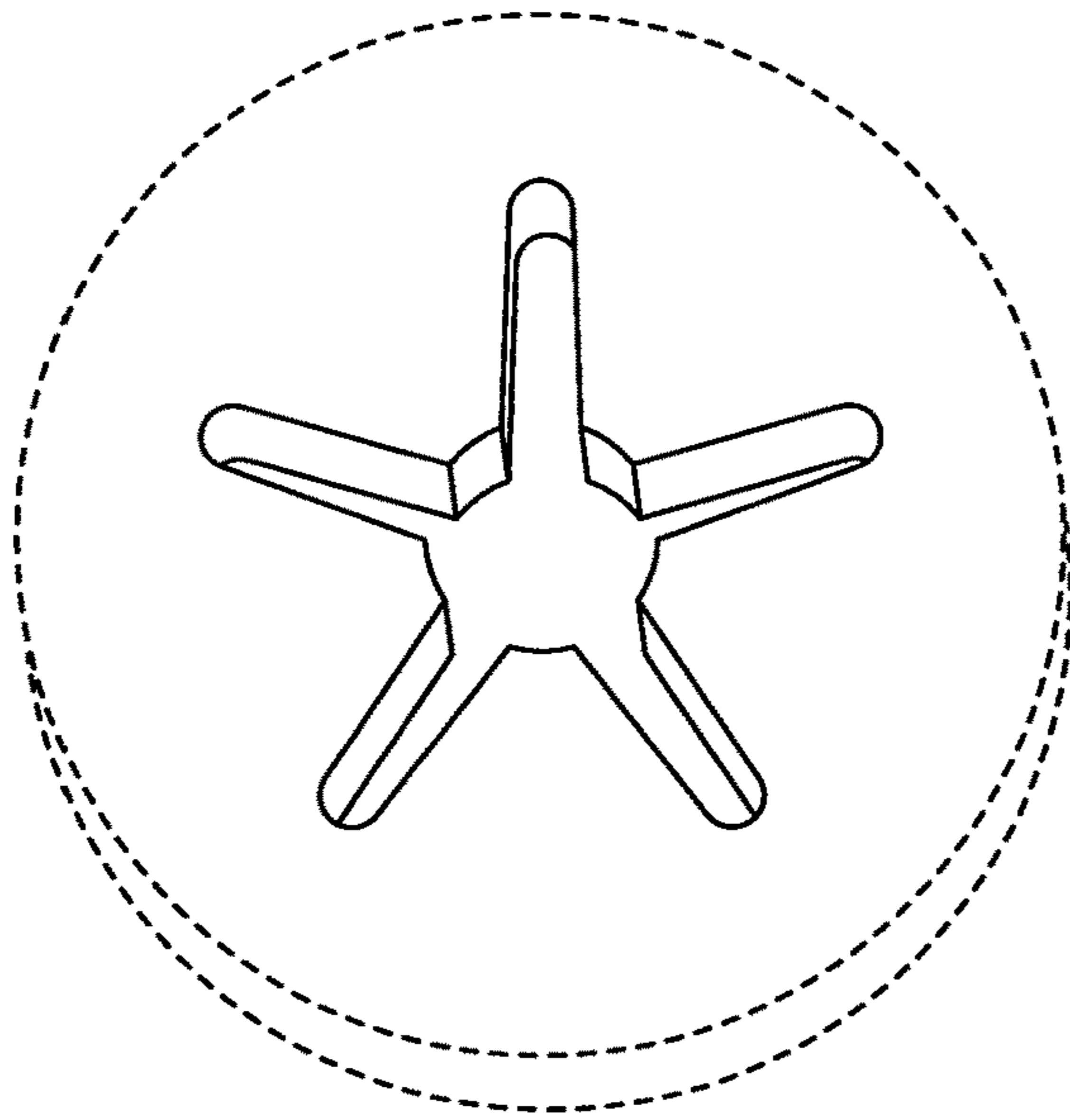

FIG. 5

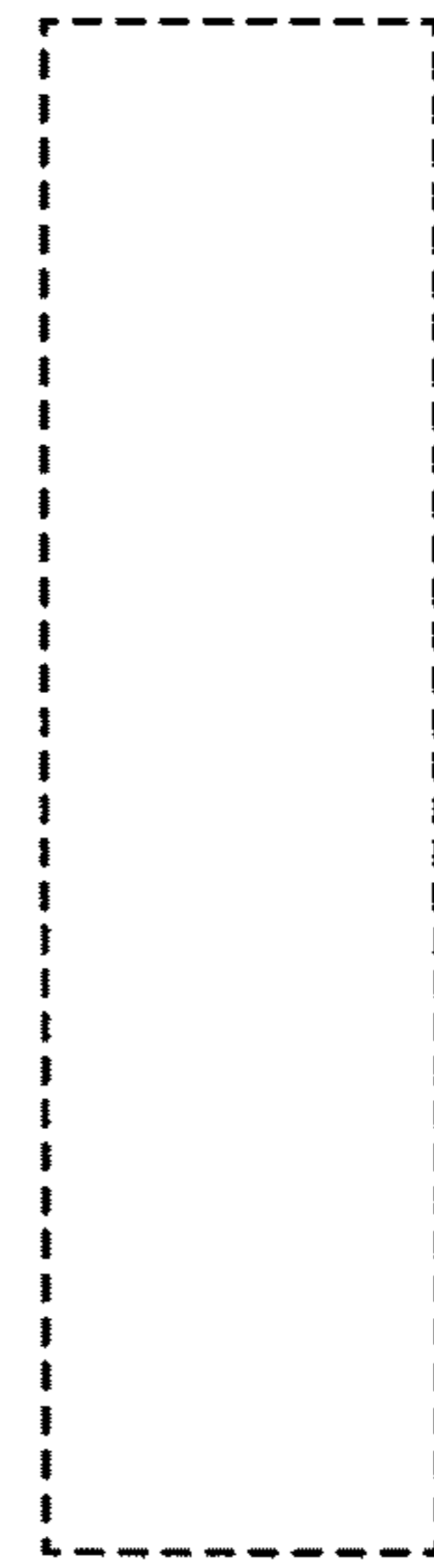

FIG. 6

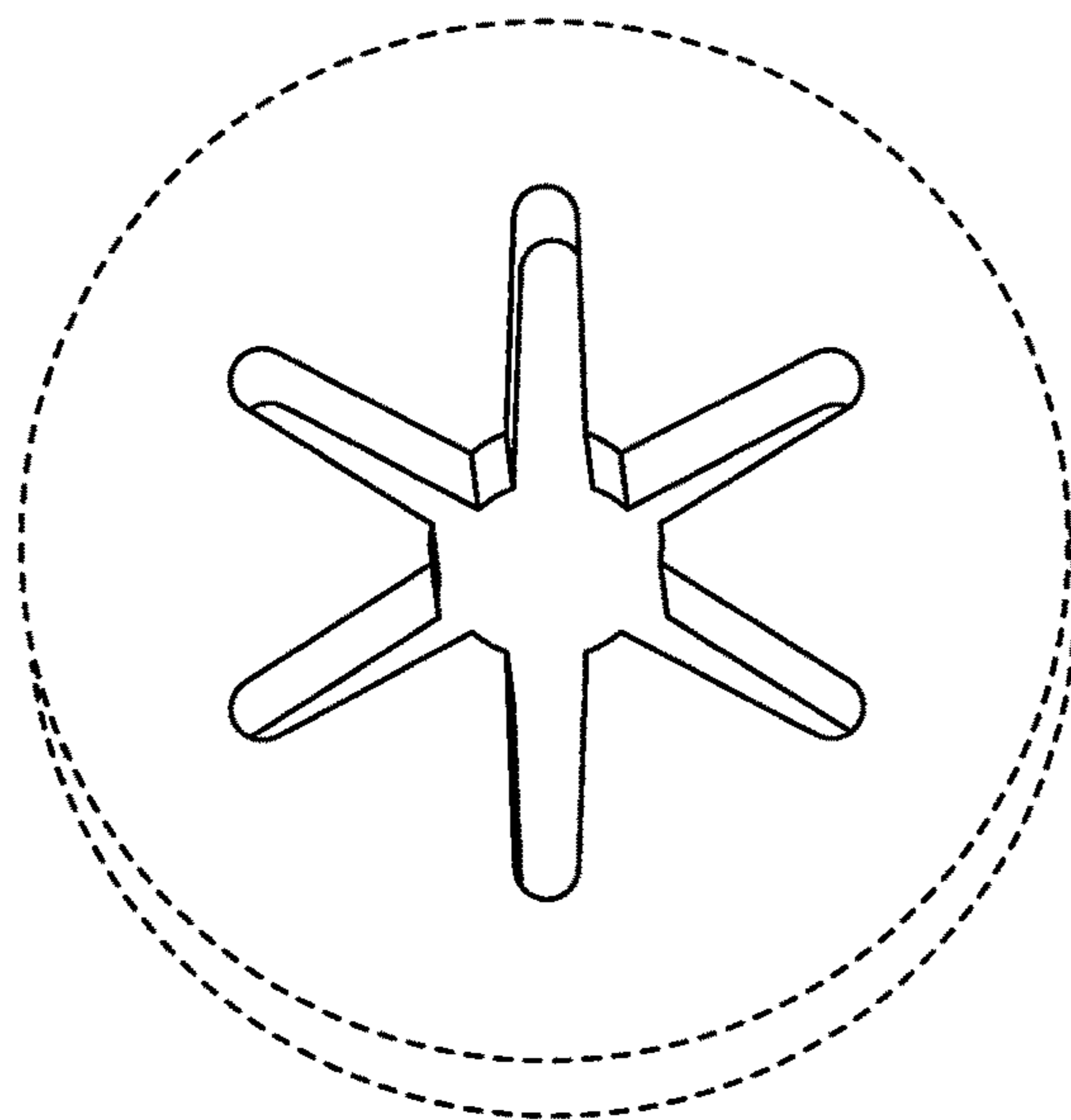

FIG. 7

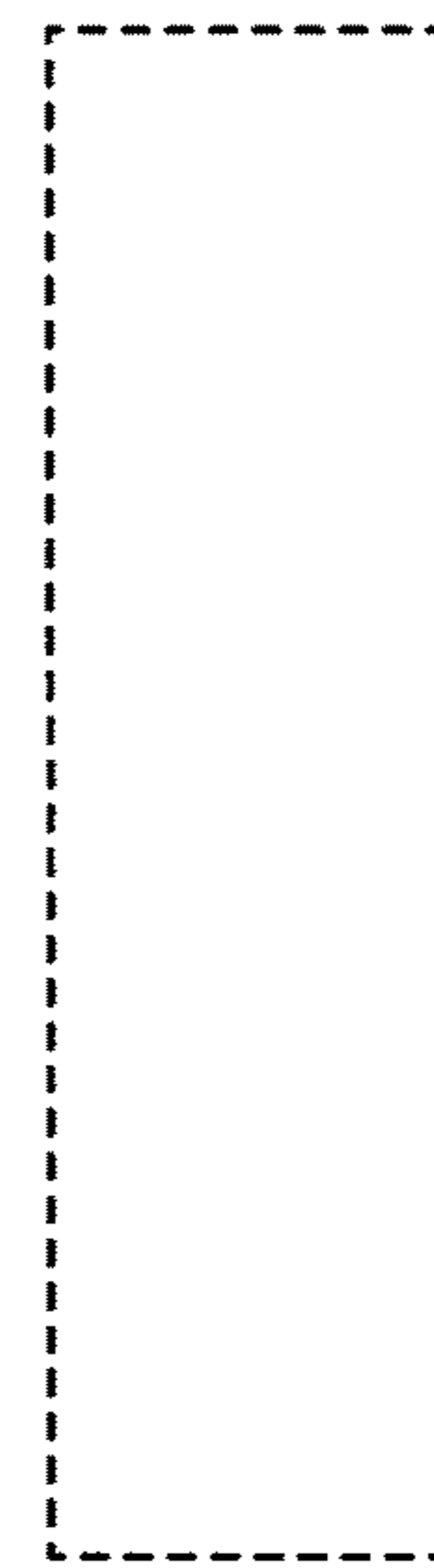

FIG. 8

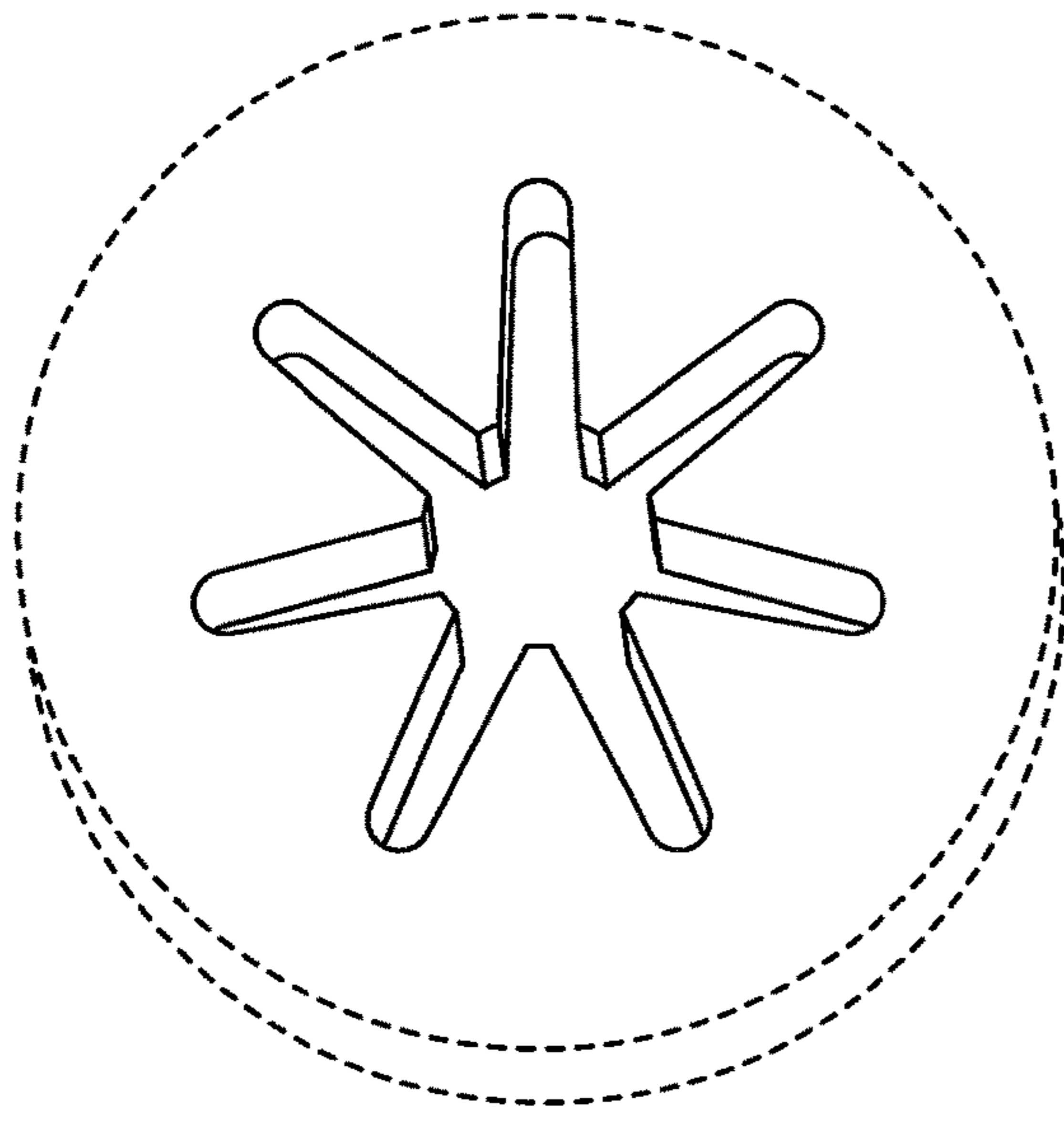

FIG. 9

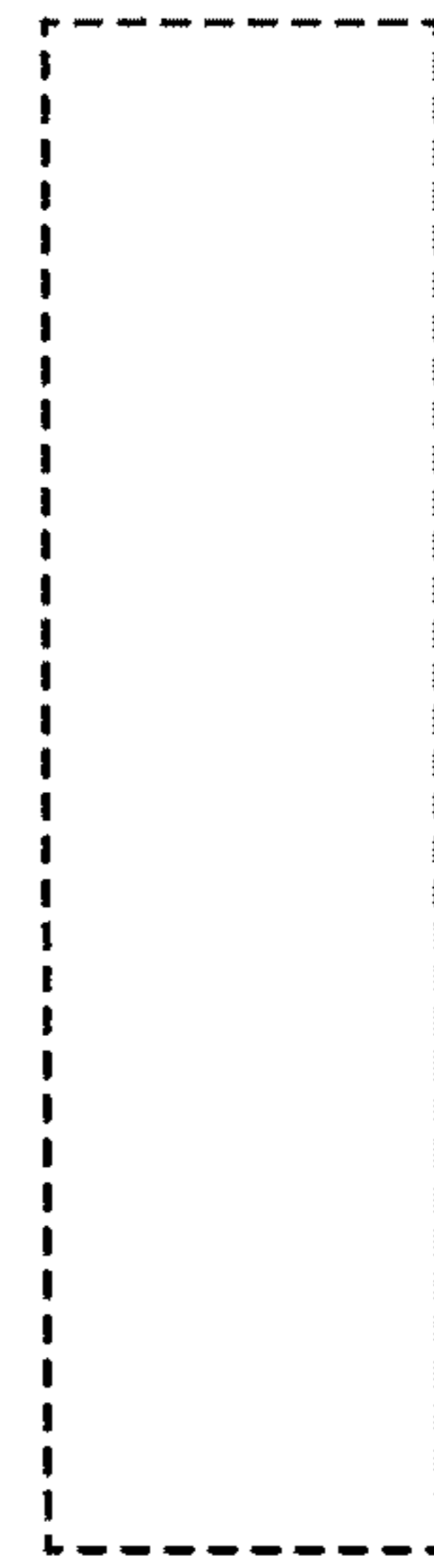

FIG. 10

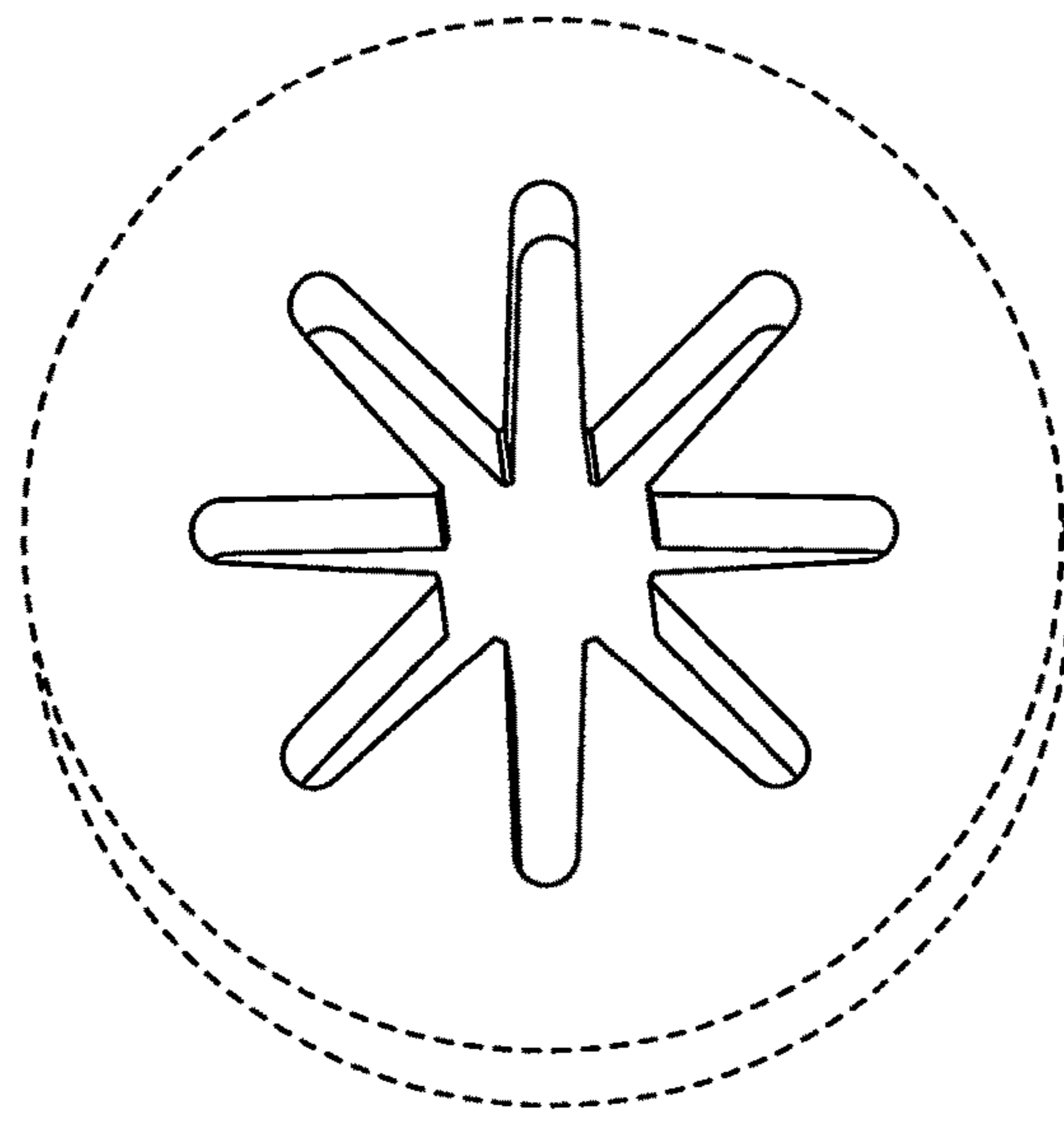

FIG. 11

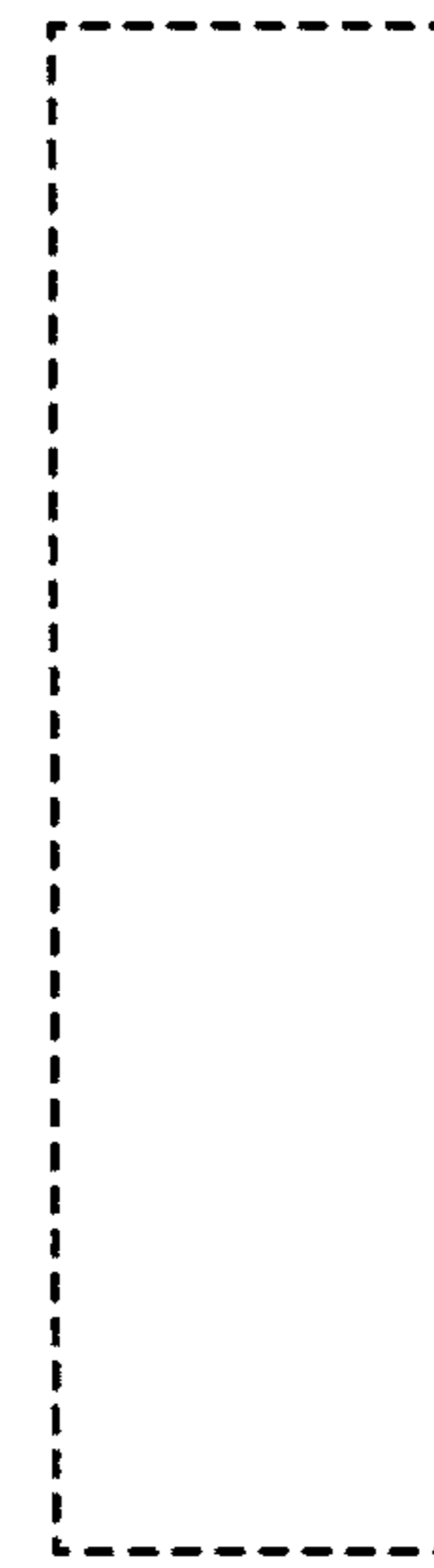

FIG. 12

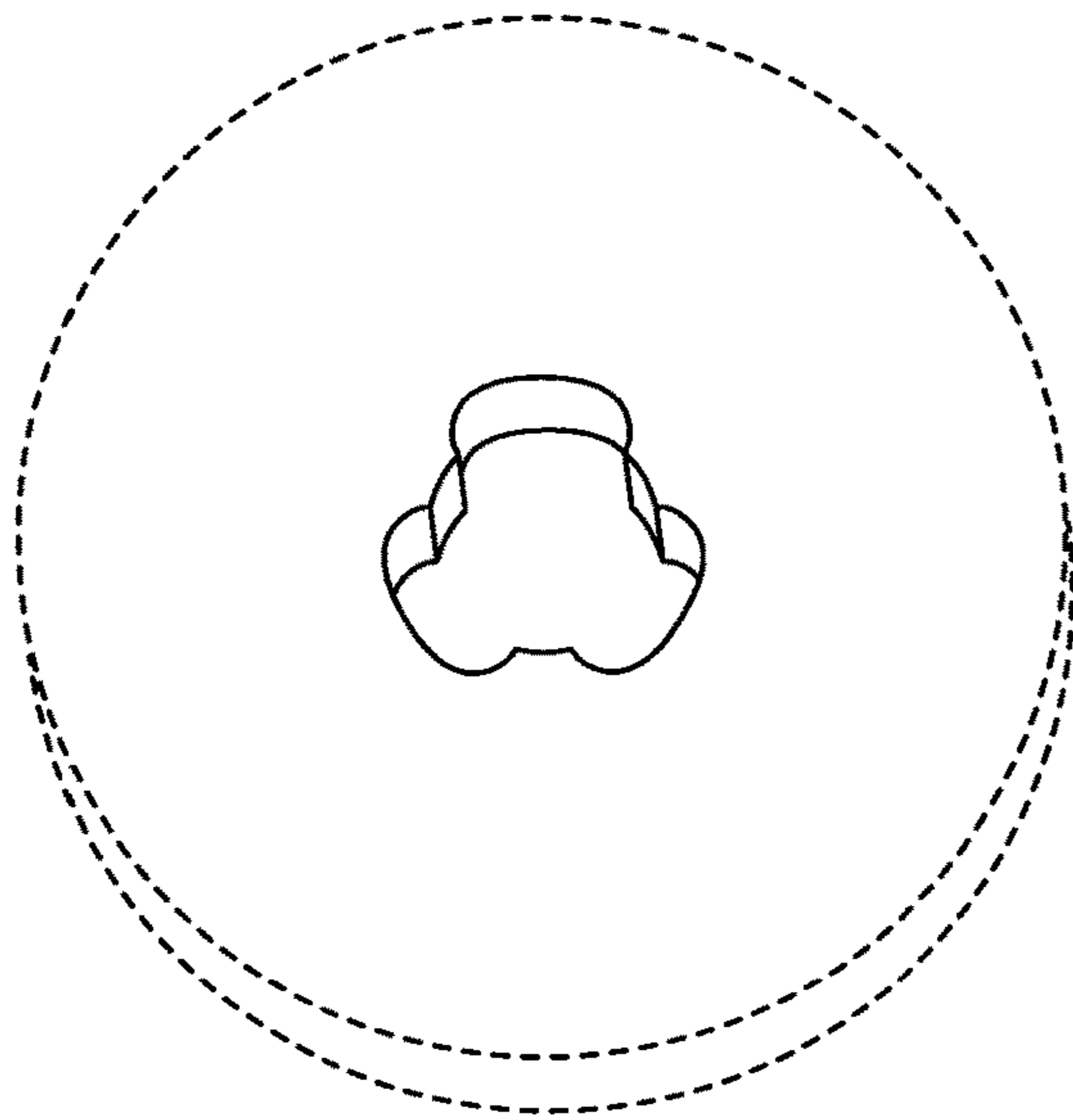

FIG. 13

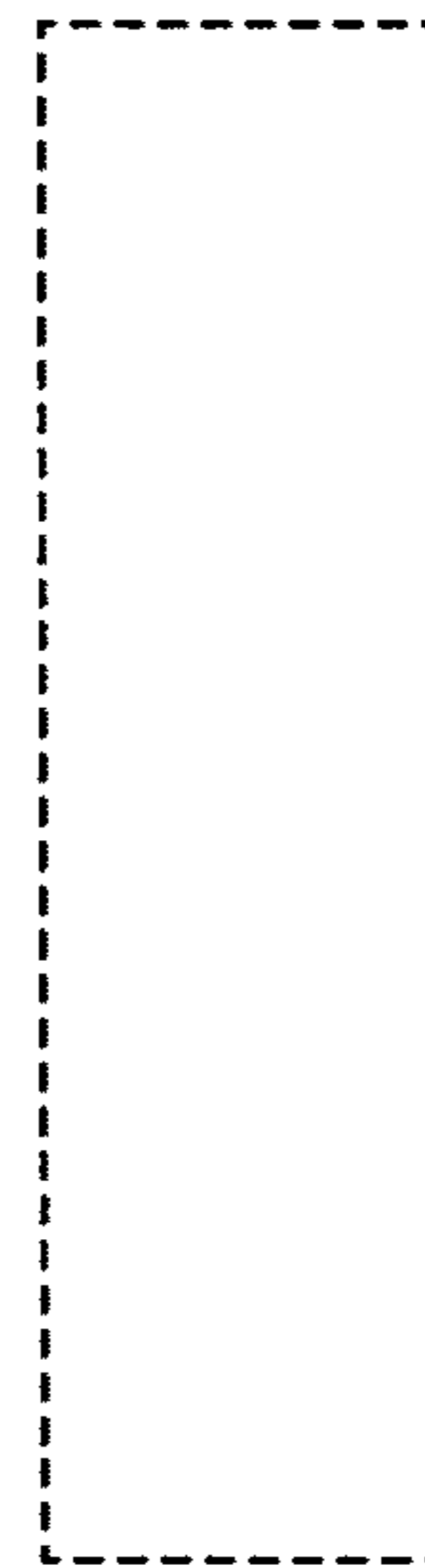

FIG. 14

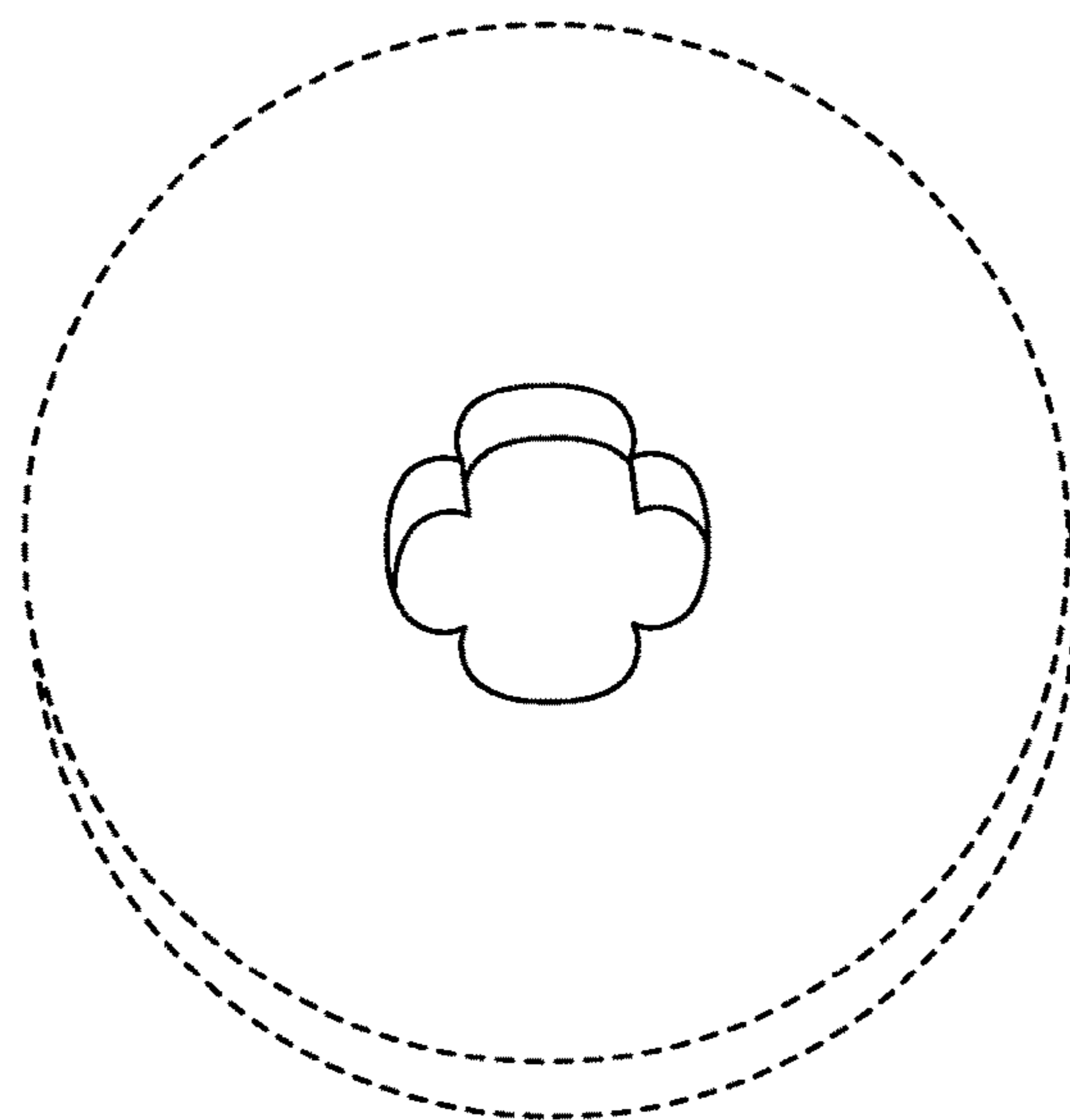

FIG. 15

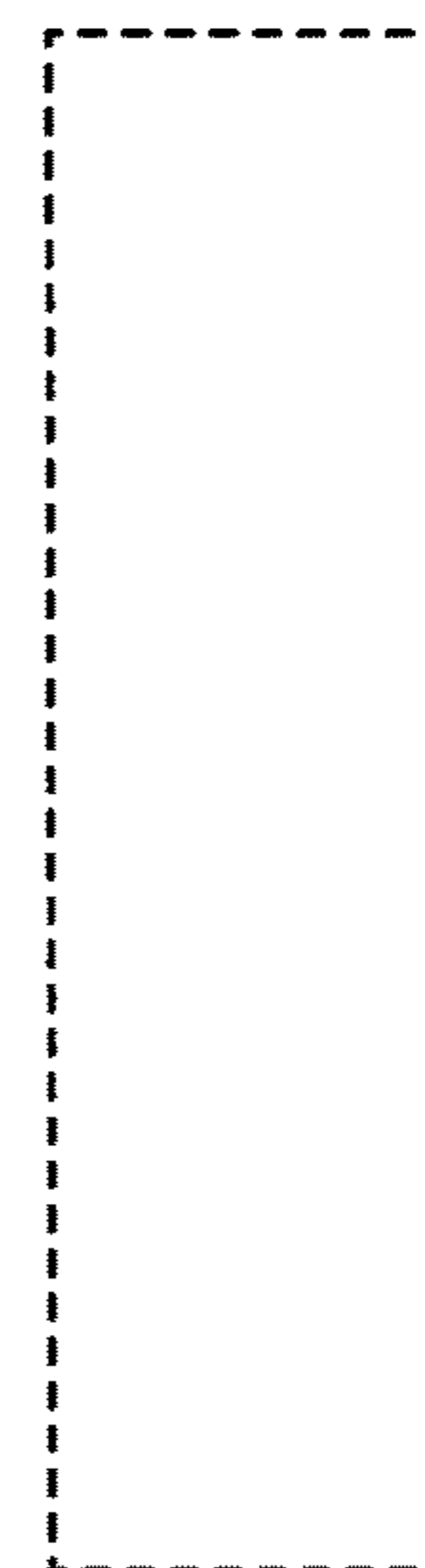

FIG. 16

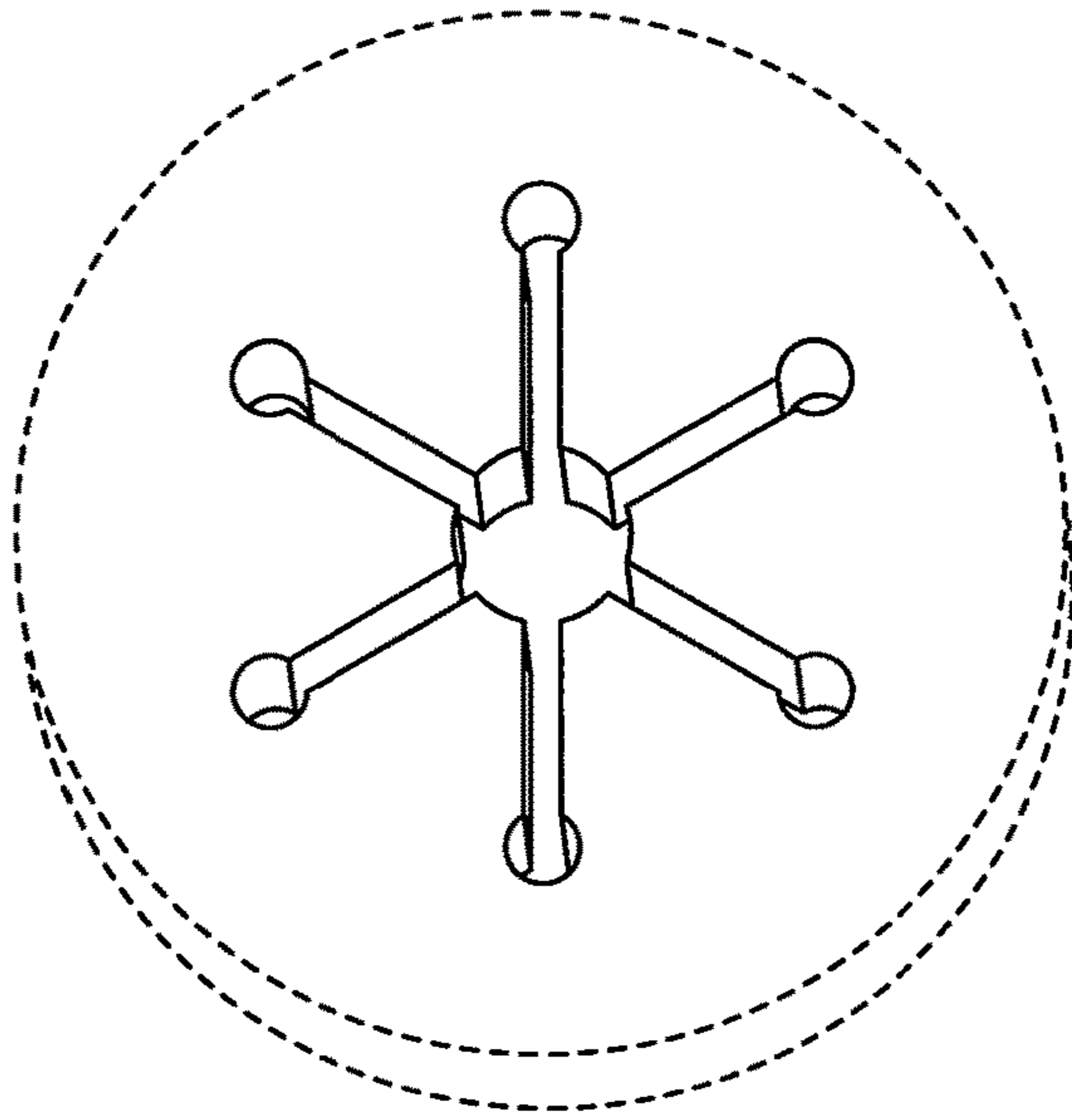

FIG. 17

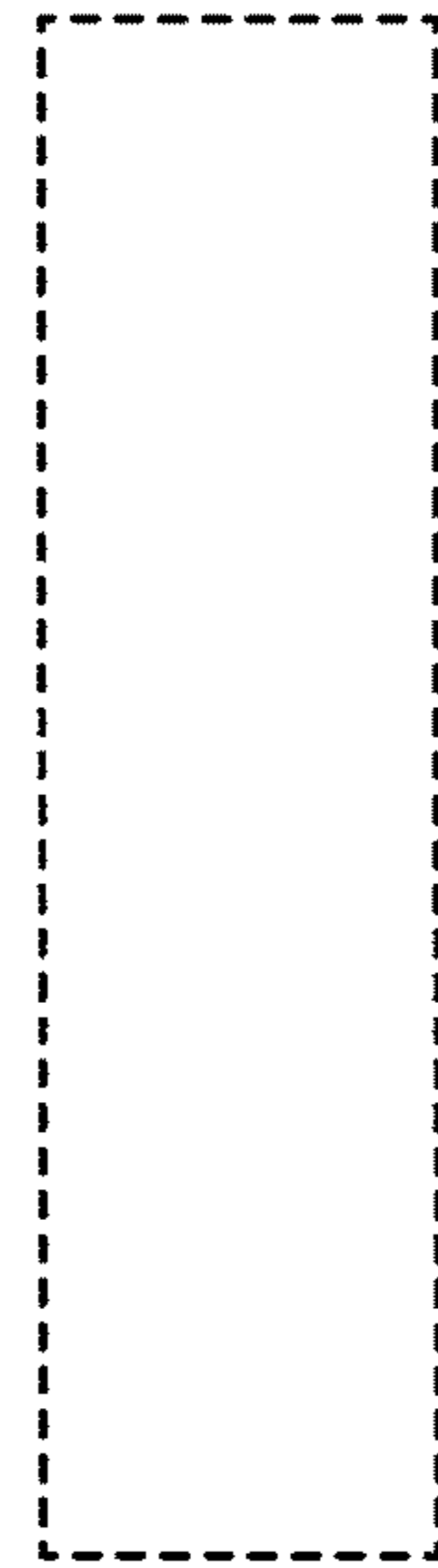

FIG. 18

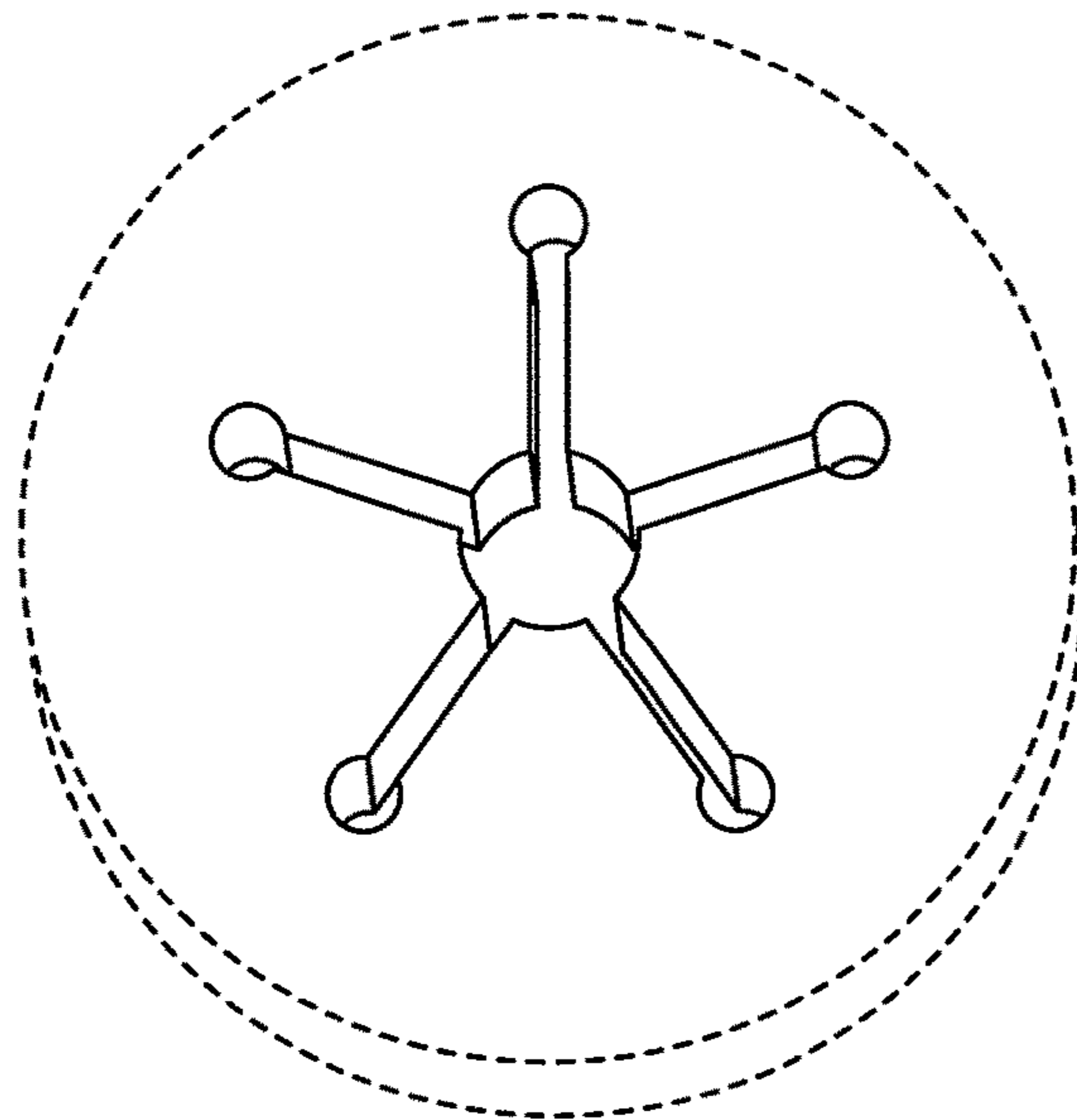

FIG. 19

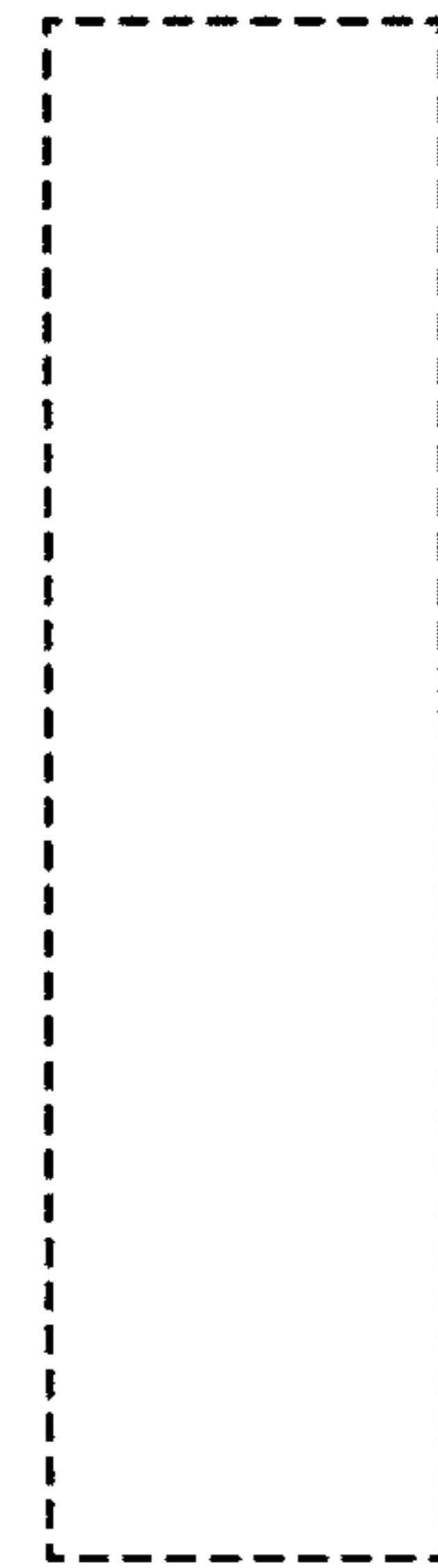

FIG. 20

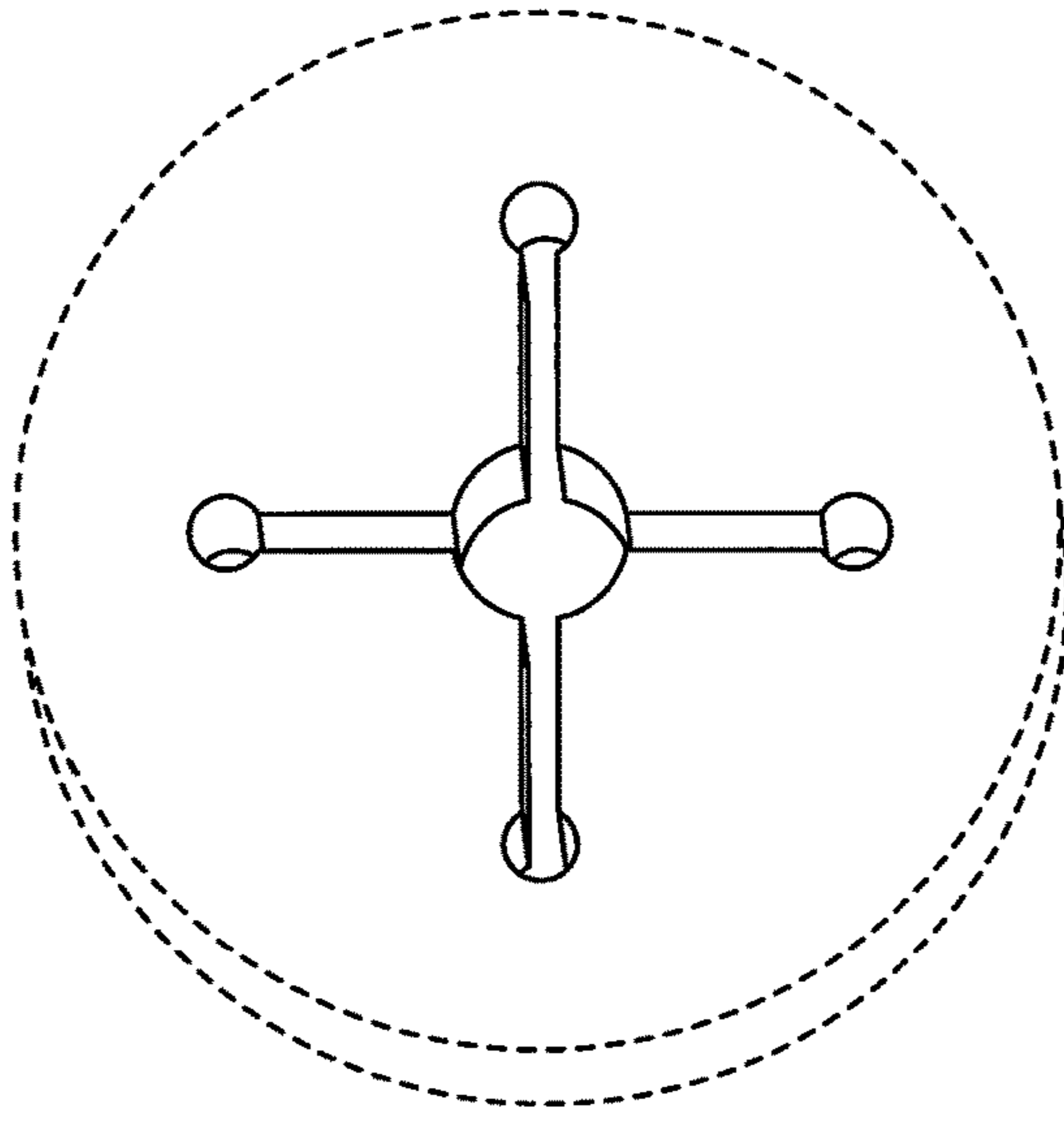

FIG. 21

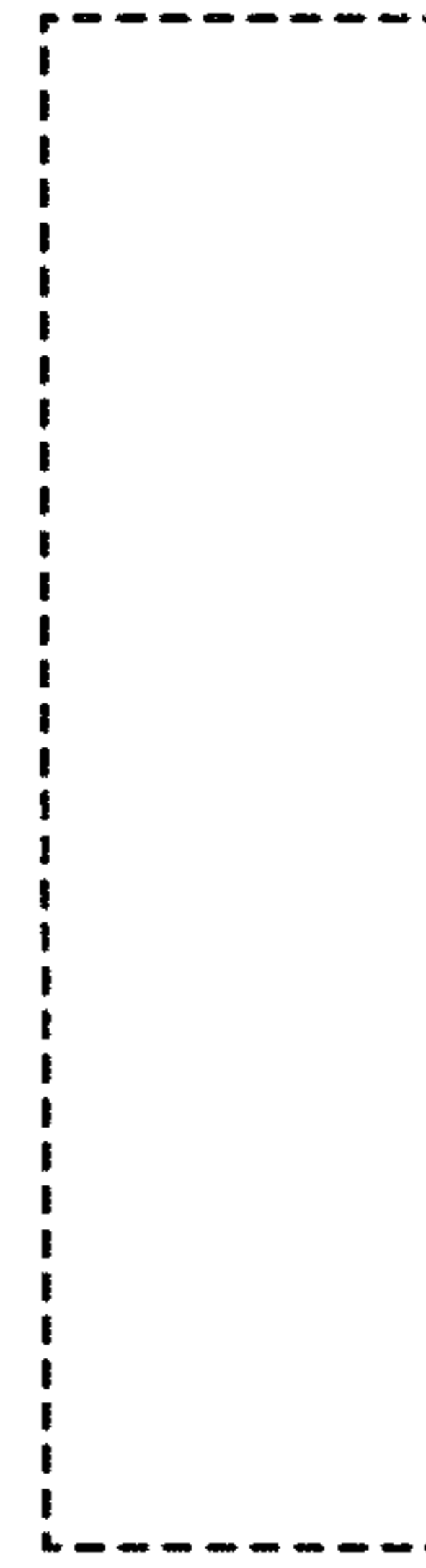

FIG. 22

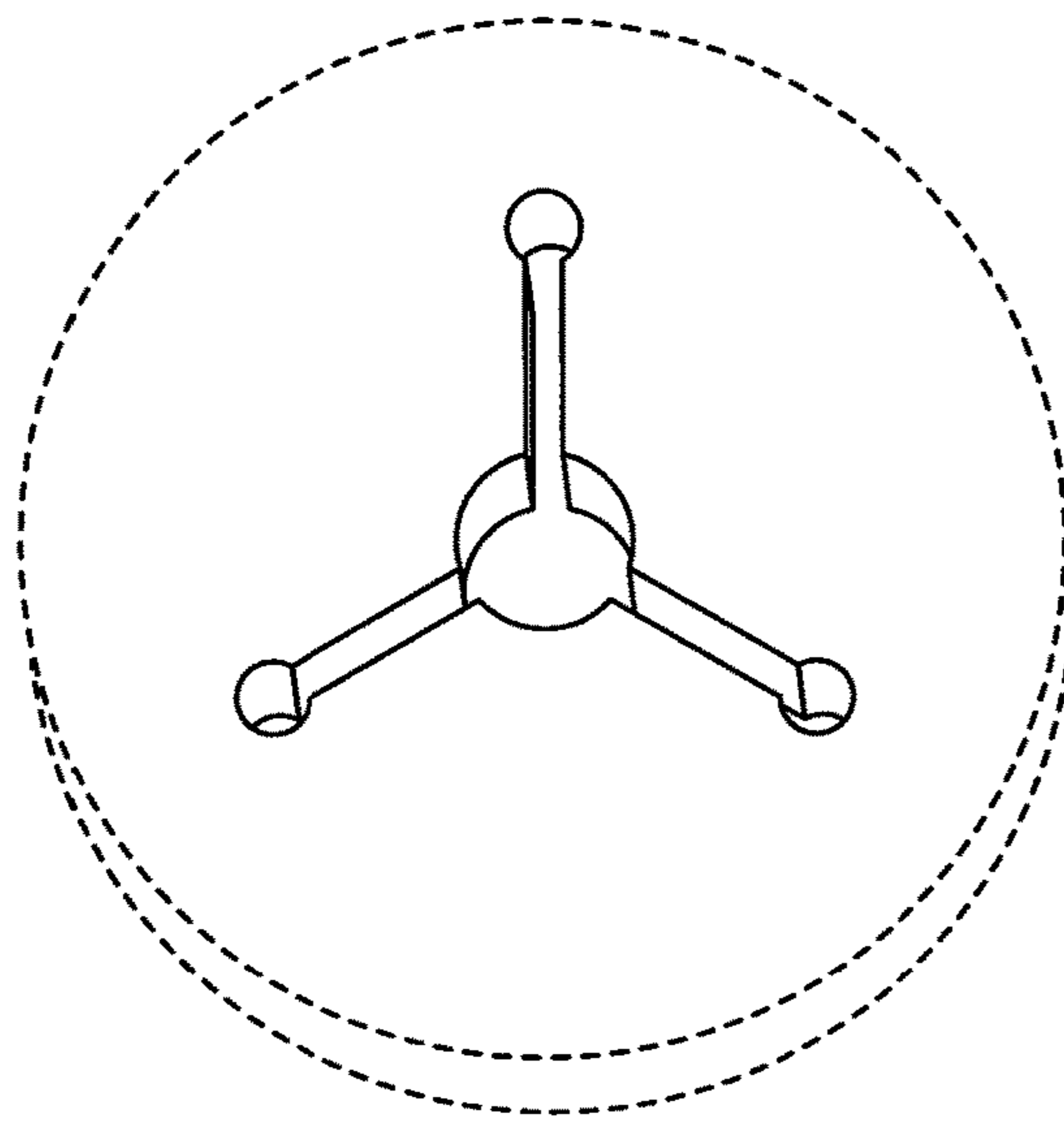

FIG. 23

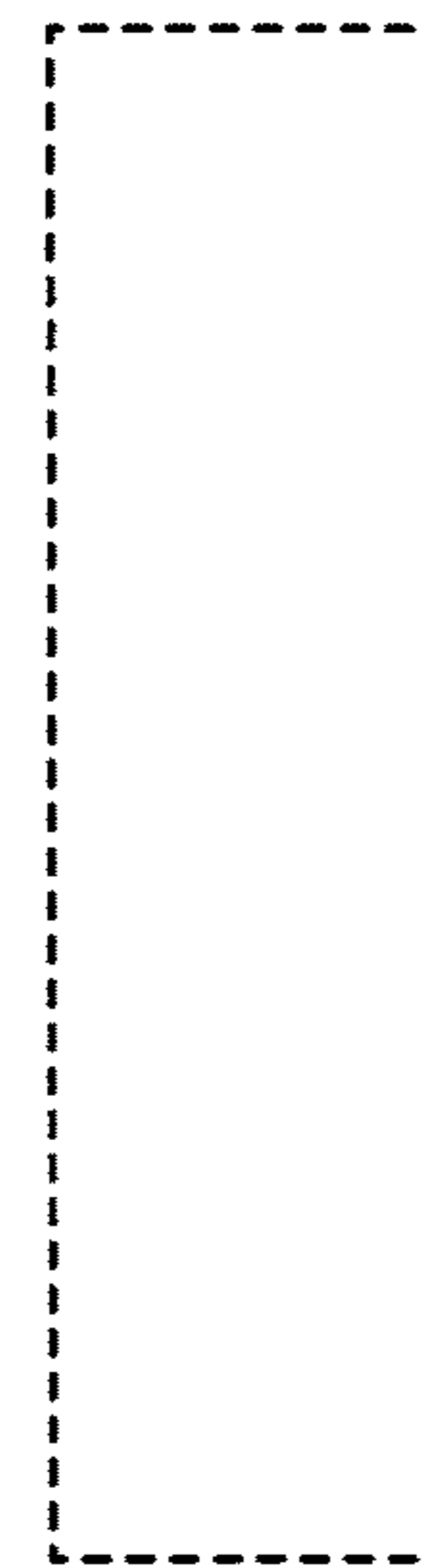

FIG. 24



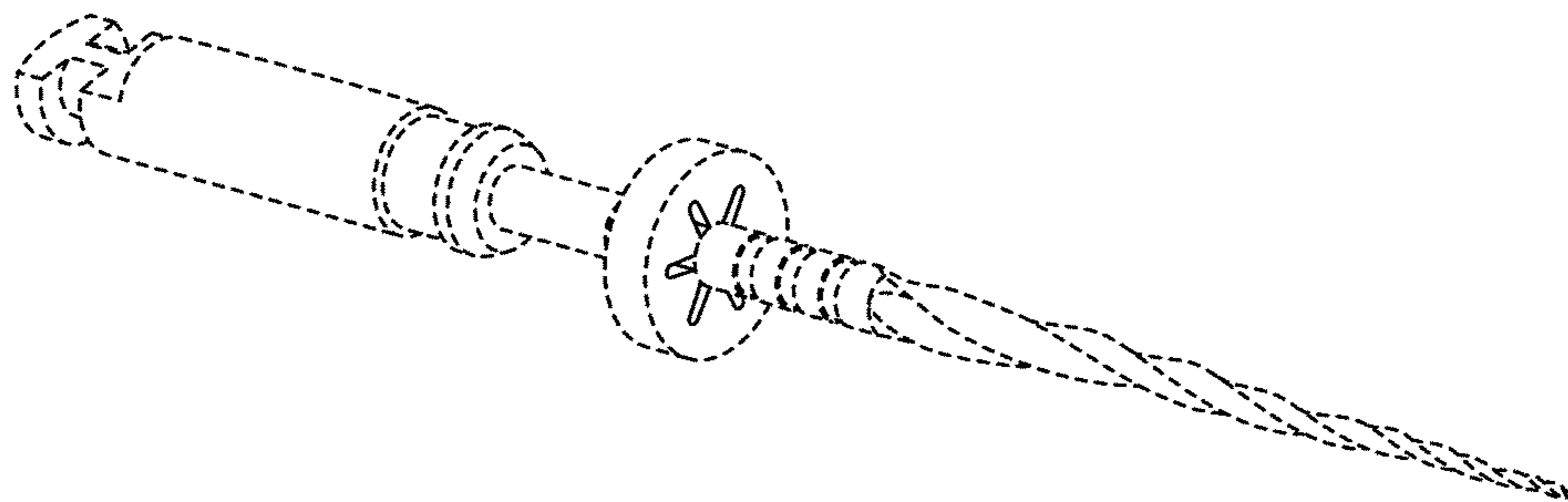

FIG. 25

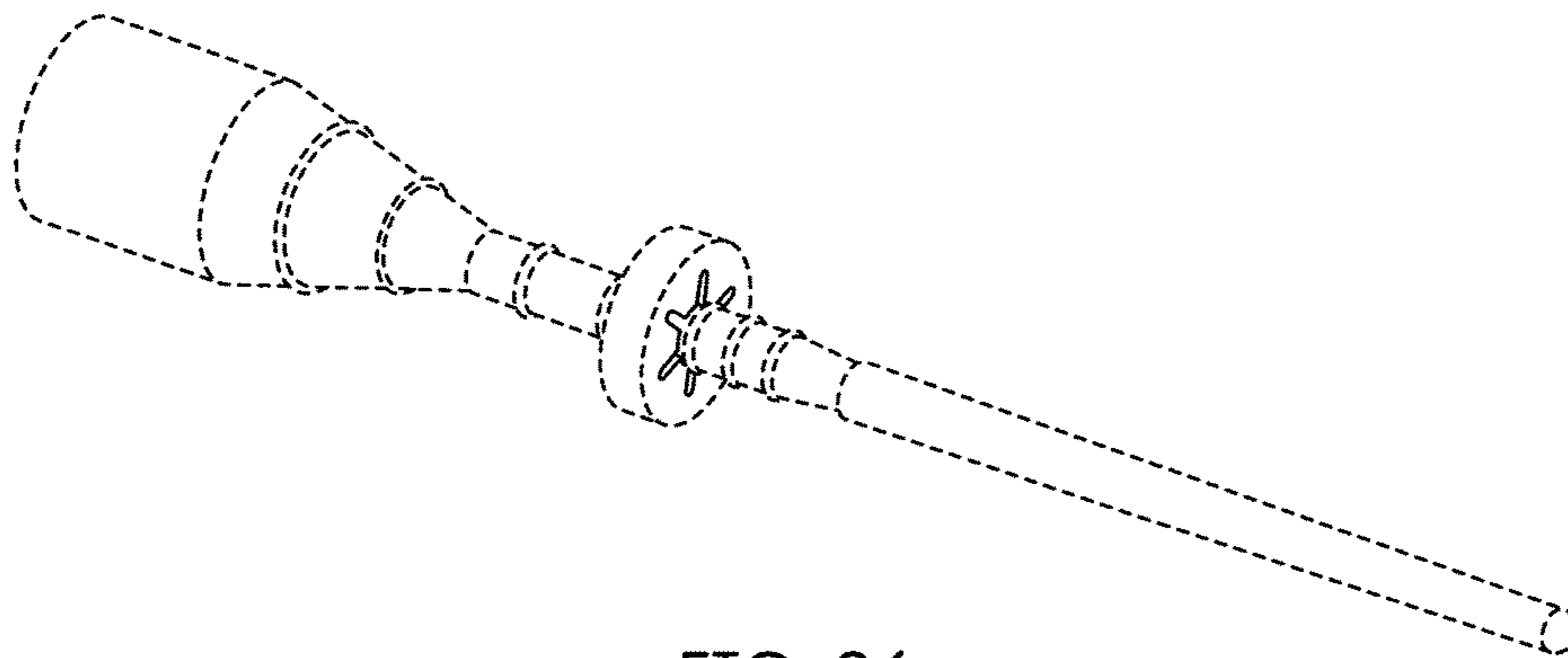

FIG. 26