



US00D798118S

(12) **United States Design Patent** (10) **Patent No.:** **US D798,118 S**
Karagkouni et al. (45) **Date of Patent:** **** Sep. 26, 2017**

(54) **MILK COOLER**

CPC .. A47G 19/2288; A47G 19/127; A47G 19/12;
A47G 19/22

(71) Applicant: **KONINKLIJKE PHILIPS N.V.**,
Eindhoven (NL)

See application file for complete search history.

(72) Inventors: **Aikaterini Karagkouni**, Eindhoven
(NL); **Doortje Van De Wouw**,
Eindhoven (NL); **Maarten Marinus**
Johannes Wilhelmus Van Herpen,
Eindhoven (NL)

(56) **References Cited**

U.S. PATENT DOCUMENTS

(73) Assignee: **KONINKLIJKE PHILIPS N.V.**,
Eindhoven (NL)

D254,180 S *	2/1980	Morin	D7/612
D256,651 S *	9/1980	Leung	D7/608
D261,088 S *	10/1981	Akimov	D7/608
D279,346 S *	6/1985	Ruxton	D7/321
D286,847 S *	11/1986	Zimmermann	D7/608
D372,172 S *	7/1996	Morales Segura	D7/608
D414,659 S *	10/1999	Hunt	D7/608
D453,448 S *	2/2002	Segura	D7/608
D479,951 S *	9/2003	Segura	D7/608
D494,424 S *	8/2004	Segura	D7/608
D540,626 S *	4/2007	Janky	D7/608
D622,554 S *	8/2010	Carreno	D7/629
D628,857 S *	12/2010	Tatsukawa	D7/608
D643,694 S *	8/2011	Lu	D7/629
D653,086 S *	1/2012	Morales	D7/608
D660,657 S *	5/2012	Picozza	D7/629
D679,956 S *	4/2013	Zemel	D7/601

(**) Term: **15 Years**

(21) Appl. No.: **35/501,034**

(22) Filed: **Dec. 24, 2015**

(Continued)

(80) **Hague Agreement Data**

Int. Filing Date: **Dec. 24, 2015**

Int. Reg. No.: **DM/090733**

Int. Reg. Date: **Dec. 24, 2015**

Int. Reg. Pub. Date: **Jun. 3, 2016**

Primary Examiner — Sheryl Lane

Assistant Examiner — Nicole Shiflet

(57) **CLAIM**

The ornamental design for a milk cooler, as shown and described.

DESCRIPTION

(30) **Foreign Application Priority Data**

Jun. 28, 2015 (EM) 002727370-0001

Jun. 28, 2015 (EM) 002727370-0002

(51) **LOC (10) Cl.** **07-07**

(52) **U.S. Cl.**
USPC **D7/608**

(58) **Field of Classification Search**
USPC D7/608, 601, 602, 605, 619.1, 709, 629,
D7/630, 300, 612, 321; D9/738, 744

- 1.-2. Milk cooler
- 1.1 : Perspective
- 1.2 : Left Side
- 1.3 : Rear
- 1.4 : Right Side
- 1.5 : Front
- 1.6 : Top
- 1.7 : Bottom
- 2.1 : Right Side
- 2.2 : Rear
- 2.3 : Front
- 2.4 : Left Side

(Continued)

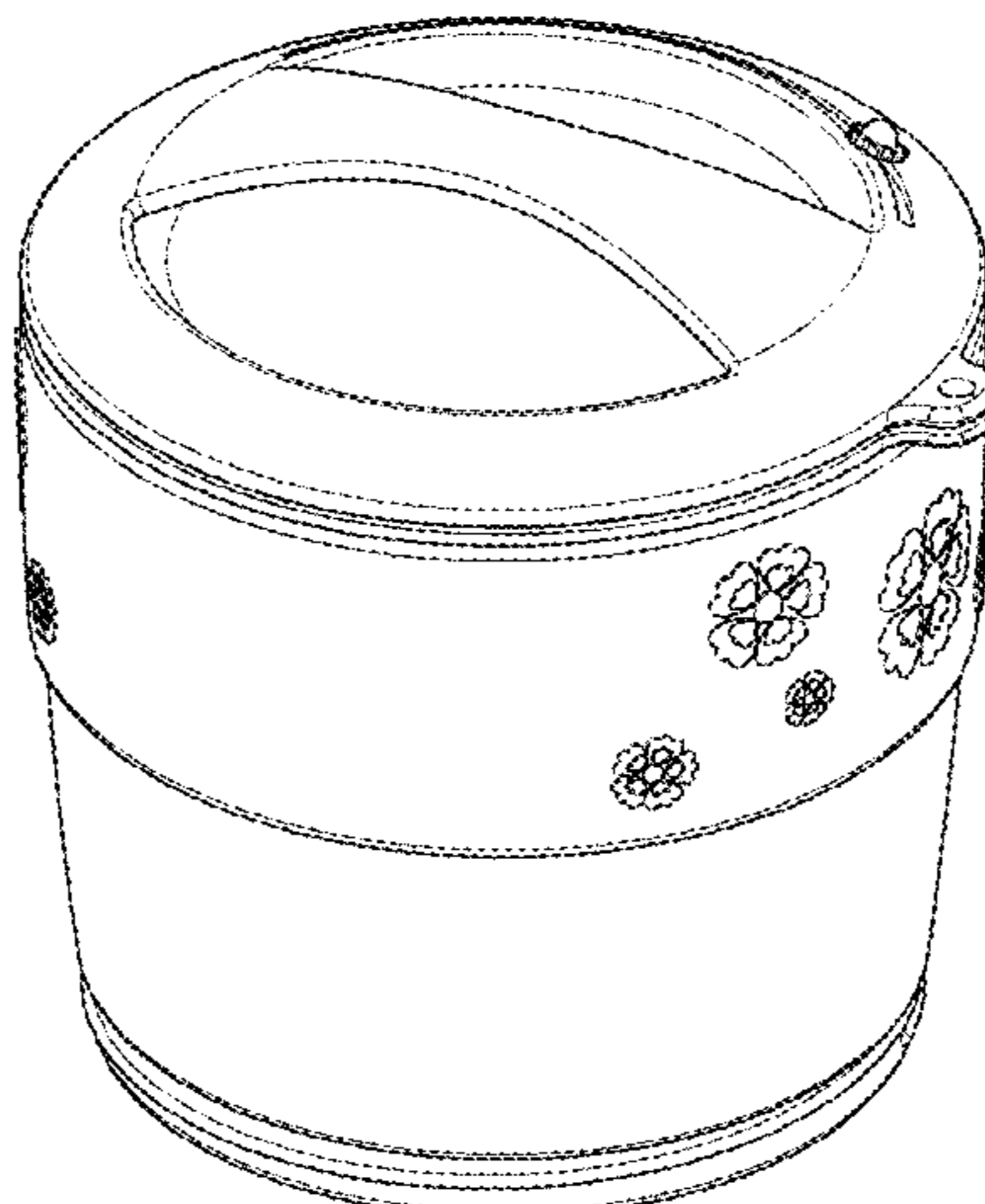

2.5 : Top
2.6 : Perspective
2.7 : Bottom

1 Claim, 14 Drawing Sheets

(56) **References Cited**

U.S. PATENT DOCUMENTS

D685,231 S * 7/2013 Lane D7/605
D686,885 S * 7/2013 Meyers D7/629

* cited by examiner

1.1

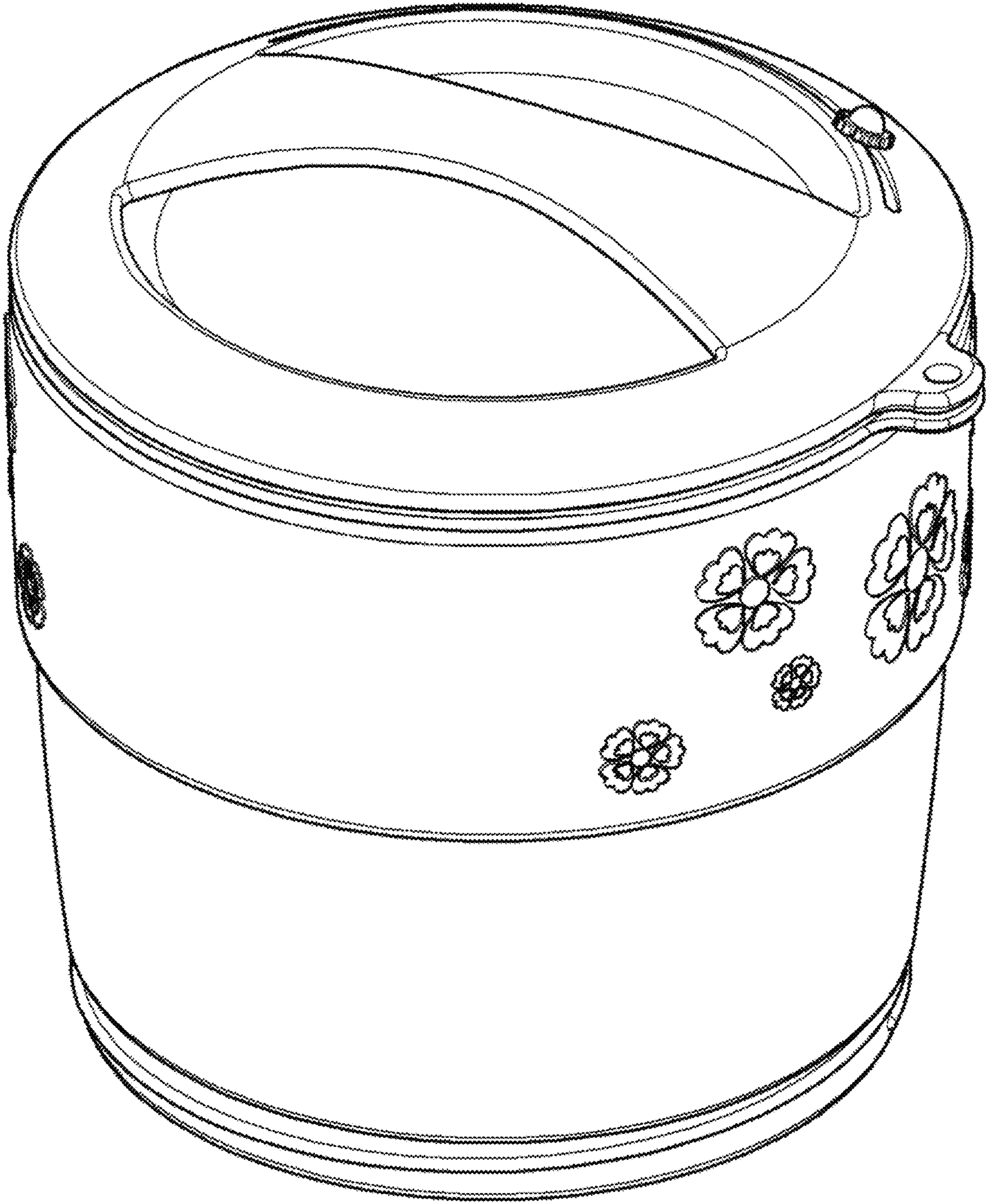

1.2

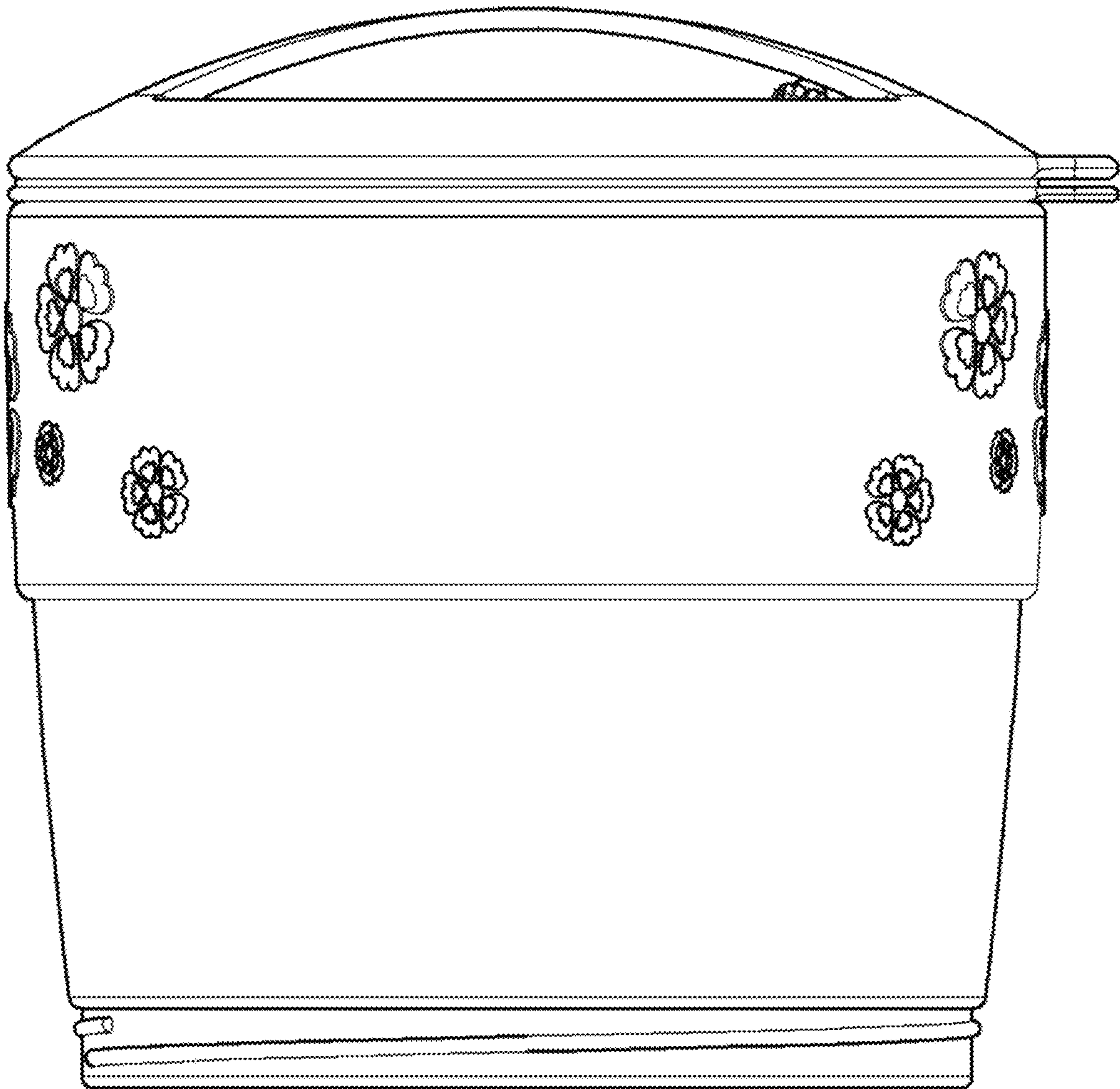

1.3

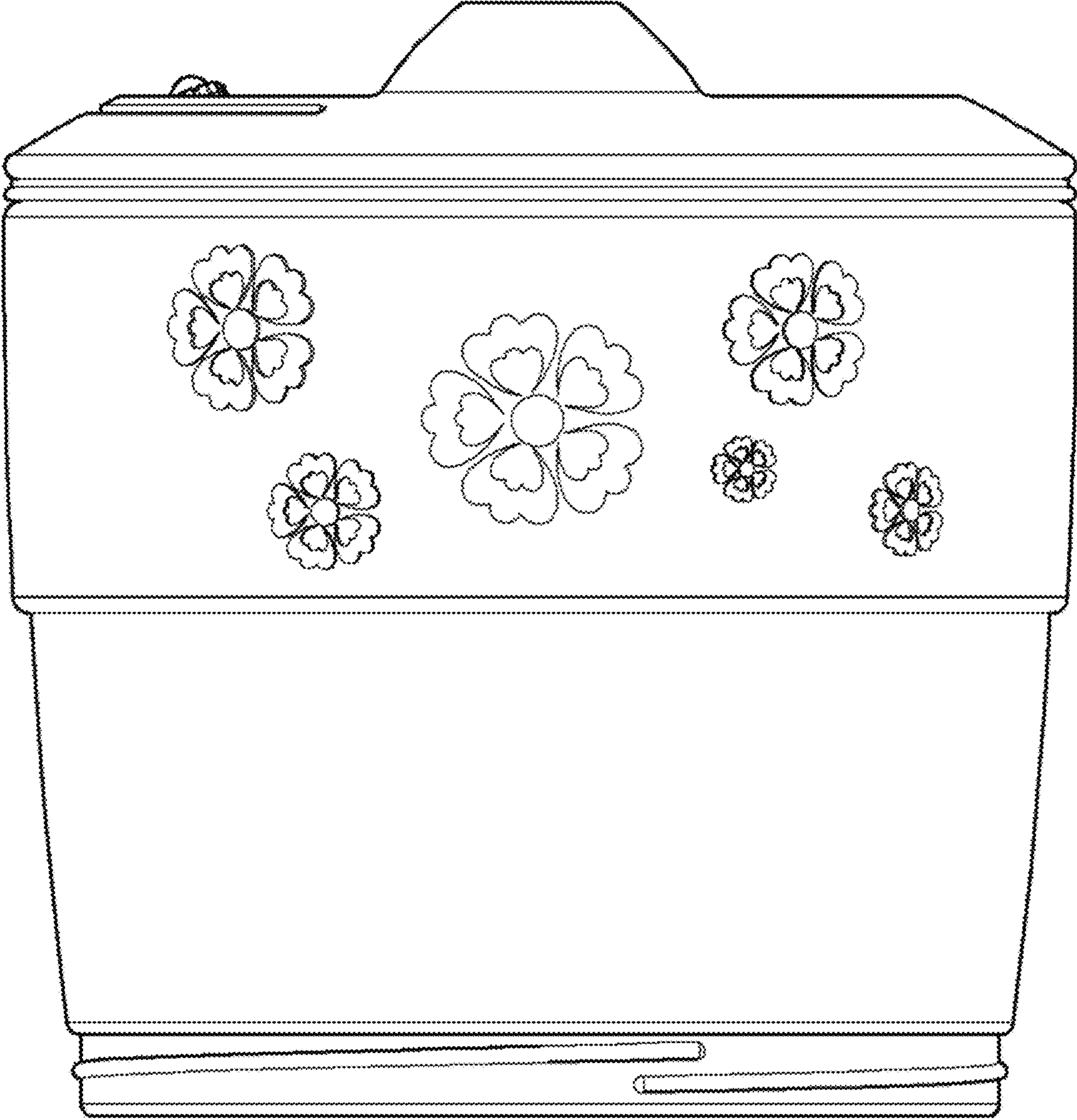

1.4

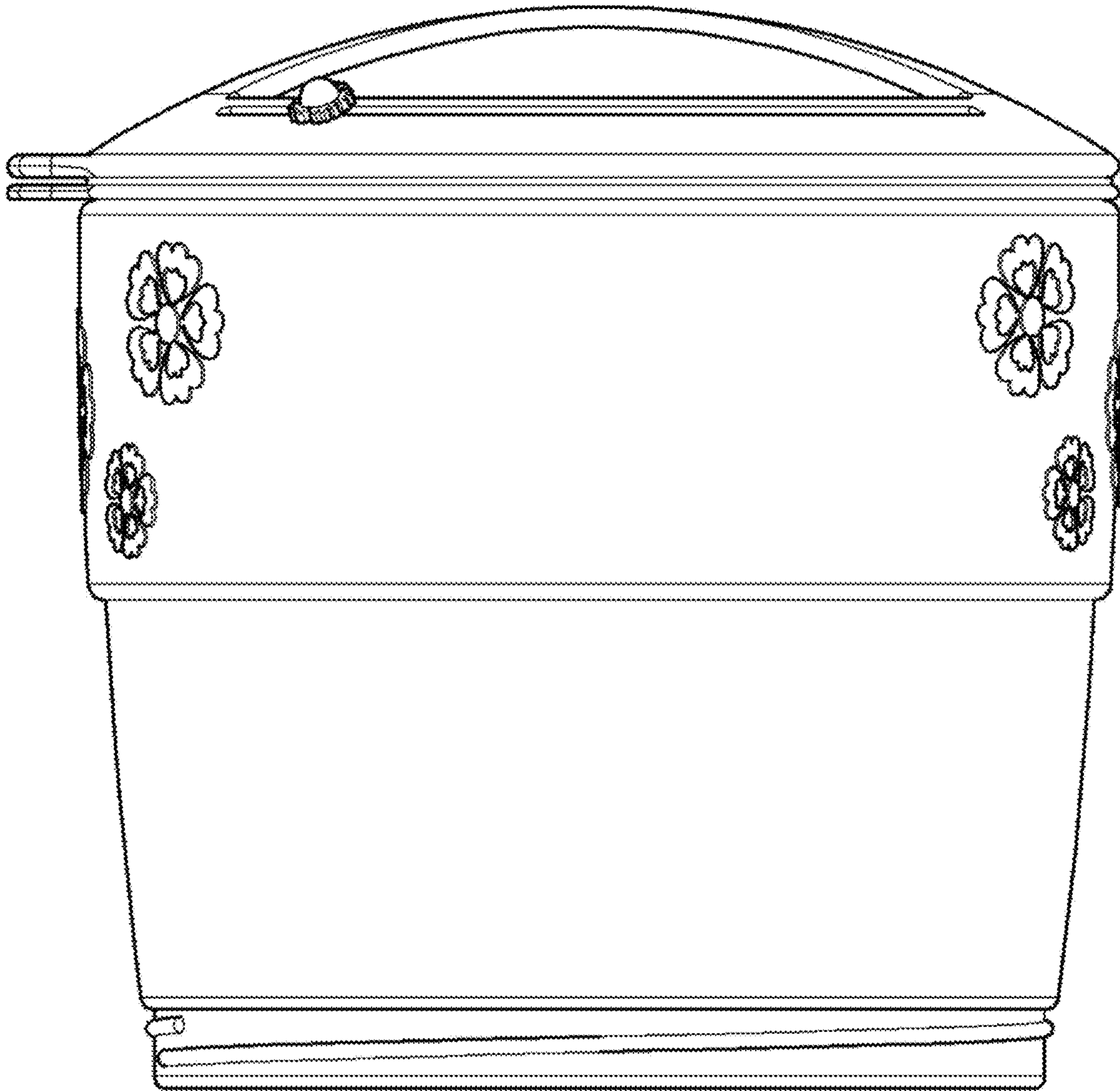

1.5

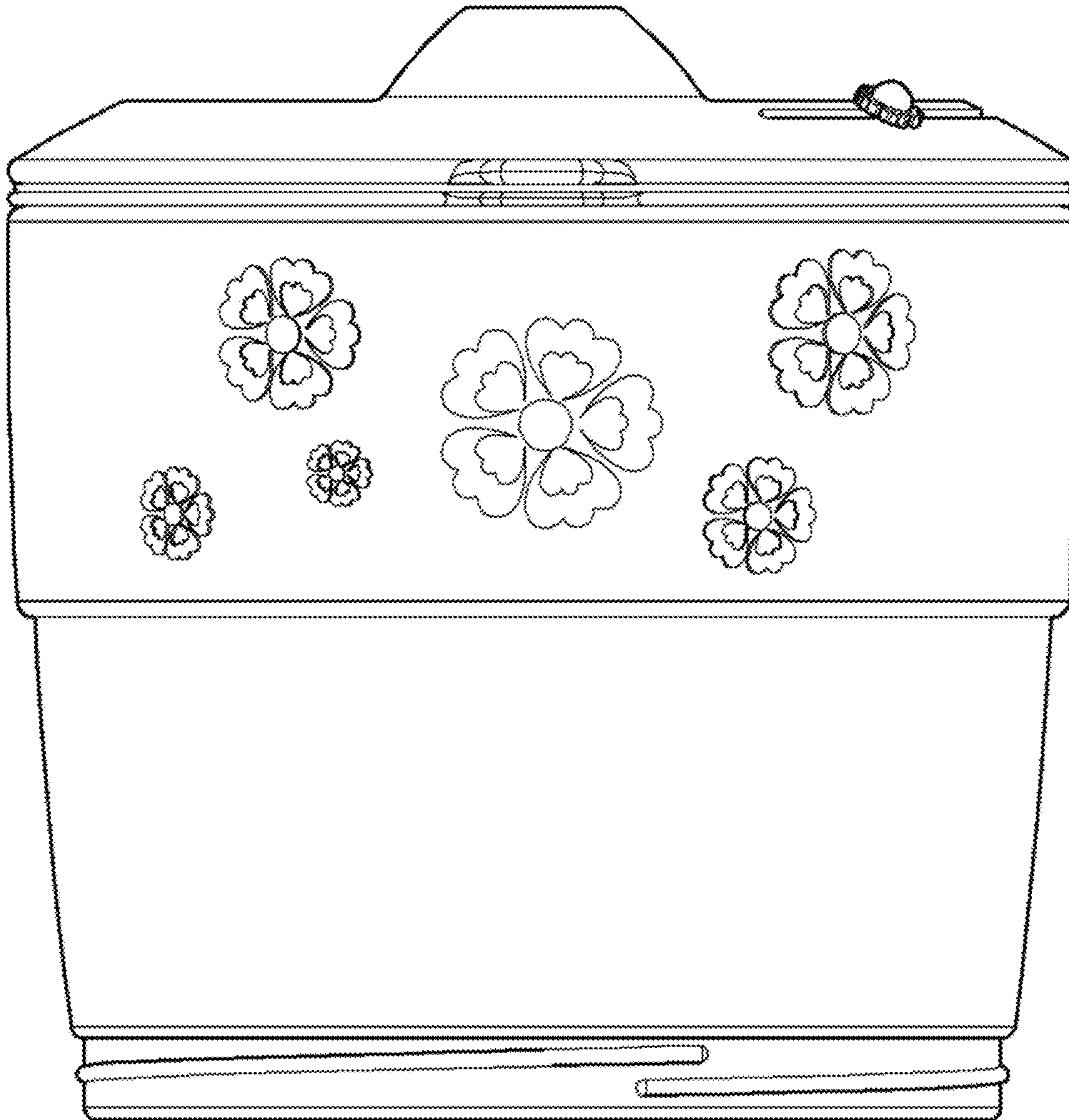

1.6

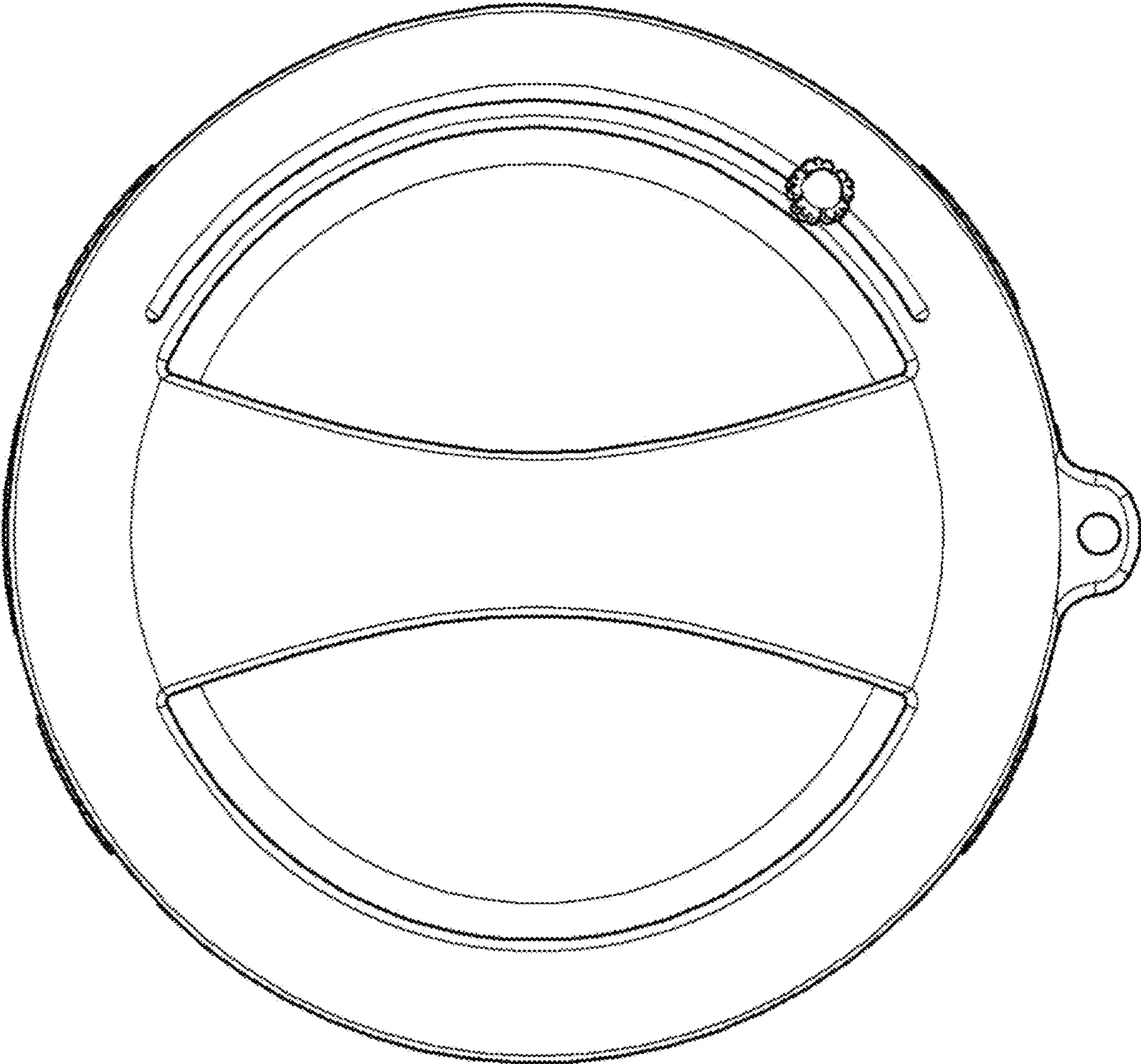

1.7

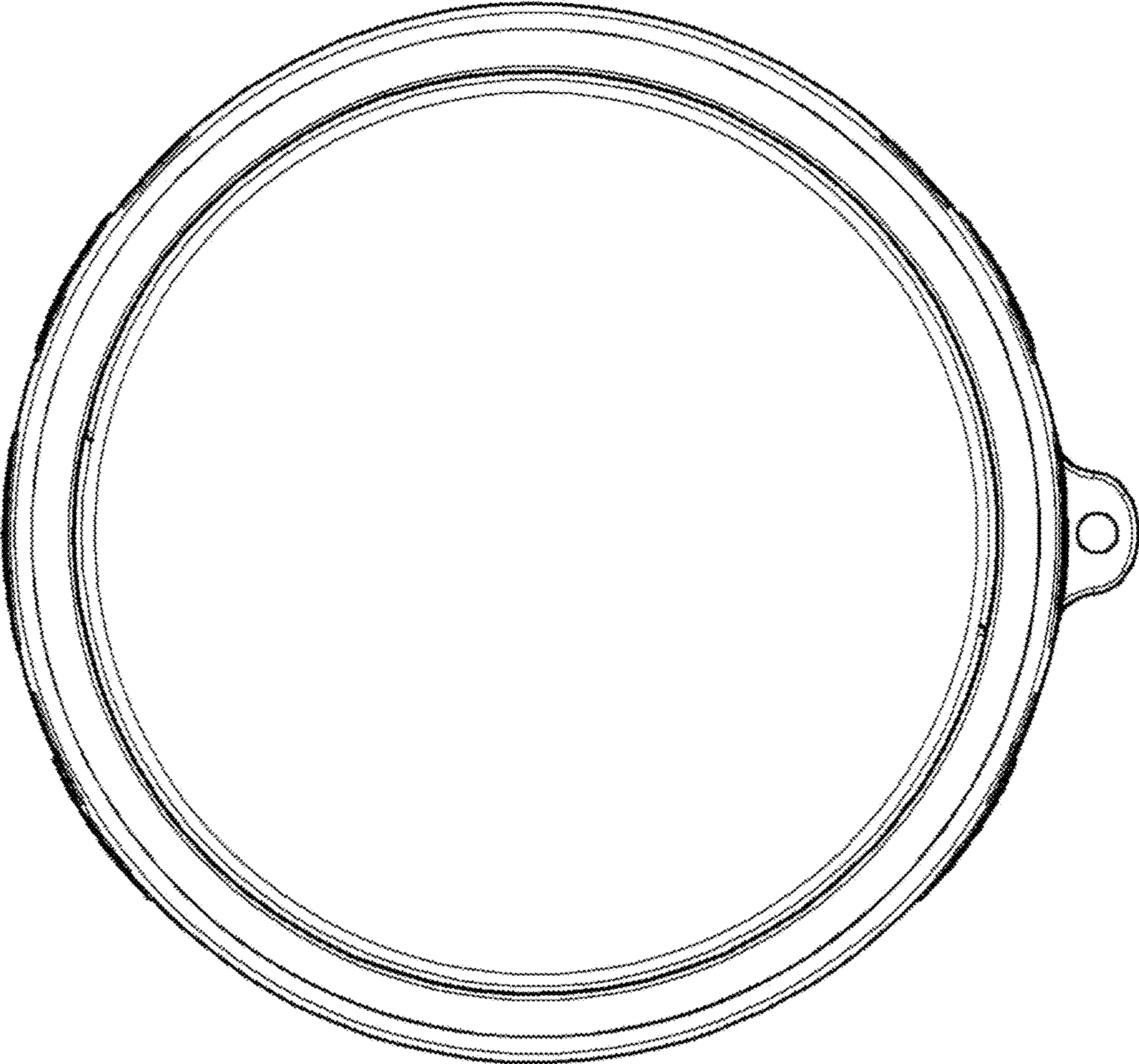

2.1

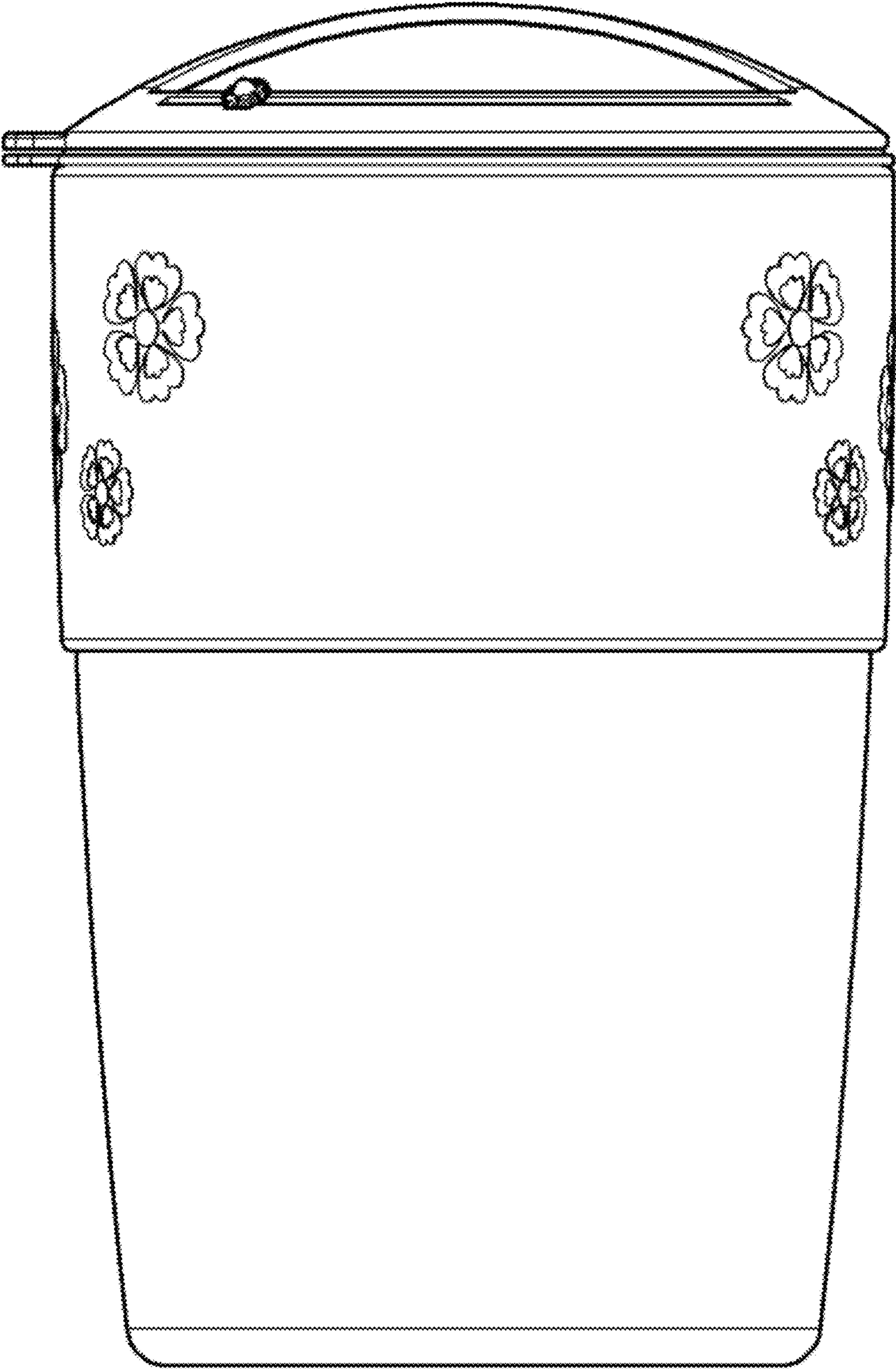

2.2

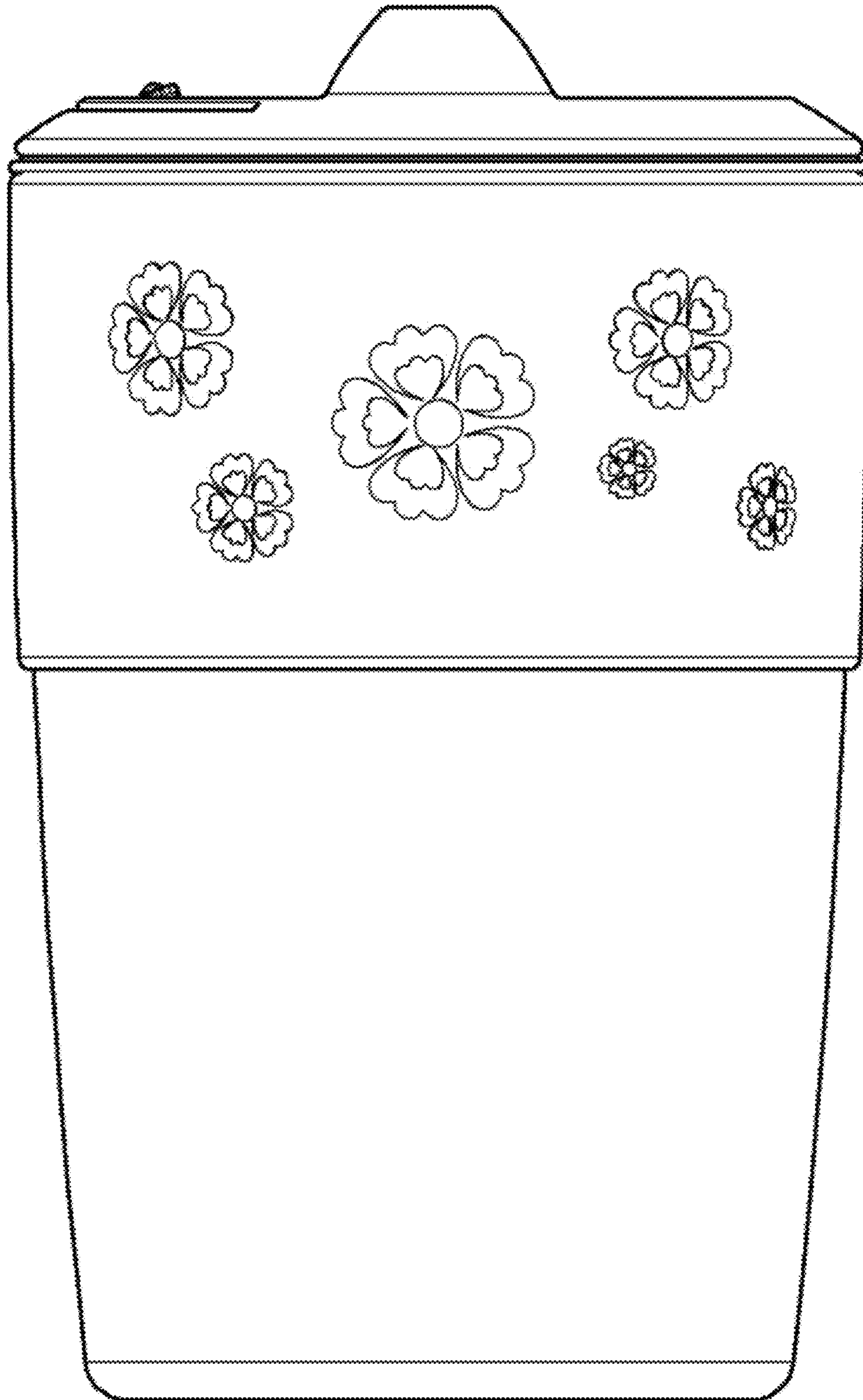

2.3

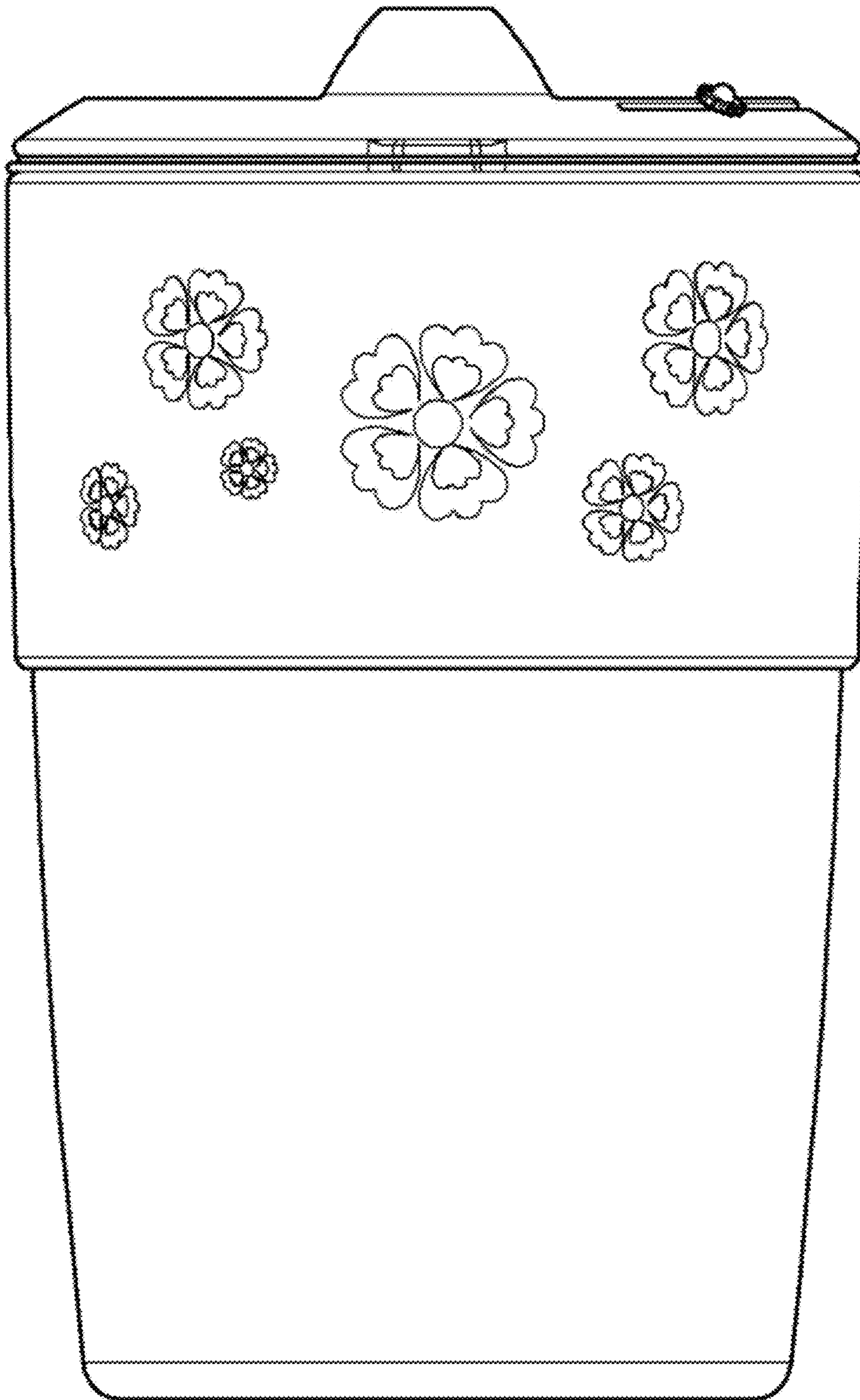

2.4

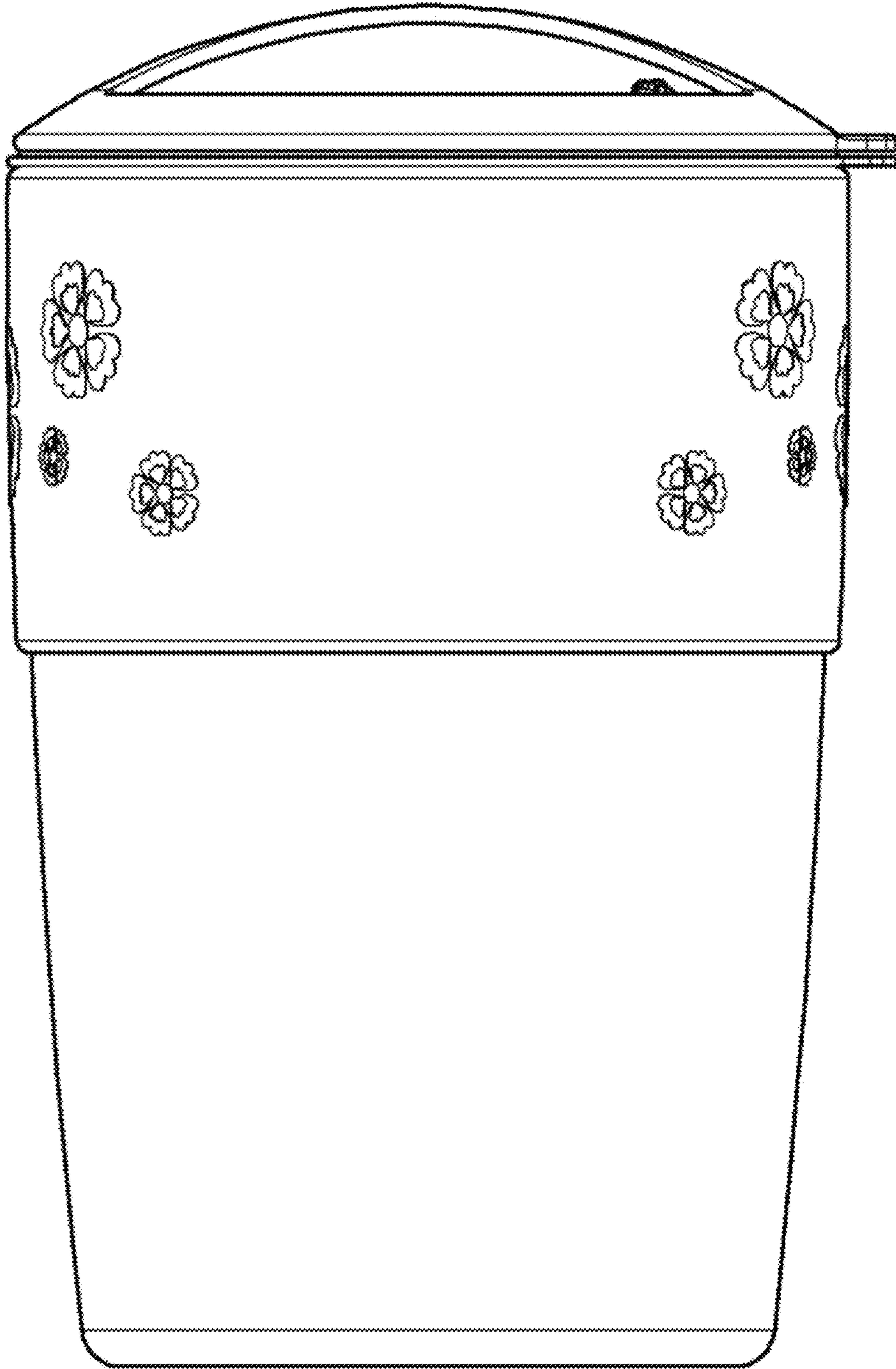

2.5

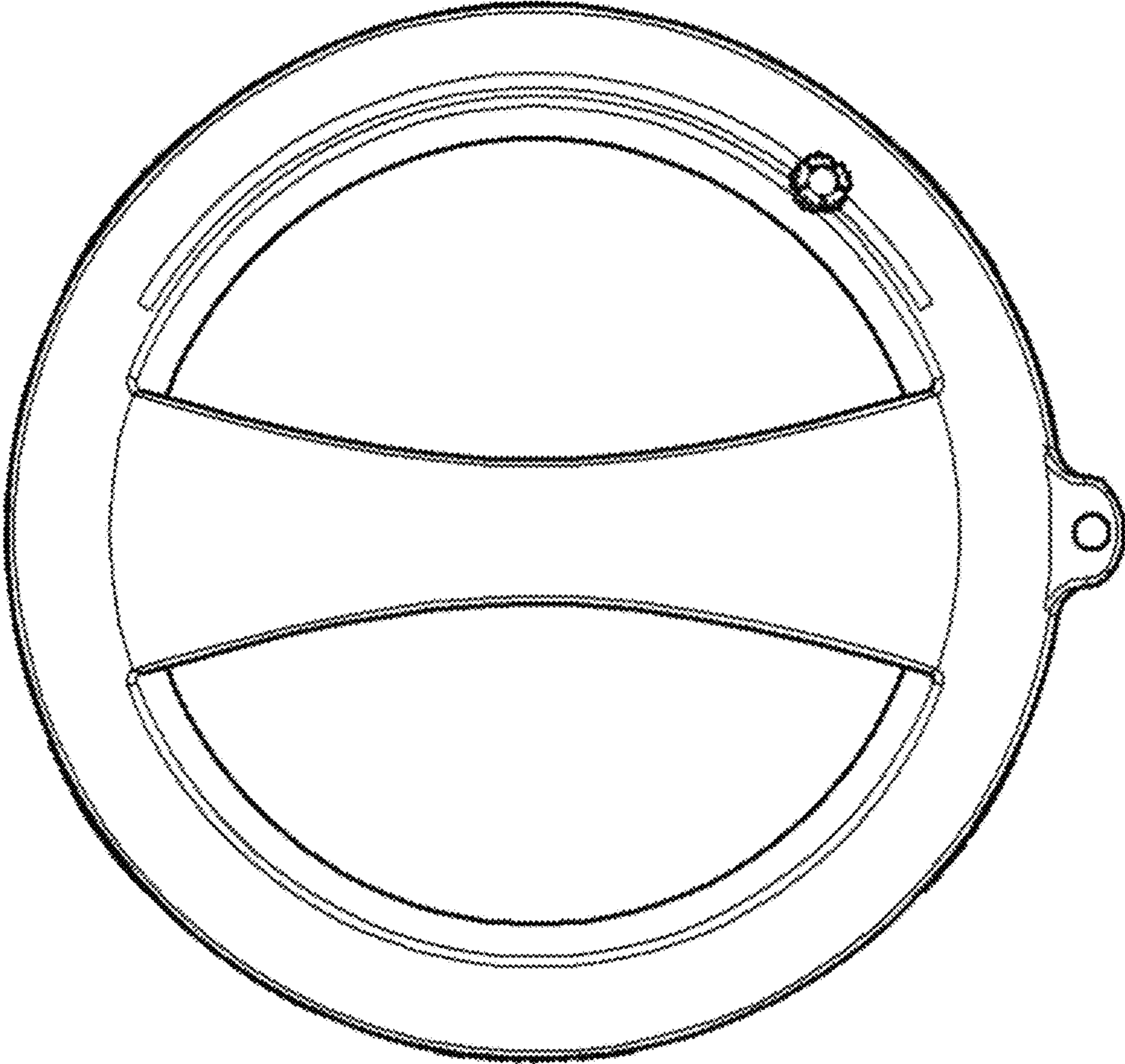

2.6

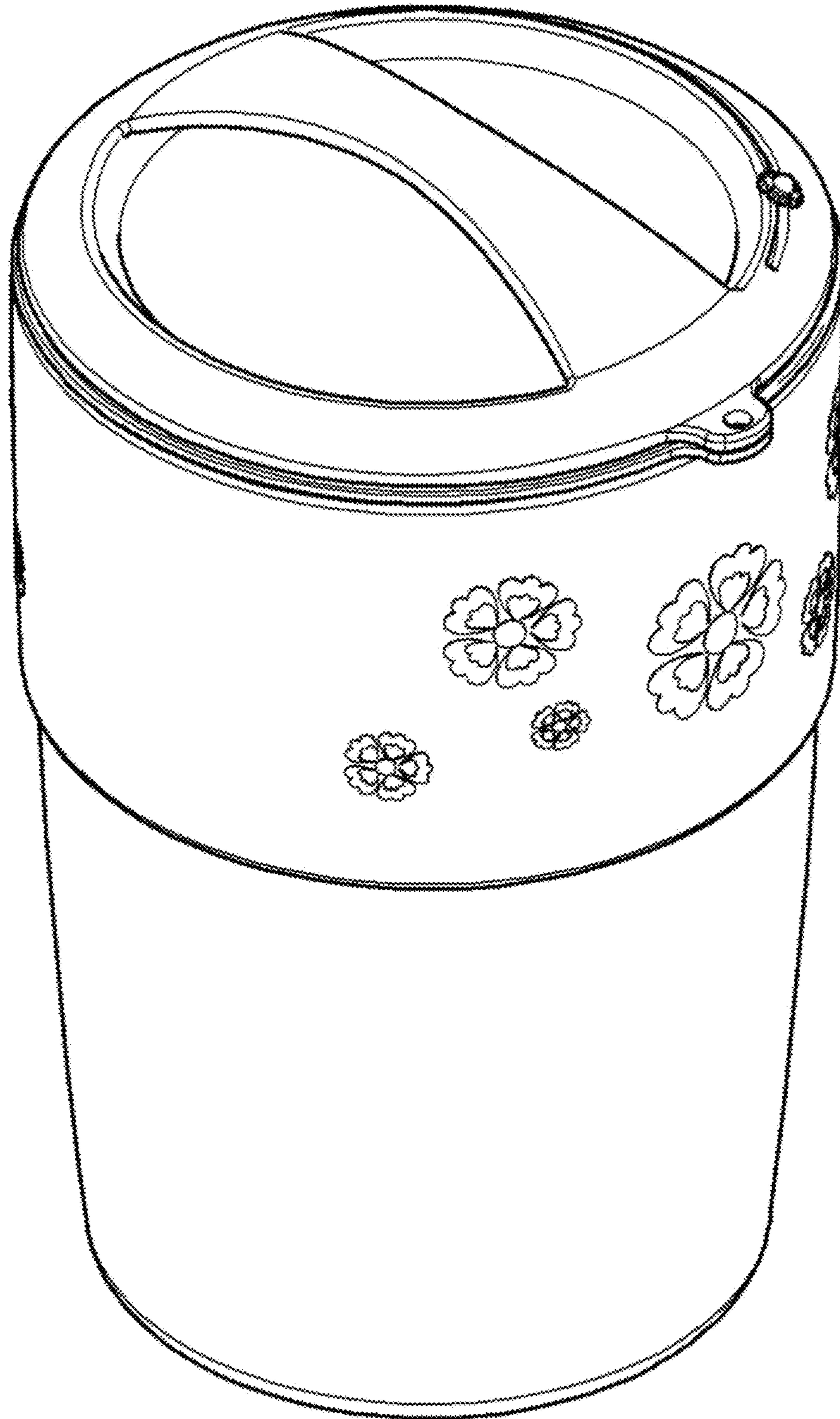

2.7

