



US00D798058S

(12) **United States Design Patent** (10) **Patent No.:** **US D798,058 S**  
**Miller** (45) **Date of Patent:** **\*\* Sep. 26, 2017**

(54) **SHOULDER GUARD FOR CARRYING BRICKS, PLYWOOD AND THE LIKE**

8,336,125 B2 12/2012 Elders et al.  
2008/0011547 A1 1/2008 Bonitto  
2013/0117916 A1 5/2013 Gomez

(71) Applicant: **Justin Thomas Miller**, Pocomoke, MD (US)

\* cited by examiner

(72) Inventor: **Justin Thomas Miller**, Pocomoke, MD (US)

*Primary Examiner* — Holly Baynham  
(74) *Attorney, Agent, or Firm* — Suzanne Kikel, Patent Agent

(\*\*) Term: **15 Years**

(57) **CLAIM**

The ornamental design for a shoulder guard for carrying bricks, plywood, and the like, as shown and described.

(21) Appl. No.: **29/620,015**

**DESCRIPTION**

(22) Filed: **May 23, 2016**

(51) **LOC (10) Cl.** ..... **03-01**

FIG. 1 is a perspective view of a shoulder guard for carrying bricks, plywood and the like in an operative position and showing my new design.

(52) **U.S. Cl.**  
USPC ..... **D3/327**

FIG. 2 is an enlarged, front elevational view of the shoulder guard for carrying bricks, plywood, and the like of FIG. 1.

(58) **Field of Classification Search**  
USPC ..... **D3/327**

FIG. 3 is a rear elevational view thereof.

CPC ..... **A41D 27/26; A41D 13/00**  
See application file for complete search history.

FIG. 4 is a left side elevational view thereof.

FIG. 5 is a right side elevational thereof.

FIG. 6 is a top view thereof; and,

FIG. 7 is a bottom view thereof.

The broken lines showing of a workman and plywood in FIG. 1 are included for the purpose of illustrating environment and form no part of the claimed design. The broken lines showing of the words bricks and plywood in FIG. 2 form no part of the claimed design.

(56) **References Cited**

**U.S. PATENT DOCUMENTS**

5,319,806 A \* 6/1994 Hermann ..... A41D 13/0512  
2/267  
6,101,637 A 8/2000 Lessard

**1 Claim, 7 Drawing Sheets**

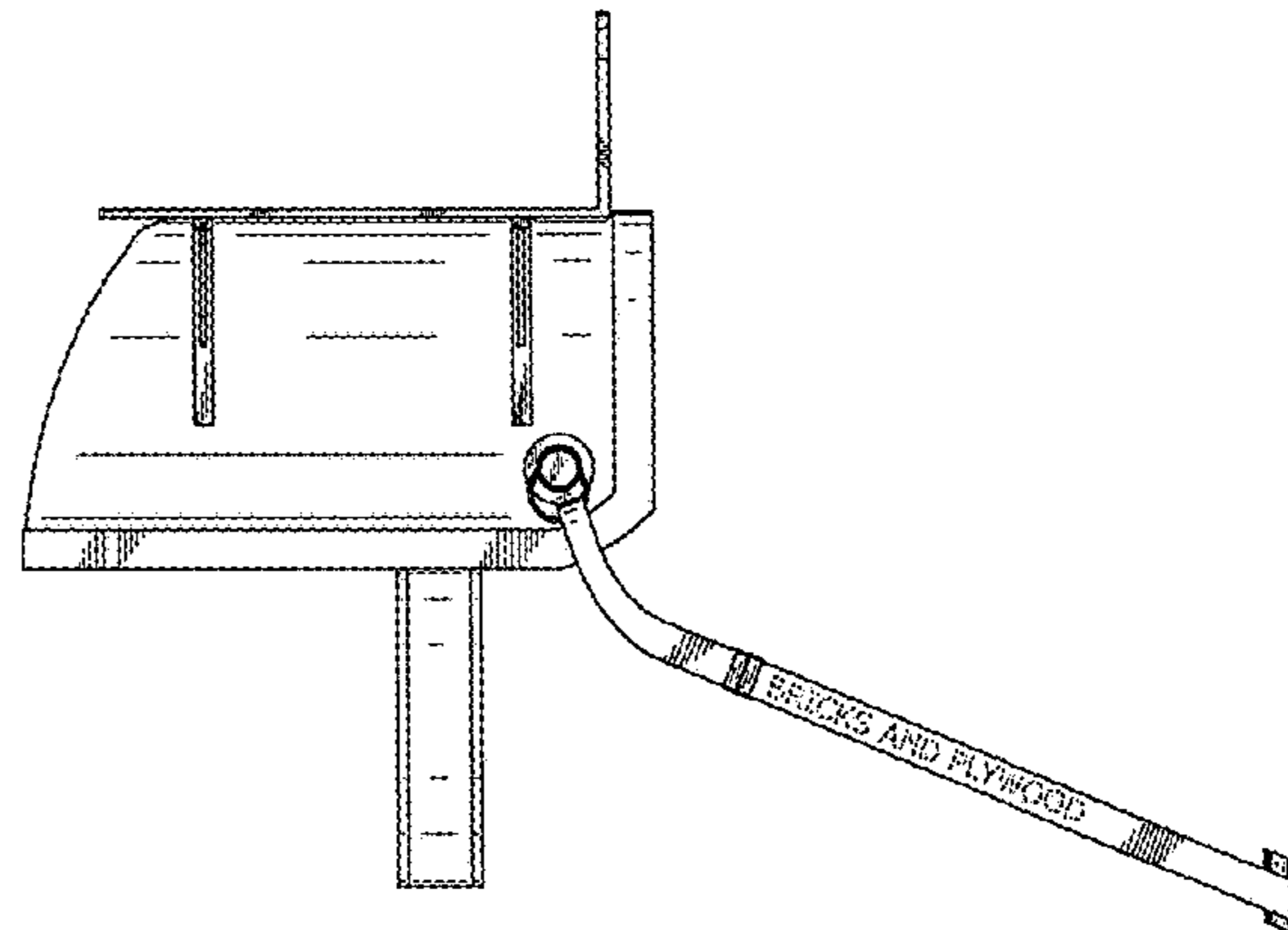
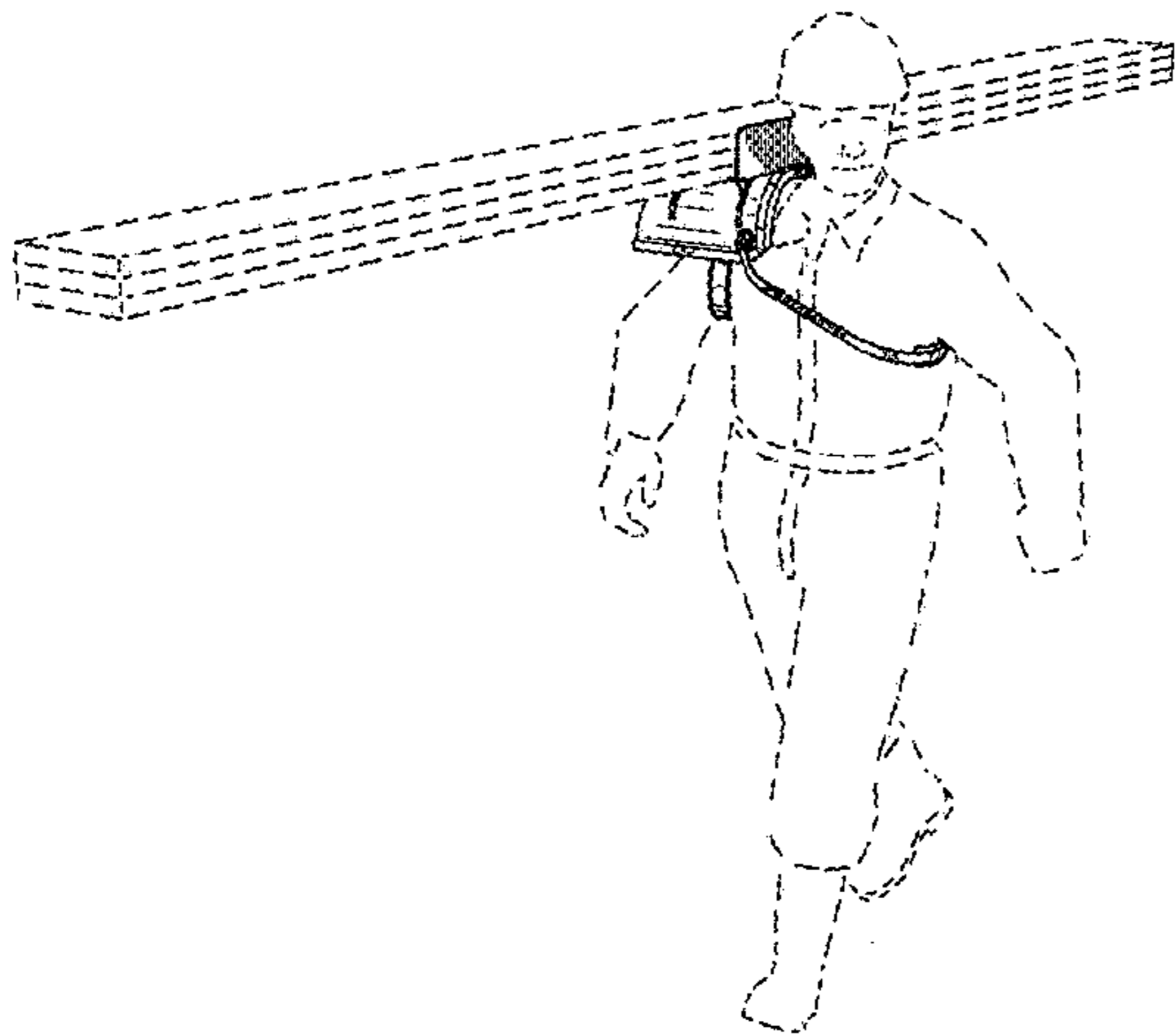

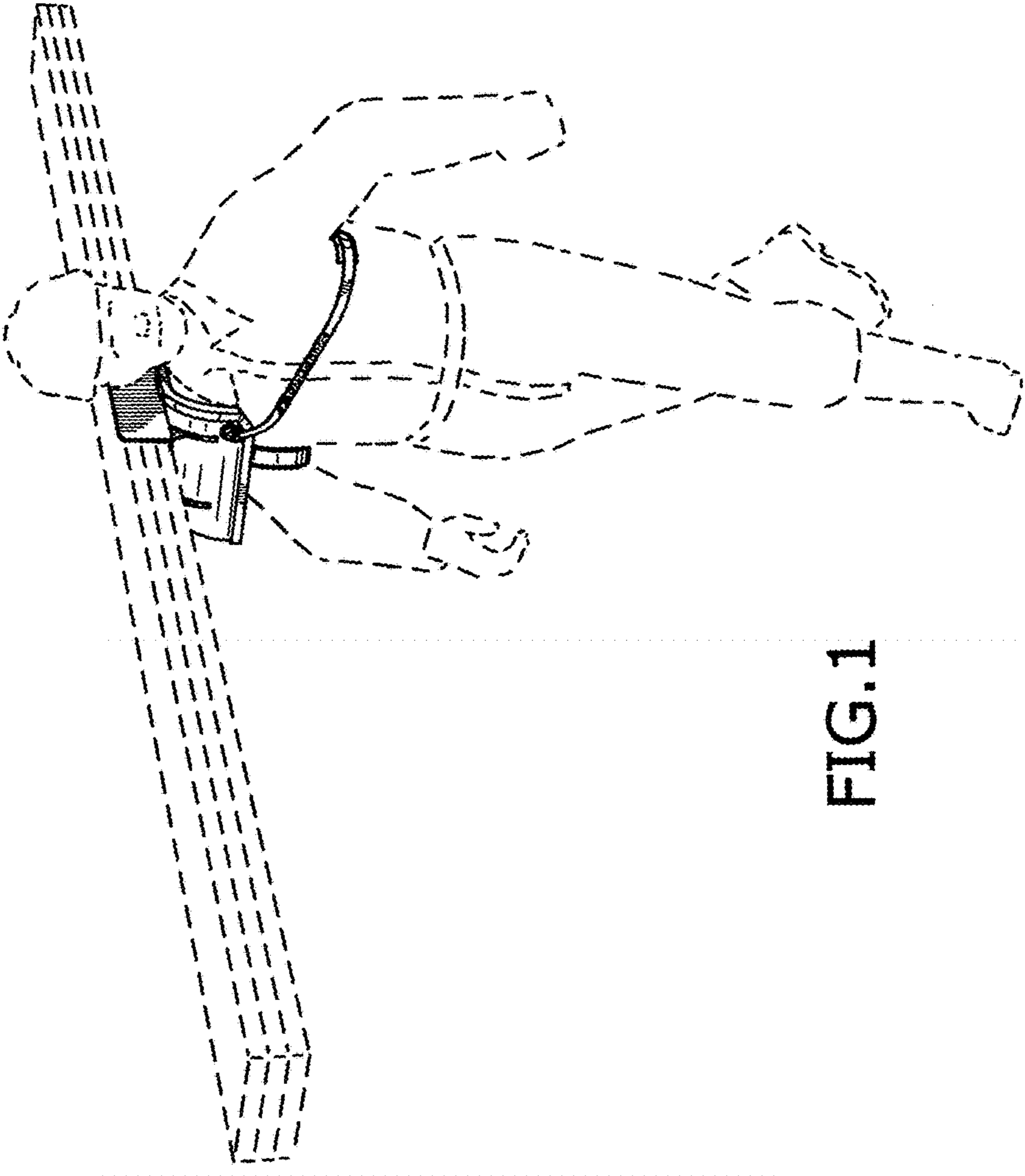

FIG. 1

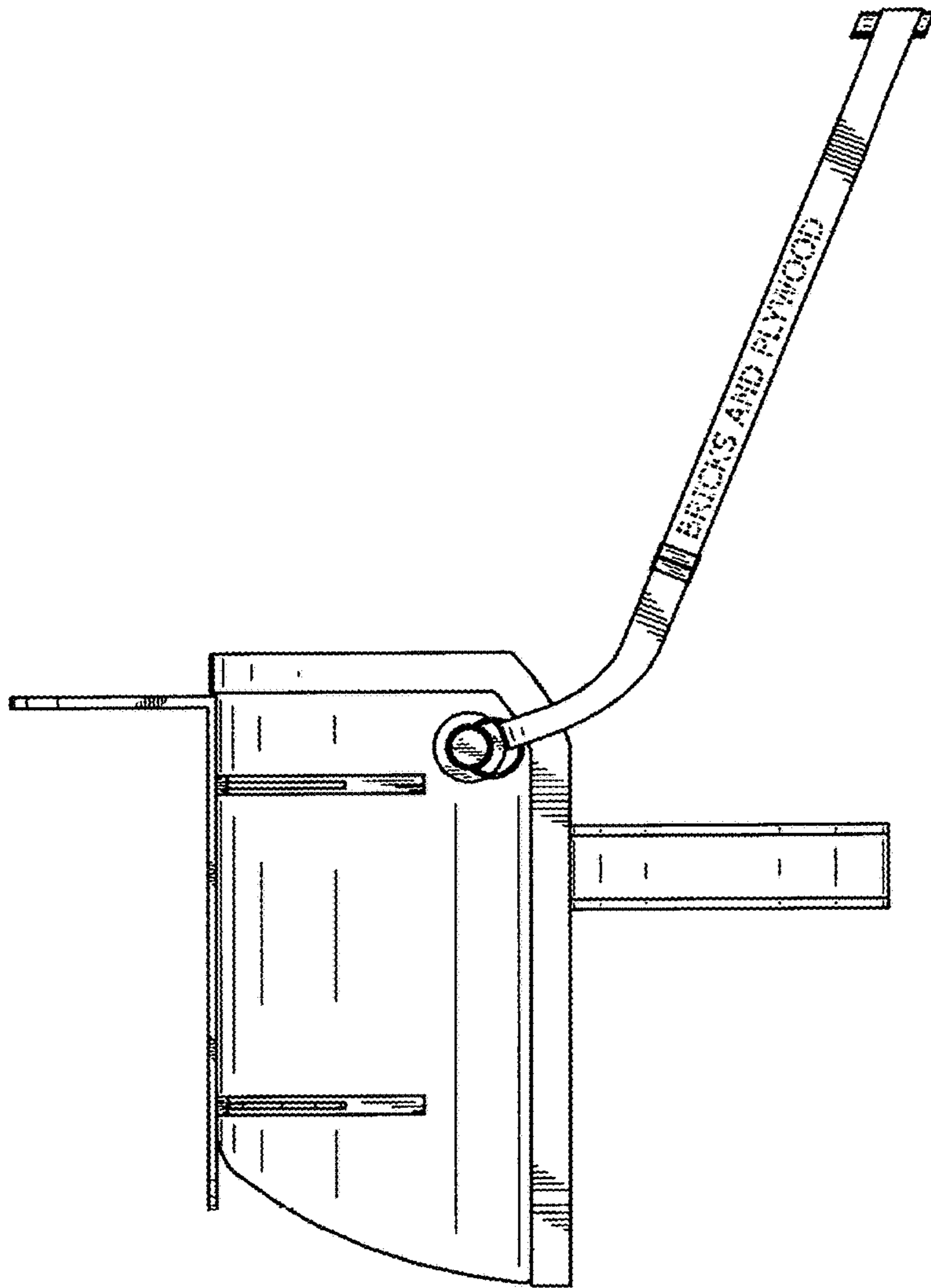

FIG.2

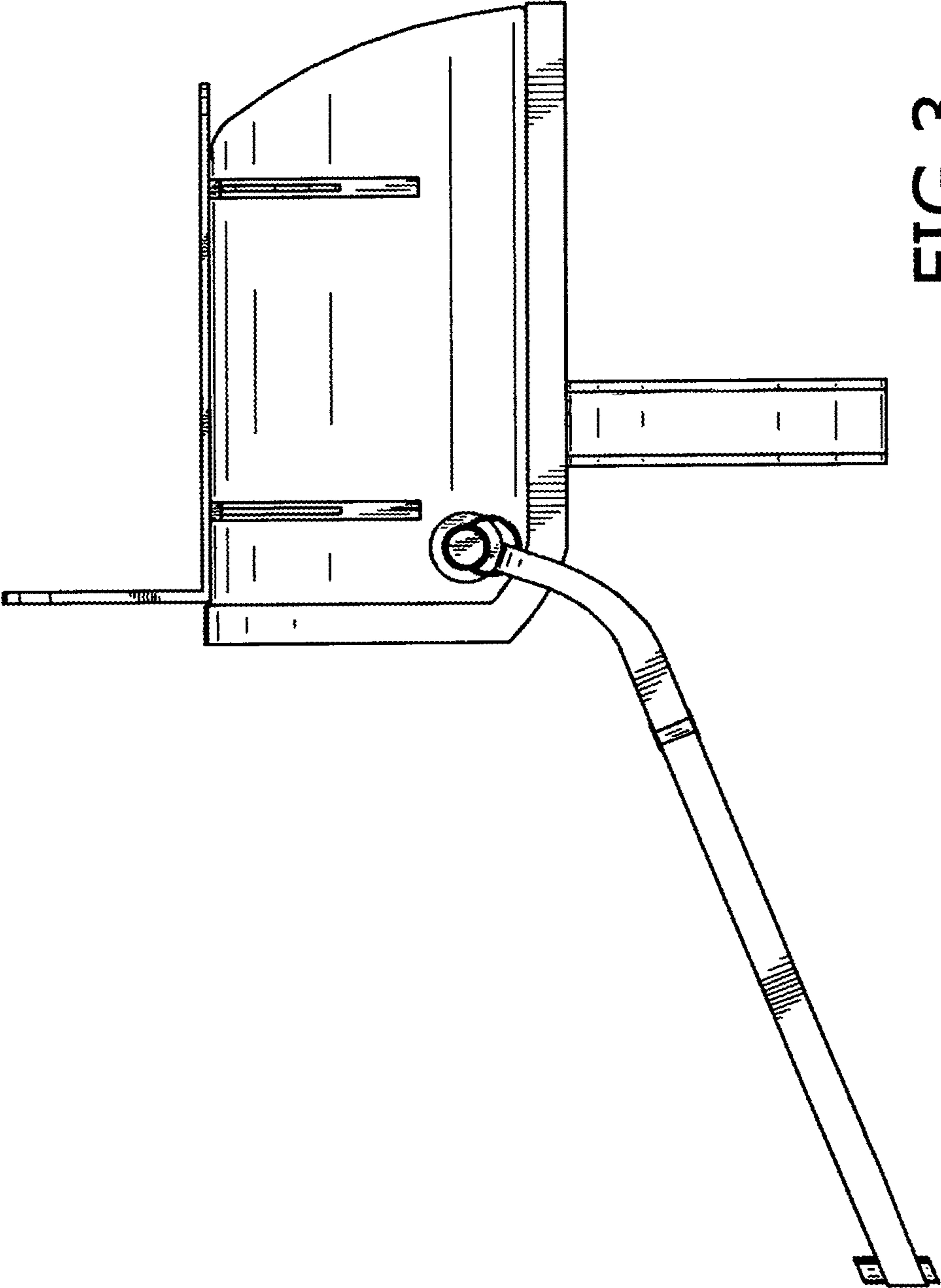

FIG. 3

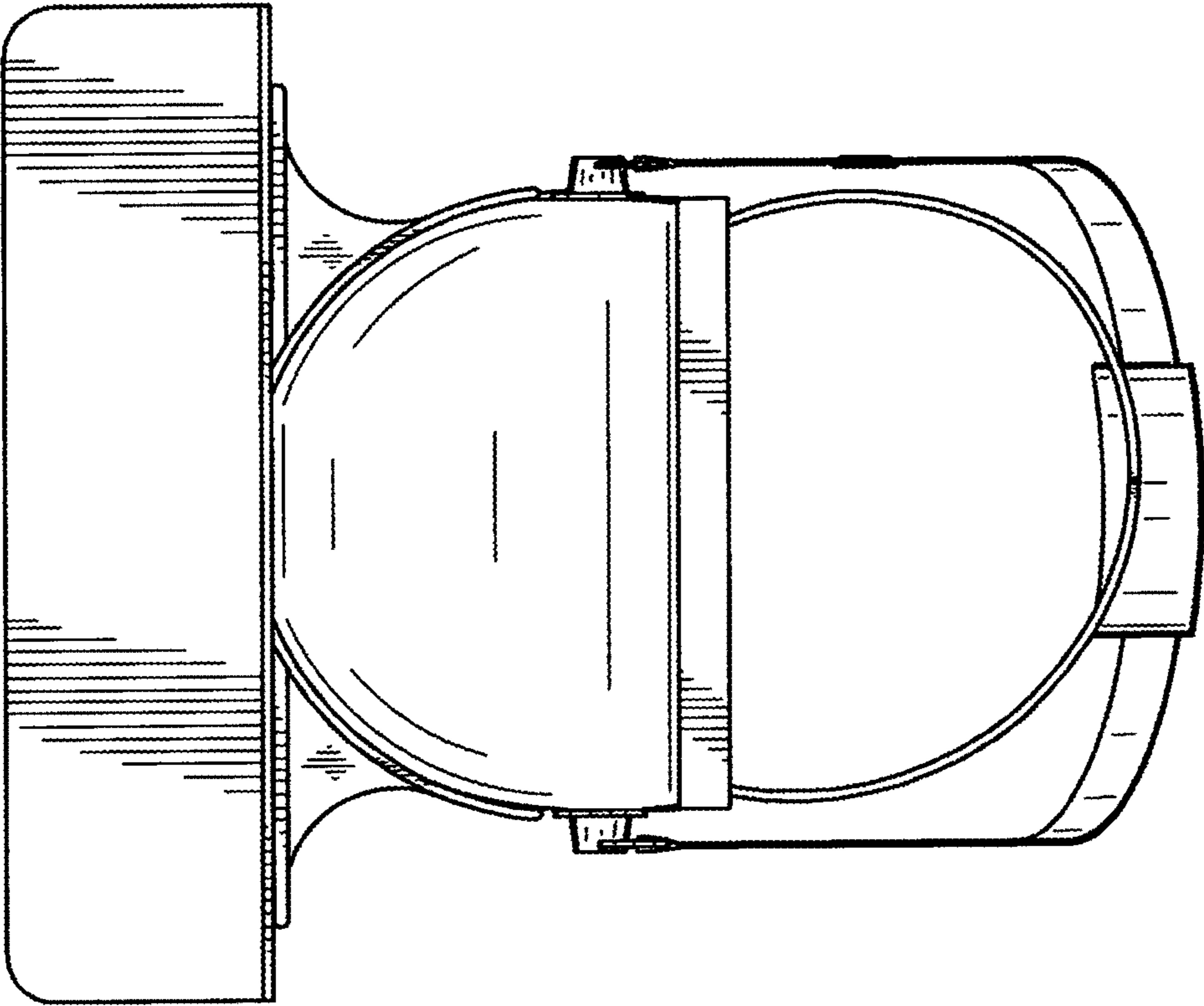

FIG.4

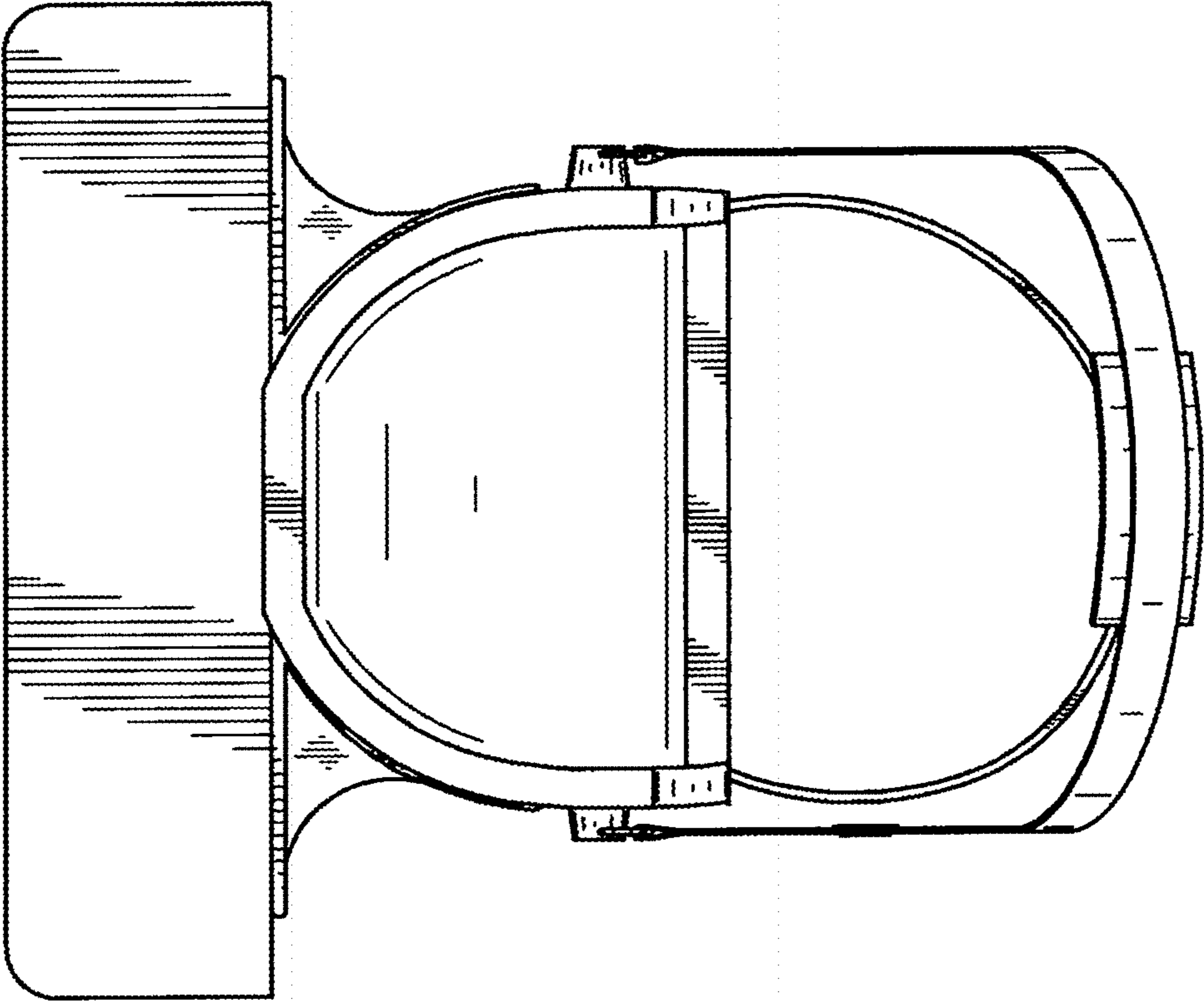

FIG. 5

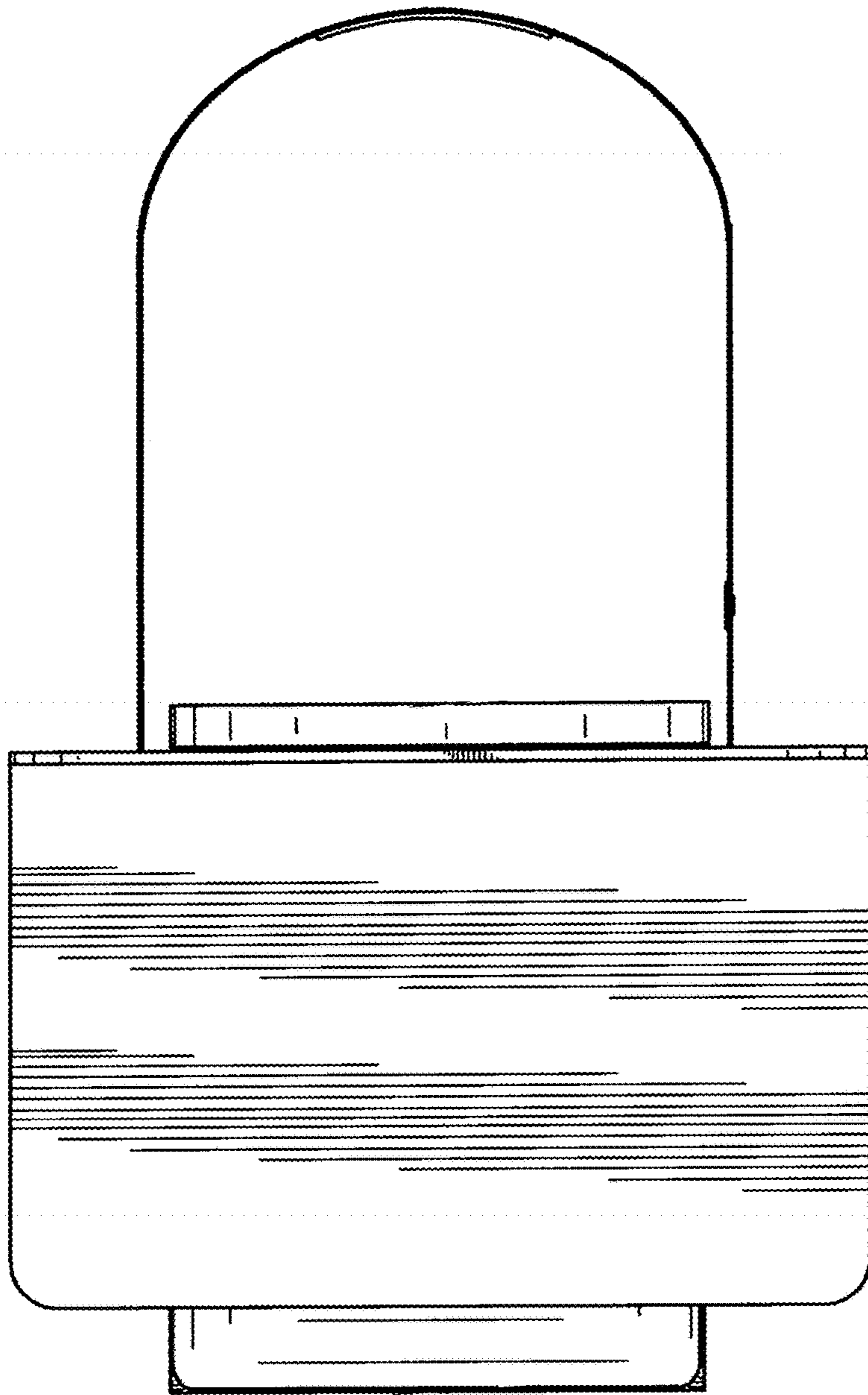

FIG.6



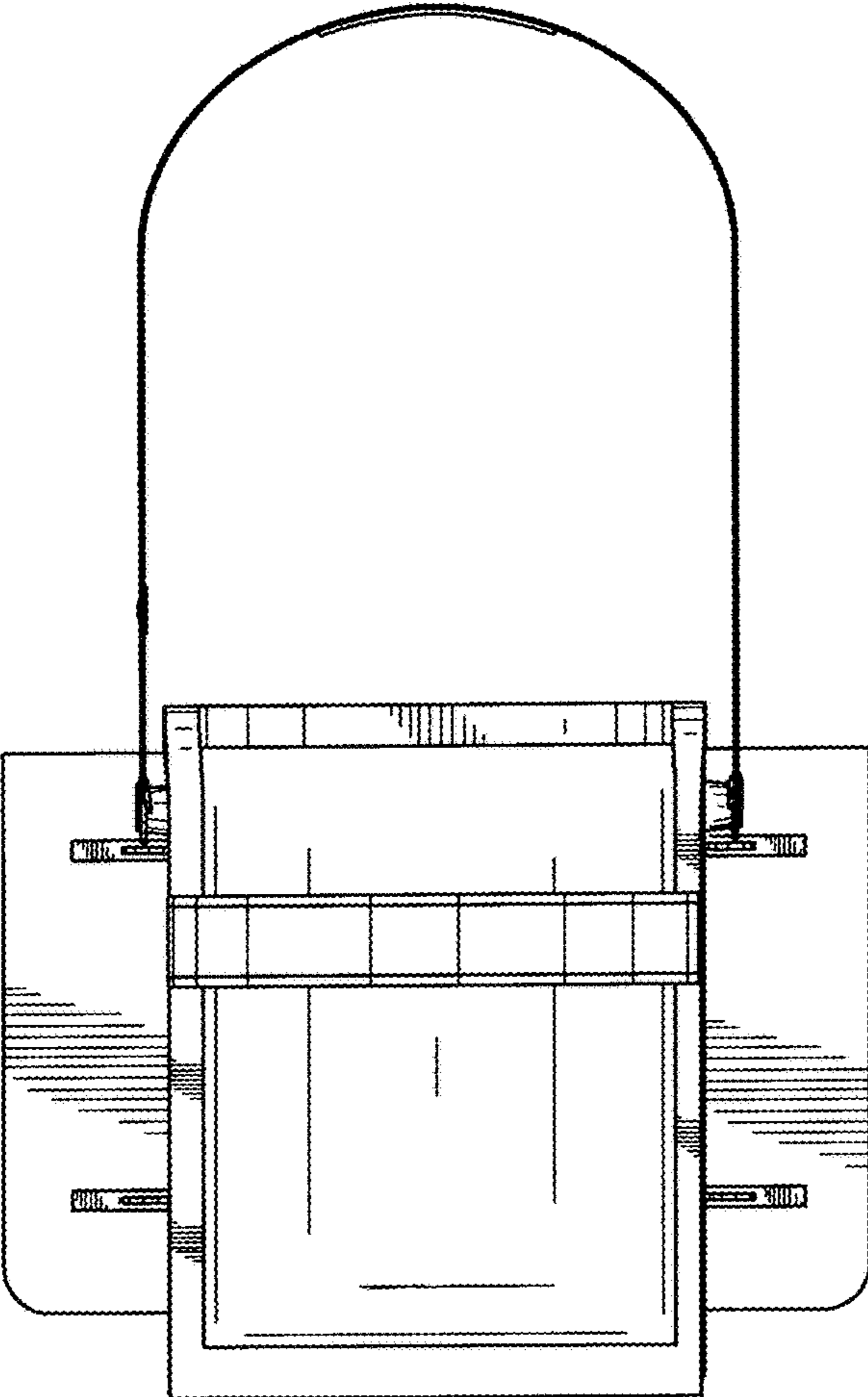

FIG.7